

# COMPLETE STREETS DESIGN AND CONSTRUCTION STANDARDS

*City of Edmonton*

Version 05  
COE-IM-GUIDE-0011

Date of Issue: August 31, 2023



## Disclaimer

This volume was developed for establishing standards and guidelines for the City of Edmonton's expectations in the design and construction of transportation infrastructure. Care has been taken to confirm the accuracy of the information contained herein. The views expressed herein do not necessarily represent those of any individual contributor. Transportation and related asset design continually evolves, and practices change and improve over time, so it is necessary to regularly consult relevant technical standards, codes, and other publications rather than relying on this publication exclusively. The City of Edmonton, authors, and members of the review committee, want to convey that this document does not constitute a project-specific design. As such, no part of this guideline alleviates the responsibility of the professionals retained to design and construct specific projects from taking full responsibility and authenticating their designs as required in accordance with AALA, APEGA, AAA, Alberta Building Code, and any other statutory or safety requirements.

Any Standard Drawings, Details, or specifications are provided to convey the City's typically ideal general arrangement and requirements. Representations may not be to scale, they may be substantially schematic in nature and/or require further elaboration and development. As such those documents are not suitable for integration into a specific implementation without review and modification and are only intended for use by a competent designer exercising professional judgement. The designer shall modify and supplement as necessary to provide a complete, properly functioning design that conforms in all respects to the City's functional requirements. When actualized in a particular implementation it is the designer's responsibility to ensure the size, location, and spacing of all elements, and all components/specifications, are suitable and safe for the use and location intended, and any applicable code, legislative, and authority requirements are adhered to. In addition, any accessibility, operational and maintenance requirements must be met. Deviations from the represented nominal design parameters, questions of intent or accuracy, or any other apparent conflicts, shall be reconciled with an appropriate City representative. Finally, when employing any aspect of these documents, the ultimately responsible professional designer shall remove any authentication of the original author(s), note any provenance as appropriate, and apply their own authentication as required.

### **Important Note:**

Printed or downloaded copies of this document are not controlled and may not be the current version.

Authentication Table

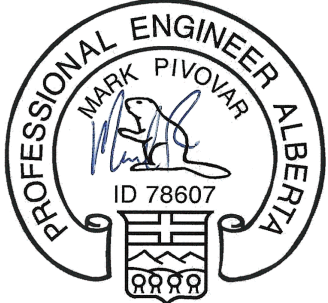
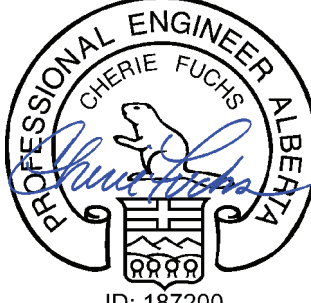
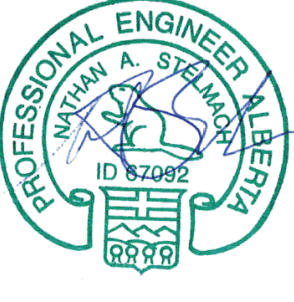
<p><b>Complete Streets Design and Construction Standards</b> Sections: 1 - 6 Appendices: A - F</p> <p><b>Complete Streets Standard Drawings</b> Section 1000 - Utility Cut Restoration (All) Section 2000 - Cross-Sections (2000-2031, 2042-2730) Section 3000 - Design Details (3000-3040, 3500 - 3540, 3700 - 3720, 3900) Section 4000 - Transit Details (All) Section 5000 - Construction Details (5000-5524, 5600-5700)</p>	<p><b>Mark Pivovar, P.Eng.</b> General Supervisor, Development Engineering And Drawing Review</p>	 <p>2023-Sep-08</p>
<p><b>Complete Streets Construction Specifications</b> Sections: 1.1, 1.2, 2.1, 4.4, 6.1, 6.2, 6.7 - 6.9, 6.11, 7.1, 7.3, 7.7, 7.11 Section 2000 - Cross-Sections (2040, 2041) Section 3000 - Design Details (3800-3845)</p>	<p><b>Cherie Fuchs, P. Eng.</b> General Supervisor, Construction Materials Engineering and Testing (CMET)</p>	 <p>ID: 187200 2023-Sep-07</p>
<p><b>Complete Streets Construction Specifications</b> Sections: 2.2 - 4.3, 4.5 - 5.3, 6.3 - 6.6, 6.10, 7.2, 7.4 - 7.6, 7.8 - 7.10, 7.12 - 8.4</p>	<p><b>Nathan Stelmach, P. Eng.</b> General Supervisor, Transportation Infrastructure Delivery</p>	 <p>2023-10-13</p>

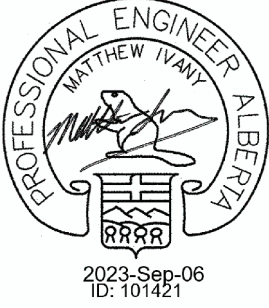
<p><b>Complete Streets Standard Drawings</b>                  Section 3000 - Design Details (3100-3400)                  Section 5000 - Construction Details                  (5530-5531)                  Section 6000/7000 Miscellaneous Details                  (All)</p>	<p><b>Matthew Ivany,                  P.Eng.</b>                  General                  Supervisor,                  Transportation                  Design</p>	
<p><b>Permit to Practice - Entire Document</b></p> <p><b>Complete Streets Design and                  Construction Standards (All)</b></p> <p><b>Complete Streets Construction                  Specifications (All)</b></p> <p><b>Complete Streets Standard Drawings                  (All)</b></p>	<p><b>Natalie Lazaruko,                  P. Eng</b>                  Director,                  Transportation                  Planning And                  Design</p>	<div style="border: 1px solid black; padding: 5px;"> <p align="center"><b>PERMIT TO PRACTICE                  CITY OF EDMONTON</b></p> <p>RM SIGNATURE: <u>Natalie Lazaruko</u> Natalie Lazaruko</p> <p>RM APEGA ID #: <u>93519</u></p> <p>DATE: <u>2023-Oct-15</u></p> <p><b>PERMIT NUMBER: P005038</b>                  The Association of Professional Engineers and                  Geoscientists of Alberta (APEGA)</p> </div>

# CHANGE HISTORY

<i>Version</i>	<i>Change</i>	<i>Date</i>
05	Adding Chapter 2 (Construction Specifications) and Chapter 3 (Standard Drawings) to Front-Matter Table of Contents	August 2023
05	Correcting spelling errors and typos throughout all three chapters	August 2023
05	Changes instances of "Shared-Use Path" to "Shared Pathway"	August 2023
05	Changes "1.8.2.1 Modal Priority Areas" to "1.8.2.1 Establishing Modal Priority" and updates the modal priority areas based on most recent planning documents	August 2023
05	Adding guidance on designing for "interested but concerned" cyclists in section 3.1.3.2	August 2023
05	Adding minimum width for active mode connections on bridges in section 3.1.3.2	August 2023
05	Changes the bike facility categories in Table 3.4 to be consistent with The Bike Plan	August 2023
05	Adding "Curbside Activity and Access Management," "Posted Speed and Traffic Volumes," and "Pedestrian Volumes" to section 3.2.3.1 Selection of Suitable Bikeways	August 2023
05	Updates "Bicycle Boulevard" to "Local Street Bikeway"	August 2023
05	Adding design user impacts to section 3.2.3.2 Bikeway Facility Design Domain	August 2023
05	Updates bike facility categories and design domains in Table 3.8 Design Domain: Protected Bike Lanes, as well as explanation associated with the table.	August 2023
05	Adding explanation of the bike lane buffer width in section 3.2.3.2 Bikeway Facility Design Domain	August 2023
05	Updates bike facility categories and design domains in Table 3.9 Design Domain: Protected Bike Lanes	August 2023
05	Updates bike facility categories and design domains in Table 3.10 Design Domain: Shared-Use Paths and Bike Paths	August 2023
05	Adding target values to Table 3.14 Design Domain: Gradients	August 2023
05	Adding requirement for concrete header for curb extensions with landscaping in section 3.3.1.5 Curb Extensions	August 2023
05	Updating "Figure 3.40A: Driveway crossing of a separated sidewalk" to be consistent with standard drawing 5320	August 2023
05	Updating the normal longitudinal grade of the walkways from 0.7% to 0.6% in section 3.5.7 Vertical Alignment to be consistent with Appendix C	August 2023
05	Adding control vehicle columns to Tables 3.26 and 3.27	August 2023
05	Adding detail to Tactile Devices in Table 3.28 Curb Ramp Design Requirements	August 2023
05	Adding section 3.6.4.2 Crosswalk Enhancement Measures and section 3.6.4.3 Raised Crossings	August 2023

05	Adding section 6.6.8.1.1 High Entry Angle	August 2023
05	Removes Type 3 backfill from Construction Specifications and clarified granular for use in Type 2 backfill	August 2023
05	Updates Table 3.1.2: Moisture Content Requirements	August 2023
05	Deleting Sections 1.2.8 - 1.2.18 in Construction Specifications	August 2023
05	Adds minor clarifications throughout Construction Specifications	August 2023
05	Updates section 3.2.3.1 on road and laneway restoration requirements in Construction Specifications	August 2023
05	Updates to air entrainment requirements in Table 7.11.1: Fillcrete Requirements and Addition of Table 7.11.2: Pumpable Fillcrete Requirements	August 2023
05	Updates to Section 7.1.1.4 Quality Assurance	August 2023
05	Updates to Section 7.11.1.3 Quality Assurance	August 2023
05	Updates to Section 7 - Concrete to allow use of Portland Limestone Cement in Construction Specifications	August 2023
05	Updates width/depth ratio in section 6.9.3.3 of the Construction Specifications	August 2023
05	Table 2.1.1 and 2.1.3, changed application for Des 3 Class 63 from Granular Base to Granular Sub-base	August 2023
05	Update name from Engineering Services Section (ESS) to Technical Services Section (TSS) throughout Construction Specifications	August 2023
05	Adding standard drawings #3130, #3800, #3805, #3810, #3815, #3830, #3835, #3840, #3845, #3900, #5530, #5531, #6085, and #6525	August 2023
05	Updating standard drawings #2040, #2041	August 2023
04	Disclaimer and Authentication Table added	October 2021
04	Striking out of Sections 1.2.8 - 1.2.18 in 1. 'General' specification	October 2021
03	Adding 'Table of Offsets' note to Table 3.30 and Table 3.3.1	March 2021
03	Adding in temporary cross-section 2510	March 2021
02	Chapter 3 (Standard Drawings) Published	September 2018
01	Chapter 1 (Design Standards) and Chapter 2 (Construction Specifications) Published	June 2018

**Important Note:**

Printed or downloaded copies of this document are not controlled and may not be the current version.

Strike-outs through content in this document indicated information no longer applicable.

# TABLE OF CONTENTS

## CHAPTER 1: COMPLETE STREETS DESIGN

	<b>15</b>	<b>PURPOSE/INTENT OF THE DOCUMENT</b>
	<b>16</b>	<b>THE COMPLETE STREETS APPROACH</b>
	<b>17</b>	<b>HOW TO USE THE DOCUMENT</b>
<b>SECTION 1  </b>	<b>18</b>	<b>CONCEPTS AND PHILOSOPHY FOR COMPLETE STREETS DESIGN</b>
	19	1.1 DESIGN GOALS AND PRINCIPLES
	20	1.2 STREETS AS BOTH LINK AND PLACE
	22	1.3 DESIGNING WITH A SAFE SYSTEM LENS
	24	1.4 CONCEPT OF DESIGN DOMAIN
	26	1.5 DESIGNING WITH A UNIVERSAL LENS
	27	1.6 DESIGNING WITH A WINTER LENS
	28	1.7 DESIGNING WITH A RETROFIT LENS
	29	1.8 STREET TYPES AND MODAL PRIORITY
<b>SECTION 2  </b>	<b>37</b>	<b>DESIGN PROCESS, TRADE-OFFS AND EVALUATION</b>
	38	2.1 DESIGNING STREETS: DESIGN ZONES AND DESIGN PROCESS
	42	2.2 TRADE-OFFS AND DESIGN EXCEPTIONS PROCESS
	44	2.3 ANALYSIS PROCESS TO EVALUATE STREET DESIGN
<b>SECTION 3  </b>	<b>45</b>	<b>DESIGN REQUIREMENTS FOR COMPLETE STREETS DESIGN</b>
	46	3.1 GENERAL
	56	3.2 TRAVELLED WAY
	94	3.3 PUBLIC REALM
	113	3.4 ROADSIDE
	116	3.5 OFF-STREET PATHS/TRAILS
	119	3.6 INTERSECTIONS
	175	3.7 OFFSETS AND UTILITY ALIGNMENT
	179	3.8 TRAFFIC CALMING
	185	3.9 SHARED STREETS, REVERSE HOUSING LANES, AND ALLEYS
	190	3.10 TEMPORARY ROADS AND TURNAROUNDS
	191	3.11 VEHICULAR BARRIERS
	192	3.12 CUL-DE-SAC
	193	3.13 INDUSTRIAL STREETS
	195	3.14 WILDLIFE PASSAGES
<b>SECTION 4</b>	<b>196</b>	<b>REFERENCES</b>
<b>SECTION 5</b>	<b>197</b>	<b>ABBREVIATIONS</b>

# TABLE OF CONTENTS

## *Appendices*

- A | 199 COMPLETE STREET PRINCIPLES**
- B | 201 SAMPLE DESIGN EXCEPTION FORM**
- C | 202 SUMMARY OF GEOMETRIC DESIGN STANDARDS**
- D | 204 RIGHT TURN DESIGN MATRIX**
- E | 207 SIDEWALK, WALKWAY, AND PATHWAY REQUIREMENTS**
- F | 208 LIST OF DESIGN TABLES**

## CHAPTER 2: COMPLETE STREETS CONSTRUCTION SPECIFICATIONS

- 232 1.0 GENERAL**
- 232 1.1 CONSTRUCTION SPECIFICATIONS CONTENT
- 232 1.2 PAVEMENT DESIGN REQUIREMENTS
- 236 2.0 SITE PREPARATION**
- 236 2.1 AGGREGATES
- 241 2.2 CLEARING AND GRUBBING
- 243 2.3 GRADING
- 247 2.4 PAVEMENT AND CONCRETE REMOVAL
- 249 3.0 UTILITIES**
- 249 3.1 TRENCH BACKFILL
- 259 3.2 UTILITY CUT RESTORATION
- 264 4.0 BASE PREPARATION**
- 264 4.1 SUBGRADE PREPARATION
- 267 4.2 CEMENT STABILIZED SUBGRADE
- 271 4.3 PROOF ROLLING
- 273 4.4 PLANT MIX SOIL CEMENT
- 280 4.5 GEOTEXTILE
- 283 5.0 GRANULAR MATERIAL**
- 283 5.1 GRANULAR BASE COURSE
- 287 5.2 GRANULAR WALKWAY
- 289 5.3 FULL DEPTH RECLAIMED BASE COURSE



## TABLE OF CONTENTS

### 293 6.0 PAVEMENTS

293	6.1	SGC HOT-MIX ASPHALT CONCRETE
310	6.2	STONE MASTIC ASPHALT CONCRETE
320	6.3	SGC HOT-MIX ASPHALT PAVING
337	6.4	STONE MASTIC ASPHALT PAVING
350	6.5	PAVING BRICK ON SAND BED
353	6.6	PAVEMENT COLD MILLING
356	6.7	LIQUID ASPHALT COATS
360	6.8	FULL DEPTH RECLAMATION USING FOAMED ASPHALT
376	6.9	PAVEMENT CRACK SEALING
381	6.10	BRIDGE DECK ASPHALT SURFACING
394	6.11	RECYCLED ASPHALT PAVING

### 400 7.0 CONCRETE

400	7.1	CEMENT CONCRETE
408	7.2	CONCRETE SIDEWALK, CURB AND GUTTER, AND SLABS
415	7.3	CONCRETE FOR ROADWAYS
426	7.4	CONCRETE BASE
430	7.5	CONCRETE PAVEMENT
434	7.6	CONCRETE PAVING UNITS
437	7.7	ROLLER COMPACTED CONCRETE
448	7.8	PATTERNED CONCRETE SLAB
451	7.9	ULTRATHIN WHITETOPPING
460	7.10	CONCRETE FORMS AND ACCESSORIES
464	7.11	FILLCRETE
468	7.12	REINFORCING STEEL
471	7.13	SLABJACKING

### 474 8.0 MISCELLANEOUS

474	8.1	GABIONS
478	8.2	HEAVY ROCK RIP RAP
483	8.3	BOX BEAM GUARD RAIL
485	8.4	CONCRETE BARRIER

## TABLE OF CONTENTS

### CHAPTER 3: COMPLETE STREETS STANDARD DRAWINGS

#### SECTION 1000 | 497 UTILITY CUT RESTORATION

498	1000	PAVEMENT RESTORATION AFTER UTILITY CUT
499	1010	ROAD SURFACE RESTORATION AFTER UTILITY CUT
500	1020	TRANSVERSE CUT RESTORATION ARTERIAL ROAD
501	1021	TRANSVERSE CUT RESTORATION 14.5m COLLECTOR ROAD
502	1022	TRANSVERSE CUT RESTORATION 11.5m COLLECTOR ROAD
503	1023	TRANSVERSE CUT RESTORATION LOCAL INDUSTRIAL ROAD
504	1024	TRANSVERSE CUT RESTORATION LOCAL RESIDENTIAL ROAD
505	1025	TRANSVERSE CUT RESTORATION ALLEYS
506	1030	CURB AND GUTTER / MONOWALK REPLACEMENT SAWCUT DETAILS

#### SECTION 2000 | 507 CROSS-SECTIONS

508	2000	TYPICAL BERM SECTION
509	2020	STAGED ARTERIAL GRADING REQUIREMENTS
510	2030	RESIDENTIAL SERVICE ROAD
511	2031	INDUSTRIAL SERVICE ROAD
512	2040	4.00m RESIDENTIAL ALLEY
513	2041	6.00m COMMERCIAL ALLEY
514	2042	RESIDENTIAL REVERSE HOUSING ALLEY - 7.50m ROW
515	2043	REVERSE HOUSING ALLEY WITH PARKING - 9.50m ROW
516	2050	9.00m RURAL LOCAL / COLLECTOR ROADWAY
517	2060	TEMPORARY ACCESS / DETOUR ROAD
518	2120	8.00m URBAN LOCAL RESIDENTIAL (MONOWALK BOTH SIDES) - 16.00m ROW
519	2125	8.00m STREET ORIENTED RESIDENTIAL LOCAL (ON BIKE NETWORK / NOT ON BIKE NETWORK) - 16.00m ROW
520	2200	9.00m URBAN LOCAL RESIDENTIAL (MONOWALK) - 17.00m ROW
521	2210	9.00m STREET ORIENTED RESIDENTIAL LOCAL (ON BIKE NETWORK / NOT ON BIKE NETWORK) - 17.00m ROW
522	2300	11.50m INDUSTRIAL LOCAL (MONOWALK) - 20.00m ROW
523	2310	11.50m INDUSTRIAL LOCAL (BOULEVARD WALK) - 20.00 ROW
524	2320	11.50m STREET ORIENTED RESIDENTIAL COLLECTOR (NOT ON BIKE NETWORK) - 20.00m ROW
525	2321	9.30m COLLECTOR (NOT ON BIKE NETWORK) - 18.00m ROW
526	2322	10.70m NON-STREET ORIENTED RESIDENTIAL COLLECTOR (ON BIKE NETWORK) - 19.00m ROW
527	2323	11.30m NON-STREET ORIENTED RESIDENTIAL OR COMMERCIAL/MIXED USE COLLECTOR (ON BIKE NETWORK) - 19.60m ROW
528	2324	13.75m STREET ORIENTED RESIDENTIAL COLLECTOR (ON BIKE NETWORK) - 22.0m ROW

## TABLE OF CONTENTS

529	2325	9.30m NON-STREET ORIENTED RESIDENTIAL OR COMMERCIAL / MIXED USE COLLECTOR (ON BIKE NETWORK) - 22.0m ROW
530	2326	12.00m STREET ORIENTED COMMERCIAL/MIXED USE COLLECTOR (NOT ON BIKE NETWORK) - 22.00m ROW
531	2327	11.50m STREET ORIENTED RESIDENTIAL COLLECTOR (ON BIKE NETWORK) - 22.0m ROW
532	2328	11.50m SCHOOL SITE COLLECTOR (NOT ON BIKE NETWORK) - 20.0m ROW
533	2341	16.30m STREET ORIENTED RESIDENTIAL COLLECTOR (ON BIKE NETWORK) - 24.00m ROW
534	2342	16.80m STREET ORIENTED COMMERCIAL MIXED-USE COLLECTOR (ON BIKE NETWORK) - 26.60m ROW
535	2410	13.70m URBAN COLLECTOR (BOULEVARD WALK) - 23.80m ROW
536	2411	13.20m INDUSTRIAL COLLECTOR (SHARED USE PATH) - 24.00m ROW
537	2420	11.10m HYBRID INDUSTRIAL COLLECTOR (BOULEVARD WALK) - 30.55m ROW
538	2421	9.50m HYBRID INDUSTRIAL LOCAL (BOULEVARD WALK) - 27.50m ROW
539	2430	9.00m RURAL INDUSTRIAL COLLECTOR - 42.90m ROW
540	2431	9.00m RURAL INDUSTRIAL LOCAL - 38.60m ROW
541	2500	5 LANE INDUSTRIAL URBAN UNDIVIDED ARTERIAL - 37.00m ROW
542	2510	FOUR LANE NON-STREET ORIENTED RESIDENTIAL DIVIDED ARTERIAL - 37.00m ROW - B
543	2510A	FOUR LANE NON-STREET ORIENTED RESIDENTIAL DIVIDED ARTERIAL - 37.00m ROW - B
544	2515	FOUR LANE STREET ORIENTED RESIDENTIAL DIVIDED ARTERIAL - 40.00m ROW
545	2520	6 LANE URBAN DIVIDED ARTERIAL - 44.00m ROW
546	2530	RURAL FIVE LANE INDUSTRIAL ARTERIAL (SHARED USE PATH) - 57.40m ROW
547	2600	UTILITIES LOCATION PLAN WALKWAYS
548	2720	SLOPE REGULATION RESIDENTIAL PRIVATE DRIVEWAY/PARKADE RAMP MONOWALK
549	2730	SLOPE REGULATIONS RESIDENTIAL PRIVATE DRIVEWAY/PARKADE RAMP BOULEVARD WALK

### SECTION 3000 | 550 DESIGN DETAILS

551	3000	INDUSTRIAL SERVICE ROAD "BULB" ENTRANCE
552	3010	MAJOR COMMERCIAL ACCESS TYPICAL CURB RETURN FORMAT
553	3020	RURAL LOCAL ACCESS
554	3030	ALLEY WIDENING IN LIEU OF 3.00m x 3.00m CORNER CUT-OFF
555	3040	PUBLIC ALLEY CUL-DE-SAC AND CORNER CUTS
556	3100	RIGHT TURN STANDARD ARTERIAL TO ARTERIAL CHANNELIZED HIGH ENTRY ANGLE (YIELD CONDITION)
557	3110	RIGHT TURN STANDARD ARTERIAL TO ARTERIAL CHANNELIZED LOW EXIT ANGLE (FREE FLOW)
558	3120	RIGHT TURN STANDARD ARTERIAL TO ARTERIAL UNCHANNELIZED SIMPLE CURVE (STOP CONDITION)
559	3130	RIGHT TURN WITH MOUNTABLE CURB
560	3200	RIGHT TURN BAY STANDARD ARTERIAL TO COLLECTOR
561	3210	RIGHT TURN BAY STANDARD ARTERIAL TO ARTERIAL
562	3300	LEFT TURN BAY STANDARD NARROW MEDIAN
563	3310	LEFT TURN BAY STANDARD WIDE MEDIAN
564	3320	LEFT TURN STANDARD CHANNELIZED SLOT
565	3350	RIGHT AND LEFT TURN BAY STANDARD CURVED MAIN LINE

## TABLE OF CONTENTS

566	3400	ISLAND LAYOUT FOR INTRODUCTION OF CHANNELIZATION
567	3500	RESIDENTIAL CUL-DE-SAC (WITHOUT ISLAND)
568	3510	RESIDENTIAL CUL-DE-SAC (CIRCULAR ISLAND)
569	3520	RESIDENTIAL CUL-DE-SAC (CIRCULAR OFFSET ISLAND)
570	3530	RESIDENTIAL CUL-DE-SAC (CIRCULAR ISLAND)
571	3540	SIDEWALK REQUIREMENTS CUL-DE-SAC
572	3700	NEIGHBORHOOD TRAFFIC CIRCLE 9m URBAN LOCAL x 9m URBAN LOCAL
573	3710	MINI ROUNDABOUT 11.5m URBAN COLLECTOR x 11.5m URBAN COLLECTOR WITH SHARED-USE PATH AND ON-STREET BIKE LANE
574	3720	MULTILANE ROUNDABOUT 13.9m URBAN COLLECTOR x 13.9m URBAN COLLECTOR
575	3800	RAISED INTERSECTION CROSSING - ASPHALT
576	3805	RAISED INTERSECTION CROSSING - CONCRETE
577	3810	CONCRETE DETAILS - RAISED CROSSING
578	3815	CONCRETE DETAILS - RAISED INTERSECTION
579	3830	RAISED MID BLOCK CROSSING - ASPHALT
580	3835	RAISED MID BLOCK CROSSING - CONCRETE
581	3840	CONTINUOUS CROSSING
582	3845	CONTINUOUS CROSSING ISOMETRIC DETAIL
583	3900	BOULEVARD SIDEWALK TRANSITION AT TRANSFORMER

### SECTION 4000 | 584 TRANSIT DETAILS

585	4000	LOCATION OF BUS STOP (UNCHANNELIZED INTERSECTION)
586	4010	LOCATION OF BUS STOP (CHANNELIZED INTERSECTION)
587	4100	BUS STOP AND AMENITIES PAD MONOWALK
588	4110	BUS STOP AND AMENITIES PAD BOULEVARD WALK
589	4200	BUS STOP AND AMENITIES PAD RURAL ROADWAY
590	4250	CLASS 'A' CONCRETE BUS STOP PAD (RETROFIT)
591	4300	TRANSIT TURNAROUND (OFFSET)
592	4400	SAWTOOTH TRANSIT BAY TRANSIT TERMINAL SITE

### SECTION 5000 | 593 CONSTRUCTION DETAILS

594	5000	150mm CURB WITH 250mm GUTTER
595	5001	150mm CURB WITH REVERSE 250mm GUTTER
596	5010	150mm CURB AND 250mm GUTTER WITH MONO CONCRETE HEADER
597	5011	150mm CURB AND 250mm REVERSE GUTTER WITH MONO CONCRETE HEADER
598	5020	STRAIGHT FACE CONCRETE CURBLINE WALK/BUS STOP (RETROFIT)
599	5021	ROLLED FACE CURBLINE WALK (RETROFIT)
600	5022	150mm CURB AND 500mm GUTTER (RETROFIT)
601	5023	125mm SEMI-MOUNTABLE CURB AND 250mm GUTTER

## TABLE OF CONTENTS

602	5024	80mm ROLLED MOUNTABLE FACE CURB AND 250mm GUTTER
603	5030	500mm/1000mm CONCRETE V-GUTTERS
604	5040	CONCRETE BARRIER CURB
605	5051	TEMPORARY SLAB-ON CONCRETE CURB
606	5052	TEMPORARY SLAB-ON ASPHALT CURB
607	5060	DEPRESSED CURB AND GUTTER FOR CATCHBASIN
608	5061	CATCHBASIN TREATMENT 50mm OVERLAY OF GUTTER
609	5070	LAWN MOWER ACCESS TO MEDIAN
610	5100	MONOLITHIC WALK WITH 150mm CURB AND 250mm GUTTER
611	5110	MONOLITHIC WALK WITH 150mm CURB AND 500mm GUTTER (RETROFIT)
612	5120	ROLLED FACE MONOLITHIC WALK AND GUTTER
613	5130	EMERGENCY ACCESS ROAD CONCRETE
614	5140	CONCRETE WALKWAY - 1.80m
615	5150	CONCRETE WALKWAY - GREATER THAN 1.80m
616	5160	SHARED USE PATH
617	5165	TOP OF BANK TRAIL
618	5170	GRANULAR WALKWAY
619	5180	SIDEWALK CONSTRUCTION AT TREE OPENING
620	5200	WOODEN WALK
621	5201	WOODEN STAIRS AND SUPPORT STRUCTURE
622	5205	WOODEN NOISE ATTENUATION FENCE
623	5210	PAVING BRICK SIDEWALK CONSTRUCTION
624	5215	PAVING BRICK CROSSWALK CONSTRUCTION
625	5300	ALLEY CROSSING BOULEVARD WALK AND APRONS
626	5310	ALLEY CROSSING MONOWALK AND APRONS
627	5320	PRIVATE CROSSING SEPARATE WALK AND APRONS
628	5330	PRIVATE CROSSING MONOWALK AND APRONS
630	5340	PRIVATE CROSSING MONOWALK (RETROFIT)
631	5400	COMMERCIAL CROSSING BOULEVARD WALK AND APRONS (BOULEVARD > 1.50m)
632	5410	COMMERCIAL CROSSING MONOWALK AND BOULEVARD WALK (BOULEVARD < 1.50m)
633	5500	CURB RAMP LOCATIONS
634	5510	CURB RAMP
642	5520	TACTILE WALKING SURFACE INDICATOR (TWSI) LAYOUT FOR SEPARATE WALK
635	5521	TACTILE WARNING SURFACE INDICATOR (TWSI) LAYOUT FOR WALK
636	5522	TACTILE WALKING SURFACE INDICATOR (TWSI) LAYOUT FOR MID-BLOCK CROSSING
637	5523	TACTILE WALKING SURFACE INDICATOR (TWSI) ORIENTATION FOR OFFSET INTERSECTIONS
638	5524	TACTILE WALKING SURFACE INDICATOR (TWSI) MEDIAN DETAIL
639	5530	TYPE A RAMP TWSI OPTION 1

## TABLE OF CONTENTS

640	5531	TYPE A RAMP TWSI OPTION 2
641	5600	MID-BLOCK BIKEWAY SLIP RAMP
642	5610	CENTRE MEDIAN END TREATMENT
643	5620	WIDE MEDIAN END TREATMENT
644	5630	CENTER MEDIAN REHABILITATION
645	5700	MULTI-PARTY UTILITIES TRENCHING

### SECTION 6000 / 7000 | 646 MISCELLANEOUS

647	6010	SLIPFORMED CONCRETE BARRIER 5.50m MEDIAN
648	6020	CONCRETE BARRIER ON PAVED MEDIAN
649	6030	END TRANSITION CONCRETE BARRIER
650	6050	LIFT OUT FOR CONCRETE BARRIER
651	6060	830mm CONCRETE SLIP-FORMED PARAPET WITH 1.00m SWALE
652	6085	HANDRAIL DETAILS
653	6090	STANDARD TAPER AT BRIDGE PIERS CONCRETE BARRIER
654	6100	PRE-CAST CONCRETE MINI-BARRIER
655	6101	END TRANSITION PRE-CAST CONCRETE MINI-BARRIER
656	6200	TYPICAL BOLLARD LAYOUT AND INSTALLATION FOR 1.80m CONCRETE WALKWAYS
657	6210	TYPICAL BOLLARD LAYOUT AND INSTALLATION FOR 3.00m SHARED-USE PATH
658	6220	TYPICAL BOLLARD WITH GALVANIZED STEEL W-SECTION
659	6230	TYPICAL BOLLARD LAYOUT FOR 3.00m ASPHALT SHARED-USE PATH WITHIN PIPELINE/POWER ROW
660	6240	EMERGENCY KNOCK-DOWN POST (RETROFIT)
661	6250	T-BOLLARD IN EMERGENCY ACCESS
662	6251	T-BOLLARD ASSEMBLY DETAIL
663	6300	ASPHALT SPEED HUMP
664	6500	COST SHARE PROJECT SIGN
665	6510	AUXILIARY PROJECT SIGN
666	6520	ARTERIAL ROAD PROJECT SIGN DEVELOPER-BUILT PROJECTS
667	6525	BRIDGE/CULVERT STANDARD IDENTIFICATION PLAQUES AND BENCHMARK TABLETS
668	6530	TYPICAL A-FRAME SIGN
669	6600	MANHOLE INSTALLATION FOR SURVEY CONTROL MARKERS DEPTHS BETWEEN 0.20m - 0.60m
670	7976	CATCH BASINS IN WALKWAY RIGHT-OF-WAY
671	7980	BACKFILL DETAIL OF MANHOLE AND VALVE RAISED TO GRADE
672	7981	BACKFILL DETAIL OF MANHOLE AND VALVE RAISED TO GRADE (FILLCRETE OPTION)

## PURPOSE/INTENT OF THE DOCUMENT

The Complete Streets Design and Construction Standards (CSDCS) document provides a single point of reference that supports the planning, design, and construction of Complete Streets in Edmonton. It integrates the best practices in Complete Streets design philosophy and guidance introduced in the City's 2013 Complete Streets Guidelines with the City of Edmonton's former Roadway Design Standards and Construction Specifications.

The intent of these Complete Streets Design & Construction Standards is to encourage a holistic approach to street design that will develop a network of streets that is safe, attractive, comfortable, and welcoming to all users in all seasons, while considering operational and maintenance challenges. The document introduces the 'Design Domain' approach which allows flexibility in design through variance in street element design values based on the modal priorities and context of a specific corridor.

From a technical perspective, the document is intended primarily for engineers, planners, and the development industry. Though the document can be utilized by communities and the public, a less technical primer a companion document will better serve those users.

The Complete Streets Design and Construction Standards are intended to be a living document, with regular updates to incorporate changes in best practice and their application in the Edmonton context.

## THE COMPLETE STREETS APPROACH

Historically in Edmonton, transportation systems have been designed based on roadway functional classification with the primary focus on accommodating motor vehicle connections to destinations. Roadways designed in this fashion typically function as a link that primarily moves people in vehicles from Point A to Point B and are typically referred to as 'roads'.

When other modes of transportation, such as walking and cycling are considered, there are competing demands for limited space and several challenges arise when designing a 'street':

- + How can the often-competing demands of people walking, riding bikes, taking transit, delivering goods, driving, and being driven be accommodated?
- + How can the design reflect the varying land uses along a corridor today and in the future?
- + How can cost-effective innovations, such as sustainable stormwater practices and improved urban design, be incorporated?
- + How can the design accommodate essential infrastructure such as hydrants and street lights?
- + How are placemaking elements provided and how might they vary to reflect unique community needs along a corridor?

Complete Streets attempts to address these challenges and represents a change from the past vehicle-focused roadway design philosophy.

The Complete Streets Design and Construction Standards provide context sensitive direction for the planning, design, and construction of streets for users of all modes. Over time, use of these standards will result in the creation of a transportation network that will accommodate the needs of all modes of travel in a safe, context sensitive manner. To accomplish this, some streets will prioritize certain modes over others. For example, a complete street in a shopping district may place priority on a person walking, cycling, and riding public transit, while a freeway will provide for high quality motor vehicle commuter traffic and goods movements. So, while each street in a network may not be designed to accommodate or prioritize every mode of transportation, the network of streets and off-street pathways will accommodate movements for users of all modes.



## HOW TO USE THE DOCUMENT

*These Complete Streets Design and Construction Standards are comprised of three chapters as follows:*

### **Chapter 1: Complete Streets Design Standards**

contains higher level Complete Streets design philosophy and guidance. This Chapter draws upon existing content from Edmonton's original Complete Streets Guidelines, Main Streets Guideline, and previous Design Standards and Constructions Specifications, as well as the Transportation Association of Canada's (TAC) Geometric Design Guide for Canadian Roads (GDG) 2017. Chapter 1 is further broken down into three sections:

- + Section 1.0: Concepts and Philosophy for Complete Streets Design.
- + Section 2.0: Design Process, Trade-offs and Evaluation.
- + Section 3.0: Design Requirements for Complete Streets Design.
  - + Using Sections 1.0, 2.0, and 3.0, designers can produce context sensitive, functional, and sustainable street designs based on the design requirements for the street type based on its associated users. Where a street is identified as a Main Street, it should follow the guidance in the Main Streets Guidelines wherever practical.

**Chapter 2: Construction Specifications** contains detailed specifications that have been updated to align with best practices in construction methodology.

**Chapter 3: Standard Drawings** contains standard drawings that can be used in the design of streets in Edmonton including street cross sections, intersection elements, and other geometric design details.

## SECTION 1.0: CONCEPTS AND PHILOSOPHY FOR COMPLETE STREETS DESIGN

### 1.0

Streets contribute to the quality of life in our city by providing choice in how people get around and providing essential public space for us to connect with one another. Streets are used by many different people in many ways and for many different reasons. Truck drivers use them to deliver goods, seniors to walk and get exercise, children to get to school and meet friends, families to drive for errands, workers to walk or ride their bicycles to work, and transit drivers to get their passengers where they need to go. In addition to connecting people to places, streets create public spaces for people to stop, linger, and enjoy the city. Streets also house essential infrastructure such as storm and sanitary sewers, water lines, gas service lines, and street lights.



## DESIGN GOALS AND PRINCIPLES

### 1.1

The City of Edmonton (City) recognizes that a network of streets serving multiple modes has the potential to increase the overall capacity and efficiency of the transportation network and facilitate a shift from a primarily motor vehicle-focused system towards one that offers a wider range of viable transportation choices. *The goal of the Complete Streets Design and Construction Standards (CSDCS) is to create a network of streets that are safe, welcoming, attractive, comfortable, and functional for all users in all seasons, and that support and enhance the unique characteristics of the neighborhoods and districts they serve.*

A set of Principles have been developed to plan, design, and operate streets in Edmonton to help shape the goals and objectives of any street design project and aid in the evaluation of possible designs. The Design Principles are as follows:

- + A network of streets, transitways, and off-street pathways that together accommodate all users and allow for efficient and high quality travel experiences;
- + The transportation network provides travel options for users of all ages and abilities that are safe, universally designed, context sensitive, and operable in all seasons (including winter);

- + Streets are adaptable by accommodating the needs of the present and future;
- + Streets contribute to the environmental sustainability and resiliency of the city;
- + Consider both direct and indirect costs, as well as the value of the public right of way and the adjacent real estate; and
- + Streets are vibrant and attractive people places in all seasons to contribute to an improved quality of life.

Details on how implementation of these principles improves the completeness of streets is discussed in Appendix A.

## STREETS AS BOTH LINK AND PLACE

### 1.2

Streets are a valuable public amenity, and take up significant space in Edmonton. When we limit the use of streets to vehicular traffic and only as a link between points, other users are inevitably excluded from this public asset. Streets can function not just as a link between places, but as a social space with an important relationship with the places where people live, work, and play. They can be designed to enable commercial activities and social interaction, and form an integral part of the ecosystem that supports environmental and ecological sustainability and biodiversity. They can also have distinct aesthetics and a range of users, which attracts more users and creates a street character that transforms the street into a Place and a destination in its own right.

When one utilizes streets as both Links to get us around, and Places where we can spend time, this public space becomes more valuable to a city's residents and businesses. To reflect this value, the design philosophy adopted by the City of Edmonton is to use both Link and Place concepts in designing streets.

# STREETS AS BOTH LINK AND PLACE

## 1.2

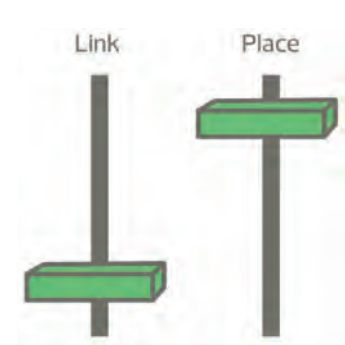
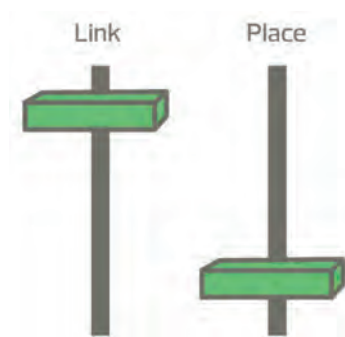
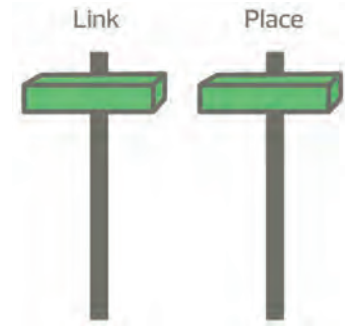

Figure 1.1 Link & Place Concept

## DESIGNING WITH A SAFE SYSTEM LENS

### 1.3

In general, the City of Edmonton has always strived to consider the safety of all users as the highest priority in the street design process. However, ongoing changes to Edmonton's transportation system, including increased mode shift to public transportation and demand for multimodal options, has in recent years required a more holistic approach to designing and operating an increasingly complex transportation system. Furthermore, to increase safety, greater emphasis must be placed on a proactive and strategic process in the design and operation of Edmonton streets. To this end the City has adopted Vision Zero and the Safe Systems Approach.

In 2015, the City was the first Canadian city to officially adopt Vision Zero, a global initiative to eliminate fatalities and serious injuries from traffic collisions. A key component of this initiative is the adoption of the Safe Systems Approach. Central to this approach is a shared accountability between street users and those who design, maintain, and operate all parts of the transportation system.

The Safe Systems Approach views the transportation system holistically by addressing the interaction between the system users, the street and public realm/roadside, speed, and vehicles. The approach acknowledges that even responsible people sometimes make mistakes when traveling. This is a change from traditional approaches that tended to blame the user for causing a collision. Given that mistakes are inevitable, the approach recognizes the need to protect people from death or serious injury

There is no such thing as "absolute safety", despite efforts to maintain, improve, and operate transportation facilities to the highest level that funding allows. There is risk in all transportation, regardless of the mode or combination of modes considered. That risk is inherent due to the variability of user behaviors, environmental conditions, and other factors over which no one has absolute control. Accordingly, the City recognizes that the transportation system should be designed such that "when collisions do happen, deaths can be avoided and injuries minimized."

The design approach adopted in Edmonton to address this inherent risk focuses on minimizing conflicts in time or space and minimizing the speed differential where conflicts remain. In doing so, the probability of death or serious injury, particularly for people walking, wheeling, and cycling, will be significantly reduced. This concept is illustrated in Figure 1.2, which shows that below 50 km/h, the chance of a person walking surviving a collision rises significantly.

## DESIGNING WITH A SAFE SYSTEM LENS (CONT.)

### 1.3

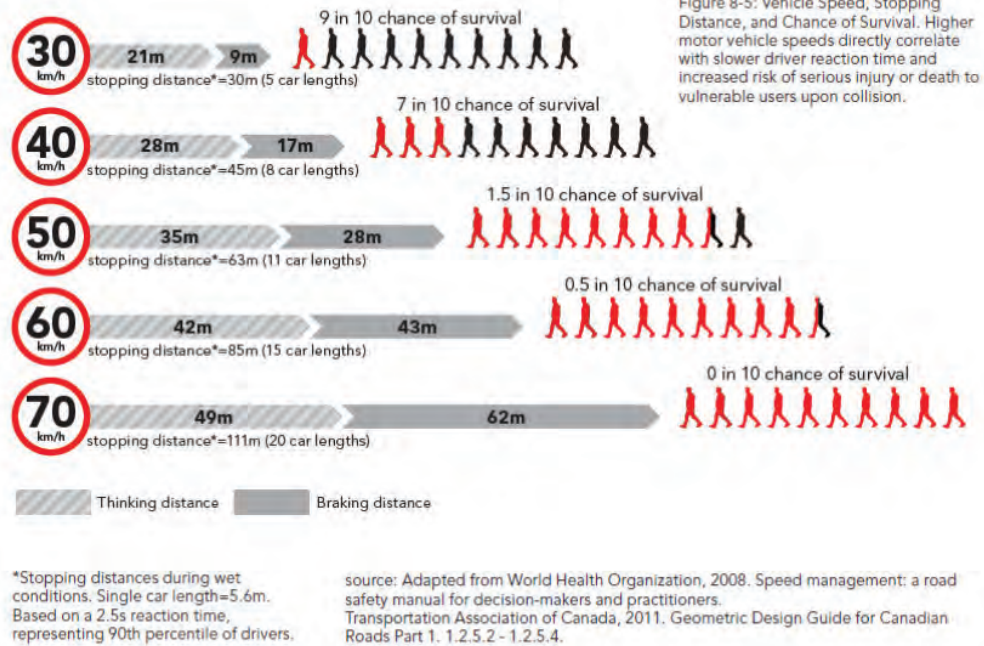

**Figure 1.2** Vehicle Speed, Stopping Distances, and Chance of Survival (Adapted from Figure 8.5, World Health Organization, 2008, Speed Management: a road and safety manual for decision-makers and practitioners)

Creating a Safe System that achieves Vision Zero requires one to:

- + Make the transportation system more accommodating of human error;
- + Manage the forces that injure people in a collision to the level a human body can tolerate without serious injury; and,
- + Minimize the level of unsafe user behaviour.

The CSDCS support the Safe Systems Approach and Vision Zero by providing design guidance that aligns with current best practice in designing streets for users of all ages and modes. This design guidance is adapted from the TAC GDG to reflect the needs of Edmonton’s

urban streets. The guidance is intended to result in streets that are self-explanatory and produce street user behaviour that is appropriate for the design/posted speed and human-scaled interactions. Two examples of the type of adaptation that has been made is in design speed and lateral clearance (clear zone) from obstructions. The CSDCS require design speed to equal posted speed for streets with posted speeds of 50 km/h or less. The CSDCS also require offsets to poles and trees that are much lower than in high speed environments (posted speed over 60km/h) to reduce the width/scale of the street and encourage slower motor vehicle speeds while ensuring adequate sight lines are maintained at intersections, accesses, and mid-block crossings.

# CONCEPT OF DESIGN DOMAIN

## 1.4

### 1.4.1 What is Design Domain?

The Design Domain concept was first introduced in the 1999 edition of the TAC GDG. While the concept is discussed in the following section, more information can be found in Chapter 1, Design Philosophy of the 2017 TAC GDG.

Design Domain can be thought of as a range of values that a design element, such as sidewalk width, lane width, design speed, or road curvature, might take. This range has a relationship with the fitness-for-purpose of the design element, as shown in Figure 1.3. For example, utilizing values in the lower regions of the domain for a single design element may result in designs which may be less efficient or less safe although perhaps less costly to construct. Utilizing values in the upper regions of the domain may result in designs which may be considered to be safer in some aspects and more efficient in operation, but may cost more and may be less safe in other aspects. While all values within the range of Design Domain

are acceptable, some may be better than others for a given situation. In all cases, care must be taken when selecting multiple lower bound values for elements along a corridor to ensure there are no compounding negative impacts.

The Design Domain concept provides several benefits to the designer including:

It is more directly related to the true nature of the street design function and process, since it places a greater emphasis on developing appropriate and cost effective designs rather than those that simply meet guidelines or targets; and

It directly reflects the continuous nature of the relationship between service, cost, and safety with changes in the values of design dimensions. It reinforces the need to consider the impacts of trade-offs throughout the Domain and not just when the threshold is crossed.

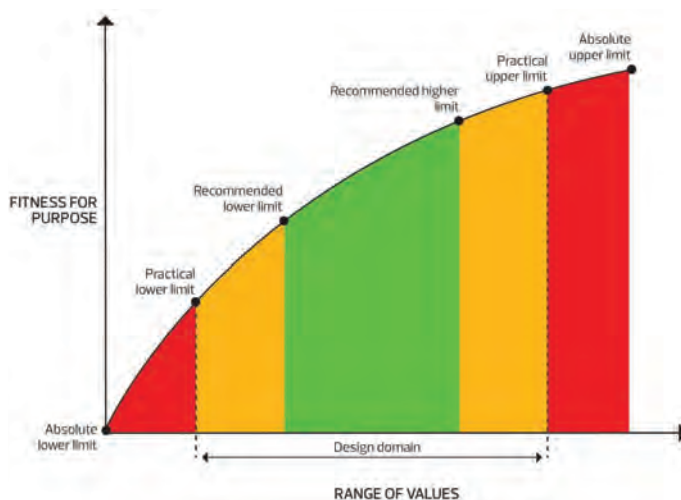

Figure 1.3 The Design Domain Concept<sup>1</sup>

<sup>1</sup> TAC GDG Figure 1.4.1.s. 2017.



## CONCEPT OF DESIGN DOMAIN (CONT.)

### 1.4

Wherever possible, data or information that provides estimates of changes in the quality of mobility, cost, or safety resulting from changes in the design, should be used to evaluate the impact of design decisions. Aesthetics, sustainability, and alignment with planning documents and land use context should also be considered. In keeping with Edmonton's multimodal approach to transportation, such evaluations should be carried out for all modes that the facility is designed to accommodate including walking, cycling, public transit, and motorized vehicles for personal mobility and goods movement. Where no such data or information is available, guidance is provided to the designer on the safety impacts of changes to criteria in the CSDCS as well as the TAC GDG.

#### 1.4.2 Applying the Design Domain Concept

Applying the concept of Design Domain in practice may present challenges. While Design Domain is often presented as a continuous range of values bounded by an upper and lower limit, in some cases, it may only be relevant to consider a series of discrete values for the dimension in question. Lane widths, which typically are varied in increments of 0.1 m, provide a good example of such a case. In other instances, there may be no upper limit to a Design Domain other than practicality or economics (e.g. land costs for right of way). In these cases, the upper boundary of the Design Domain generally reflects typical upper level values found in practice, or the general threshold of cost-effective Design.

The designer must respect controls and constraints to a greater or lesser degree depending on their nature and significance. Some design requirements are inflexible, such as vertical clearance at structures, while others are less rigid. Often, the designer is faced with the dilemma of being unable to choose design

dimensions that will satisfy all controls and constraints, with a trade-off being required. These are engineering decisions that call for experience, insight, and a good appreciation of community values.

Design requirements can be directed based on safety, service, capacity, comfort, and even aesthetic values. The designer must have a good understanding of their origin and purpose, and apply them with regard for community priorities. If a range of dimensions is given, the designer must select the appropriate value. In some cases, it may be necessary for the designer to choose values that fall outside the specified boundaries of the Design Domain for a given design element. Such cases are extraordinary and can have substantial impacts on various aspects of facility performance, including the safety of street users. Only in exceptional circumstances, where appropriate justification is provided, shall a variance below the minimum or above the maximum standard be accepted by the City. The Design Exception Process described in Section 2.2 outlines how a variance can be obtained.

The consequences of reducing a value for a design requirement should be understood, particularly regarding safety performance and impacts, but also in terms of other costs and benefits. Mitigating measures, which could include a broad range of potential actions, need to be considered along with the geometric design. If a design involves trade-offs, it may be more appropriate to adjust several elements a small amount than to compromise one element excessively.

The Design Domain for Edmonton is based on the Recommended Range from the TAC GDG with adjustments made for local context.

# DESIGNING WITH A UNIVERSAL LENS

## 1.5

Universal Design is an approach to design that increases the potential for developing a better quality of life for a wider range of individuals. The design process creates an environment that is usable to as many people as possible regardless of age, ability, or situation as summarized in *Figure 1.4*.

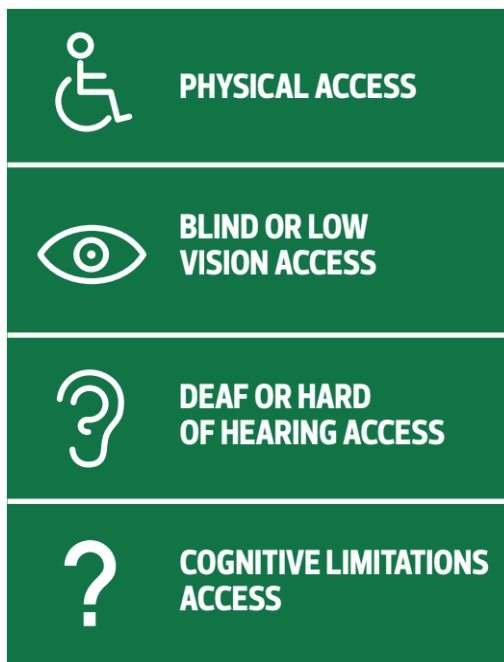

*Figure 1.4* Designing for All Users (Source: City of Edmonton Checklist for Accessibility and Universal Design in Architecture)

Social inclusion underscores Universal Design, which addresses the barriers faced by people with disabilities, older people, children, and other populations that in the past may have been overlooked in the design process. In so doing, streets are designed for the movement of all people at various stages of life and regardless of ability.

*Figure 1.5* summarizes the principles of Universal Design the designer should typically consider to support the broadest set of design users applicable to the context. For the purposes of this document, we *define people walking* to include the following:

- + people running;
- + people standing;
- + people using manual/motorized wheelchairs or scooters;
- + people using canes or walkers;
- + people pushing strollers or carts;
- + people pushing bicycles; and
- + users of various other low-speed forms of human locomotion (e.g., skateboards).

Accordingly, wherever CSDCS refers to people walking or people walking and wheeling, it includes the aforementioned modes of travel.

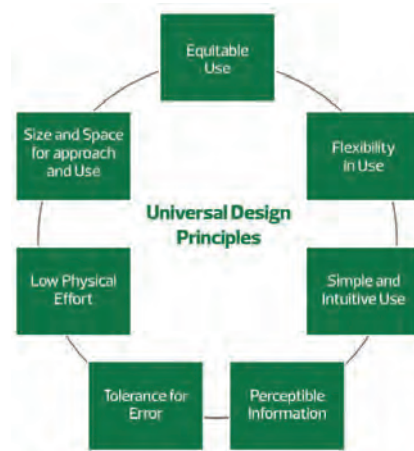

*Figure 1.5* Universal Design Principles (Source: Adapted from Center for Universal Design, 1997)

## DESIGNING WITH A WINTER LENS

### 1.6

Edmonton is a northern, winter city and the impact of winter needs to be considered in the design process. Experience shows that when a street is designed with winter in mind, it will be comfortable in all seasons.

Designing with a winter lens is not only designing from a winter perspective, but including this perspective at the beginning of the design process.

As outlined in the City of Edmonton’s Winter Design Guidelines (WDG), there are five main principles that apply to designing for winter:

- + Design and provide infrastructure that supports desired winter life and improves comfort in cold weather;
- + Create visual interest with light;
- + Incorporate design strategies to block wind;
- + Maximize exposure to sunshine; and
- + Use colour to enliven the winterscape.

A typical winter city cross section is illustrated in *Figure 1.6*.

Winter city design also means designing facilities with consideration to the maintenance and operations that occur due to the impacts of snow accumulation and snow clearing. For street design, the WDG impacts decisions around the design of:

- + Sidewalks and Boulevards (Section 2.2.1 WDG);
- + Street Crossings (Section 2.2.2 WDG);
- + Bus Stops (Section 2.2.7 WDG); and
- + Bicycle Routes and Storage (Section 2.2.9 WDG).

Other recommendations include guidance on street lighting, street furnishings, public art, wayfinding, light rail stops, bridges, and parking considerations.



*Figure 1.6 A Typical Winter City Streetscape (Source: City of Edmonton Winter Design Guidelines)*

## DESIGNING WITH A RETROFIT LENS

### 1.7

The design of retrofit street infrastructure poses many challenges which are not encountered in growth or greenfield projects. In retrofit situations especially, designs must consider the location of existing buildings, mature trees, utility infrastructure, private landscaping within public right of way, and numerous other constraints, within an existing right of way. These constraints must be addressed while striving to balance the needs of all street users and incorporating input through public engagement. Strategic compromises and trade-offs through use of the Design Domain concept may need to be made by the designer to balance costs, technical feasibility, and other constraints.

There may be instances in retrofit situations where it is not feasible or possible to completely align with the requirements of these standards. In these instances, the designer should clearly identify where there is variation from the standards, and document the rationale for the deviation in a Design Exception. Documentation of the variation can be done at a neighbourhood level if the same variance is required throughout. For example, if lane or sidewalk widths must be varied due to tree and right of way conflicts on more than one street, the design exception can identify the area or range of streets to which the rationale applies for those with the same conditions and context.

# STREET TYPES AND MODAL PRIORITY

## 1.8

### 1.8.1 Street Types

Street type is defined by the:

- + Relationship of buildings to the street;
- + Land use context; and
- + Functional classification of the street.

The result is a three-dimensional matrix of potential street types (e.g., a street oriented residential collector), which should be further evaluated with how the adjacent land uses and buildings may change over time. The following sections summarize the factors that contribute to defining street type.

#### *Relationship of the Building to the Street:*



#### **Street Oriented:**

Characterized by buildings that are built to minimum setbacks with building entrances directly on the street, prioritizing walking and wheeling activity over driving activity. Vehicular access is typically from side streets or alleys to create an uninterrupted pedestrian through zone.



#### **Non-Street Oriented:**

Characterized by greater building setbacks from the street and building entrances that face areas internal to their sites (most often surface parking lots).

## STREET TYPES AND MODAL PRIORITY (CONT.)

### 1.8

#### Land Use Context:



#### Residential:

Areas whose predominant character is defined as places where people live.



#### Community Destinations & Open Spaces:

Areas that are major activity generators that are visited by residents on a regular basis, like high schools, district parks, recreation centres, hospitals, universities and colleges, and other major public and institutional uses that drive their own distinct transportation behaviour.



#### Commercial/Mixed Use:

Areas with commercial and retail uses and places of employment ranging from main street-style retail areas, downtown office towers, and shopping malls. Mixed use is achieved by co-locating these commercial and employment uses with residential, creating transportation behaviour that is different from exclusively residential areas. Main Streets are a specific type of commercial mixed use street with more details provided in the Edmonton Main Streets Guideline.



#### Industrial:

Areas with employment and typified by warehouses, manufacturing establishments, and large industrial plants and may include commercial functions. Transportation behaviour is unique from other employment areas due to truck access requirements and lack of residential uses..

## STREET TYPES AND MODAL PRIORITY (CONT.)

### 1.8

#### *Functional Classification:*

**Freeway:** defined in the Transportation System Bylaw, these streets are high traffic volume and speed roads with limited access and typically grade separated Intersections.

**Arterial:** defined in the Transportation System Bylaw, these streets carry larger volumes of traffic (people driving as well as those riding transit, walking and wheeling, cycling, and delivering goods) between areas with relatively few and controlled access points.

**Collector:** provide neighbourhood travel between local and arterial streets with direct access to adjacent land. Public transit buses generally operate on collector streets within neighbourhoods.

**Local:** provide direct access to adjacent lands and serve neighbourhood travel and include service roads.

**Alley:** provide direct access to adjacent lands typically parallel to other classification of streets and are typically used for access, deliveries, and waste collection. In core urban areas, some alleys are evolving into shared streets, with alley oriented development

**Shared Street:** these streets significantly limit motor vehicle traffic, and limit drivers to speeds that are no faster than a person can walk. Design elements like pavement material and entry features define the space and make it clear that shared streets are primarily designed for people walking, wheeling, and cycling.

**Pedestrian Only Street:** Unlike shared streets that allow people walking, wheeling, cycling, and driving to share the space, a pedestrian only street either prohibits vehicles from using the street at all times, or at specific times.

# STREET TYPES AND MODAL PRIORITY (CONT.)

## 1.8

### 1.8.2 Modal Priority

Modal Priority is a term that refers to the hierarchy of transportation modes (such as walking and wheeling, cycling, transit, driving, and goods movement) that a street is designed for depending on the street type. For example, while accommodating all modes, designing for people walking and wheeling may be the highest priority. Accordingly, the level and quality of service of the street will be focused on maximizing the operation for people walking and wheeling, but still accommodating the flow of other modes of travel. Conversely, a major arterial street in an industrial area may focus on moving goods and motorized vehicles, while still accommodating the other modes.

The modal priority triangle in **Figure 1.7** illustrates the modal priority for a walking and wheeling priority street.

Within a corridor, the highest priority mode (see Section 1.8.2.1) will take precedence in the design process and any trade-of assessment, while lower priority modes will be the first to be reviewed for potential trade-offs. Regardless, the Design Domain concept should be utilized to ensure minimum design requirements are met for all modes needing to be accommodated. Where this cannot occur, the designer may have to look to other adjacent routes in the network to properly provide for the requirements for some users.

For all street types, access for emergency services vehicles is an essential consideration in the street design. All street types must be designed to accommodate emergency service vehicles when the route has been identified for primary access or staging.

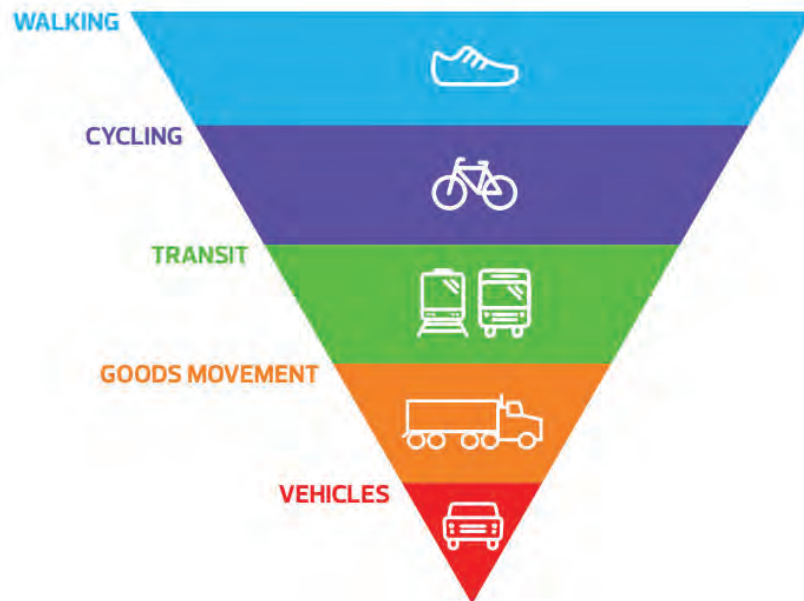

**Figure 1.7** Modal priority triangle for a walking and wheeling priority street



# STREET TYPES AND MODAL PRIORITY (CONT.)

## 1.8

### 1.8.2.1 Establishing Modal Priority

Modal priority can be established through the direction of The City Plan and defined networks such as the Active Transportation network, Goods Movement (Edmonton Truck/Dangerous Goods Routes map), Mass Transit Network, Nodes and Corridors, and identified Pedestrian Priority Areas. In addition, modal priority will reflect direction in District Plans and any Neighbourhood/Area Structure Plans (NSP/ASP), Community Plans, Station Area Plans, Corridor Plans, Area Redevelopment Plans, and other planning documents or tools where a specific modal priority has been identified and approved by City Council. In some cases multiple networks may overlap requiring a more contextual understanding of the tradeoffs and opportunities associated with balancing and prioritizing different travel modes. Some existing direction has been identified below to aid in determining what travel modes should be considered higher priority:

#### Walking and Wheeling Priority

- + Pedestrian Priority Areas
- + The Quarters Overlay
- + Special Area Downtown (Capital City Downtown Plan area)
- + Business Improvement Areas (BIAs)

#### Cycling Priority

Ongoing bicycle network planning in existing and future neighbourhoods

- + Edmonton Bike Plan
- + Neighbourhood Structure Plans
- + Existing Cycling Corridors

#### Transit Priority

- + Existing and future transit network
- + Mass Transit Network Plans

#### Goods Movement Priority

- + Edmonton Truck/Dangerous Goods Route Map

# STREET TYPES AND MODAL PRIORITY (CONT.)

## 1.8

### 1.8.2.2 High Priority Corridor Features

The following provides some examples of the street design characteristics that could exist on streets that are identified as having a certain mode as its top priority.



#### High Priority Walking Corridors:

Streets with active storefronts or with planned walking-oriented commercial frontages; planned pedestrian priority areas; activity of other people on the street; comfortable space to travel, stop (e.g. benches to sit on), and maneuver on foot; and human-scale design (e.g. pedestrian scale lighting) are aspects of street design that provide a good walking and wheeling environment. Public safety, generous sidewalk width, lower design speeds (to minimize speed differential between people walking/wheeling and motor vehicle traffic), and protection from weather will all be present to varying degrees to aid in making a high priority walking and wheeling corridor.



#### High Priority Cycling Corridors:

Bicycle facilities should prioritize health and comfort, connectivity, directness, attractiveness and neighbourhood integration. People riding bikes desire a high degree of connectivity and a system that functions well for people of all skill levels, with minimal detour or delay. People cycling benefit from feeling safe and comfortable, particularly with respect to interactions with vehicular traffic. Bicycle routes that reduce and/or eliminate conflicts with people walking and people driving, can be maintained in all seasons, support social (side-by-side) riding and consider design for higher cycling speeds form the basis of a high priority cycling corridor. Intersection design along these corridors is also critical to the function, comfort, and safety of these corridors for people who cycle. Intersection design along these corridors is also critical to the function, comfort, and safety of these corridors for people who cycle.

## STREET TYPES AND MODAL PRIORITY (CONT.)

# 1.8

### 1.8.2.2 High Priority Corridor Features (cont.)



#### High Priority Transit Corridors

Transit corridors, including light rail transit (LRT), streetcar, and major transit routes, promote economic development around high-quality transit service, while fostering a design scale in which walking and wheeling and cycling actively complement public transit. As major generators of walking trips, high volume transit routes should be prioritized for walking safety improvements in both the immediate surrounding area and major access routes within a short walk of transit service. When redesigning streets to be high priority transit corridors, designers should assess how transit service is impacted not only by the geometry of the corridor, but also its existing signal timing, signal phasing, turns, and other operations that may jeopardize the quality and reliability of service.



#### High Priority Goods Movement Corridors

All truck routes should be designed to permit the safe and effective operation of trucks. To avoid competing demands on the same routes, designation of freight routes should be considered in coordination with mapping of primary walking and wheeling, cycling, and transit corridors, as well as analysis of key access routes, bridge hazards, and industrial or commercial land uses. Design vehicles for goods movement corridors are discussed in Section 3.1.3.3. Considerations for accommodating goods corridors includes vertical clearance, adequate lane width, access, and corner radii.

## STREET TYPES AND MODAL PRIORITY (CONT.)

### 1.8

#### 1.8.2.2 High Priority Corridor Features (cont.)



#### **High Priority Driving Corridors:**

People driving want to get to their destinations in a reliable and safe way with limited friction, interruption, or delay. Design with these goals in mind tends towards limited-access, higher speed roads with limited chance of conflict or surprise. Due to their high speeds and overall mass, drivers feel safest when buffered from other moving vehicles, buses, trucks, and people walking, wheeling, and cycling. Especially when making decisions at high speeds, people driving need adequate lighting and signage, as well as adequate parking provisions at their destinations.

#### **Lower Priority Accommodation**

Many corridors need to accommodate all modes of travel. For modes of travel on those corridors not ranked as “high,” there may still need to be a minimum level of accommodation that is safe and provides basic access. With respect to space within the streets that are provided for these modes of travel, the lower recommended range of the Design Domain tables can serve as a guide. In exceptional instances, values below the recommended range may have to be utilized and will require a Design Exception following the process outlined in Section 2.2.

## SECTION 2.0: DESIGN PROCESS, TRADE-OFFS AND EVALUATION

### 2.0

This Section outlines the design process, including evaluation of design options and trade-off decision making.



# DESIGNING STREETS: DESIGN ZONES AND DESIGN PROCESS

## 2.1

### 2.1.1 Design Zones

In Edmonton, right of way used for streets is defined as a series of zones that include vehicle travel lanes (commonly referred to as the travelled way) and the portions of the street right of way allocated to other street users (e.g., people walking) and utilities (commonly referred to as the roadside or public realm). Not all streets will have all zones. The zones are illustrated in *Figure 2.1a* and *Figure 2.1b* and described on the following pages.



*Figure 2.1a* Design Zones - Local Street Context



*Figure 2.1b* Design Zones - Main Street Context

## DESIGNING STREETS: DESIGN ZONES AND DESIGN PROCESS (CONT.)

### 2.1

#### 2.1.1 Design Zones (cont.)

**Adjacent Land Uses:** This space is the location of land uses that abut the street right of way.

**Frontage Zone:** In the Main Street, or Urban context, adjacent to the building, this space is used as a support and/or extension of the land uses along the street. Uses can include ground floor retail displays, café seating, temporary signage, queuing areas, and other activities to support active use of the street by people and businesses. In the Local, or Suburban context, the frontage zone is typically the private front yard space.

**Pedestrian Through Zone:** This space provides an area for active transportation mobility for people of all ages and abilities to access the land uses along the street. Typically reserved for people walking and wheeling, in some cases this area can be shared with people cycling, and may include segregated areas for those who are walking and those cycling.

**Furnishing Zone:** This space provides an area for signs, street light poles, street trees or landscaping, transit stops, benches, and seating for patios associated with adjacent businesses, in addition to underground and surface utilities and concrete curb. This is also the preferred location for snow storage and can be utilized for low impact development or overland drainage.

**Ancillary Zone:** Located between the Travelled Way and the Furnishing Zone, this space provides the opportunity for various permanent and temporary street uses depending on the context and characteristics of the street. This space is typically considered “on-street”, but is not designed for through traffic. The use of this flexible space can vary along an

individual block and between blocks. Uses can include vehicle parking, parklets, patios (public or associated with an adjacent business), bicycle parking, loading zones, universally designed parking, curb extensions, transit stops, and taxi stands. This space also includes the concrete gutter and, depending on the street design, may be used for snow storage. In cases where protected bike lanes are provided (i.e., part of the Travelled Way), the Ancillary Zone may be located between two parts of the Travelled Way.

**Travelled Way:** This space provides an area for travelling through a street or to access land uses along a street for people travelling by motor vehicle, bicycle, and transit, and for the delivery of goods. The space can include exclusive or shared/general purpose lanes for transit, motorized people and goods movement and may also include centre medians or islands, concrete gutters, refuge areas for people walking, and turning lanes. In non-peak hours, some of the Travelled Way may be used as an area for parking and loading and, in some cases, can also be closed at times to motor vehicle traffic to host events and festivals. The Travelled Way also includes space for people walking, wheeling, and cycling across the travel lanes, as well as deep utilities, including water, sanitary sewer and storm sewer lines.

**Alleys:** Not depicted in Figure 2.1, Alleys provide a through zone for rear access to the Adjacent Land Uses for deliveries and parking, and can be a location for utilities. They can also provide opportunities for public art, walking, wheeling, and cycling connections, and place making.

# DESIGNING STREETS: DESIGN ZONES AND DESIGN PROCESS

## 2.1

### 2.1.2 Design Process

Designing streets should follow the process outlined in Figure 2.2. Typically, since they are generally less constrained, the process for new streets will be less involved in terms of evaluating trade-offs than the retrofit of existing streets.

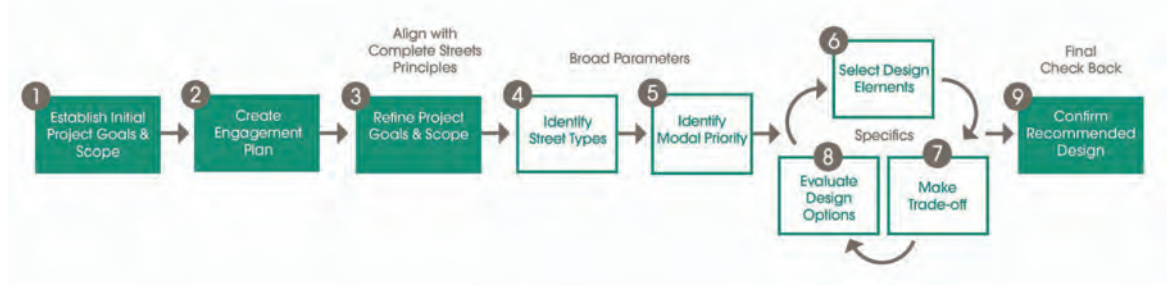

Figure 2.2 Design Process

The steps include:

1. **Establish Initial Project Goals:** Goals for the project initially established to align with the Design Principles and with the City’s Strategic Goals described in The Way Ahead and The Way We Move, and the goals outlined in higher order planning documents such as the City’s TOD Guidelines and relevant, Area Structure Plans (ASPs), Area Redevelopment Plans (ARPs), and/or Neighbourhood Structure Plans (NSPs). Defining the scope for the project should consider both the street and adjacent lands both today and in the future.
2. **Create Engagement Plan:** Stakeholder and public participation occurs throughout the Design Process according to the City’s ‘Public Engagement Policy’ C593 for each stage of the project. There is typically a greater level of engagement for projects in developed areas, including for renewal, reconstruction, and growth projects. The engagement plan will outline the activities that will be used for each of the subsequent steps in the Design Process.
3. **Refine Project Goals and Scope:** Goals for the project are refined from the initial project goals established at the scoping phase of the project to support creation of the project’s Engagement Plan. Input from public and stakeholders is used to refine the project goals and scope of the project, incorporating local knowledge of the area and the issues and opportunities that may not have been known during initial project scoping.
4. **Identify Street Type:** Based on Section 1.8.1, a street will be defined based on the relationship of the buildings to the street, land use context, and functional classification. These three factors are combined to form a composite street type (e.g., street oriented residential collector).



## DESIGNING STREETS: DESIGN ZONES AND DESIGN PROCESS (CONT.)

### 2.1

#### 2.1.2 Design Process (cont.)

5. **Identify the Modal Priorities:** In this step, the modal priorities for a street will be determined by ranking the priority for walking and wheeling, cycling, transit, driving, and delivering goods/services. This ranking is based on the street's typology, the information in Section 1.8.2, and information from the City's strategic plans, Winter Design Guidelines, concept plans, high level planning documents, and land use documents, as well as priorities expressed through engagement and the street's greater role in the overall network. Where required, emergency access must be accommodated regardless of the modal priorities of a corridor.
6. **Select Street Design Elements:** Section 3.0 provides information on the street design elements and the range of design values that can be used to create street cross sections and intersection designs for the identified street type, modal priorities and the results of the engagement process. Street design elements and their associated dimension will be dependent on the project's goals/scope, street type, and modal priority. For new neighbourhoods and in some retrofit situations, a designer may choose to select a standard drawing detail from Chapter 3.0. In so doing, the designer may still choose or need to alter the standard drawing based on the standards and guidance provided in Chapter 1.0, Section 3.0. Design elements may also be required where a new street needs to tie-in or transition to an existing street design. Design elements should consider the placement and location of utilities to ensure current and planned infrastructure can be accommodated.
7. **Make Trade-offs:** Trade-off considerations (i.e., prioritizing competing demands for street space within limited right of way) should occur explicitly throughout the process. Considerations need to include modal priority and determination of appropriate street design elements and corresponding design values as well as impacts on winter operations. Network level operations should also be considered when making trade-offs to ensure consistency along a corridor and to ensure that the trade-offs will not have unintended adverse impacts on adjacent streets. The process to evaluate trade-offs is outlined in Section 2.2.
8. **Evaluate Design Option(s):** Evaluation of design options will be completed using the evaluation guidance outlined in Section 2.3. The evaluation process is iterative and loops back to make tradeoffs as options are created, evaluated, and revised to address deficiencies in the design.
9. **Confirm Recommended Design:** As a final step, the designer should re-examine whether the project design meets the goals and objectives established at the beginning of the Design Process and if the intent of the Design Principles as outlined in Section 1.1 has been achieved. Through discussion with stakeholders, consideration of trade-offs and possible further design changes, stakeholders will then reach agreement that the recommended design meets the established goals and objectives, and the detailed design can proceed.

## TRADE-OFFS AND DESIGN EXCEPTIONS PROCESS

### 2.2

Modes identified as high priority must be accommodated and should be designed using the values in the higher end of the recommended range of the Design Domain, whenever possible. Lower priority modes should be provided at least basic access using design values at the lower end of the recommended range of the Design Domain.

Trade-offs may be required in constrained situations (e.g., limited right of way, utility requirements, and street trees) when determining how to fit multiple modes into the cross section. These trade-offs could, depending on context and project type, include consideration of the following:

- + Reduce the design speed
- + Remove the parking lane on one or both sides of the street
- + Remove medians and turning lanes
- + Remove motor vehicle lanes
- + In exceptional circumstances, place the sidewalk facility next to the curb, and remove or reduce the furnishing zone (if traffic volumes, speeds, and winter operations allow this to be suitable).
- + Acquire additional right of way
- + Remove trees
- + Relocate utilities

Where constraints dictate that a mode cannot be accommodated on a street within the recommended Design Domain values, the broader network should be reviewed to determine if a mode can be accommodated on a parallel street.

Designers will need to justify the use of values outside the recommended Design Domain values through development of a Design Exception.

According to the TAC GDG, “[a] Design Exception is a case where one or more design elements for one or more modes of transportation falls outside normal boundaries of the Design Domain for that design element. It is an extraordinary situation and one where the design needs to be tailored to its context through sound professional judgment. Design Exceptions can be initiated at any stage of a project; how they are addressed needs to reflect the range of relevant legal, policy, and organizational practices.”

A Design Exception may be required to provide a design that is implementable (e.g., constrained right of way locations) or may be required to provide a non-traditional or alternative design that will result in significantly improved performance. Examples for when Design Exceptions may be required include the following:

- + Constraints, such as right of way, buildings, utilities, or heritage designations that may not be able to be changed or moved.
- + Multimodal safety audit findings that clearly show critical risks that require mitigation.
- + Emerging best practices or a trial installation that will be used to test a new design or operational approach.

## TRADE-OFFS AND DESIGN EXCEPTIONS PROCESS (CONT.)

### 2.2

Design Exceptions need to be evaluated to determine performance, risks, and mitigation strategies and documented to communicate design decisions. Reasons to justify a Design Exception could include improved safety performance or mitigating community impacts. In all cases, Design Exceptions require the development of alternatives, identification of risks/mitigations, and rationale for the decisions made and should follow a thorough, repeatable, and well-documented process. **Figure 2.3** illustrates the steps of a typical Design Exception process. More information on assessment and documentation of Design Exceptions can be found in the TAC GDG, Section 1.5. A sample design exception form is provided in **Appendix B**.

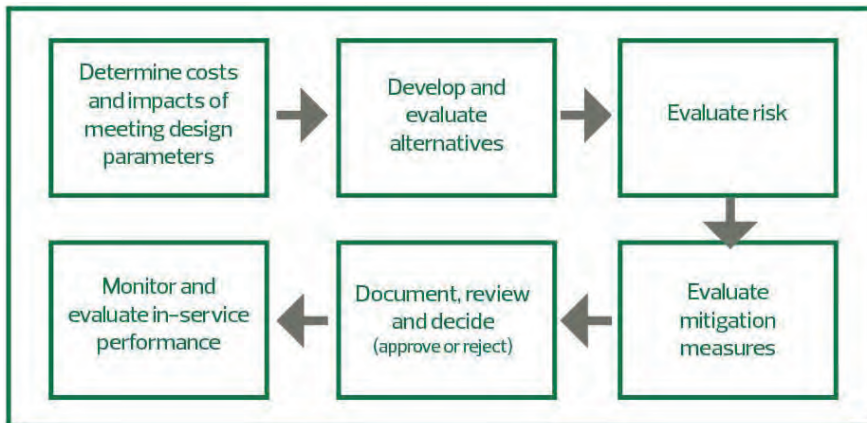

**Figure 2.3** Design Exception Process

Deviations from the specified recommended range of the Design Domain may be the premise for claims that the geometric design of the street is not “safe.” Proven effective strategies against these types of claims include compliance with policies related to flexible design, use of appropriate engineering judgment supported by quantitative analysis, and good, consistent documentation of the reason for the decision including a summary of mitigating strategies considered and implemented.

## ANALYSIS PROCESS TO EVALUATE STREET DESIGN

### 2.3

An analysis process for evaluation of street designs should be used to determine a preferred option from various alternatives and an analysis process is also needed for the evaluation of the performance of a street design that has been implemented. In both cases, evaluation criteria should cover the following areas:

- + Policy Alignment - does the design align with municipal goals, objectives, and principles
- + Street Function - does the design meet the approved/required mode priorities of the street?
- + Operations & Maintenance - does the design allow for the intended operations and cost-effective long term maintenance, including consideration of utilities and drainage?
- + Future Planning - does the design work in the future and can it be easily adapted?
- + Constructability - is the design implementable?
- + Sustainability - can the amount of throw-away construction be reduced and are trees able to survive?

Specific data to inform these evaluation criteria should include, at a minimum:

- + Volume of current and projected future users
- + Collision data and observational data
- + Speeds of motor vehicle traffic
- + Travel times for all modes
- + Utilization of public space
- + Environmental and health benefits
- + Safety performance
- + Drainage and winter maintenance

The evaluation of street designs should be completed by a multi-disciplinary team drawn from affected City of Edmonton departments to reflect the multidimensional impact the design of streets has on residents, businesses, and City operations. Where possible, the team should include City staff responsible for policy, planning, design, operations, construction, and maintenance.

The evaluation process should be considered whenever a design deviates from the target values contained in this document, or wherever Design Exceptions are utilized. The decision to undertake evaluation of a design rests with the designer, and is meant to provide valuable information regarding performance of certain designs for influencing future projects.

## SECTION 3.0: DESIGN REQUIREMENTS FOR COMPLETE STREETS DESIGN

### 3.0

This Section includes the guidance and design requirements for street and off-street path/trail design in Edmonton.



## GENERAL

### 3.1

#### 3.1.1 Guiding Documents

The Standards presented in this document are to be used in the design of Edmonton streets. They are built on the following municipal, provincial, national, and international guidance:

- + Geometric Design Guide for Canadian Roads (GDG), Transportation Association of Canada (TAC), 2017;
- + Canadian Roundabout Design Guide, TAC, 2017;
- + Manual of Uniform Traffic Control Devices for Canada (MUTCD-C), TAC, 2014;
- + Canadian Guide to Neighbourhood Traffic Calming (CGNTC), TAC, 1998;
- + Main Streets Guideline (MSG), City of Edmonton, 2016;
- + Winter Design Guidelines (WDG), City of Edmonton, 2016;
- + Alberta Transportation Highway Geometric Design Guide, Alberta Transportation, 1999;
- + Design Manual for Bicycle Traffic (CROW Manual), CROW, 2016; and
- + Accessible Design for the Built Environment, Canadian Standards Association (CSA), 2004.

#### 3.1.2 Human Factors

Streets are built for use by people whether they are walking and wheeling, cycling, driving, delivering goods, or using transit. Human abilities determine how far we can see, the limits of our peripheral vision, how quickly we react, the extent of our mobility, and how we perceive and process information.

**Figure 3.1** illustrates how a variety of physical, intellectual, and psychological influences relate to a person's ability to react to a given situation.

These human abilities impact design decisions and design element values by impacting human actions. Consequently, human traits need to be considered in design. Human factors are of significant interest in the street design process as there is a close link between how streets are built and how people use them. If perceptual clues are clear and consistent, the task of adaptation is made easier and the response of people driving, walking and wheeling, and cycling will be more appropriate and uniform. For street design this translates into two foundational principles:

- + It is important to design a street so that it generally conforms to what users expect from that type of street based on previous experience (e.g., user expectation); and
- + It is important to provide street users with sufficient time to detect, identify, and react to hazards in the street (e.g., user perception and reaction).

## GENERAL (CONT.)

**3.1** Different street users have different performance capabilities and design needs, which can be categorized in terms of the “type” of user being considered for design purposes. When contemplating design challenges, designers consider different “design users” in the same way they consider different “design vehicles.”

Design users will include the wide range of modes including designing for people of all ages and abilities consistent with Universal Design principles. They will also represent a range of people, from those who are young and inexperienced, to those who are older, and those with challenges resulting from failing sensory and cognitive faculties and physical disabilities. Tier trip purposes may also differ, from those who are driving/ cycling/walking/wheeling for pleasure to those who are commuting, from those who are in a hurry, to those who are not. Perhaps most importantly, design users

will include those who are familiar and those who are unfamiliar with the street.

In considering human abilities and traits, it is important to remember that they vary from person to person and from situation to situation. For example, a numerical value for reaction time should not be thought of as fixed, even though a fixed numerical value may be assumed for design purposes. Older adults will often have slower walking speeds, reduced perceptions, and increased stopping distances. Those with mobility impairments may require additional time to start a movement, especially when using mobility aids. Street users of all ages and abilities also adapt to perceived and anticipated conditions.

More information on Human Factors and the related topic of Design Consistency can be found in Sections 2.2 and 2.7 of the TAC GDG.

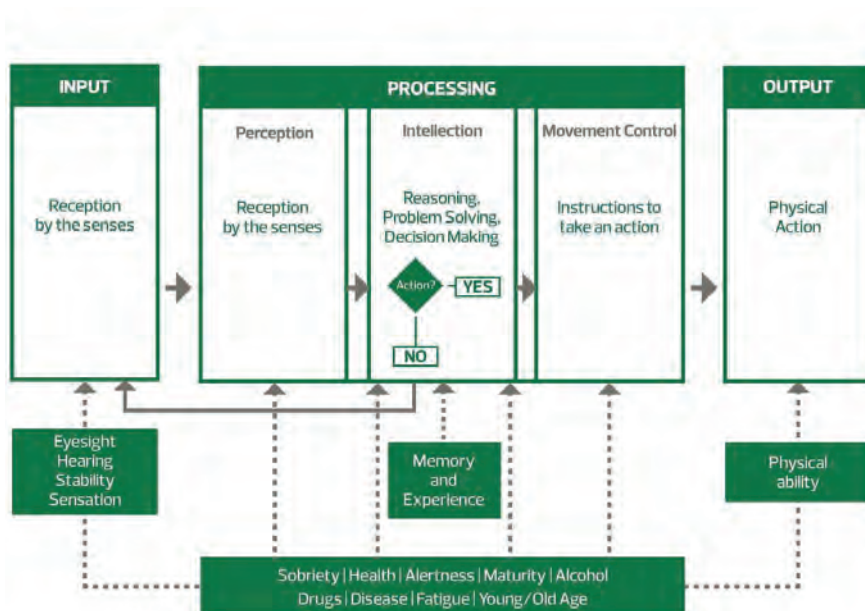

Figure 3.1 Human Factors (Human Factors Lecture Outline. W.S Homburger)

## GENERAL (CONT.)

# 3.1

### 3.1.3 Design Users & Design Vehicles

Designing streets requires an understanding of the dynamics and functional requirements of people and their various modes of transportation. This section defines Design Users and Design Vehicles to be used in the design of Edmonton streets.

#### 3.1.3.1 Design Users & Vehicles for Walking and Wheeling

Walking and wheeling are the most universal and equitable forms of travel. Most trips, regardless of mode used, start or end with walking. People walking and wheeling are also among the most vulnerable of street users.

For street design, people walking and wheeling also includes those running, or standing; people using manual/motorized wheelchairs or scooters; people using canes or walkers; people pushing strollers or carts; people pulling sleds; people pushing bicycles; and users of various other low-speed forms of human locomotion (e.g., skateboards, cross-country skiing). Applying the Universal Design Principles (see Section 1.5) is critical in achieving an accessible journey for all people that are walking or wheeling.

The typical width of a person is 0.5 m, measured at the shoulders, with a corresponding operating envelope of 0.75 m. When walking with a child, service animal, side by side, or in a wheelchair the person has a wider horizontal operating dimension. Figure 3.2 illustrates the varying horizontal operating dimensions for people walking, walking with a service animal, and using a mobility aid.

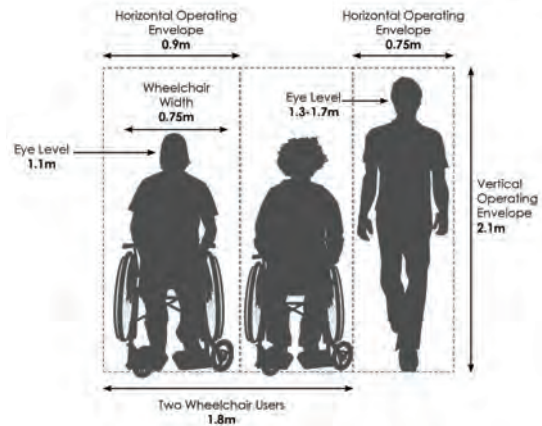

Figure 3.2 Walking/Wheeling Operating Space

The dimensions provided in Table 3.1 summarize the recommended Design Domain values for horizontal and vertical operating envelopes for people walking and wheeling and are consistent with CSA's Accessible Design Standards.

Table 3.1 Design Domain for People Walking and Wheeling (in m)

Parameter: Operating Envelope	Recommended Values	
	Horizontal Operating Envelope	Vertical Operating Envelope
Person Walking	0.75	2.10
Manual Wheelchair or Scooter	0.90	2.10
Person Walking with Child / Person Walking with Service Animal / Two People Walking / Two Wheelchair Users Passing	1.80	2.10



## GENERAL (CONT.)

### 3.1

All sidewalks in Edmonton should be designed at minimum to accommodate two passing wheelchair users, with a minimum clear width of 1.8 m. Design Domain values for other sidewalk users have been included for consideration when in a constrained situation.

When selecting the width of sidewalks, consideration must be given to the impacts of snow accumulation and clearing. For example, some sidewalks may need to be widened to accommodate the windrows from snow clearing of the Pedestrian Trough Zone or adjacent travel lane. Recommended sidewalk widths in the Edmonton context can be found in Section 3.3.4.2 and Table 3.19.

Wherever possible, the use of monolithic sidewalks along collector and arterial streets should be avoided. Where this is not possible, additional sidewalk width should be provided to enhance safety and comfort for people walking and wheeling and to accommodate snow clearing windrows from the adjacent street in winter. At minimum, an additional 0.5 metres of sidewalk width must be provided for monolithic sidewalks adjacent to arterial and collector streets.

Where there is a barrier or vertical obstruction adjacent to a sidewalk or walkway, an additional horizontal

clearance of 0.2 m should be provided in addition to the horizontal operating envelope. If the walking and wheeling facility is shared with people cycling, see Section 3.1.3.2 for horizontal clearance requirements.

For information on design requirements for in-line skating, refer to Section 5.2.2.2 of the TAC GDG and further guidance is available in the TAC In-line Skating Review.

For Universal Design, the grade of walking and wheeling infrastructure is also an important consideration. Guidance on grades is provided in Section 3.5.7.

#### 3.1.3.2 Design Users & Vehicles for Cycling

Complete Streets principles recognize the need to design for the full range of user ages and abilities of people who may ride a bicycle. Consistent with TAC's GDG, this broad group could be defined as Geller's "Interested but Concerned" segment or AASHTO's "Casual and Less Confident" segment, and embodies the widest practical range of ages and abilities. Based on surveys in Edmonton, this group makes up about 45% of the population as illustrated in *Figure 3.3*.

<sup>1</sup> Transportation Association of Canada (TAC), 1997. "Section 3.3.1" In-line Skating Review. Phase 2 Technical Report. Ottawa: Transportation Association of Canada.

<sup>2</sup> See for example, such sites as [www.completestreetsforcanada.ca](http://www.completestreetsforcanada.ca) [updated 2015] and [www.completestreets.org](http://www.completestreets.org) [updated 2016] [Viewed November 10, 2016].

<sup>3</sup> See Geller, R. 2009. "Four Types of Cyclists". City of Portland Bureau of Transportation. <http://www.portlandonline.com/transportation/index.cfm?a=237507> [Viewed November 11, 2016]; and Dill, J., & McNeil, N. 2013. "Four Types of Cyclists?" Transportation Research Record: Journal of the Transportation Research Board, 2387(1), pp. 129-138.

<sup>4</sup> American Association of State and Highway Transportation Officials. 2012. Guide for the Development of Bicycle Facilities, 4th Edition. Washington, DC: American Association of State and Highway Transportation Officials.

<sup>5</sup> Transportation Committee Report 2013TS0442, March 13, 2013.

## GENERAL (CONT.)

### 3.1

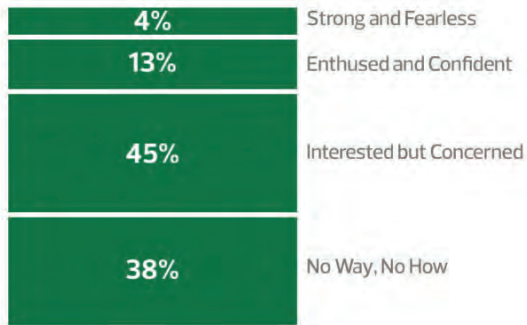

Figure 3.3 Edmonton's Market for Cycling (Source: City of Edmonton, 2013)

Most in the "Interested but Concerned" group ride bicycles recreationally, but 85% cite fears of safety as the barrier to riding more often. Unless otherwise indicated, the design requirements included in this document, especially for facility types and facility selection, are based on the "Interested but Concerned" group of users in consideration of all ages and abilities principles.

When designing for this group of users the following principles should be considered:

- + **The bike network should be efficient and direct** - stopping and starting is very energy intensive and should be kept to a minimum. Routes should be direct and minimize out of direction travel
- + **The bike network should be accessible and safe for all users** - at low speeds bicycles are unstable. Tight turns, unevenness, and narrow facilities are difficult to navigate and are barriers to less confident cyclists and people using non-standard bikes such as trailers and handcycles

- + **The bike network should be comfortable in all-seasons** - design to provide shelter from sun, wind and rain, and allow for efficient snow and ice control to accommodate year-round riding
- + **The bike network should be social** - people on bikes should be able to ride side-by-side. This allows people to ride together, parents to supervise children, and passing

Figure 3.4, illustrates the physical design dimensions and operating envelope for a person riding a bicycle. The envelope illustrated is relevant to the design of on- and off-street bicycle facilities as well as bicycle parking.

## GENERAL (CONT.)

### 3.1

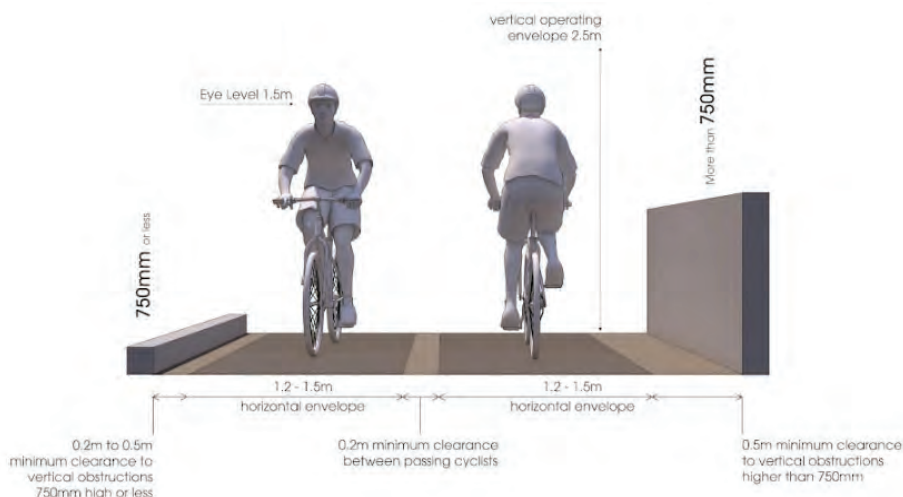

**Figure 3.4** Bicycle Operating Space

The dimensions provided in **Table 3.2** below summarizes the recommended Design Domain values for the horizontal, lengthwise, and vertical operating envelopes for people cycling.

**Table 3.2** Design Domain for People Cycling (in m)

Parameter: Operating Envelope	Recommended Values	
	Recommended Lower Limit	Recommended Upper Limit
<b>Horizontal Operating Envelope</b>	1.2	1.5
<b>Lengthwise Operating Envelope</b>	1.8	3.0
<b>Vertical Operating Envelope</b>	2.5	N/A

The higher ends of the horizontal operating envelope are most appropriate for steep grades.

In addition to the horizontal operating envelope, the following horizontal clearances should be provided:

- + The width of the gutter pan is not considered part of the horizontal operating envelope. The minimum

clearance from the face of curb should be 0.25 m for a 250 mm gutter pan or 0.50 m where there is a 500 mm gutter pan.

- + Minimum horizontal clearance of 0.2 m is required from vertical obstructions of 100 mm to 750 mm in Height;
- + Minimum horizontal clearance of 0.5 m is required for vertical obstructions greater than 750 mm in height; and
- + Horizontal clearance of 0.2 m should be provided to accommodate passing maneuvers between cyclists, either for oncoming or overtaking movements.

+ On bridges with active mode connections additional horizontal offsets should be provided as follows:

- + Shared Pathway width including 0.6m offset: 4.2m
- + Sidewalk width including 0.5m offset: 2.8m

The higher values noted in the lengthwise operating envelope represent requirements to accommodate bicycles with attached trailers and for cargo bikes. This dimension is important when designing medians intended for refuge, when considering horizontal alignments, and the design of intersections.

## GENERAL (CONT.)

### 3.1

The vertical operating envelope is used in consideration of vertical clearances which is discussed in Section 3.2.7.2.

More information on vertical alignment for bicycle facilities can be found in Sections 3.2.7.2 and 3.5.7, while information on horizontal alignment can be found in Section 3.2.6.3.

#### 3.1.3.3 Design Vehicles for Driving, Transit, and Goods/ Services

The physical characteristics of the vehicles using a street define many geometric design elements including, amongst others, intersections, site access configurations, and vertical clearance. As part of the design process, it is necessary to identify all vehicle types using a street and then to select a representative design vehicle whose turning dimensions (i.e., dimensions affecting tracking or turning behaviour) and other characteristics (e.g., height of eye, overall length, and performance characteristics) are then used to establish the relevant design vehicle parameters for geometric design.

Design vehicle categories are established by examining all vehicle types, selecting general class groups on the basis of use and turning behaviour, and defining a representative size of vehicle within each classification. Three general classes of vehicles have been established based on research commissioned by TAC:

- + Minimum horizontal clearance of 0.2 m is required from vertical obstructions of 100 mm to 750 mm in Height;
- + Trucks - includes single-unit trucks, truck tractor-semi-trailer combinations, and trucks or truck

tractors with semitrailers in combination with full trailers; and,

- + Buses - includes single unit buses, articulated buses, and intercity buses.

The **Design Vehicle** is typically the vehicle with the largest turning radius frequently required to maneuver a turn at the intersection and, as such, turns should be made with relative ease. The Design Vehicle also assists in establishing the width of elements within the Travelled Way and Ancillary Zone.

**Control Vehicles**, on the other hand, are typically the largest vehicle occasionally required to maneuver a turn at an intersection corner, but are relatively low in frequency and may have less available space to maneuver. The space needed for maneuvering by Control Vehicles may occur by turning into non-curb-side travel lanes or encroaching into opposing lanes (provided measures are taken to manage the conflicts).

**Table 3.3** defines Design Vehicles and Control Vehicles to be used for street design in Edmonton based on street type. Though not specified as the Design Vehicle for each street type, the transit bus (B-12) should be used as an additional design vehicle at intersection corners that are part of a bus route. **Figures 3.5** through 3.11 provide dimensional details for the Design Vehicles. Typical vertical heights of trucks range from 4.15 m to 4.25 m which can be used in the assessment of vertical clearance (see Section 3.2.7.1).

Guidance on Design and Control Vehicles for Edmonton's Main Streets can be found in the City of Edmonton Main Streets Guideline.

<sup>6</sup> Lea Associates. 1996. Design Vehicle Dimensions for Use in Geometric Design, Ottawa: Transportation Association of Canada.

## GENERAL (CONT.)

### 3.1

**Table 3.3** Design Vehicles by Context

Street Classification	Design Vehicle	Control Vehicle <sup>2</sup>	Control Vehicle Allowable Encroachments
<b>Pedestrian Only Streets &amp; Shared Streets</b>	Bicycle	FT	FT must maneuver within hard surfaced areas with 0.3 m clearance to pavement edge and any vertical obstacles.
<b>Reverse Housing Lane</b>	P	WT, FT	WT, FT must maneuver within hard surfaced areas with 0.3 m clearance to pavement edge and any vertical obstacles.
<b>Alley</b>	P	WT	WT must maneuver within hard surfaced areas with 0.3 m clearance to pavement edge and any vertical obstacles.
<b>Local (Non-Industrial)</b>	P	WT, FT, MSU	Maneuver within hard surfaced areas with 0.3 m clearance to pavement edge and any vertical obstacles.
<b>Collector (Non-Industrial)</b>	B-12	WT, FT	Maneuver within hard surfaced areas with 0.5 m clearance to pavement edge and any vertical obstacles.
<b>Arterial<sup>1</sup> (Non-Truck Route<sup>3</sup> or Truck Route<sup>3</sup> within Mature Neighbourhood Overlay)</b>	B-12	WB-21	Encroachment into adjacent lanes in same direction at major intersections (opposing lanes at minor intersections)
<b>Main Streets<sup>1</sup></b>	MSU	B-12	Encroachment into non-curb side lanes in same direction on receiving street permitted.
<b>Industrial Local</b>	WB-21	WB-36	Encroachment into opposing lanes permitted at intersections (local/collector)
<b>Industrial Collector</b>	WB-21	WB-36	Encroachment into opposing lanes permitted at intersections (local/collector)
<b>Arterial<sup>1</sup> (Truck Route<sup>3</sup> Outside of Mature Neighbourhood Overlay<sup>4</sup>)</b>	WB-21	WB-36	Encroachment into adjacent lanes in same direction permitted at major intersections (opposing lanes at minor intersections)
<b>Freeways/Expressways</b>	WB-21	WB-36	Encroachment into adjacent lanes in same direction at ramp intersections only.

**Legend (Design, Control Vehicles):**

P = Passenger Car;  
 MSU = Medium Single Unit Truck;  
 FT = City of Edmonton Fire Truck;  
 WT = City of Edmonton Waste Collection Truck;  
 B-12 = Standard Single Unit Bus;  
 WB-21 = Semi-Trailer (Alberta Transportation); and  
 WB-36 = Turnpike Double (Alberta Transportation).

**Notes:**

- Where a Main Street is a truck route, the design requirements for a Main Street shall govern.
- Minimum 6.0 m clear width required to accommodate FT operations. This must be provided where FT is a control vehicle and can be

accommodated by including the width of opposing lanes, as well as parking lanes on local streets.

- For Truck Routes refer to the latest City of Edmonton Truck Route Map.
- For Mature Neighbourhood Overlay refer to the latest City of Edmonton Mature Neighbourhood Overlay map.

Should a designer select a Design or Control Vehicle that is different than those listed in **Table 3.3**, a Design Exception is required.

For further information and details on the above Design Vehicles and other potential Design Vehicles, refer to TAC GDG Section 2.4 (e.g., articulated buses).

**GENERAL** (CONT.)

**3.1**

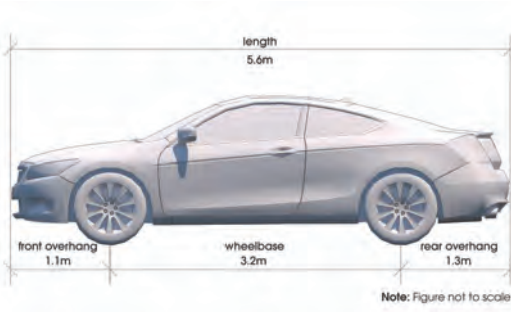

**Figure 3.5** Passenger Car Dimensions

Width = 2.0 m  
Turning Radius = 6.3m

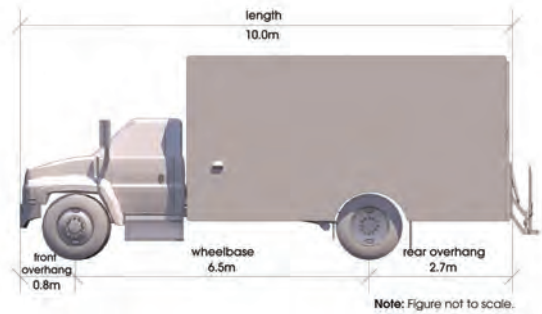

**Figure 3.6** Medium Single Unit Truck Dimensions

Width = 2.6 m  
Turning Radius = 11.1m

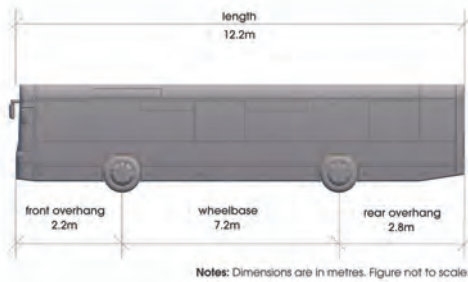

**Figure 3.7** B-12 Standard Single Unit Bus Dimensions

Width (w/o mirrors) = 2.6 m  
Width (w/mirrors) = 3.15  
Turning radius = 12.9 m

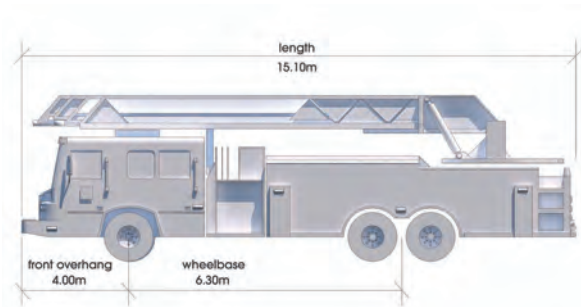

**Figure 3.8** City of Edmonton Fire Truck Dimensions

Width (w/o mirrors) = 2.6 m  
Turning radius = 12.8 m

**GENERAL** (CONT.)

**3.1**

7,300 kg (16,094 lbs) - Front Axle Legal Weight  
 17,000 kg (37,479 lbs) - Rear Axle Legal Weight  
 length 10m



Width (w/o mirrors) = 2.6 m Width (w/mirrors) = 3.15 m Turning radius = 12.8 m

**Figure 3.9** City of Edmonton Waste Collection Truck (Front-Loading)

[See City's Waste Collection Vehicle Specifications for mode details on Front and Manual Side-Loading Vehicle Dimensions]

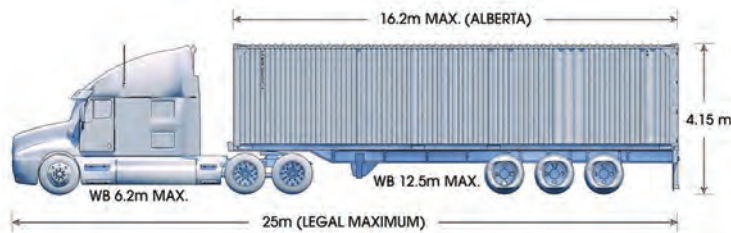

Widths = 2.6 m Turning radius = 12.8 m

**Figure 3.10** WB-21 Tractor Semi-Trailer Dimensions

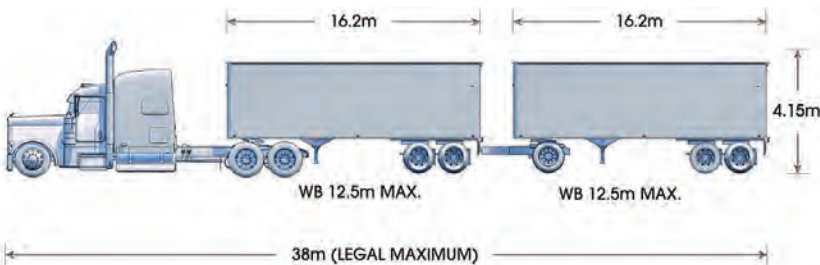

\* ALLOWED UNDER SPECIAL PERMIT ONLY IN ALBERTA. THE PERMIT SPECIFIES THE ALLOWABLE ROUTES ON WHICH VEHICLES IN EXCESS OF 25M OVERALL LENGTH CAN BE USED. REFER TO PROVINCIAL MAP.

Widths = 2.6 m Turning radius = 12.8 m

**Figure 3.10** WB-21 Tractor Semi-Trailer Dimensions

## TRAVELLED WAY

### 3.2

The Travelled Way is the space provided for travelling through a street or to access land uses along a street for people travelling by motor vehicle, bicycle, and transit, and for the delivery of goods. The space can include exclusive or shared/general purpose lanes for transit, motorized people and goods movement and may also include centre medians or islands, concrete gutters, refuge areas for people walking, and turning lanes. In non-peak hours, some of the Travelled Way may be used as an area for parking and loading and, in some cases, can also be closed at times to motor vehicle traffic to host events and festivals. The Travelled Way also includes space for people walking, wheeling, and cycling across the travel lanes.

The following sections describe the various design elements that contribute to the overall design of the Travelled Way.

Information on Offsets for design elements with respect to the Travelled Way can be found in Section 3.7. This includes horizontal offsets and clearances to utilities, poles, and trees. Requirements for Sight Distances and Clear Sight Triangles at intersections can be found in Section 3.6.1.4.

#### 3.2.1 Design Speed

Travel speeds have a significant impact on the safety and efficiency of the transportation system. Inconsistencies between the Operating Speed, Design Speed, and the Posted Speed can create unsafe conditions.

Operating Speed refers to the actual travel speed of vehicles at a time when traffic volumes are low and drivers are free to choose the speed at which they travel without reductions due to congested conditions

In general, the intended Operating Speed should be equal to or less than the Design Speed. There is evidence that design treatments, such as narrow lanes, traffic calming measures, on-street parking, street oriented buildings, and trees located closer to the street result in drivers travelling at lower Operating Speeds. This suggests that drivers behave less aggressively and more cautiously on narrower streets and is the basis for “self-explaining roads” as well as the approach taken to Safe Systems and Vision Zero in these CSDCS (see Section 1.3).

Research has shown the probability of fatalities increases significantly when impact speeds are above 50 km/h (see Section 1.3). In order to mitigate these negative impacts, streets in areas with buildings oriented to the street should be designed for slower, walking-compatible motor vehicle travel speeds as a response to higher levels of people walking. These speeds should be kept at or below 50 km/h wherever possible.

The choice of Posted and Operating Speed of a street also has significant impacts on the placement and location of furnishings in walkable environments, as well as the comfort and safety of pedestrians and cyclists. Where lower speeds cannot be achieved, the negative impacts should be mitigated through increased sidewalk buffers for people walking, increased physical separation from motor vehicle traffic for people cycling, and safe and convenient crossing opportunities for all vulnerable users.



## TRAVELLED WAY (CONT.)

### 3.2

#### 3.2.1.1 Design Speeds for Streets

Design Speed for Edmonton streets will be applied as follows:

- + Design Speed = Posted Speed for:
  - + Local Streets
  - + Collector Streets
  - + Other Non-Arterial streets with Posted Speeds of 50 km/h or less
- + Design Speed = Posted Speed + 10 km/h for:
  - + Arterial Streets with Posted Speed of 60 km/h or greater
  - + Freeways/Expressways (Design Speed may equal Posted Speed + more than 10 km/h depending on Posted Speed); and
- + Arterial Streets with Posted Speed = 50 km/h or less:
  - + Use Design speed = Posted Speed for the following elements:
    - + lane widths, tapers, and horizontal offsets
  - + Use Design Speed = Posted Speed + 10 km/h for the following elements:
    - + horizontal alignment, vertical alignment, and intersection sightlines.

**Table 3.4** outlines the recommended Design Domain and City of Edmonton target value for motor vehicle design speed for through movements as well as turn movements (see Section 3.6.2 for more information on motor vehicle turning speeds).

Design Speed ranges are based on aspects such as land use context, building orientation in relationship to the street, functional classification of the street, types of interactions that can occur between street users, and mobility goals of the street section. While higher speed of travel for people operating vehicles, transit users, and goods movement will result in shorter travel times, the detrimental influence this higher speed can have on other street users, the built environment, and severity of collisions must be considered. The table allows the designer to establish the design speed for a street through the engagement process, review of historic safety performance, and consideration of the above noted factors at the early stages of design.

## TRAVELLED WAY (CONT.)

### 3.2

**Table 3.4** Design Domain for Design Speeds & Posted Speeds (in km/h)

Contextual Street Classification (building relationship to the street, land use, and functional classification)	Design Domain Recommended Range		City of Edmonton Target Value	
	Recommended Lower Limit	Recommended Upper Limit	Design Speed	Posted Speed
<b>Alleys, Reverse Housing Lanes, Shared Streets, and Pedestrian Only Street (all contexts)</b>	5	20	20 <sup>2</sup>	20 <sup>2</sup>
<b>Local Streets (all contexts except Industrial)</b>	30	40	50 <sup>2</sup>	50 <sup>2</sup>
<b>Local Industrial Streets</b>	30	50	50	50
<b>Street Oriented Collector Streets (all land use contexts)</b>	30	50	50 <sup>2</sup>	50 <sup>2</sup>
<b>Non-Street Oriented Collector Streets (except Industrial Areas)</b>	40	50	50	50
<b>Non-Street Oriented Industrial Collector Streets</b>	50	60	50 <sup>1</sup>	50
<b>Street Oriented Arterial Streets (all land use contexts)</b>	40	50	50 <sup>1</sup>	50
<b>Non-Street Oriented Arterial Streets (all land use contexts)</b>	50	70	70	60
<b>Freeways/Expressways</b>	80	120	90+	80+

**Notes:**

1. Use 60 km/h Design Speed for horizontal alignment, vertical alignment, and sightlines for street oriented arterial streets.
2. Posted speed is subject to Council Approval and terms outlined in the Municipal Government Act, Traffic Safety Act and Speed Zones Bylaw 6894. Speeds should be reviewed in the future and reflect the outcome of Council decisions.

## TRAVELLED WAY (CONT.)

### 3.2

#### 3.2.1.2 Design Speeds for Pathways & Bikeways

Bike lanes and bike paths should have a Design Speed that is at least as high as the preferred speed of the faster cyclists who will use the facility. shared pathways must also take into account the expectations of the other users of a facility, including those with mobility issues.

The Design Domain ranges for bicycle travel are based on aspects such as land use context, building

orientation in relationship to the street, types of interactions that can occur between street users, and mobility goals of the bicycle infrastructure.

Facilities with higher design speeds must account for slower-moving users by providing elements that facilitate safe passing, such as additional facility width, pullout refuges, and separation of travelers by mode and/or direction of travel.

**Table 3.5** Design Domain for Design Speed of Pathways & Bikeways (in km/h)

Parameter: Design Speed	Design Domain Recommended Range		City of Edmonton Target Value
	Recommended Lower Limit	Recommended Upper Limit	
Where: + Uneven pathways + Low coefficient of friction + Protected bike lanes or pathways with multiple conflict points and insufficient sightlines + High usage by vulnerable users (e.g. schools, parks etc.) + Geometric constraints	10	20	20
Neighbourhood Route	20	30	20
District Connector Route	30	50	30

**Notes:**

- Where the downgrade exceeds 5% for more than 60m, or strong tailwinds are likely due to prevailing wind conditions, design speed should be increased to ≥40 km/h.

## TRAVELLED WAY (CONT.)

### 3.2

#### Electric Bikes

Electric bikes, also called e-bikes, power assisted bikes, or power bicycles are growing in popularity. E-bikes use a small electric motor to aid with pedalling, which can support cycling in a city by eliminating barriers posed by long distances and hills, as well as for those with reduced physical fitness.

A study completed in 2015 by the University of Tennessee found that electric bike users have similar behaviours, including travel speeds, as those of users of regular bicycles.<sup>7</sup> Because speeds and safety behaviours for people cycling with these two types of bicycles are similar, the design conditions to permit these users on cycling facilities should not require deviations from the Design Domain for Design Speed identified in this section.

#### 3.2.2 Lane Widths

##### 3.2.2.1 Functions of Lane Width

Lane width has an impact on driver behaviour, sidewalk animation, and safety of users of all transportation modes. Lane widths must balance the safety, access, and comfort for all users, including people walking and wheeling, cycling, riding transit, driving, and delivering goods.

Vehicle lanes are intended to perform the following functions:

- + Delineate space within the Travelled Way that is primarily used by motor vehicle traffic including transit and goods (although bicycle traffic can also use these lanes); and
- + Reduce traffic conflicts between vehicles travelling in the same or opposite direction.

##### 3.2.2.2 Design Considerations

The TAC GDG discusses the design considerations for lane widths in Section 4.2. Topics described include safety, Design Speed (and desirable Operating Speed), vehicle type, multimodal traffic volumes, climatic conditions, utility and streetscaping elements, and land use context.

TAC GDG Section 4.2.2 identifies three links between safety and lane width:

- + The wider the lanes, the larger the average separation between vehicles operating in adjacent lanes. This may provide a larger buffer to absorb the small random deviations of vehicles from their intended path. On streets that are identical except for lane widths, drivers may tend to drive faster and follow the preceding vehicle more closely on a street that has wider lanes.<sup>8</sup> Slower speed limits, when coupled with wider lanes, can also result in poor compliance with the posted speed;
- + A wider lane may provide more room for correction in near-collision circumstances. For example, a moment's inattention may lead a vehicle to drift into an adjacent lane. In the same situation, if the driving lane was wider, the driver's moment of inattention may have less serious consequences; and
- + However, wider lane widths may induce higher operating speeds by creating an open environment with little "side friction". In urban areas, this can be linked to reduced safety performance for people walking, wheeling, and cycling. Higher speeds increase stopping distances and increase the severity of collisions.

<sup>7</sup> Langford BC, Chen J. Cherry CR. (2015) Risky riding: Naturalistic methods comparing safety behavior from conventional bicycle riders and electric bike riders. <https://www.ncbi.nlm.nih.gov/pubmed/26093098>

<sup>8</sup> Hauer, E. 1998. "Literature Review and Analysis on Lane Widths". University of Toronto.

## TRAVELLED WAY *(CONT.)*

### 3.2

Research and analysis completed for the City of Edmonton <sup>9</sup> reviewed the relationship between travel lane width, operating speeds, and safety. Key findings of this local review include:

The relationship between lane width and safety is complex and difficult to isolate as there are many factors which contribute to safety performance;

Use of the Design Domain concept for lane width decisions is appropriate; and

Speed should be a primary factor in setting context sensitive design guidelines for lane width. For high speed streets, lane widths towards the lower end of the design domain lanes should be avoided. For low speed streets, lane widths towards the lower end of the design domain should be used to encourage Operating Speeds consistent with the Design and Posted Speeds.

#### 3.2.2.3 Lane Width Design Domain

Design Domain and design target values for lane widths in Edmonton, are shown in Tables 3.6a and 3.6b based on the Design Speed. The designer should begin with the target value and adjust as necessary within the recommended Design Domain when considering factors discussed in TAC GDG Section 4.2 and those listed below:

- ✦ Deviating towards narrower lane widths in the Design Domain may increase the need for more frequent snow clearing and increased off-site snow storage. Designers should consider snow storage when selecting lane widths and designing the street as whole;

- ✦ Higher motor vehicle volumes will not generally justify installing wider lanes, but could justify installing additional lanes. Higher volumes of truck traffic, transit vehicles, and people cycling and walking and wheeling may justify increasing widths of their respective lanes/facilities to minimize conflicts and improve comfort for all users;

Comprehensive evaluation and caution should be exercised when deviating toward lower bounds of the lane width Design Domain on high speed streets (i.e., over 60 km/h posted speed) or where deviating towards the upper bounds on low speed streets; and Wider parking lanes may be justified on facilities with high parking utilization and turnover, or frequent large truck parking, to reduce sideswipe, rear end, and dooring conflicts with people cycling

<sup>9</sup> Fireseeds North. 2017. "Minimum Lane Widths for the City of Edmonton."

## TRAVELLED WAY *(CONT.)*

### 3.2

Before selecting lane widths, the designer should review the design considerations described above and the following detailed considerations outlined in the 2017 Fireseeds North report "Minimum Lane Widths for the City of Edmonton":

- + Speed;
- + Available right of way;
- + Land use;
- + Street classification;
- + Travel mode prioritization, volumes and level of service;
- + Cross section (number, type, and width of all cross section elements in each travel direction, including median);
- + Collision history;
- + Parking utilization and turnover;
- + Curbside deliveries and loading;
- + Emergency Services;
- + Utility installations;
- + Snow clearing and storage requirements; and
- + Topography and curvature.

## TRAVELLED WAY (CONT.)

### 3.2

**Table 3.6A** Design Domain for Lane Widths (in m): Design Speed 50 km/h or Less

Parameter: Lane Widths <sup>1,2</sup>	Design Domain Recommended Range		City of Edmonton Target Value
	Recommended Lower Limit	Recommended Upper Limit	
<b>Standard Travel Curbside Lane (non-transit, non-truck route)<sup>3</sup></b>	3.25	3.75	3.25
<b>Standard Travel Lane (non-transit, non-truck route)</b>	3.00	3.50	3.00
<b>Transit Route Curbside Lane</b>	3.55	3.75	3.55
<b>Transit Route Lane</b>	3.30	3.50	3.30
<b>Truck Route Curbside Lane</b>	3.55	3.95	3.65
<b>Truck Route Lane</b>	3.30	3.70	3.40
<b>Parking Lane</b>	2.35	2.65	2.45 <sup>4</sup>

**Notes:**

1. Dimensions are for through and turning lanes. Turning lanes are typically at the lower end of the recommended ranges as these movements are completed at lower Operating Speeds.

2. Dimensions are measured to face of curb for curbside lanes.

3. For local streets, alleys, shared streets, and pedestrian only streets, a combined single drive lane with yield operation for both directions can be provided. This shared lane must be a minimum of 4.1 metres wide. For local streets, the minimum Travelled Way width shall be 8.0 m to accommodate required offsets for underground utilities and emergency response access, which may require parking restrictions. Service roads have a minimum Travelled Way width of 6.0 m due to the presence of an adjacent street. The designer must also consider the impacts of underground utilities, as well as winter design and operations when selecting Travelled Way widths.

4. Parking lanes for large trucks in industrial areas shall be 3.10 m to face of curb for collector and local roadways.

## TRAVELLED WAY (CONT.)

### 3.2

**Table 3.6B** Design Domain for Lane Widths (in m): Design Speed Over 50 km/h

Parameter: Lane Widths <sup>1,2</sup>	Design Domain Recommended Range		City of Edmonton Target Value
	Recommended Lower Limit	Recommended Upper Limit	
<b>Standard Travel Curbside Lane (non-transit, non-truck route)<sup>3</sup></b>	3.55	3.95	3.75
<b>Standard Travel Lane (non-transit, non-truck route)</b>	3.30	3.70	3.50
<b>Transit Route Curbside Lane</b>	3.65	3.95	3.75
<b>Transit Route Lane</b>	3.40	3.70	3.50
<b>Truck Route Curbside Lane</b>	3.65	3.95	3.95
<b>Truck Route Lane</b>	3.40	3.70	3.70

**Notes:**

1. Dimensions are for through and turning lanes. Turning lanes are typically at the lower end of the recommended ranges as these movements are completed at lower Operating Speeds.
2. Dimensions are measured to face of curb for curbside lanes.

### 3.2.3 Bicycle Facilities

Bikeway facilities range in types based on the degree to which people riding bicycles are separated from motor vehicle traffic and people walking and wheeling. The types of facilities and their level of separation are as follows:

- + On-Street Bike Lanes – are on-street facilities designed for the exclusive use of people cycling. Bike lanes are separate from travel lanes for motor vehicle traffic and from facilities for people walking. Bike lanes come in three basic forms: unprotected painted bike lanes, unprotected buffered painted bike lanes, and protected bike lanes (sometimes referred to as separated bike lanes or cycle tracks in some communities);
- + Off-Street Paths – are roadside facilities (i.e., off-street in the public realm) for the exclusive use of people cycling (i.e., bike paths) or for shared-

use by people cycling, walking and wheeling, and other active transportation modes (i.e., shared pathway); and

- + Shared Roadways & Local Street Bikeways – (sometimes referred to as a bicycle boulevard or neighbourhood greenway in some communities), are located on the street in space shared with motor vehicle traffic within the Travelled Way. The application of motor vehicle speed and volume management techniques can be an important, and in many cases a necessary, design component to create an operating environment that meets the needs of the design user group (i.e., “Interested but Concerned).

These facility types are further described in **Section 3.2.3.2** along with the recommended Design Domain for each facility type. More information and details can be found in Section 5.3 of the TAC GDG.



## TRAVELLED WAY *(CONT.)*

### 3.2

#### 3.2.3.1 Selection of Suitable Bikeways

It should be anticipated that people on bikes may ride on any street and that motor vehicle speed and volume are key considerations in identifying a suitable bikeway facility. Higher motor vehicle speeds require increased separation for the safety and comfort of people cycling, while higher motor vehicle volumes increase the number of potential conflicts. The type of conflicting traffic can also impact the suitable type of cycling route; streets with more trucks and buses may also warrant increased separation.

The following Bikeway Selection Framework is consistent with Canadian and international guidance.<sup>11</sup> Details of the design requirements for each bicycle facility is included in Section 3.2.3.2.

The selection framework can be used in numerous ways to select and evaluate bikeway facility types in the design process as follows:

- ✦ If a street has been selected for a bikeway, the framework can help identify candidate bikeway facilities for that street;
- ✦ If a bikeway facility (e.g., protected bike lane) has been selected, the framework can help identify candidate streets with suitable conditions for that facility type;

- ✦ If a bikeway facility has been selected for a street, the framework can help identify what the target motor vehicle speed should be on that street. This can be used to allocate traffic calming measures and enforcement resources; and
- ✦ For an existing bikeway facility, the framework can be used to identify if it remains suitable for prevailing conditions based on motor vehicle traffic speeds and volumes.

#### Curbside Activity and Access Management

Areas of high curbside activity include:

- ✦ High parking turnover or loading
- ✦ Frequent transit
- ✦ Congestion
- ✦ High number of turning conflicts (high number of intersections and driveways/accesses).

Streets with high curbside activity have higher rates of crossing and potential conflicts between users. In these areas uni-directional bike lanes or paths are more appropriate as the conflicts are more predictable. Bi-directional facilities should be avoided in areas of high curbside activity as users have challenges tracking people cycling approaching from two directions. This requires careful marking of conflict points at all intersections, driveways/accesses and separated traffic signal phasing at intersections which can create additional signal delay and requires separated turn lanes.

<sup>10</sup> Winters, M., Davidson, G., Kao, D., & Teschke, K. 2011. "Motivators and Deterrents of Bicycling: Comparing influences on Decisions to Ride". *Transportation*, 38, pp. 153-168.

<sup>11</sup> In addition to Figure 5.4.1 from the TAC GDG, for other examples, see: Ministry of Transportation Ontario (MTO). 2013. "Figure 3.3", *Ontario Traffic Manual. Book 18: Cycling Facilities.*; de Groot, R. editor (CROW). 2016. "Table 5-2: Selection plan for cycle facilities in the case of road sections in built-up areas," *Design Manual for Bicycle Traffic.* CROW.; Austroads. 2014. "Figure 2.2," *Cycling Aspects of Austroads Guides.* Publication AP-G88-14.; Troels Andersen, et al. 2012. Figure showing "cycling solutions in relations to motor traffic volume and speed", p. 53, *Collection of Cycling Concepts 2012.* Cycling Embassy of Denmark; National Association of City Transportation Officials (NACTO). 2017. Figure showing "Contextual Guidance for Selecting All Ages & Abilities Bikeways", *Designing for All Ages & Abilities - Contextual Guidance for High-Comfort Bicycle Facilities.*

## TRAVELLED WAY (CONT.)

### 3.2

Additional mitigations include increasing sight-lines between users, larger buffers between users and limiting movements (eg. right-out only) in and out of intersections.

#### Posted Speed and Traffic Volumes

Posted speed and traffic volumes have a significant impact on cyclist comfort. As the relative speed between cyclists and motor vehicles increases, the comfort and safety of people on bikes decreases. At lower speeds, it is generally acceptable for cyclists and motorists to share the same space, but as speeds increase, higher levels of protection and separation are required. At lower volumes, higher speeds may be acceptable before separation or protection is required, but the facility will not be all-ages and abilities unless both traffic volumes and speeds are low and the design clearly prioritizes people cycling. More information about this is provided in Section 3.2.3.2 **Local Street Bikeways**. At speeds over 50 km/hr separation and protection is required. Where traffic conditions are near posted speed and volume thresholds, measures such as traffic calming and/or diversion should be implemented to ensure that vehicle operations remain within the required threshold, or alternative active transportation infrastructure should be implemented to ensure safe and comfortable operations should those thresholds be exceeded in the future.

#### Pedestrian Volumes

Where higher pedestrian volumes are present, separation between pedestrians and cyclists should be considered. This includes where:

- + A high percentage of pedestrians (more than 20% of users) and total peak user volumes are greater than 33 persons/hr/m of path width; or
- + A low percentage of pedestrians (less than 20% of users) and total peak user volumes greater than 50 persons/hr/m of path width; or
- + There are greater than 1500 combined users/day

Where pedestrian counts or forecasted volumes are not available, land use plans can be used to identify areas where higher pedestrian activity may result in increased conflicts between people walking and people cycling. These may include pedestrian priority areas and areas with a high concentration of destinations and/or street fronting retail.

**Table 3.7** summarizes the range of speeds and volumes at which each *bikeway facility is most likely to be suitable* for the “Interested but Concerned” user group (see Section 3.1.3.2). The table is meant to be a starting point in selecting bikeway facilities for design. The street Posted Speed is used in this framework since it is generally known, but should not limit the designer from using engineering judgment to select a facility for a street in consideration for safety and accessibility

## TRAVELLED WAY (CONT.)

### 3.2

**Table 3.7** Framework for Consideration of Bikeway Facilities

Street Context				
Posted Speed	Max Motor Vehicle Volume (AADT)	Motor Vehicle Lanes	Key Operational Considerations	Bicycle Infrastructure Type
Any	Any	Any	Any of the following: - high curbside activity - frequent buses - motor vehicle congestion - turning conflicts	<b>Protected Bike Lane</b>
Up to 15 km/h	Less Relevant	No centerline, or single lane one-way	People walking share the travelled way	<b>Shared Street</b>
Up to 30 km/h	Up to 2000		Supports all ages and abilities when designed to ensure less than 50 motor vehicles per hour in peak direction (or up to 1000 vehicles per day)	<b>Local Street Bikeway</b>
Up to 40 km/h	Up to 1500			
Up to 50 km/h	1500 to 3000	Single lane each direction, or single lane one-way	Low curbside activity or low congestion pressure	<b>Painted or Buffered Bike Lane or Protected Bike Lane</b>
	3000 to 6000			<b>Buffered or Protected Bike Lane</b>
	Over 6000			<b>Protected Bike Lane</b>
	Any	Multiple lanes per direction		
Over 50 km/h	Up to 6000	Single lane each direction	Low curbside activity or low congestion pressure	<b>Protected Bike Lane or Reduce Roadway Speed</b>
		Multiple lanes per direction		<b>Protected Bike Lane or Reduce Roadway to Single Lane and Reduce Roadway Speed</b>
	Over 6000	Any	Any	<b>Protected Bike Lane (rigid barrier if 60 km/h or more) or Shared-Use Path</b>
High Speed (80 km/h or more) limited access roadways, natural corridors, utility corridors, or geographic edge conditions with limited conflicts		Any	High pedestrian volume (more than 33 per hour)	<b>Segregated shared pathway (i.e. with separate sidewalk and bike path) or Protected Bike Lane with rigid barrier</b>
			Low pedestrian volume	<b>Shared Pathway or Protected Bike Lane with rigid barrier</b>

## TRAVELLED WAY (CONT.)

### 3.2

#### 3.2.3.2 Bikeway Facility Design Domain

The following presents the recommended Design Domain for each bikeway facility type. More information and details can be found in Section 5.3 of the TAC GDG.

When selecting widths, the designer should consider impacts to the design user:

- ✦ Whenever possible, design widths that allow side-by-side riding should be selected. This allows for social riding and passing. Where passing is not possible, it may encourage people on bikes to use the driving lane or sidewalk to make passing maneuvers or avoid hazards
- ✦ When using narrower widths, shorter, or mountable curbs should be used to reduce the hazard of pedal strike and provide a place to exit the lane

#### Protected Bike Lane

**Protected Bike Lanes** are illustrated in **Figures 3.12** and 3.13. They are typically positioned directly next to a curb or on the curb side of a parking lane, and are separated from motor vehicle travel lanes by a vertical delineator appropriate to the speed and volume of the adjacent motor vehicle traffic. The defining element of this facility type is the horizontal and/or vertical protected bike lane delineator, which is designed to minimize or prevent encroachment on the bike lane by motor vehicles. A parking lane, where provided, may also function as a further buffer between people cycling and motor vehicle traffic as a complementary element beyond the protected bike lane delineator. Protected bike lanes may also be separated from motor vehicle travel lanes by grade separation at an elevation between the Travelled Way and sidewalk.

Other important considerations for protected bike lanes are traffic controls and markings to manage conflicts with other street users at intersections and driveway locations, queuing space for people riding bikes at intersections, and managing



Figure 3.13 Bidirectional Protected Bike Lane

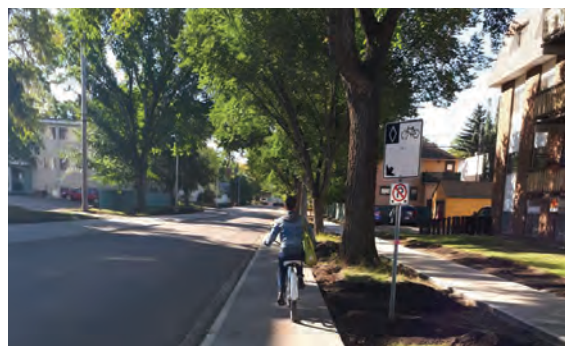

Figure 3.12 Unidirectional (Raised) Protected Bike Lane

access to vehicle parking spaces, loading zones, and bus stops.

In general, unidirectional protected bike lanes on each side of the street are preferred on two-way streets due to the design challenges with bidirectional protected bike lanes in this context. Bidirectional protected bike lanes on two-way streets require careful marking of conflict points at driveways/accesses using pavement markings and signs and separated traffic signal phasing at intersections.<sup>12</sup>

<sup>12</sup> The City is currently reviewing safety and operations of bi-directional bikeways on two way streets. Guidance may change pending outcome of the safety reviews.

## TRAVELLED WAY (CONT.)

### 3.2

On one-way streets, bidirectional protected bike lanes should be placed on the left side of the street for two reasons. First, bicycle and motor vehicle traffic move in the same direction where they are adjacent, reducing their relative travel speed. Second, users remain on the normally-anticipated side of the street, so that drivers making right turns do not face oncoming bicycle traffic, which is contrary to drivers' expectations. It should be noted that in this situation, drivers making left turns will need to be aware of cyclists travelling in the same direction on their left.

**Table 3.8** defines the Design Domain for protected bike lanes.

The recommended width of a protected bike lane is based on:

- + Accommodating passing and side-by-side riding where possible to accommodate social riding and different cycling speeds;
- + Accommodating single-file bicycle traffic plus separation between people traveling in opposite directions on bidirectional facilities; and
- + Accommodating higher volumes and speeds at the higher end of the recommended range and for district connections (>1500 bicycles/day).

When selecting widths on the lower end, the designer should consider the use of low or rolled curbs to provide a safe run out zone for cyclists. Lower limits should only be used in retrofit or constrained urban situations.

**Table 3.8 Design Domain: Protected Bike Lanes (in m)**

Parameter	Design Domain Recommended Range		Target
	Lower Limit	Upper Limit	
<b>Bike Lane Component<sup>1</sup></b>			
<b>Unidirectional Bike Lane (District Connector)</b>	2.1	3.0	2.5
<b>Unidirectional Bike Lane (Neighbourhood Route)</b>	1.8	2.5	2.1
<b>Bidirectional Bike Lane (District Connector)</b>	3.0	4.5	4.0
<b>Bidirectional Bike Lane (Neighbourhood Route)</b>	2.5	3.0	3.0
<b>Buffer Component<sup>2,3</sup></b>			
<b>Buffer Width, Bike/Street</b>	0.6	N/A	1.5
<b>Buffer Width, Bike/Walk</b>	0.3	N/A	1.0

**Notes:**

1. The width of the bike lane component is measured to/from the face of the curb and accommodates the horizontal operating envelope, horizontal offset to curbs, 0.25 m gutters, and considerations for all seasons maintenance. For gutters wider than 0.25 m, additional width is required due to the longitudinal hazard caused by the joint between the gutter and pavement.
2. Where the roadway speed exceeds 60 km/h, a separated bike path or shared pathway is preferred. If a bike lane is used, a rigid barrier is required and/or the delineator width should be increased to ensure the lane is outside of the clear zone.
3. Wider buffers are preferred when practical within available right-of-way.

## TRAVELLED WAY *(CONT.)*

### 3.2

In addition to the design requirements based on user needs and directionality, the width of protected bike lanes should also consider the width of maintenance equipment such as sweepers and snow plows. Protected bike lanes that are narrower than a clear width of 3.0 m may require the purchase and use of specialized sweeping, snow clearing, and snow removal equipment which may increase the cost of annual maintenance.

The recommended **minimum** width of the protected bike lane **buffer** ranges from 0.6 m to 1.0 m based on:

- + Typical dimensions of delineators;
- + Accommodating the opening of motor vehicle doors on the passenger side (minimum of 0.6 m width);
- + Accommodating the grade difference between a bike lane and a motor vehicle lane if the bike lane is raised (minimum of 1.0 m width);
- + Possibility to use the delineator for temporary snow storage for snow cleared from the bike lane; and
- + Accommodating typical widths of signs.

As part of protective delineator selection and design, the designer should consider the horizontal clearances as per Section 3.1.3.2 and incorporate additional width as required. Larger buffers can also be used to accommodate an ancillary zone or furnishings or plantings as long as the horizontal clearances are maintained.

Protected bike lane delineators, as illustrated in **Figure 3.14**, include green flexible bollards, parking stops, planter boxes, concrete barriers, raised bike lanes (see Figure 3.12), and raised medians. Protected bike lane delineators must use contrasting colours for high visibility, especially at night. For more information on these measures and the factors to consider for selection, refer to TAC GDG Section 5.7.5.

# TRAVELLED WAY (CONT.)

## 3.2

*Flexible Bollard*



*Parking Stop*



*Planter Box*



*Concrete Barrier*



*Raised Median*



*Raised Cycle Track*



**Figure 3.14** Protected Bike Lane Delineators

## TRAVELLED WAY *(CONT.)*

### 3.2

#### *Painted Bike Lane & Painted Buffered Bike Lane*

Painted bike lanes and buffered bike lanes are semi-exclusive travel lanes for people cycling. They are positioned adjacent to a curb and delineated from adjacent motor vehicle travel lanes by a solid white line. Where motor vehicle traffic may occupy a painted bike lane while turning or approaching a turn, a dashed white line is used and can be supplemented by green pavement markings.

To maintain the functionality of painted bike lanes, it is necessary to prevent blockage, especially lengthy or frequent blockages, by stationary motor vehicles. To keep the painted bike lane clear of these obstructions, regulation and/or signage can be used showing it is prohibited to park, stand, and/or stop in bike lanes. Ideally, the design will be self-explanatory, and the

use of street signage and pavement markings will highlight the appropriate use of the facility. To ensure compliance, signage should be combined with adequate Enforcement.

A **Painted Bike Lane** is illustrated in **Figure 3.15**.

A Painted Buffered Bike Lane is defined by additional white pavement markings running parallel to the Travelled Way that act as a longitudinal buffer to increase the separation between people cycling and adjacent motor vehicles, as illustrated in Figure 3.16. The buffer space is typically marked with a pavement marking such as hatched striping, and can decrease ambiguity as to the purpose of the bike lane and bike lane buffer (i.e., it is less likely to encourage inappropriate motor vehicle use as a travel lane).



**Figure 3.15** Painted Bike Lane



**Figure 3.16** Painted Buffered Bike Lane (Source: City of Calgary)



## TRAVELLED WAY (CONT.)

### 3.2

**Table 3.9** defines the Design Domain for the width of painted bike lanes and buffered bike lanes, with the rationale discussed following the table.

**Table 3.9 Design Domain: Painted Unidirectional Bike Lanes (in m)**

Parameter	Design Domain Recommended Range <sup>1</sup>		
	Lower Limit	Upper Limit	Target
<b>Bike Lane Component<sup>1</sup></b>			
<b>Unidirectional Bike Lane (District Connector)</b>	1.8	2.5	2.1
<b>Unidirectional Bike Lane (Neighbourhood Route)</b>	1.8	2.1	1.8
<b>Buffer Component<sup>2</sup></b>			
<b>Buffer Width, Bike/Street</b>	0.3	N/A	0.9

**Notes:**

1. The width of the bike lane component is measured from face of curb and accommodates the horizontal operating envelope, horizontal offset to curbs, 0.25 m gutters, and considerations for all seasons maintenance. For gutters wider than 0.25 m, additional width is required due to the longitudinal hazard caused by the joint between the gutter and pavement.
2. Wider buffers are preferred when practical within available right-of-way.

The recommended width of a painted bike lane of between 1.8 m and 2.1 m is based on:

- + Reasonable width for single-file movements;
- + Accommodation of basic passing movements;
- + Accommodating higher volumes of bicycle traffic (>1,500 bicycles/day) at the higher end of the recommended range; and
- + Accommodation for passing maneuvers for contra-flow bike lanes.

Where a total painted bike lane width greater than 2.1 m is available, it is recommended that a buffered bike lane be used instead.

If the total lane including the buffer is wider than 3.0 m, it may encourage motor vehicle traffic to use it inappropriately as a parking or travel lane. Where a total width greater than 2.5 m is available, it is recommended that a protected bike lane be considered.

## TRAVELLED WAY *(CONT.)*

### 3.2

#### *Shared Pathways & Bike Paths*

Bike paths and shared pathways are designations used to describe bike facilities that are not located directly on the Travelled Way, but separated from the vehicle traffic by a boulevard/Furnishing Zone, median, or buffer, or located within park space, open space, or a utility corridor. shared pathways should not be located immediately adjacent to a vehicle travel lane without a Buffer.

A shared pathway is an off-street facility that allows for two-way shared-use by people cycling and walking and wheeling as illustrated in Figure 3.17A.

If a shared pathway is configured to segregate people walking and cycling on separate path sections, as illustrated in Figure 3.17B, it is treated and designed as two facilities: a bike path and an adjacent sidewalk. Figure 3.17B shows the sidewalk facility elevated slightly above the shared pathway. An alternative

arrangement could include using a physical separation or a tactile delineator between the shared-use cycling path and the sidewalk. This configuration is preferable, especially when people walking make up an above average proportion of the users or when there are frequent amenities along one side of the path. This arrangement is also preferable for users with reduced Vision.

Segregation of shared pathway users should be considered where there is:

- ✦ A high percentage of pedestrians (more than 20% of users) and total peak user volumes greater than 33 persons per hour per metre of path width;
- ✦ A low percentage of pedestrians (less than 20% of users) and total peak user volumes greater than 50 persons per hour per metre of path width.

*(A) Shared Pathway*



*(B) Segregated Shared Pathway*



**Figure 3.17** shared pathways

## TRAVELLED WAY (CONT.)

### 3.2

Bike Paths are commonly located alongside a parallel sidewalk, as illustrated in Figure 3.18. As such, the bike path and sidewalk, as a pair, are similar to a shared pathway, but segregates the users by type



**Figure 3.18** Bike Paths (with adjacent sidewalk)

Bike Paths are commonly located alongside a parallel sidewalk, as illustrated in Figure 3.18. As such, the bike path and sidewalk, as a pair, are similar to a shared pathway, but segregates the users by type.

**Table 3.10 Design Domain: Shared Pathways and Bike Paths (in m)**

Parameter	Design Domain Recommended Range <sup>1</sup>		Target
	Lower Limit	Upper Limit	
<b>Bike Lane Component<sup>1</sup></b>			
<b>Unidirectional Bike Path (District Connector)</b>	2.1	3.0	2.5
<b>Unidirectional Bike Path (Neighbourhood Route)</b>	1.8	2.5	2.1
<b>Bidirectional Bike Path (District Connector)</b>	3.0	4.5	3.0
<b>Bidirectional Bike Path (Neighbourhood Route)</b>	2.5	3.0	3.0
<b>Shared Pathway</b>	3.0 <sup>2</sup>	6.0	3.0
<b>Buffer Component<sup>3</sup></b>			
<b>Buffer Width, Bike/Street</b>	0.6	N/A	1.5
<b>Buffer Width, Bike/Walk</b>	0.3	N/A	1.0

**Notes:**

1. Widths measured from edge of path to edge of path. If paths are located adjacent to a curb (i.e., curbline or monolithic path), an additional minimum 0.5 m width is required if the curbside activity is a travel lane (additional buffer for higher speed and/or volume streets) or 0.6 m for a parking lane.
2. The Design Domain for shared pathway recommended lower limit along an Industrial Local Street can be 2.5 m if the path is not a primary corridor within the larger bicycle network at the discretion of the City.
3. Wider buffers are preferred when practical within available right-of-way.

## TRAVELLED WAY *(CONT.)*

### 3.2

The recommended lower limit width of a shared pathway provides comfortable width for one person cycling in each direction and accommodates a scenario based on the operating envelope of a single person cycling (1.2 m) plus comfortable space (1.8 m) for two people walking abreast. This dimension also accommodates the operating envelope of one coasting inline skater in each direction. The recommended upper limit width is appropriate in areas with higher volumes of walking and cycling traffic where there is a need to accommodate passing maneuvers for cyclists and pedestrians simultaneously in both directions of travel.

The recommended width of a bike path depends on whether it is unidirectional or bidirectional and is consistent with the Design Domain for protected bike lanes.

#### *Local Street Bikeway*

A **Local Street Bikeway**, as illustrated in Figure 3.19, is a street where the Travelled Way is shared by people cycling and driving and provides a continuous corridor of suitable operating conditions for the design user group (i.e., “Interested but Concerned”), including limiting exposure to motor vehicle traffic and designing for low motor vehicle speeds. Often located on local streets, **local street bikeways** incorporate traffic calming measures to facilitate through access by bicycle traffic while inhibiting through access by motor vehicle traffic.

At intersections, such traffic calming measures can include diagonal diverters, bicycle-crossable medians, and neighbourhood traffic circles. Between intersections, traffic calming measures can include bicycle-crossable chicanes and speed humps. Design guidance for traffic calming measures is provided in Section 3.8 while additional resources are also available from a number of sources.

To reduce travel time for people cycling and facilitate maintenance of speed and momentum at minor street intersections, stop signs should be oriented to control the cross street rather than the **local street bikeway**. At major street intersections, bicycle signals with bicycle actuation should be provided. **To mitigate potential concerns with speeding and shortcutting that may occur as a result, additional traffic calming or diversion may be required.**

## TRAVELLED WAY *(CONT.)*

### 3.2

Signage and pavement markings should be used to identify the local street bikeway and prepare motorists to encounter traffic calming treatments. Shared-use lane markings (“sharrows”) may be used in accordance with the TAC Bikeway Traffic Control Guidelines for Canada. Care should be utilized to not rely solely on pavement markings as they may not be visible in winter conditions and may not support the conditions required to ensure a suitable facility for users of all ages and abilities.

A local street bikeway incorporates design elements as need to ensure traffic speeds are 30 km/h or less, volumes are low (under 1,000 vpd), and the design of the facility clearly suggests that people cycling are prioritized, most people will feel safe and comfortable cycling in a shared facility. Existing examples of “Shared Roadway” treatments relying primarily on shared-use lane markings (“sharrows”) and signage may not be suitable for users of all ages and abilities.



**Figure 3.19** Local Street Bikeway

The Design Domain for the width for local street bikeways are based on the Design Domain dimensions for general purpose travel lanes and parking lanes in Sections 3.2.2.

<sup>13</sup> Refer to: National Association of City Transportation Officials (NACTO). 2012. Urban Bikeway Design Guide, Second Edition; Transportation Association of Canada (TAC). 1998. Canadian Guide to Neighbourhood Traffic Calming; Transportation Association of Canada (TAC). 2012. Bikeway Traffic Control Guidelines for Canada, Second Edition; and Vélo Québec. 2010. Planning and Design for Pedestrians and Cyclists: A Technical Guide. Montreal: Vélo Québec Association.

## TRAVELLED WAY *(CONT.)*

### 3.2

#### 3.2.3.3 Additional Bicycle Design Considerations/Guidance

##### Lighting

Lighting is an essential component of bicycle transportation infrastructure. The most important areas for lighting are intersections, which need to be illuminated to allow a person cycling enough time to see the intersection and take appropriate action in advance of the crossing. Intersection lighting also allows the people cycling to be seen, and to see others, while crossing the intersection. Additional locations where lighting is important are bridges, under and over passes, crossings, tunnels, and viaducts. Where the bikeway facility is separated from the Travelled Way by more than 5 m, lighting design should follow the Volume 6 of the City of Edmonton’s Design and Construction Standards. Lighting may also be needed wherever there is bikeway facility signage, particularly warning signs.

The effects of incidental lighting on a shared pathway need to be considered. The most common example of incidental lighting is where a path parallels a street. Headlights of oncoming vehicles can shine directly into the eyes of people cycling causing momentary blindness. Similarly, people cycling on-street could be hidden by the headlights of vehicles from behind. This could be hazardous to people cycling on a curving path or in the face of oncoming bicycle traffic. In these cases, low level path lighting is recommended. Refer to Volume 6 of the City of Edmonton’s Design and Construction Standards for appropriate lighting levels.

##### Integration with Transit

Where painted bike lanes, buffered bike lanes, and protected bike lanes are adjacent to the curb line on a street that has transit stops, there will be potential conflicts with transit vehicles stopping for embarking or disembarking passengers. There are two basic approaches: Transit Stop Mixing and Transit Stop Island.

The preferred and recommended approach is the Transit Stop Island, where an island is provided for transit passenger waiting/boarding/alighting and the bike lane is located between the Pedestrian Trough Zone and the transit stop. This removes interaction between transit vehicles and people cycling.

Figure 3.20 illustrates a transit stop island with a bicycle bypass which allows people cycling to pass stopped buses on the right side of the bus, between the transit stop island and the sidewalk, and prevents conflicts with buses pulling to the curb. The transit stop island can be used with painted bike lanes, buffered bike lanes, and protected bike lanes. The bike lane can be raised or at street-level. If the bike lane is located at street level, curb ramps will be required to provide an accessible connection to the transit island for pedestrians.



Figure 3.20 Bicycle Bypass at Transit Stop – Transit Stop Island

<sup>14</sup> Vélo Québec. 2010. Planning and Design for Pedestrians and Cyclists: A Technical Guide. Montreal: Vélo Québec Association

## TRAVELLED WAY *(CONT.)*

### 3.2

Conflicts between people cycling and people walking and wheeling may increase around transit stop islands compared to conventional bus stop designs. However, this tendency can be mitigated by providing generous transit islands, clearly marking the bikeway crossing with pavement treatments and signage, and improving sightlines near the transit stop. Railings that direct people walking and wheeling to a single crossing location may be appropriate where conflicts cannot be effectively mitigated. Additionally, a raised crossing from the transit island to the sidewalk provides people walking and wheeling a consistent crossing grade and slows the speed of approaching bicycle traffic. The size of the raised crossing will depend on pedestrian and cyclist volumes. For more guidance on bike infrastructure integration with transit stops, refer to TAC GDG Section 5.7.4.

In constrained locations with protected bike lanes, providing a transit stop island may not be possible. In these instances, as illustrated in Figure 3.21, the protected bike lane can be raised to sidewalk level and transit passengers board and alight the transit vehicle from the protected bike lane. The raised protected bike lane allows for level-boarding for transit passengers. Pavement markings and signs are included to confirm the right of way of people walking and wheeling and the need for people cycling to stop during transit boarding/ alighting operations.



**Figure 3.21** Raised Protected Bike Lane at Transit Stop for Constrained Locations



**Figure 3.21** Raised Protected Bike Lane at Transit Stop for Constrained Locations

Figure 3.22 illustrates the transit stop mixing approach that allows the transit vehicle to cross a dashed painted bike lane line to access the curbside transit stop. The use of this approach should be limited and is typically only applied in constrained situations and when bus volumes are 4 or fewer per hour.



**Figure 3.22** Painted Bike Lane at Curbside Transit Stop

## TRAVELLED WAY *(CONT.)*

### 3.2

#### 3.2.4 Pavement Markings & Signs for Bicycles at Mid-Block Locations

The latest pavement marking guidelines for the City of Edmonton can be found in the City’s Design and Construction Standards Volume 8: Pavement Marking. This document should be referenced for all standard longitudinal markings (lane lines, pavement edge lines, guidelines, etc.), lateral markings (crosswalks, stop bars), merging/diverging markings, and pavement symbols.

For signage and pavement markings, refer to the latest edition of the MUTCD-C.

For additional information on the application of MUTCD-C bicycle-specific pavement markings and signage, see the TAC Bikeway Traffic Control Guidelines for Canada

Some general principles associated with these guidelines are:

- ✦ An emphasis on uniformity of design and application to avoid confusion;
- ✦ Clear identification for all street users making it particularly useful to visitors and those using a facility for the first time; and
- ✦ In all cases, proposed sign and pavement marking designs for bicycle routes or paths must be confirmed as enforceable under the relevant traffic regulations.

The MUTCD-C and TAC Bikeway Traffic Controls Guidelines for Canada includes some pavement marking and signage guidance for bicycle facilities that are not currently in Volume 8 of the City of Edmonton’s Design and Construction Standards. The following should be used until Volume 8 is updated.

For pavement markings associated with bicycle facilities at intersections, refer to Section 3.6.6 and 3.6.9.

#### Reserved Lane Marking for Bicycle Lanes

A diamond reserved lane pavement marking with a bicycle symbol is marked for along each block and at conflict locations for painted, buffered, and protected bike lanes.



**Figure 3.23** Reserved Lane Pavement Markings for Bicycle Lanes

Bicycle lane lines delineate the edge of a travelled lane dedicated for bicycle use, where travel is permitted in the same direction on both sides of the line. Bicycle lane lines direct motor vehicles and bicycle traffic into the appropriate lanes, and provide for efficient and safe use of the road. Bicycle lane lines are solid, white in color, with a width of 100 mm. Where motor vehicles are permitted to move into or cross the bicycle lane to perform a turning movement, a 15 m long minimum broken line is used, with a 1.0 m segment and a 1.0 m gap.



## TRAVELLED WAY *(CONT.)*

### 3.2

#### *Contraflow Bicycle Lane Line*

The directional dividing line for full-time contraflow painted bike lanes is a solid yellow line (200 mm).



*Figure 3.24 shared pathways*

#### *Bicycle Pavement Markings at Mid-Block Conflict Zones*

At driveways and accesses, dashed bike lane lines are used and can be supplemented with green pavement markings (solid or dashed). The green pavement markings increase visibility of the conflict zones between motor vehicle and bicycle traffic at these locations (and through intersections). Green pavement markings should be used at all mid-block conflict zone locations except at locations with very low motor vehicle volumes (e.g., driveway to a single family home).



*Figure 3.24 Contraflow Bicycle Lane Line*

## TRAVELLED WAY (CONT.)

### 3.2

#### 3.2.5 Centre Treatments

This section provides guidance on elements of the Travelled Way that are located in the centre of the Travelled Way with a focus on medians and two-way left turn lanes for urban streets.

A median is the portion of the road which physically separates the travel lanes of traffic travelling in opposing directions. Median width is the lateral dimension measured between the face of curbs on either side of the median (or edge of shoulder for expressway/freeway medians).

*Types of medians and two-way left turn lanes are illustrated in **Table 3.11**. Medians range from raised concrete/landscaped to barriers to depressed landscaped areas to painted medians. Streets with higher speeds or volumes typically use barrier-style or depressed medians. Medians along streets in urban areas are typically raised concrete or landscaped medians and, in some cases, are a textured surface. Textured surfaces may require additional life cycle maintenance and repair. Medians can also be used for low impact drainage (LID). Refer to the City's LID Guidelines for more information on LID.*

Where medians are intended for use as a refuge area for walking, wheeling, or cycling across wide streets (over 3 lanes), the median can be raised with curb ramps for Universal Design and should be sized to accommodate bicycles with trailers and mobility aids. If pedestrian actuated push buttons are used for the signals, additional push buttons mounted to poles within the median will be required.

Raised medians are also used as a delineator for protected bike lanes and more information can be found in Section 3.2.3.2.

**Table 3.11: Median Types**



*Rural freeway/ expressway median*

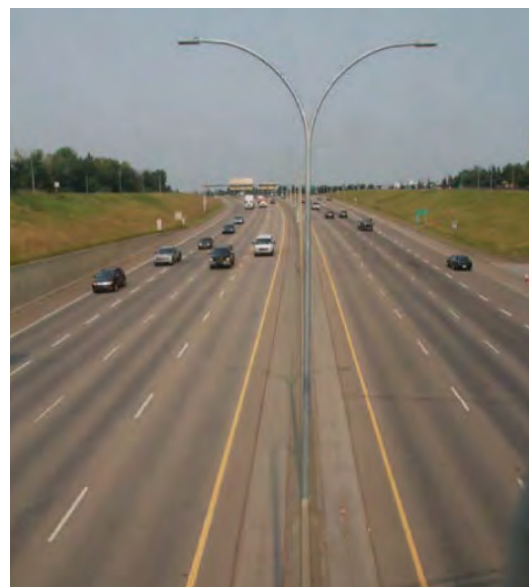

*Urban freeway/ expressway narrow median*

## TRAVELLED WAY *(CONT.)*

### 3.2

Table 3.11: Median Types *(cont.)*

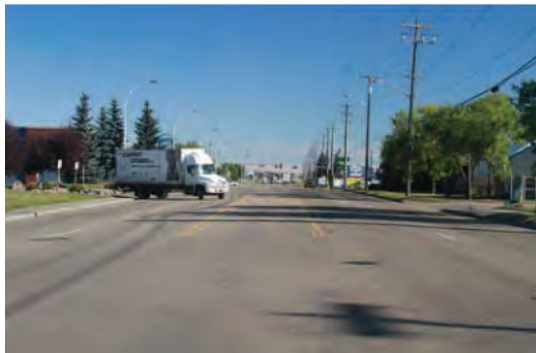

*Two-way or shared left-turn centre lane (Typically only used in industrial area arterial streets)*



*Painted/Flush median*



*Textured (and flush) median*



*Raised median*



*Refuge median*

## TRAVELLED WAY *(CONT.)*

### 3.2

#### 3.2.5.1 Freeway Medians

Median widths for non-urban freeways range from 13 m to 30 m. For consistency with Provincial standards for freeways, a median width of 30.6 m (measured between the edges of the innermost ultimate travel lane in each direction) is recommended for depressed medians in non-urban settings, while a median width of 13.4 m is recommended for depressed medians in urban settings. For additional information regarding rural freeway design, refer to the Alberta Transportation Highway Geometric Design Guide.

Urban freeways generally have medians that are flush or a raised island with a median barrier. Median dimensions depend on shoulder widths, barrier type, and the need for provision of structure piers.

Medians are much narrower in constrained urban corridors. Minimum median width should be 3.0 m, plus the width of the selected barrier, plus allowances for such factors such as barrier deflection on impact, and provision for barrier mounted illumination poles, overhead sign footings, and bridge piers. Design Domain values for freeway medians are provided in [Table 3.12](#).

#### 3.2.5.2 Arterial Medians

Medians on a divided urban street serve a variety of important purposes related to safety, traffic operations, access control, and aesthetics including:

- ✦ Physical separation of opposing traffic flows;
- ✦ Storage area for left-turning vehicles out of the path of the through traffic stream;
- ✦ Provision of pedestrian and bicycle refuge space;
- ✦ Control of access by restricting left- turns and U-turns to specific median openings;

- ✦ Provision of physical space for the effective placement of signage, traffic control devices and bridge piers;
- ✦ Provision of human scale and visual character to the street; and
- ✦ Provision of space for landscaping and streetscaping treatments to enhance street aesthetics, designed in accordance with Volume 5: Landscape Design and Construction Standards.

While medians in urban areas may be either raised or flush, they are normally raised using straight face curb. They can include median tips that protect the refuge area and slow left turning motor vehicle traffic, decreasing the speed of left turns across the path of people walking, wheeling, and cycling. Recommended median dimensions are provided in [Table 3.12](#) for different types of medians based on street classification.

Additional median width may be required to accommodate left turn bays, auxiliary left turn lanes, higher volumes of turning truck or transit traffic, illumination poles, bridge piers, or traffic control devices. Refer to Appendix C and Chapter 3 of this document, as well as TAC GDG Section 4.5.3 for guidance on these specific accommodations.

In general, medians should be included on streets:

- ✦ With Posted Speeds of 60 km/h or more; or
- ✦ With more than 3 lanes in order to provide a refuge area for people walking, wheeling, and cycling to complete two stage crossings at intersections and/or mid-block locations, particularly where the crossings are unsignalized.

## TRAVELLED WAY (CONT.)

### 3.2

**Table 3.12** Design Domain: Median Widths (in metres)

Parameter: Median Width	Design Domain Recommended Range <sup>1</sup>	
	Recommended Lower Limit	Recommended Upper Limit
<b>Freeway Median, Depressed</b>	13.0	30.0
<b>Freeway Median, Raised</b>	5.5	N/A
<b>Non-Freeway, No Left Turn Bay<sup>1,2,3</sup></b>	1.2 <sup>3</sup>	N/A
<b>Non-Freeway, With Left Turn Bay</b>	4.5	N/A
<b>Non-Freeway, Walking/Cycling Refuge<sup>1,3</sup></b>	3.0	N/A

**Notes:**

1. Non-freeway median widths are measured from face of curb to face of curb.
2. Minimum median width of 1.8 m is required for a raised landscaped median.
3. Walking/Wheeling/Cycling Refuge areas should have a minimum width of 3.0 m and area of 10 m<sup>2</sup> to provide sufficient room for all users. Refuge area medians with a median tip should be provided when a street crossing of more than 2 lanes per direction is required and the crosswalk/crossride passes through the median at street level.

### 3.2.6 Horizontal Alignment

Horizontal alignment is the configuration of the street as seen in plan view (e.g., aerial) and generally consists of tangent sections and circular curves. In developing the alignment, the designer must establish the proper relationship between the curvature of the street and a set of horizontal alignment controls with the objective of providing for safe continuous operation at the desired Operating Speed under the general conditions for that street.

#### 3.2.6.1 Design Domain Controls

The horizontal alignment is a relatively permanent feature of a street and is generally difficult and expensive to modify after its construction. It is thus critical that the designer be aware of and account for a number of key factors which can have a significant influence in defining the boundaries of the Design Domain for the various elements of horizontal alignment. The following items have specific relevance to horizontal alignment design:

- + User expectation;
- + Design Speed;
- + Topography, available property, and environmental features;
- + Climatic conditions;
- + Adjacent land use;
- + Traffic volume and vehicle mix; and
- + Major utility location.

For more context on these Design Domain controls, refer to Appendix C and TAC GDG Section 3.2.1.2.

## TRAVELLED WAY *(CONT.)*

### 3.2

#### 3.2.6.2 Design Elements

The following horizontal alignment design elements are discussed in this section:

- + Circular curves;
- + Spiral curves; and
- + Superelevation.

##### *Circular Curves*

A circular curve, or simple curve, is one with a constant radius. For more information on the inter-relationship between human factors considerations, speed, maximum superelevation, lateral friction, minimum radius, and stopping sight distance, refer to TAC GDG Section 3.2.2. Minimum curve radii in the Edmonton context can be found below and in Appendix C.

##### *Spiral Curves*

A spiral curve is a curve with a constantly varying radius. The purpose of a spiral curve is to provide smooth transition and a natural driving path between a tangent and a circular curve. Spiral curves are typically only applied to streets with Design Speeds of 70 km/h and higher, and where superelevation of the circular curves is desirable. For information on how to design spiral curves, refer to TAC GDG Section 3.2.3.

##### *Superelevation*

As a vehicle travels around a circular curve at a constant speed it experiences radial acceleration which acts towards the centre of the circle. The centripetal force providing this radial acceleration is the lateral friction between the vehicle tires and the Travelled Way surface. If the Travelled Way is superelevated, the lateral friction is supplemented by a component of the force of gravity, due to the weight of the vehicle. For technical information on how to properly design/develop superelevation, refer to TAC GDG Sections 3.2.2 and 3.2.4.

For local and collector street in Edmonton, superelevation is not used. The minimum horizontal curves for local and collector streets are 90 m and 120 to 130 m, respectively. More details are provided in Appendix C.

For arterial streets, a maximum superelevation of 0.06 m/m can be used. See TAC GDG Section 3.2.4 for more information regarding the design of horizontal curves on arterial streets, freeways, and expressways.

## TRAVELLED WAY (CONT.)

### 3.2

#### 3.2.6.3 Horizontal Alignment: Bicycle Facilities

##### Minimum Radii

The minimum radius for a circular curve is a function of bicycle speed, superelevation, and coefficient of friction. For many on-street bicycle facilities, the horizontal alignment will match the horizontal alignment of motor vehicle travel lanes within the Travelled Way.

The absolute minimum radius for bicycle facilities is 5.0 m, below which the operating speed reduces to less than 12 km/h which is the speed where stability is significantly impacted. Table 3.13 shows the minimum design radius for superelevations at 0.02 m/m and 0.05 m/m. Where curve radii are less than those in the table, or superelevation is unavailable, warning signs should be placed in advance of the curve in accordance with MUTCD-C Section A.3.2.1. Superelevation is typically used for off-street paths or trails (shared-use or bike paths). The use of curve radii lower than those in this table should be avoided on major bike routes.

**Table 3.13** Minimum Radii for Paved Bikeways  
(Source: TAC GDG Table 5.5.2)

Design Speed (km/h)	Coefficient of Lateral Friction	Minimum Radius for Design (m)	
		e = 0.02 m/m	e = 0.05 m/m
20	0.30	10	9
25	0.30	15	14
30	0.28	24	21
35	0.27	33	30
40	0.25	47	42
45	0.23	64	57
50	0.22	82	73

##### Lateral Clearance

Lateral clearance to obstructions on the inside of horizontal curves is based on the need to provide sufficient sight distance to riders who notice an obstacle on their intended path of travel and need to stop. The line of sight to the object is taken to be the corner of the visual obstruction, and the stopping distance is measured along the intended path, which is taken to be the inside edge of the inner lane. Refer to TAC GDG Table 5.5.3 for the lateral clearance for a range of radii and stopping sight distances.

#### 3.2.7 Vertical Alignment

Vertical alignment consists of straight line grades (tangents or gradients) and the vertical curves used to connect them. There are two types of vertical curves, crest curves which occur on hills, and sag curves which occur in valleys. In general, the design of these curves is based on visibility to provide a safe stopping sight distance or comfort criteria and a parabolic function is used to define them.

##### 3.2.7.1 Design Elements

The following sections discuss, at a high level, the basic design elements of vertical alignment: grades, maximum gradients, and vertical curves.

##### Grades

The grade along a street is expressed as a percentage; that is the rise or fall in metres over a horizontal length of 100 m. Grades are positive if rising in the direction of increasing chainage and negative if falling in the direction of increasing chainage.

## TRAVELLED WAY (CONT.)

### 3.2

It is generally accepted that passenger cars readily negotiate grades as steep as 4 to 5% without appreciable loss of speed. On level grades, truck speeds approximate passenger car speeds. On down grades, truck speeds are about 5% higher than on level terrain. In some cases, on long downhill grades, trucking companies mandate slower speeds, to help prevent runaway trucks. On up-grades, there is a large variance in truck speeds depending on the severity and the length of grade as well as the mass/power ratio of the vehicle. For more information, refer to TAC GDG Section 3.3.2.

#### Gradients

Although the relationship between Design Speeds and maximum grade is relatively subjective, **Table 3.14** provides the generally accepted gradient ranges in Edmonton. The minimum longitudinal gradient must be provided on all streets to ensure adequate drainage.

**Table 3.14** Design Domain: Gradients (in %)

Parameter: Gradient	Design Domain Recommended Range		Target Value <sup>3</sup>
	Lower Limit	Upper Limit	
<b>Local &amp; Collector</b>	0.6%	8.0% <sup>1</sup>	6.0%
<b>Arterial</b>	0.6%	6.0% <sup>1</sup>	4.0%
<b>Freeway/ Expressway</b>	0.6%	5.0% <sup>2</sup>	4.0%

#### Notes:

1. Maximum grades of up to 12% may be utilized in exceptional circumstances where necessary due to Topography.

2. Higher maximum grades may be necessary in exceptional circumstances due to topography. Design consideration should be given to truck deceleration/ acceleration where grades in excess of 5.0% are used on high speed roads.

3. Maximum grades of 4.0% are recommended for Arterials and other major transportation facilities that are planned to include significant transit and/or goods movement wherever feasible.

<sup>15</sup> TAC. 2014. *Manual of Uniform Traffic Control Devices for Canada*. Ottawa: Transportation Association of Canada.

#### Vertical Curves

The function of a vertical curve is to provide a smooth transition between adjacent grades. The form of curve used for vertical curves is a skewed parabola, positioned so that basic measurements can be made horizontally and vertically. Curves are described as crest or sag depending on their orientation.

#### Crest Vertical Curves

Crest vertical curves have to be flat enough to provide the required sight distances. The most common sight distances that are considered in the design of vertical curves are:

- + Stopping sight distance;
- + Passing sight distance;
- + Decision sight distance; and
- + Non-striping sight distance.<sup>15</sup>

For design guidance on crest vertical curves, refer to TAC Section 3.3.3.2

#### Sag Vertical Curves

To provide adequate stopping sight distance on a sag vertical curve, where good street lighting does not prevail, the sag curve must be sufficiently flat for a vehicle's headlight beams to illuminate the road ahead at least for the minimum stopping sight distance. Where good street lighting does prevail, comfort becomes the criterion that limits values. For design guidance on sag vertical curves, refer to TAC GDG Section 3.3.3.4



## TRAVELLED WAY (CONT.)

### 3.2

#### 3.2.7.1 Design Elements (cont.)

Within Edmonton, vertical curves are required for all street profiles demonstrating an algebraic grade difference greater than:

- + Arterial: 1.0%
- + Collector: 1.5%
- + Local: 1.5%
- + Alleys: 2.0%

Successive short tangent lengths of various grades are not an acceptable design to eliminate vertical curves.

For additional vertical curve Design Domain application guidance and other design considerations, including drainage, snow, and intersections and driveways, refer to TAC GDG Section 3.3.5.

#### Vertical Clearance

A minimum vertical clearance of 5.4 m is required, measured from the highest point of the Travelled Way on the cross section to lowest point of the underside of the structure above.

#### 3.2.7.2 Vertical Alignment: Bicycle & Walking and Wheeling Facilities

##### Grade

The recommended range of gradients for bicycle and walking facilities is provided in Table 3.15. When setting grades, the designer should be cognizant that long, steep grades are a deterrent to cycling and walking.

The impacts of different grades on the operation of bike facilities are shown in Table 3.16. Recommended grades for people walking and wheeling are provided in Section 3.5.7.

**Table 3.15** Design Domain: Cycle and Walking Gradients (in %)

Parameter: Gradient	Design Domain Recommended Range	
	Recommended Lower Limit	Recommended Upper Limit
<b>Dedicated Cycle Facility</b>	0.6% <sup>1</sup>	6.0%
<b>Walking and Wheeling Facility (SUP, sidewalk, walking trail)</b>	0.6%	5.0% <sup>1</sup>

**Note:**

1. Minimum gradient may be reduced to 0.0% provided adequate cross slope and lateral slope is provided. Care should be given in designs where slopes are reduced.

**Table 3.16** Grade Impacts for People Cycling

Grade	Impacts
< 4%	Ideal grade for cycling Uphill speed is 10 km/h Downhill coasting speeds can reach 25 km/h
4% - 6%	Downhill coasting speeds can reach 40 km/h Desirable to have a relatively flat area (3% or less) every 100 m to allow people cycling to rest for uphill
6% - 8%	Not recommended Considered steep Should be paved Will reduce uphill speeds Downhill coasting speeds can reach 60 km/h Higher design speeds should be used Warning signs should be posted in accordance with MUTCD-C Section A4.4.3

Grades and length of slope for in-line skaters are found in the Section 3.3.1 of the TAC In-line Skating Review.

## TRAVELLED WAY (CONT.)

### 3.2

#### *Crest Curves and Sag Curves*

The algebraic difference in grade for vertical curves of shared pathways is 6%. Refer to TAC GDG Section 5.5.4.

#### *Vertical Clearance*

The recommended minimum vertical clearance for a bikeway is 3.6 m, measured from the highest point on the bikeway riding surface to the lowest point on the underside of the structure/foilage above the bikeway. This accommodates most small service vehicles and provides a comfortable buffer in addition to the 2.5 m vertical operating envelope.

#### *Cross Slope: Bicycle, Walking and Wheeling facilities*

Bike paths / shared pathways may be crowned or have a constant cross slope while on-street bicycle facilities typically use a constant cross slope. Where the offstreet path operation is two-way, a crowned section may be preferable for drainage and to maintain the cross fall to the right for people cycling in both directions.

Cross slope for a concrete-surfaced bicycle facility is recommended to be 2.0%. For asphalt-surfaced bicycle facilities, a cross slope of 2% to 3% is recommended.

#### *3.2.8 Curb & Gutter, Catch Basin & Utility Cover*

##### *3.2.8.1 Curb & Gutter*

Curbs are raised or vertical elements, located adjacent to a travel lane, parking lane, painted bike lane, or protected bike lane. They may be employed with all types of streets for any or all of the following reasons:

- + Drainage control;
- + Delineation of the pavement edge, cycling facilities, or walking facilities to improve safety;
- + Right of way reduction with the elimination of open ditch drainage;
- + Reduction in maintenance operations;
- + Access control or provision; and
- + Aesthetics.

Concrete gutters are typically used to facilitate longitudinal drainage along urban streets. They are often cast integrally with curbs. The width of a gutter should be excluded from the width needed for onstreet bicycle facilities.

There are three general types of curb: straight face, mountable, and roll face.

## TRAVELLED WAY *(CONT.)*

### 3.2

#### *Straight Face Curb*

Straight face curb is near vertical, with a typical height of 150 mm, and is intended primarily to control drainage and access. Straight face curb is generally not used on urban freeways and is considered undesirable on expressways and arterials with Design Speeds in excess of 70 km/h.



*Figure 3.26 Straight Face Curb*

#### *Mountable Curb*

Mountable curb is considered to be mountable under emergency conditions or very slow moving conditions. Its face slope ranges from short (100 mm or less) and nearly vertical to a slope of 0.250 m/m to 0.625 m/m with a maximum vertical height of 125 mm. Mountable curbs are often used on urban freeways, expressways, and on high speed arterials (Design Speed over 70 km/h). Mountable curbs are also used for mountable aprons on roundabouts or corner radii in street oriented contexts where corner radius is minimized but truck access is still required, or along bike routes where emergency access is necessary. Mountable curbs used for truck aprons will require multiple curb ramps to provide Universal Design access.



*Figure 3.27 Mountable Curb*

## TRAVELLED WAY *(CONT.)*

### 3.2

#### Roll Face Curb

A roll face curb contains a relatively flat sloping face (0.10 m/m to 0.25 m/m) to permit vehicles to cross over it easily. Roll face curbs are often used in residential neighbourhoods to facilitate access to driveways, or in constrained turning movement locations to accommodate large vehicles. Designers should consider additional improvements and design within the Furnishing Zone and/or Ancillary Zone to ensure the transition from the Furnishing Zone/Ancillary Zone/Pedestrian Through Zone to the Travelled Way is clear for people with visual impairments.



**Figure 3.28** Roll Face Curb

For more design guidance on these three curb types, refer to TAC GDG Section 4.7.2.

#### Mountable Curb

Drainage grates, catch basins, and utility covers are potential hazards for people cycling because they tend to be slippery when wet, not flush with the Travelled Way or bikeway surface, a prime location for the formation of potholes, and a potential trap for bicycle wheels. While this can be mitigated to some extent through the use of appropriate frames and covers including the City of Edmonton’s design (see **Figure 3.29**, below), wherever possible, catch basins and utility covers should not be located within a bikeway.



**Figure 3.29** - Example of bicycle-friendly catch basin design

## TRAVELLED WAY *(CONT.)*

### 3.2

#### 3.2.8.2 Catch Basin & Utility Covers *(cont.)*

Catch basins should never be located within a curb ramp, curb ramp flare, on corners with a radius less than 6.0 m, or other locations that are pedestrian crossings. This supports Universal Design principles for walking and limits pooling of rain or snowmelt in the crosswalk, thereby improving safety and accessibility.

Manholes and utility covers should not be placed within sidewalks as they pose a slip and trip hazard.

For best practices on urban storm drainage, LID treatments, and LID best management practices (BMP), refer to TAC GDG Section 4.8.3. Edmonton Design and Construction Standards for drainage infrastructure are provided in Volume 3.

#### 3.2.9 Road Structural Design

##### 3.2.9.1 Submission Requirements

For greenfield design, the first submission of engineering drawings shall be accompanied by a geotechnical report complete with borehole logs. The report shall specify the structures of the street required and all assumptions used in the structure design, including California Bearing Ratio (CBR) values, design traffic loading, and the pavement design life. Similarly, consideration should be provided by the geotechnical report to the pavement structure associated with the construction of Shared-Use Paths or Top-of-Bank Trails.

For rehabilitation projects, geotechnical investigations necessary to inform pavement design shall form part of the preliminary design.

##### 3.2.9.2 Construction Specifications

Chapter 2 (Construction Specifications) provides the construction specifications associated with road structural design and construction.

## PUBLIC REALM

### 3.3

In urban areas, the roadside is referred to as the public realm, or the public space along a street where people conduct their business and interact with each other. The public realm is comprised of the Furnishing Zone, Pedestrian Through Zone (or Clear Sidewalk), and Frontage Zone. In instances where the Ancillary Zone is utilized for patios or parklets, this zone too could be considered part of the public realm. Design requirements and illustrations for these zones are provided in the sections that follow.



**Figure 3.30** Sample of Public Realm Zones in an Urban Context

#### 3.3.1 Ancillary Zone

##### 3.3.1.1 Locational Requirements

Located between the Travelled Way and the Furnishing Zone, the Ancillary Zone provides a flexible space that can accommodate a number of different uses along a street in an urban area to reflect the unique requirements of the street users and adjacent lands. Ancillary Zones provide an enhanced buffer for people walking and wheeling from moving motor vehicles. They also allow for the flexible allocation of this space to active uses (e.g., parklets) that are critical to streets being places for people. Ancillary Zones are different from shoulders, in that they provide a specific role in supporting the public realm.

Ancillary Zones are typically provided in street oriented contexts and can be provided along streets of all functional classifications. The Ancillary Zone is not typically provided on streets with Design Speeds of 60 km/h or more and are typically not provided in nonstreet oriented contexts.

When on-street protected bike lanes are provided on a street, the Ancillary Zone uses are located between the bike lane and the rest of the Travelled Way. This, in effect, splits the Travelled Way on either side of the Ancillary Zone with general purpose motor vehicle travel lanes on one side and bicycle lanes on the other. For guidance on protected bike lanes and the delineator requirements associated with separating the lanes from the Ancillary Zone, see Section 3.2.3.2.

## PUBLIC REALM (CONT.)

### 3.3

#### 3.3.1.2 Possible Ancillary Zone Design Elements & Design Requirements

Elements and uses of the Ancillary Zone include parking for motor vehicles and bicycles, loading zones for deliveries, curb extensions, parklets or patios, and transit platforms. The width of the Ancillary Zone may need to be increased, by extending into the Furnishing Zone, to accommodate accessible parking for those specific stalls, where there are transit timing points, or where large vehicle loading activities regularly occur. The Ancillary Zone may also be used for snow storage.

Based on the possible design elements presented in the remainder of this section, Table 3.17 summarizes the Design Domain for the Ancillary Zone. Selecting a value closer to the recommended lower limit is more suitable for lower speed environments such as local streets or in highly constrained locations. On local streets where the Travelled Way is as narrow as 9 m, an Ancillary Zone wider than the recommended lower limit may overly constrain the Travelled Way. Where possible, the ancillary zone should be delineated through the use of surface materials which differ from the adjacent travelled way. These materials may include concrete, brick pavers, or stamped asphalt.

**Table 3.17** Design Domain: Ancillary Zone (in m)

Parameter	Recommended Lower Limit	Recommended Upper Limit
<b>Width*, Ancillary Zone</b>	2.1	2.5

\* Measured from face of curb.

#### 3.3.1.3 Parking, Loading & Deliveries

On-street parking is an important part of streets adjacent to street oriented land uses (e.g., commercial, public institutions). In this context, curbside space dedicated to loading/unloading can also accommodate deliveries of goods required by businesses. On-street parking, loading, and delivery spaces can also reduce motor vehicle travel speeds and can act as a buffer from moving traffic for people walking and wheeling and people cycling (if parking protected bike lanes are present). See Section 3.2.2.3 for Design Domain widths for parking, loading, and delivery lanes.

Parking should be restricted near two-way stop control intersections and mid-block crosswalks (marked or unmarked) so that visibility between people walking and wheeling, cycling, and driving from the right and the left is not obstructed.

Parking is legally prohibited within 5 m of the near side of a marked crosswalk, 5 m of a stop or yield sign, or 5 m of the projection of the curb or edge of the street. This may be controlled through a combination of signage and geometric elements, including curb extensions. Parking prohibition should also be based on sight triangles and stopping distances as per Section 3.6.1.4.

## PUBLIC REALM (CONT.)

### 3.3

#### 3.3.1.4 Accessible Parking

Accessible parking is motor vehicle parking that is dedicated through signs and pavement markings for the use of people that have parking placards for persons with disabilities. The Ancillary Zone provides the opportunity for dedicated 24-hour accessible parking, increasing the accessibility of destinations along the street to a broader range of people. Accessible parking in an urban context is illustrated in **Figure 3.31**

The width requirements for accessible parking are generally consistent with motor vehicle parking, but may require additional width of up to 3.7 m<sup>1</sup> to accommodate wheelchair access for the driver to get into and out of the vehicle. The increased width to accommodate accessible parking can be achieved by reducing the width of the Furnishing Zone for a short segment at the location of the accessible parking space(s). The placement of signs, street furniture, and landscaping must not impact access to the accessible parking stall. In addition, a curb ramp should be provided at accessible parking stalls for access. The design of this accommodation must not impact drainage and snow storage, and the curb ramp should be located as not to be negatively impacted by drainage infrastructure. Curb ramps should not be located through a catch basin nor in a sag location.

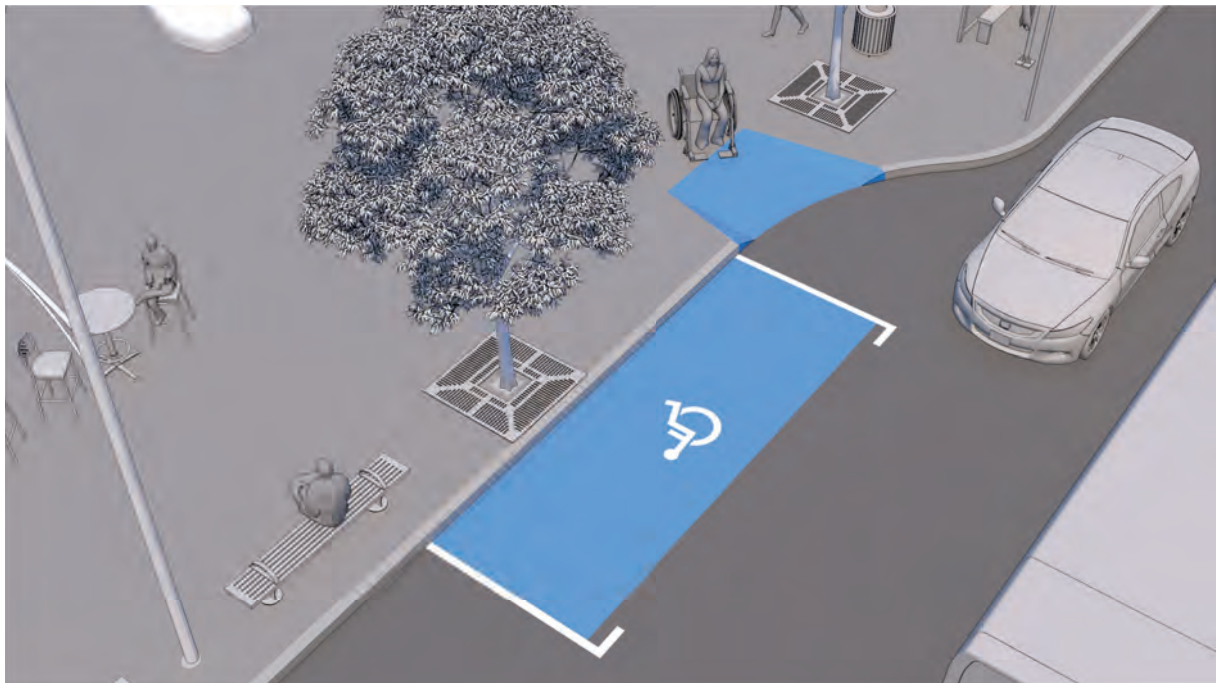

**Figure 3.31** Accessible Parking Design

<sup>1</sup> City of Toronto. 2004. Accessibility Design Guidelines.



## PUBLIC REALM (CONT.)

### 3.3

#### 3.3.1.5 Curb Extensions

Curb extensions or bulb-outs extend the curb into or toward the Travelled Way at intersections and midblock crossings. In doing so, curb extensions increase comfort and safety of streets by reducing crossing distances for people walking and wheeling, increasing the intervisibility between people walking and wheeling and passing drivers, increasing the visibility for people driving that are turning onto or of of streets, reducing motor vehicle operating speeds, increasing the available pedestrian queuing area, and facilitating buses to stop in the travel lane when passengers are boarding and alighting. Their design is influenced by the swept path of relevant Design Vehicles on a street. A curb extension is illustrated in *Figure 3.32*.

Curb extensions can also be spaces to locate traffic signal poles, bicycle parking, newspaper boxes, benches, on-street pay parking stations, landscaping, fire hydrants, and other uses such as bio-swales or oil/grit separators. The selection and placement of these types of street furniture or landscaping must consider intersection sightlines and underground utilities.



*Figure 3.32 Curb Extension in Ancillary Zone*

Curb extensions are best located where there is existing or proposed on-street parking, corners with marked crosswalks in high activity areas, locations with demonstrated safety issues for people walking and wheeling, wide streets, school crosswalks, or mid-block crossings.

Curb extensions are typically 2.0 m to 2.5 m in width (measured from face of curb of the street prior to the curb extension to the face of curb of the curb extension; depends on parking lane width) and at least 6.0 m long. A minimum radius of 4.5 m allows street sweeping and snow removal equipment to navigate the inside curves of the curb extension. Curb extensions have the potential to impact longitudinal drainage. This should be addressed by providing either a drainage line along the edge of lane line or providing additional catch basins. **Curb extensions containing landscaping should include a minimum 300mm header for the entire length of the extension.**

#### 3.3.1.6 Transit Stops on Curb Extensions

Transit stops on curb extensions (also known as transit platforms) are enhanced transit stops that are incorporated into a longer curb extension. They provide additional space for passenger waiting, loading, and unloading; provide space for additional or expanded amenities; and improve transit service reliability by removing the need for buses to merge back into traffic after picking up/dropping off passengers.

If provided, streets can accommodate a transit platform width of up to 3.95 m by using space from the Ancillary Zone and the Furnishing Zone. This width allows various enhanced transit stop amenities to be incorporated (e.g., benches, information kiosks, bicycle parking, larger shelters, etc.). The length of the curb extension should be determined by the length requirement of the bus stop.

## PUBLIC REALM *(CONT.)*

### 3.3

#### 3.3.1.7 Boardwalks

As illustrated in *Figure 3.33*, boardwalks are temporary or permanent walking platforms that route pedestrians through the Ancillary Zone and connect to the Pedestrian Trough Zone via the Furnishing Zone. Boardwalks can be used along streets to provide an expanded and/or diverted Pedestrian Trough Zone.

When provided, boardwalks should include a flush transition from the curb to avoid tripping hazards. Boardwalks include curb stops and flex posts with reflective tape at each end, a non-slip walking surface, and railing around the boardwalk. Boardwalks are typically 2.0 to 2.5 m wide (measured from face of

curb) while their length varies by location. The width of the boardwalk should be maximized wherever possible based on site constraints. The design of the boardwalk structure should not impede surface stormwater drainage from flowing along the street underneath the boardwalk. Railings must be designed to ensure they can be detected by people with visual impairments. Transitions between the boardwalk and sidewalk should include adequate radii to accommodate turning movements by people wheeling and using mobility aids. Boardwalks should be positioned to avoid existing hydrants while maintaining adequate separation distance and accessibility. Boardwalks are typically temporary elements that are installed during warmer months. Year-round boardwalks will require additional considerations for maintenance and snow clearing.



*Figure 3.33 Boardwalk in Ancillary Zone*

## PUBLIC REALM *(CONT.)*

### 3.3

#### 3.3.1.8 Parklets & Patios

Parklets are small scale public parks and seating areas while Patios (as illustrated in Figure 3.34) are typically associated with an adjacent business. When provided, parklets or patios can be located in the Ancillary Zone and provide additional public congregating space along streets to support them as destinations and places for people.

Parklets and patios can be temporary or permanent structures and should include a flush transition from the curb to avoid tripping hazards or, in the case of parklets, may include ramps to transition from the sidewalk to the street. Parklets and patios shall include a non-slip walking surface and railing around their edge (i.e., along the edge between the Ancillary Zone and Travelled Way) and shall also include curb stops and flex posts with reflective tape at each end. For some temporary installations, the surface may be the asphalt

or paving material of the Ancillary Zone. Seating and tables or other street furniture (e.g., flower pots) can be added to parklets and patios.

Parklets and patios are typically 2.25 m wide (measured from face of curb) while their length varies by location. The design of a parklet or patio structure should not impede surface stormwater drainage from flowing along the street underneath the parklet or patio. Parklets should be positioned to avoid existing hydrants while maintaining adequate separation distance and accessibility. Parklets should be placed and designed to avoid tree wells and minimize negative impacts on existing street trees. For year-round installations, further considerations related to snow clearing and street sweeping need to be incorporated into the design including the material selection. The design of each parklet or patio can be distinct to reflect the unique character of the street and, in the case of patios, the adjacent businesses associated with the patio.



Figure 3.34 Parklet in Ancillary Zone

## PUBLIC REALM (CONT.)

### 3.3

#### 3.3.1.9 Bicycle Parking Corrals

Bicycle parking corrals are arrangements of bicycle parking located in the Ancillary Zone, as illustrated in **Figure 3.35**. Bicycle parking corrals support access to businesses by more people while increasing safety for pedestrians by removing parked bicycles from the Furnishing Zone, decreasing encroachment of parked bicycles into the Pedestrian Trough Zone, and improving sightlines at intersections. Bicycle corrals are typically used in street oriented contexts.

Bicycle parking corrals can be temporary or permanent and typically replace one or more motor vehicle parking stalls with bicycle parking, providing 16 bicycle parking spaces in the space of 2 motor vehicle parking spaces. The lengthwise dimension of a bicycle is 1.8 - 3.0m as outlined in table 3.2. Bicycle corrals are typically located near intersections to increase their access to multiple bicycle routes. Bicycle corrals shall include areas allowing people to pull into and dismount from their bicycles within the corral. The location of the bicycle rack shall ensure that the rear of parked bicycles does not extend more than 2.25m from the curb. Bike parking corrals shall be positioned to avoid existing hydrants while maintaining adequate separation distance and accessibility. Bike corrals shall be offset from the intersection and outside of desired intersection sightlines.



**Figure 3.35** Bicycle Parking Corral in Ancillary Zone

#### 3.3.2 Transit Stops & Shelters

Transit stops are the fundamental interface for people accessing, loading, and unloading from buses or other transit vehicles. Street oriented contexts are destinations that strongly benefit from frequent transit service along the street and transit stops that are safe, accessible, and comfortable for transit passengers.

While not a design zone, Transit Stops and Shelters has been included as a separate sub-section because they can be located in either the Ancillary Zone or Furnishing Zone and, in some cases, the transit stop area can encroach into the Pedestrian Trough Zone and bicycle facilities. However, encroachment by fixed objects such as transit shelters and benches must be minimized to allow sufficient clear space for the horizontal operating envelope of a person walking and wheeling or cycling



**Figure 3.36** Transit Shelter (with sidewalk access and shelter oriented to protect waiting passengers from prevailing winds)

## PUBLIC REALM (CONT.)

### 3.3

#### 3.3.2.1 Locational Requirements

The placement of a transit stop before or after an intersection is referred to as a near-side or far-side transit stop, respectively. The placement of a bus stop on one side of an intersection or another is based on a number of factors including visibility, safety, transit operation, bus signal priority, intersection operations, parking restrictions, passenger demand, pedestrian access, or roadside constraints, as well as the City's Transit Service Standards. Far-side bus stops are preferable as they allow the bus to depart immediately after stopping, with near-side locations acceptable in some very limited conditions. Potential reasons for near-side configuration include:

- ✦ Locations with clear single direction transfer activity;
- ✦ Locations adjacent to signalized intersections;
- ✦ Locations where the head of the bus stop can be set 35 m from the intersection; and
- ✦ Locations where a bus stop curb extension (i.e., transit platform) is desirable on single lane streets.

Bus stops, particularly mid-block stops, shall not be placed in profile sag locations, where catch basins are installed, to prevent splashing of waiting passengers during rainfall events.

#### 3.3.2.2 Bus Pad Design Requirements

Refer to the standard detail drawings in Chapter 3 (Standard Drawings) for guidance on transit pad design for monolithic sidewalks and separated sidewalks.

#### 3.3.2.3 Transit Shelter Design Requirements

Providing comfortable space for transit users to wait is an important aspect of quality services which helps retain riders and grow ridership. The waiting areas should be designed to accommodate all user groups, including those with impairments, parents with strollers, older adults, and people with bicycles.

#### 3.3.2.4 Universal Design

From a universal design perspective, access to and from the shelter shall not be blocked by street furniture, signs, landscaping or tree planting and the shelter design must be wheelchair accessible.

#### 3.3.2.5 Detailed Drawings & References

Required transit stops or shelters are to be designed as shown on the standard detail drawing in Chapter 3 (Standard Drawings).

## PUBLIC REALM *(CONT.)*

### 3.3

#### 3.3.3 Furnishing Zone

##### 3.3.3.1 Locational Requirements

On streets with separated sidewalks, the Furnishing Zone (sometimes referred to as the boulevard) is located between the curb or pavement edge and the Pedestrian Through Zone, as shown in Figure 3.37. On streets where the sidewalk is monolithic (adjacent to the curb), the grass space behind the sidewalk can serve as the Furnishing Zone.



**Figure 3.37a** Furnishing Zone (Local)



**Figure 3.37b** Furnishing Zone (Urban)

## PUBLIC REALM (CONT.)

### 3.3

On streets with separated sidewalks, the Furnishing Zone serves as a safety separation, as well as a location for surface and shallow underground utilities, traffic signs, traffic signals, street light poles, other control devices, street trees, landscaping, transit shelters, benches, patios and seating associated with adjacent businesses, bicycle parking, hardware and street furniture, snow storage, and low impact drainage (e.g., bio-swale). The design of the Furnishing Zone shall consider the impact of snow clearing equipment and possible snow removal. For more information on low impact drainage (LID), refer to the City's LID Guidelines.

The recommended width of the Furnishing Zone is 1.7m to 5.0 m. The lower end of this range provides basic functionality, while the upper end allows for additional street-oriented uses of the right of way. The Design Domain of the Furnishing Zone is shown in Table 3.18.

**Table 3.18** Design Domain: Furnishing Zone (in m)

Parameter	Recommended Lower Limit	Recommended Upper Limit
<b>Width*, Furnishing Zone</b>	1.7	5.0

\* Measured from face of curb.

The recommended minimum width of 1.7m accommodates the width of the curb and sufficient soil volume to support the growth and health of mature street trees. Furnishing Zone widths below 1.7 m may not accommodate street trees and may limit the ability to have other plants that are healthy. When warranted by mitigating circumstances at the discretion of the City, Furnishing Zone widths less than the recommended lower limit may be utilized, but will require alternative landscape treatments such as hardscaping.

Situations where a wider Furnishing Zone approaching the recommended upper limit of 5.0 m may be suitable include:

- ✦ On high-speed, high volume streets (i.e., where adjacent traffic speeds are 60 km/h or higher and volumes are 10,000 vehicles per day or higher) for the increased comfort of people walking and wheeling;
- ✦ On streets with transit service (typically collectors and arterials) for potential transit facilities such as transit stop pads and bus shelters;
- ✦ On streets with larger corner radii, to increase offset of the sidewalk and better align with the location of the curb ramp and crosswalk;
- ✦ On commercial/mixed use or main streets for street furniture;
- ✦ On streets where significant amounts of vegetation and street trees are desired; and,
- ✦ On wide, non-street oriented arterial streets to accommodate more space for snow storage.

Where fire hydrants are proposed in the Furnishing Zone, additional width may be required to ensure adequate offsets are maintained as per the City's Design and Construction Standards Volume 4.

## PUBLIC REALM *(CONT.)*

### 3.3 3.3.3.2 Street Trees & Landscaping/Hardscaping

Street trees and landscaping are critical elements of Edmonton's urban streets and should be prioritized accordingly due to their contributions to an urban space; providing climate control (micro-climates) from heat, wind, and rain; reducing traffic speeds; improving pedestrian safety; and adding value to adjacent Properties.

Street trees and landscaping can include a variety of species. Adequate tree spacing and soil volume is required for healthy tree growth and is dependent on tree species. The soil volume can be located under a combination of the Furnishing Zone, Pedestrian Trough Zone, and Ancillary Zone or Travelled Way through the use of soil cells. Information pertaining to tree selection, soil volume, spacing, and landscaping requirements for all street functional classifications (arterial, collector, local) can be found in Volume 5 of the Design and Construction Standards.

In street oriented commercial contexts, due to the level of activity within the Ancillary Zone with people accessing and exiting parked vehicles and/or protected bike lanes, a hardscaped Furnishing Zone is preferred. It can be in the form of concrete, paver stones, brick, or other hard surface. Using a different surface material from the Pedestrian Trough Zone can assist with Universal Design.

Street trees may obscure sightlines and visibility at intersections and mid-block crosswalks. As such, plant selection (i.e. smaller caliper deciduous trees free of low branches) and placement shall strive to maintain sightlines. See Section 3.6.1.4 for sightline requirements.

#### *Constrained Conditions*

If Furnishing or Frontage Zones are too narrow, if sidewalks are adjacent to curbs, or if ordinances and setback requirements eliminate trees from the Furnishing or Frontage Zones, plantings/shrubs can be utilized as an alternative to street trees. Areas can also be hardscaped with paving stones or other materials.



## PUBLIC REALM (CONT.)

### 3.3

#### 3.3.3.3 Street Lighting

Street lighting is used to illuminate the public right of way and its various users. Lighting can be more person-friendly if designed and spaced at a humanscale commonly referred to as “pedestrian-oriented lighting”. Human-scaled lighting contributes to safety for people walking and wheeling, and supports urban streets as places.

Pedestrian oriented lighting should be considered where street-oriented commercial or mixed use development exists or is planned, or where high volumes of pedestrian traffic are anticipated. Special consideration should also be given to school zones, playgrounds, and crosswalks to ensure adequate levels of lighting. Placement of pedestrian oriented lighting should also consider the City’s dark skies initiatives to minimize light pollution where possible

Pedestrian-oriented lighting should be placed with a spacing of 30 m and height above the sidewalk

surface of approximately 5 m to provide sufficient illumination of the Pedestrian Through Zone. This spacing also works well for street tree locations, however, spacing should be modified as needed to accommodate street tree locations. Pedestrian-oriented lighting fixtures can be affixed to the same pole as street lighting or on separate poles.

Light fixtures for the Travelled Way spaced every 60 m complements the 30 m pedestrian lighting spacing. Street lighting shall also be added to traffic signal poles to increase the illumination and safety of intersections. Street lighting is illustrated in Figure 3.38. In all cases, appropriate lighting shall be provided at all pedestrian crossings, including midblock, to ensure adequate inter-visibility between street users.

More information on street lighting can be found in Volume 6 of the Design and Construction Standards and the TAC Guide for the Design of Roadway Lighting



Figure 3.38 Street & Pedestrian Lighting Spacing

## PUBLIC REALM *(CONT.)*

### 3.3

#### 3.3.3.4 Street Furniture

Street furniture includes functional and decorative elements that support the function and use of the street and the creation of a people place. Street furniture can include elements such as poles for traffic signals and lighting, benches, bicycle parking, flower pots, waste receptacles, bollards, banners, tables and chairs, advertising boards, signal boxes/traffic controllers, fire hydrants, pay parking stations, newspaper boxes, wayfinding, sign poles, and public art. Placement of street furniture shall be consistent to make the street more predictable for the visually impaired.

The amount and type of street furniture will vary depending on the adjacent building locations and orientation, the number of people using an area, the width available for the Furnishing Zone, the presence of an Ancillary Zone and/or Frontage Zone, and the characteristics and design of the Travelled Way. In

general, all streets shall provide waste receptacles and bicycle parking as well as necessary functional items (e.g. traffic signal poles, street lights, traffic controllers/signal boxes, fire hydrants, etc). Street furniture should be aligned, clustered, and integrated with utilities and other appearances wherever possible. Street furniture should not be placed within the pedestrian through the zone.

The design of the street furniture can be used to achieve more than one purpose (e.g. seating and art, planter and seating). The Furnishing Zone surface material (e.g. pavers, concrete, etc), needs to allow for installation of street furniture. When designing street furniture, consideration must be given to their long-term maintenance, snow clearing, snow storage, and the need to replace damaged pieces. Snow clearing operations may need to be adjusted to ensure that damage to furnished zone is minimized, and to allow on-street parking access to the sidewalk year-round.

## PUBLIC REALM *(CONT.)*

### 3.3

#### 3.3.4 Pedestrian Through Zone

##### 3.3.4.1 Locational Requirements

The Pedestrian Through Zone is the area where people walk, interact with one another, and access adjacent buildings and destinations. Sidewalks, walkways, paths, and trails shall form a comprehensive and integrated pedestrian circulation system within a neighborhood and between neighbourhoods. This may mean sidewalks on both sides, shared pathways on both sides, or a sidewalk on one side and a shared pathway on the other. Vehicle driveways across the pedestrian through zone shall be limited where rear alley access is available, and existing accesses should be reviewed during infrastructure renewal activities.

To ensure that the design of the pedestrian environment accommodates the greatest possible number of people, it is desirable to adhere to the following:

- Allow a clear path of travel, free of obstructions;

- Provide a firm, non-slip, and glare-free surface;

- Ensure that gradients along the path of travel are gradual to allow access by all and that landings are added (See Section 1.5 on Universal Design & Accessibility and Section 3.3.4);

- Limit vehicle driveways across the Pedestrian Through Zone to minimize disruption and improve safety (and review existing accesses during street renewal activities).



Figure 3.39 Pedestrian Through Zone

## PUBLIC REALM (CONT.)

### 3.3

For facilities within street rights of way, a sidewalk, walkway, or pathway shall be provided as described below:

- +** Arterial Streets

  - +** Shared Pathway on both sides
  - +** Sidewalk on both sides if protected bike lane is provided; on one side where SUP is provided on one side only
  - +** All facilities must be separate
- +** Collector Streets

  - +** Shared Pathway possible on one side
  - +** Sidewalk on both sides where no shared pathway is provided; on one side where SUP is provided
  - +** All facilities must be separate
- +** Industrial Collector Streets

  - +** Shared pathway one side
  - +** Sidewalk minimum on one side, with connections to side streets
  - +** All facilities must be separate
- +** Local Streets

  - +** Sidewalk on both sides of the street
  - +** Sidewalk can be monolithic or separate
- +** Industrial Local Streets

  - +** Shared Pathway on one side
  - +** Sidewalk minimum on one side unless SUP is provided
  - +** All facilities must be separate
- +** School Sites

  - +** Monolithic walk adjacent to all school sites
- +** Transit Stops

  - +** Sidewalk connections required to all bus stops, must connect to crosswalk to provide access to facility if it is on the other side of the street
- +** Other Locations

  - +** Shared pathways shall be constructed where necessary for connectivity of the cycling and walking and wheeling network at the discretion of the City.
  - +** Sidewalks shall be constructed in all locations that, in the opinion of the City, generate significant pedestrian traffic

## PUBLIC REALM (CONT.)

### 3.3

#### 3.3.4.2 Pedestrian Through Zone Width

Pedestrian Through Zone width is a function related to the horizontal operating envelope of people walking and wheeling and the volumes of these activities. The preferred Pedestrian Through Zone width for a high activity area is 3.0 m to accommodate the higher walking and wheeling volumes and to allow people to walk in groups. In areas with lower volumes, the minimum through zone width is 1.8 m. This width will allow a person holding a child’s hand to pass another person, as well as a person using a wheelchair to pass a person walking or complete maneuvering movements, or two passing wheelchair users.

**Table 3.19** summarizes the Design Domain dimensions for the Pedestrian Through Zone (clear sidewalk) based on street classification and adjacent land uses of people walking and wheeling. The Design Domain for shared pathways is provided in Section 3.2.3. Recommended offsets to landscaping, poles, and street furniture are provided in Section 3.7.

Universal Design related to intersections can be found in Section 3.6.4 including the use of tactile walking surface indicators.

**Table 3.19:** Design Domain: Pedestrian Through Zone (in m)

Parameter: Width, Pedestrian Through Zone		Recommended Lower Limit	Recommended Upper Limit
<b>Local Street</b>	Monowalk or separated sidewalk	1.8 <sup>1</sup>	N/A
<b>Industrial Local Street</b>	Monowalk	2.3	N/A
	Separated sidewalk	1.8	N/A
<b>School Zone</b>	Monowalk	2.5	N/A
<b>Collector Street</b>	Monowalk	2.3	N/A
	Separated sidewalk	1.8 <sup>1</sup>	N/A
<b>Industrial Collector Street</b>	Monowalk	2.3	N/A
	Separated sidewalk	1.8	N/A
<b>Street Oriented Arterial Street<sup>3</sup></b>	Separated sidewalk <sup>2</sup>	2.5	N/A
<b>Non-Street Oriented Arterial Street<sup>3</sup></b>	Separated sidewalk	1.8	N/A
<b>Main Street/High Activity Area<sup>3</sup></b>	Separated sidewalk	3.0	N/A

**Notes:**

1. In constrained retrofit locations, the minimum width of the Pedestrian Through Zone can be reduced to 1.5 m measured from face of curb to back of sidewalk for monowalk or edge to edge for separated sidewalks.
2. Monolithic sidewalks are not recommended along arterial streets. Where monolithic sidewalks cannot be avoided due to site constraints at the discretion of the City, the sidewalk width must be increased by a minimum of 0.5 metres.
3. The use of sidewalks along arterial streets will require alternate bicycle accommodation where shared pathways are currently being provided.

## PUBLIC REALM (CONT.)

### 3.3

#### 3.3.4.3 Universal Design

Edmonton’s streets must be designed to accommodate travel by the full spectrum of people walking and wheeling including those that use mobility aids.

An accessible Pedestrian Through Zone allows people of all ages and abilities to travel to, travel through, and access buildings along all streets. The Design Domain dimensions for the Pedestrian Through Zone are based on providing a universally accessible Pedestrian Through Zone as a primary principle. In addition, the horizontal clearances (Section 3.1.3.1) and requirement for an obstruction-free clear space for the sidewalk allows for continuity and ease of navigation for people with mobility and vision impairments. Vertical grades that support Universal Design are provided in Section 3.5.7.

Universal Design related to intersections can be found in Section 3.6.4 including the use of tactile walking surface indicators.

#### 3.3.4.4 Surface Materials

While sidewalk surfaces shall be smooth and free of debris and obstacles, the choice of sidewalk construction materials provides an opportunity to enhance the visual aesthetics and experience for people walking and wheeling.

Always consider the impacts of decorative paving on the mobility challenged and visually impaired. Slippery materials or uneven surfaces should never be used in the Pedestrian Through Zone or a sidewalk. For most sidewalks, concrete offers the most effective travel surface. Decorative scoring patterns or colour may be laid into concrete as a simple way to add visual interest to the walkway

#### 3.3.4.5 Pedestrian Through Zone at Driveways

Any ramps for motor vehicle access at driveways to transition from the Travelled Way or Ancillary Zone elevation to the elevation of the Pedestrian Through Zone shall occur entirely within the furnishing and/or Ancillary Zone. This allows the Pedestrian Through Zone to remain flat or essentially flat. This is illustrated in **Figure 3.40A**.

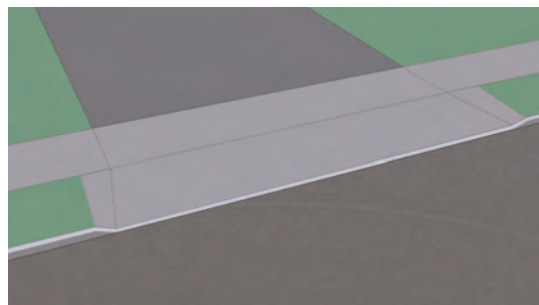

**Figure 3.40A:** Driveway crossing of a separated sidewalk

In locations with monolithic sidewalks, the driveway ramp may have to be located within the Pedestrian Through Zone. In these instances, a minimum flat segment of Pedestrian Through Zone of 1.0 m wide should be provided, as illustrated in **Figure 3.40B**. This flat segment should be provided whenever a straight face curb is utilized and the sidewalk is a minimum 2.3 m in width. Where straight face curb exists, but sidewalk widths are less than 2.3 m, this may require a widening of the Pedestrian Through Zone and use of space in the Frontage Zone where it is available.

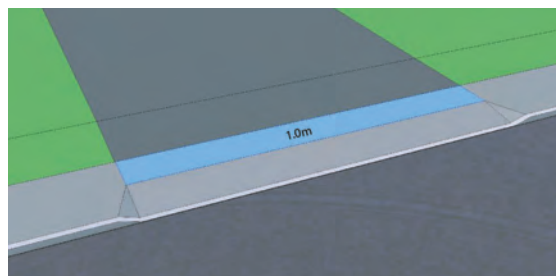

**Figure 3.40B:** Driveway crossing of monolithic walk

## PUBLIC REALM (CONT.)

# 3.3

### 3.3.5 Frontage Zone

#### 3.3.5.1 Locational Requirements

Located adjacent to the building and/or property line, the Frontage Zone provides people walking and wheeling with an offset distance from adjacent lands, and provides clearance from building fronts, doors opening outwards, utilities, and architectural features, and can be utilized for patios and street displays. The Frontage Zone is illustrated in **Figure 3.41**.



**Figure 3.41** Frontage Zone

#### 3.3.5.2 Design Requirements

The Design Domain recommended width of the Frontage Zone is 0.3 m to 4.5 m. The lower end of this range provides basic functionality and accommodation of some underground utilities to be located outside the Pedestrian Through Zone. The upper end allows for additional uses to support a walkable environment.

The recommended width of the Frontage Zone is influenced by physical conditions at the property line. Generally, a greater width is more appropriate from building edges than from lawns or pavement. The latter may require no Frontage Zone at all. Involvement of the adjacent land owners and business operators often

contributes significantly to the design and use of the Frontage Zone. The width of the frontage zone should also consider building setbacks, and opportunities may exist to develop frontage zones in collaboration with adjacent property owners. Table 3.20 summarizes the Design Domain for the Frontage Zone. In some cases, a Frontage Zone may not be possible where right of way is constrained.

**Table 3.20** Design Domain: Frontage Zone (in m)

Parameter	Recommended Lower Limit	Recommended Upper Limit
<b>Width, Frontage Zone</b>	0.3 <sup>1</sup>	4,5

**Note:**

1. *Frontage zone may be reduced to 0.0 metres in Main Streets or where there is constrained right of way, at the discretion of the City.*

To accommodate different activities, the following may assist with selection of a Frontage Zone width based on the context of the street:

- + 0.9 m width accommodates advertising boards, or other small signage, and lineup areas
- + 1.2 m width accommodates display and sales tables plus standing space for browsing shoppers. This width also accommodates small restaurant tables with seating for two people plus circulation space for service staff
- + 1.75 m accommodates restaurant tables with seating for four people plus circulation for service staff.

In all cases, the Frontage Zone shall be designed in a way which enables navigation for persons

## PUBLIC REALM *(CONT.)*

### 3.3

#### 3.3.6 Berms

Berms shall only be developed at those locations where, in the opinion of the City, their construction will not interfere with the normal lot drainage of abutting properties. Where lot drainage problems could occur, the berm shall be constructed to provide a positive drainage swale on the property side of the berm that has been developed in accordance with the approved lot grading plan. The berm slopes shall not be steeper than 3:1 where there is landscaped sideslope. The edge of berm shall not be closer than 1 m from the edge of the walkway. Lot drainage problems affecting lots that conform to the lot grading plan and resulting directly from the development of the berm shall be the exclusive responsibility of the Developer.

Grading shall be done in accordance with the landscaping plan. The grades shall conform to the gradient of the sidewalk/walkway/shared pathway to avoid conflicts with the drainage pattern within the right of way. For walkway grading requirements, see Section 3.5.7.



## ROADSIDE

### 3.4

In the context of non-urban areas, the roadside refers to the area between the pavement edge and the adjacent property line. Non-urban areas in Edmonton are typically industrial or with agricultural land uses where street designs do not include an urban cross section. Drainage in these contexts uses overland drainage via ditches instead of curb and gutter.

Due to land use context and associated street types/ user demands, streets in non-urban areas typically include a roadside that accommodates different functional zones than in urban areas: side slope, drainage channel, and backslope (with accommodation for people walking, wheeling, and cycling). Within the non-urban areas, these roadside functional zones are typically included in the Clear Zone.

The design of a non-urban roadside shall take into consideration the potential future use of the area; non-urban streets can become urbanized as boundaries expand.

Non-Urban Roadside Areas are illustrated in [Figure 3.42](#)

Information on offsets for design elements within the Non-Urban Roadside Areas, including with respect to the Travelled Way, can be found in Section 3.7. This includes horizontal offsets and clearances to utilities,

poles, and trees. Requirements for Sight Distances and Clear Sight Triangles at intersections can be found in Section 3.6.1.4.

#### 3.4.1 Clear Zone

Much of the non-urban roadside falls into the Clear Zone, which is part of the Recovery Zone (see [Figure 3.43](#)). The Recovery Zone is the total unobstructed traversable area available along the edge of the street and, by convention, it is measured from the edge of the closest through travel lane. Clear Zones support the Safe Systems Approach by making the road forgiving of driver error along the higher speed streets that typically have non-urban roadsides (e.g., freeways, high speed arterial streets).

The Recovery Zone may have recoverable slopes, non-recoverable slopes, and a clear run-out area. The elements of the Clear Zone are described below and illustrated in [Figure 3.43](#).

- ✦ Recoverable slopes are those on which a driver may, to a greater or lesser extent, retain or regain control of a vehicle;
- ✦ A non-recoverable slope may be traversable, but a vehicle will continue to the bottom; and

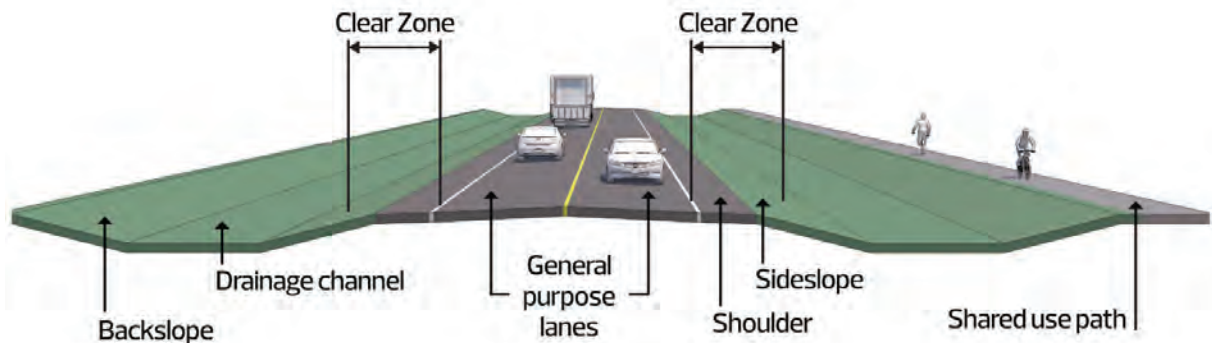

[Figure 3.42](#) Non-Urban Roadside Areas

## ROADSIDE (CONT.)

### 3.4

- + A clear run-out area is located at the toe of a non-recoverable slope, and is available for safe use by an errant vehicle

The wider the Clear Zone in non-urban areas, the lower the frequency and severity of collisions with fixed objects. However, there is a point beyond which any further expenditure to move or protect the fixed objects is not warranted because the marginal risk reduction is too small.

The Clear Zone Design Domain for non-urban areas reflects the influence of:

- + Design speed;
- + Traffic volumes;
- + The presence of cut or fill slopes;
- + The steepness of slopes; and,
- + Horizontal curve adjustments

Design Domain guidance for the Clear Zone is presented in two parts: a quantitative guide to generally accepted values used for the clear zone under varying circumstances and a set of heuristics and/or practices which should be considered by designers in applying these values. The former must not be used without the latter. Details on calculating non-urban area Clear Zones and design decisions around it can be found in TAC GDG Section 7.3; the decisions around elements and size of Clear Zone are not exact, and require analysis of the various options to make final decisions.

Design Domain of specific elements within the non-urban roadside should follow the Design Domains identified in Section 3.3 (e.g., Design Domain width of shared pathways).

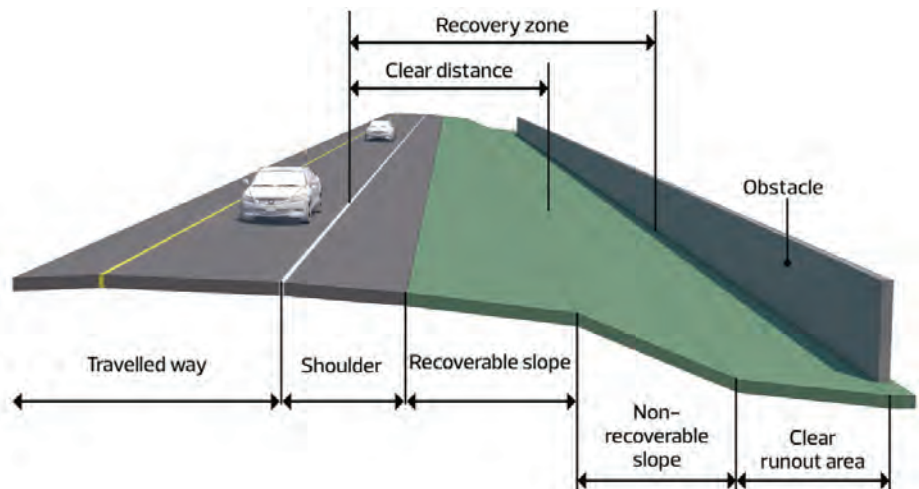

Figure 3.43 Non-Urban Roadside Recovery Zone

## ROADSIDE (CONT.)

### 3.4

#### 3.4.2 Non-Urban Active Transportation Requirements

For people walking and wheeling, non-urban area streets involve different risks than urban streets, such as unlit night-time conditions and high motor vehicle speeds. To facilitate safe and comfortable access, non-urban area street design should mitigate these risks through lighting, signage, and the provision of shared-use paths or sidewalks. **Table 3.21** summarizes the requirements for people walking, wheeling, and cycling on non-urban area streets.

**Table 3.21** Roadside Accommodation for People Walking, Wheeling, and Cycling on Streets in Cross Sections (i.e., Non-Urban Areas)

Speed Limit	Walking/Wheeling & Cycling Facilities
≥40 km/h	shared pathways off the Travelled Way
<40 km/h	Sidewalks off the Travelled Way or on-street bicycle facilities

Night conditions are particularly hazardous for people walking, wheeling, and cycling along non-urban streets because street lighting is often absent. Where warranted by the methodology outlined in the Volume 6 of the City of Edmonton’s Design and Construction Standards, the roadside design of new streets in non-urban areas shall incorporate street lighting that effectively illuminates the entire Travelled Way and roadside.

#### 3.4.3 Non-Urban Transit Stops & Shelters

The City requires an appropriate transit stop and amenity pad be constructed as part of new transit stop pad construction. The unconstrained accessible pad dimensions for a transit stop along a non-urban street are 2.25 m by 9.0 m, with a 0.3 m minimum clearance to the property line.

The amenity pad shall be constructed with an adjacent curb and gutter section. A hard surfaced connection from the sidewalk/shared pathway located on the backslope of the ditch to the bus stop amenity pad is required. The connection will include a ditch crossing with appropriately sized culverts and must include a sidewalk or shared pathway constructed with concrete. See the standard detail drawings in Chapter 3 for bus stops and pads in non-urban areas

#### 3.4.4 Drainage in Non-Urban Areas

TAC GDG Section 7.4 covers roadside safety issues related to proper ditch, culvert and related drainage structure design .

Incorporating good drainage practice within a safe roadside design can be a difficult challenge. In addressing this challenge, designers should explore the following options, in order of preference:

- ✦ Eliminate non-essential drainage structures;
- ✦ Design drainage structures so they present a minimal hazard to errant vehicles, including providing traversable structures; and,
- ✦ Provide shielding with a suitable barrier for any structures that cannot be redesigned or relocated to eliminate their potential threat to errant vehicles.

TAC GDG Section 7.4 addresses these options in the context of Design Domain guidelines that are primarily feature-oriented and framed around the primary types of drainage structures. In applying them, designers must consider their interaction with both the Clear Zone principles, as well as those outlined in discussions regarding traffic barriers (see TAC GDG Section 7.6).



## OFF-STREET PATHS/TRAILS *(CONT.)*

### 3.5

#### 3.5.2 Path/Trail Width

Off-street paths are the same in design concept as shared pathways. Design Domain dimensions for the width of shared pathways are discussed in Section 3.2.3.2 and can be used for granular trails as well. Further design requirements are provided in Section 3.6.11, if an off-street path/trail is to be used for emergency access.

#### 3.5.3 Drainage

A cross slope of 2% is recommended for proper drainage of off-street paths, walkways, and trails. Surface drainage from the path/walkway/trail will dissipate as it flows down gently sloping terrain. However, if a path/walkway/trail is constructed on the side of a hill, a drainage ditch or swale may be necessary on the uphill side to intercept the slope drainage.

A culvert or bridge shall be used where a path/walkway/trail crosses a drainage channel. Sizing of the required culvert opening should be determined by a hydraulics engineer and see the City's Design and Construction Standards Volume 3.

For off-street paths, walkways, and trails in flatter environments, ditches may be required to accommodate rain and snow melt to ensure the path/walkway/trail is not flooded and that ice is not formed in colder months.

#### 3.5.4 Landscaping and Amenities

Landscaping elements shall be specified on the landscaping plans in accordance with the requirements of the City's Design and Construction Standards Volume 5. The placement of any plants must consider the "as-planted" sightlines, and "as matured" sightlines. Benches shall be provided and placed at strategic locations along the off-street path/trail. The benches shall be located a minimum of 1 m from the edge of the path/trail.

Waste receptacles shall be provided where major off-street paths/trails intersect with streets. The waste receptacles shall be of the standard type defined for off-street paths/trails use by the City and shall be located within the off-street path/trail right of way and no more than 3 m from the street right of way. Additional waste receptacles shall be provided along off-street paths/trails as per the City's Design and Construction Standards Volume 5.

The lighting design and other utilities must be shown on the construction plan submitted for City approval.

#### 3.5.5 Pipelines, Railways & Stormwater Facilities

Where off-street paths/trails cross or are located within an existing major utility or pipeline right of way, the designer will be responsible to obtain proper written permission/agreement with the appropriate authority prior to construction. The designer will be asked to produce a copy of a plan approved by the appropriate authority permitting construction of the off-street path/trail within the utility or pipeline corridor.

A crossing agreement or proximity agreement may be required if the path/trail or required work area is adjacent to the pipeline right of way. Agreement will be necessary where work occurs within 30 metres of a Pipeline.

Railway crossings require approvals, and as part of these approvals rail companies often require upgrades to their crossing lighting systems for the new off-street path/trail, which could add costs to the project.

When the alignment of a pedestrian facility is planned within the footprint of a stormwater management facility (SWMF), the designer should provide due consideration to how the operation of the SWMF will impact operation of the off-street path/trail. This may include making provisions to locate the facility above the 1:25 year flood line to ensure minimal disruption or conflict, or revising the alignment to ensure proper longitudinal drainage is maintained.

## OFF-STREET PATHS/TRAILS (CONT.)

### 3.5

#### 3.5.6 Horizontal Alignment

The alignment of off-street paths, walkways, and trails intended to accommodate multimodal transportation and recreational uses should use a Design Speed outlined in Section 3.2.1.2 when laying out the alignment and determining sightlines and vertical profiles. Refer to Section 3.2.6.3 for more details on horizontal alignment for bicycle facilities.

#### 3.5.7 Vertical Alignment

The vertical alignment of off-street paths/walkways/trails should be integrated with the horizontal alignment, drainage, and berm design. Since off-street paths are used as self-contained drainage corridors, the off-street path/trail should be designed to facilitate positive drainage flow. The normal longitudinal grade of the walkways is 0.6% and the minimum permitted grade is 0.5%. The crossfall should be a designed at 2% with a landscape swale offset from the walkway. See also Section 3.5.3.

In addition to the above, **Table 3.22** provides guidance on the provision of landings for sidewalks, shared pathway, and walkways to create rest areas for people with disabilities traversing extended slopes. The provision of landings supports Universal Design of both on-street and off-street walking and wheeling infrastructure

**Table 3.22** Sidewalk/Walkway/shared pathway/Trail Grading Requirements

Maximum Slope	Maximum Length	Maximum Height	Landings
≤2%	None	None	Not required
>2% to ≤5%	None	None	Note 1
>5% to ≤6.25%	12 m	750 mm	Every 12 m
>6.25% to ≤8.30%	9 m	750 mm	Every 9 m
>8.30% to ≤10%	1.5 m	150 mm	Note 2

**Notes:**

1. Landings at 750 mm elevation difference are desirable.
2. It is recognized that the gradient and building layout on some streets may make the provision of landings impractical.

## INTERSECTIONS

### 3.6

This section provides guidance to street designers in the design of and preparation of drawings for intersections and crossings for all modes based on the Safe Systems Approach.

*An intersection is defined as the location where two or more streets join or cross at-grade, including on-street and off-street for all modes of travel. An entrance or exit from an adjacent property (i.e., driveway) is considered an access and not an intersection.*

Intersection design is based on geometric elements including horizontal alignment, vertical alignment, and cross section components. The design of an intersection requires integration of these elements with the physical constraints, multimodal traffic characteristics, and environmental requirements of the intersection, as well as the functional classification of the intersecting streets. Intersection design that is safe and comfortable for vulnerable road users of all ages and abilities (including those with disabilities), cycling, driving, operating transit, and delivering goods, while prioritizing safety.

Intersections must be designed to be universally accessible and follow Universal Design principles. Universal Design principles for intersections are:

- ✦ Make approaching, entering, and using an intersection easy for people walking and wheeling of all ages and abilities;
- ✦ Provide streets and intersections that are both convenient and safe for all users, particularly those with mobility issues;
- ✦ Emphasize dignity and independence, providing those features that will allow all people to function in their day-to-day activities;
- ✦ Consider accessibility in all seasons and conditions; and
- ✦ Be successfully integrated with an intersection's function and form.

## INTERSECTIONS (CONT.)

### 3.6

#### 3.6.1 Functional Requirements

##### 3.6.1.1. Design Process

Intersection planning and design involves consideration of current and future transportation needs, as well as zoning and planning context to determine the function and requirements of the intersection. Other considerations in the planning process include how intersection design can be influenced by the physical environment, human factors, policy, economic factors, and local issues. Intersection design is an iterative process where, like cross section design, options are refined to ensure consideration of all factors and achieve the most appropriate design.

When designing an intersection, it is also important to consider the needs and specific limitations of all street users (e.g., people walking and wheeling, cycling, and driving) and their vehicles, as well as the safety of all street users. Applying this requirement should result in designs that satisfy the following principles:

- + A street user’s expectations of the design are not violated (i.e., strangers to an area are not surprised by the location of the intersection, or its layout, and there is consistency in design from one location to the next along a corridor); and
- + The design provides a level of forgiveness for street user errors by:
  - + Minimizing exposure to conflicts;
  - + Reducing speeds at conflict points;
  - + Communicating right of way priority; and
  - + Providing adequate sight distance.

Specific considerations for various street users are summarized in TAC GDG Section 9.3.2.

The process of intersection design involves identifying operational and geometric requirements that are interrelated, and determining the information that needs to be presented on design plans. **Figure 3.45** highlights the intersection design process.



Figure 3.45 Intersection Design Process Flow Chart



## INTERSECTIONS (CONT.)

### 3.6

#### 3.6.1.2 Intersection Types

##### Basic Intersection

There are two basic intersection types as follows:

- + **Simple Intersection** – where the normal lane width of the main street is maintained through the intersection and minimum corner radii are provided (typically single radius curves). Such intersections may have auxiliary lanes (i.e., right or left turn lanes); and
- + **Channelized Intersection** – channelization of an at-grade intersection separates and directs driving, walking and wheeling, and cycling movements and crossings into defined paths. To do so, it uses geometric features, pavement markings, traffic control devices, and other positive guidance elements, as needed.

Basic intersection configurations are discussed in more detail in TAC GDG Section 9.2.4 while Figure 3.46 illustrates the typical right turn lane and left turn lane configurations. .

*Simple Intersection*



*High Entry Angle (Right Turn Channelization Yield)*



*Low Exit Angle (Right Turn Channelization Merge)*



*Low Exit Angle (Right Turn Channelization Free-Flow)*



*Left Turn Lane (Single Parallel)*



*Left Turn Lane (Single Slotted)*



*Left Turn Lane (Dual Slotted)*



**Figure 3.46** Basic Intersection Configurations

## INTERSECTIONS *(CONT.)*

### 3.6

#### *Retrofit Intersection*

An intersection retrofit is an improvement or change to an existing intersection. Retrofitting urban intersections is often needed to meet changing traffic demands or to implement operational improvements that increase safety, accessibility, and efficiency. An intersection retrofit may involve many alterations to geometric elements such as introducing or modifying channelization, improving undesirable geometric conditions that affect driving, transit, cycling, and walking and wheeling safety, incorporating curb ramps and refuge areas, and implementing traffic calming measures, or may include conversion to a roundabout (See Section 3.6.7 for Roundabouts).

#### **3.6.1.3 Horizontal and Vertical Alignment Considerations**

Like mid-block segments, intersection design is influenced by functional classification, land use context, and building orientation of the intersecting streets. These elements define the purpose of the streets and intersections and how they should function. Every intersection layout is also defined by specific multimodal traffic operational requirements and site conditions that must be considered to identify and address safety concerns. After the intersection location, general alignment, and traffic control measures have been determined, the detailed alignment of each leg of the intersection must be established.

#### *Horizontal Alignment*

General considerations for the horizontal alignment of intersections (such as streets, curb ramps, and sidewalks) include:

- ✦ Location of intersections on curves is not desirable due to decreased visibility (and inter-visibility), increased conflict potential for people crossing the major street, and complications with street superelevation on higher speed streets; and
- ✦ Intersecting streets should meet at, or within 10 degrees of a right angle (90 degrees). This reduces the size of the conflict area, improves visibility/inter-visibility, and decreases the severity of collisions relative to those occurring at greater angles. In locations where angles are between 10 to 20 degrees of 90 degrees, depending on collision history and/or performance concerns, realignment of the intersecting streets should be considered. In some cases, realignment of the intersecting streets to achieve an angle within 10 degrees of 90 degrees may not be cost effective. Detailed discussions on acceptable solutions are provided in TAC GDG Section 9.7.2.

## INTERSECTIONS *(CONT.)*

### 3.6

#### *Vertical Alignment*

General considerations for the vertical alignment of intersections (such as grades) include:

- ✦ Profiles of the minor streets are typically adjusted to match those on the major streets. In some situations, adjusting the major street slightly may assist in smoothing out the profile of the minor street as it intersects;
- ✦ Cross slopes can be adjusted between 1.0% to 3.0% without affecting the efficient operation of traffic along the major street and the universal accessibility of people traversing the cross slope. Cross slopes less than 1.0% should be avoided due to potential drainage problems. Figures on cross slope concepts and transitions are provided in TAC GDG Section 9.7.3;
- ✦ Grade breaks between 0.5% to 2% are desirable for Design Speeds of 70 km/h or higher. For Design Speeds of less than 70 km/h, the maximum recommended grade break is 4% (and 6% for 30 km/h) to avoid impacts to people driving. Stopping sight distance must be achieved when using maximum grade breaks; and
- ✦ Grades of intersecting streets should be as flat as possible, while still achieving minimum grades for drainage.

#### *3.6.1.4 Sight Distance & Clear Sight Triangles*

The avoidance of collisions and the efficiency of operation depends on the judgement, capabilities, and responses of each user. Thus, it is important to provide the appropriate reaction and decision time for street users to clearly see the intersection, identify any potential conflict approaching and passing through the intersection, and make the appropriate decision to stop or otherwise avoid the conflict. Intersection design must provide adequate sight distance for all users of the intersection. Restricting obstructions in areas along the intersection approaches and across corners gives users more time to complete their visual search and ensure that they have sufficient time to react.

#### *Sight Distance*

The minimum sight distance requirement for people driving vehicles approaching an intersection is the stopping sight distance (SSD), which is based on Design Speed and the stopping distance of the Design Vehicle/ User. Due to the complex situations that people driving may encounter at intersections, it is desirable to provide more than the minimum stopping sight distance to enhance safety wherever possible.

## INTERSECTIONS (CONT.)

### 3.6

To this end, providing decision sight distance (DSD) is desirable in advance of the critical intersection decision points. These decision points include locations where people driving must make prompt choices regarding lane selection, where information and potential conflicts are difficult to perceive, and where unexpected maneuvers may be required. Values for SSD and for DSD over a range of Design Speeds are provided in TAC GDG Section 2.5.3 and 2.5.5 respectively. Table 3.23 provides example SSDs for the operation of passenger cars at varying grades for varying Design Speeds.

Sight distances are also important for people riding bicycles for both on-street and off-street bicycle facilities. The minimum sight distance that must be provided for people riding bicycles is the minimum stopping distance, which is the distance required to bring a bicycle to a controlled full stop. This distance is a function of a person's perception (typically 2.5 s) and brake reaction time, the initial speed, the coefficient of friction between the tires and the bikeway surface, the braking capability of the bicycle, and the grade of the bikeway. Refer to TAC GDG Section 5.5.2 for guidance on determining minimum stopping sight distances for people riding bicycles.

**Table 3.23** Stopping Sight Distance for Passenger Cars

Design Speed (km/h)	Stopping Sight Distance by Grade (m)						
	-9%	-6%	-3%	0	3%	6%	9%
20	20	20	20	20	19	18	18
30	35	35	32	35	31	30	29
40	53	50	50	50	45	44	43
50	74	70	66	65	61	59	58
60	97	92	87	85	80	77	75
70	124	116	110	105	100	97	93
80	154	144	136	130	123	118	114

(Adapted from TAC GDG Tables 2.5.2 and 2.5.3, for brake reaction time of 2.5 s, deceleration rate of 3.4 m/s<sup>2</sup>, and a passenger car.  
NOTE: SSD for trucks are longer than those provided below and should be calculated based on guidance from TAC GDG Section 2.5.3.)

## INTERSECTIONS (CONT.)

### 3.6

#### Clear Sight Triangles

Sight distance at intersections is defined by the clear sight triangles. The dimensions of the legs of the sight triangles depend on the Design Speeds of the intersecting streets and the type of traffic control used at the intersection. These dimensions are based on observed behaviour of people driving and are documented by space-time profiles and speed choices. In intersection design, there are two types of clear sight triangles: approach sight triangles and departure sight triangles.

Each quadrant of an intersection should contain a triangular area free of obstructions that might block an approaching person's view of potentially conflicting movements. The length of the legs of this triangular area should be such that people driving, walking and wheeling, or cycling can see any potential conflicts with other street users with sufficient time to slow or stop before colliding. Obstructions include parked vehicles,

landscaping, buildings, monuments, utility boxes, and any objects with vertical presence that restrict people's line of sight.

The following section highlights the key sight triangles for consideration at intersections. Refer to TAC GDG Section 9.9.2 for details on determining the appropriate sight distances and sight triangles to provide. Appropriate sight distances need to consider several factors including but not limited to Design Speed, intersection control type, eye height of people travelling, object height, type of maneuver, Travelled Way widths, median treatment, and street right of way.

#### Approach Sight Triangles for People Driving

Figure 3.47 shows typical clear sight triangles to the left and to the right for a person approaching an uncontrolled or yield-controlled intersection (i.e., travelling along the "minor street" approaching the intersection with the "major street").

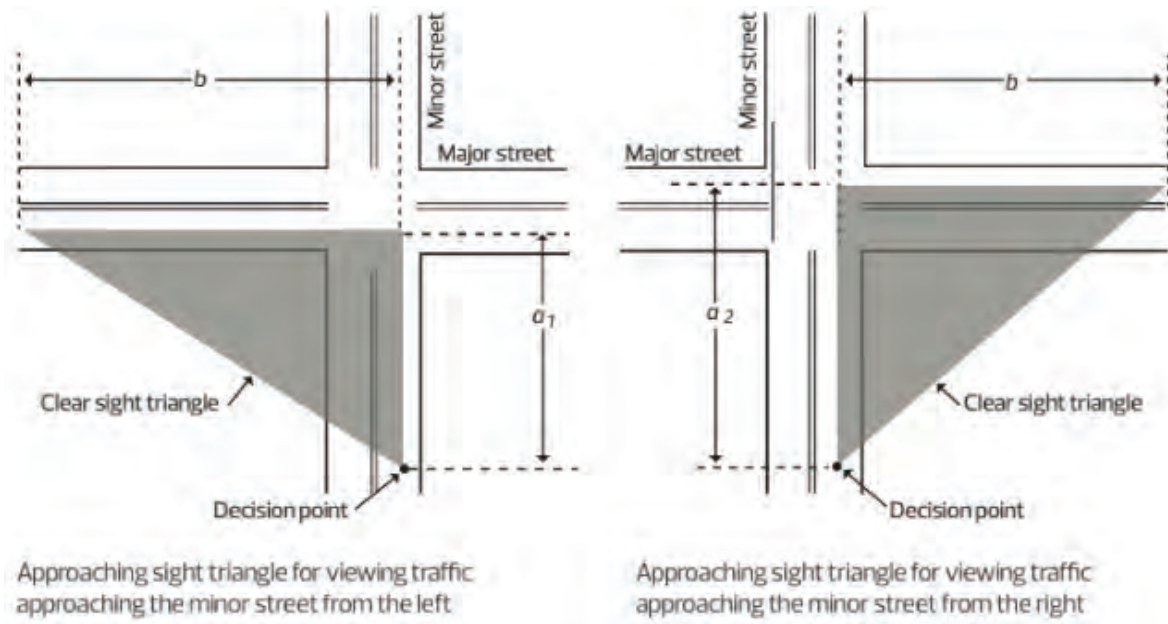

Figure 3.47 Approach Sight Triangle (Yield-Controlled) (Adapted from TAC GDG Figure 9.9.1)

## INTERSECTIONS (CONT.)

### 3.6

**Table 3.24** provides the minimum sight distance (or clear approach space, *b* in **Figure 3.47**) required at various posted speed between a person in a vehicle travelling on a minor street approaching an intersection and vehicles travelling on the major street. The clear approach space provides the person travelling on the minor street adequate time to make a decision on whether or not to brake to a stop or proceed through the intersection. Obstructions should be restricted within the clear approach sight triangle to ensure adequate sightlines.

The distance  $a_1$  represents  $a_1$  the distance from the person in a vehicle approaching on a minor street to the middle of the curbside travel lane along the major street at which point a decision to brake must be made. The distance  $a_2$  represents the distance  $a_1$  plus the width of the lane(s) departing from the intersection on the major street to the right of the approaching driver. Distance  $a_2$  should also include the width of any median present on the major street unless the median is wide enough to permit a vehicle to stop before entering or crossing the Travelled Way beyond the median. Providing a clear sight triangle also allows the user on the major approach with the right of way to react appropriately should users on the minor approach not stop.

**Table 3.24** Minimum Sightline Distance for Approach Clear Sight Triangle

Design Speed (km/h)	Minimum Sightline Distance, <i>b</i> (m)
<30	Approach sight triangles do not apply in these cases. For locations where speeds are less than 20 km/h (e.g., alleys), people driving are to exercise reasonable judgement and proceed only when safe to do so, yielding the right of way to motor vehicle, cycling, and walking/wheeling traffic.
30	70
40	90
50	115
60	135
70	160
80	180

(Adapted from TAC GDG Table 9.9.10, for intersection approach grades  $\leq 3\%$  based on passenger car making a left or right turn at a yield controlled intersection)

Approach sight triangles, like those shown above, are not used for intersection approaches controlled by stop signs or traffic signals as the approaching person's need to stop is determined by the traffic control devices and not by the presence or absence of people travelling on the intersection approaches. For stop and signal controlled intersections, the clear sight triangle is based on the departure sight triangle.

## INTERSECTIONS (CONT.)

### 3.6

Yield controlled approaches generally need greater sight distance than stop controlled approaches. If sight distance sufficient for yield control is not available, use of a stop sign instead of a yield sign should be considered. Departure Sight Triangles for People Driving

The departure sight triangle provides sight distance sufficient for a person driving, walking and wheeling, and cycling that is stopped on a minor street approach to depart from the intersection and enter or cross the major street.

Figure 3.48 shows typical departure sight triangles to the left and to the right of the location of a person stopped in a vehicle on the minor street. Departure sight triangles should be provided in each quadrant of each intersection approach controlled by stop or yield signs, and for all uncontrolled approaches (although approach sight triangles will likely control the clear sight triangle for yield and uncontrolled intersections). While departure sight triangles are not required at signalized intersections, they are beneficial as they allow the users with the right of way adequate time to slow, stop, or avoid users traveling without the right of way on the minor approach, or when traffic signals are not operational.

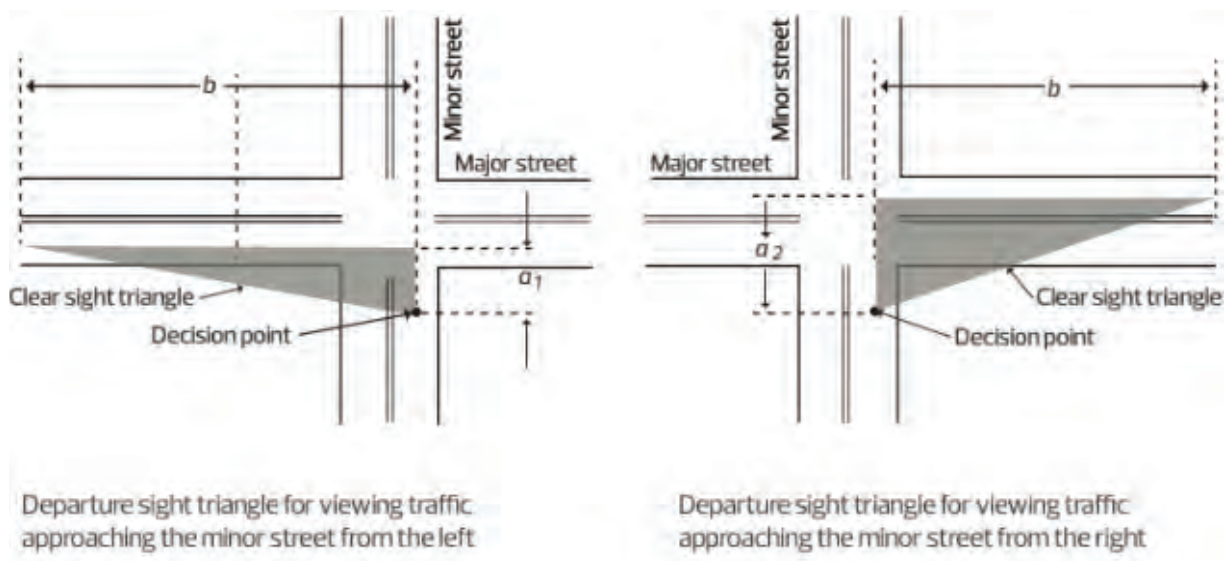

Figure 3.48 Departure Sight Triangles (Stop-Controlled) (Adapted from TAC GDG Figure 9.9.2)

## INTERSECTIONS (CONT.)

### 3.6

**Table 3.25** provides the minimum sight distance (or clear approach space, *b* in **Figure 3.48**) required at various Design Speeds between a person stopped in a vehicle on a minor street approach and drivers travelling on the major street, such that the person stopped is safely able to depart from the intersection and enter or cross the major street. The distance *a*<sub>1</sub> represents the distance from where the person is stopped in a vehicle on the minor approach to the middle of the curb side travel lane. The distance *a*<sub>2</sub> represents distance *a*<sub>1</sub> plus the width of the lane(s) departing from the intersection on the major street to the right. Distance *a*<sub>2</sub> should also include the width of any median present on the major street unless the median is wide enough to permit a vehicle to stop before entering or crossing the Travelled Way beyond the median.

**Table 3.25** Minimum Sightline Distance for Approach Clear Sight Triangle

Design Speed (km/h)	Minimum Sightline Distance, <i>b</i> (m)
30	65
40	85
50	105
60	130
70	150
80	170

(Adapted from TAC GDG Table 9.9.4, for intersection approach grades ≤ 3% and based on passenger car)

#### Clear Sight Triangles for People Cycling

Clear sight triangles associated with bicycle facilities, particularly protected bike lanes, are important to ensure visibility of people cycling at conflict points with turning or crossing motor vehicle traffic. Due to their placement on-street, the clear sight triangles in these contexts are controlled by sight distance requirements for motor vehicle traffic outlined above. For intersections of off-street shared pathways or bike paths, clear sight triangles of 3 m to 6 m should be provided at all crossings/intersections.

#### Clear Sight Triangle Size

The size of the clear sight triangles is based on the sight distances for the approach and departure sightlines and selecting the value based on intersection control type (e.g., stop control). While sight distances can be calculated for all modes of transportation, most street designs are controlled by the sight distance of users operating vehicles due to their higher speed of travel, and thus greater required stopping and decision sight distances.

Refer to TAC GDG Section 9.9.2.3 for guidelines on determining the clear sight triangle area based on the intersection traffic control type. Sight triangles for oblique (less than 60 degrees) angled intersections are described in TAC GDG Section 9.9.2.4.



## INTERSECTIONS (CONT.)

### 3.6

#### 3.6.2 Corner Radius

##### 3.6.2.1 Introduction

The corner radius is constructed to connect the curbs of two intersecting streets. The design of corner radii is influenced by the following elements:

- + Design Vehicle(s) (and Control Vehicle in some cases);
- + Turning traffic volumes;
- + Street type;
- + Lane widths;
- + Parking lane widths;
- + Total pavement (Travelled Way) widths;
- + Angle of intersection;
- + Turning condition (stop or yield);
- + Turning speed;
- + Existing and proposed drainage facilities;
- + Degree of activities and volume of people in the Pedestrian Through Zone and public realm areas;
- + Bicycle facility types and widths; and
- + Right of way restrictions.

Corner radii also impact people walking and wheeling by Influencing:

- + Available queuing space at intersections;
- + Crossing distance;
- + Crossing directness;
- + Location, number, and type of curb ramps;
- + Sightlines and visibility of and for people walking and wheeling in the non-Travelled Way; and
- + Speed of turning motor vehicles.

Corner radii should be designed using the minimum vehicle turning path of the Design Vehicles to reduce the speed of vehicle turns. Smaller corner radii provide more queuing space for people walking and wheeling, facilitate a shorter crossing distance, enable straight and direct connections, and increase the visibility of pedestrians. When selecting smaller curb radii, consideration must be given to ensure adequate drainage can be provided around the corner and snow clearing operations are accommodated. Catchbasins shall be located without interfering with curb ramps, and desired crossings can be accommodated. The design of corner radii may differ for each situation, with vehicle turning path software used to assist in, and verify, the design.

There are typically three types of curves used in intersection design: circular (simple) curves, two-centred compound curves, and three-centred compound curves, as detailed in TAC GDG Sections 9.13.2.2, 9.13.2.3, and 9.13.2.4

In general, compound curves are more appropriate for intersections which are frequently used by larger vehicles, such as the WB-21 and WB-36, such as in Industrial Areas. Circular curves are more common for non-Industrial Area intersections, in street oriented contexts, and where there are constrained rights of way.

## INTERSECTIONS (CONT.)

### 3.6

#### 3.6.2.2 Design Principles & Requirements

Design Vehicles are used in determining the appropriate corner radius, as discussed in Section 3.1.3.3. An intersection is typically designed to accommodate the Design Vehicle, and the Design Vehicle should be able to maneuver the intersection without encroaching into opposing lanes; however, in constrained locations, encroachment into opposing lanes may be required and an advanced stop bar should be used. A Control Vehicle is the largest vehicle type required to maneuver the intersection, but occurs at relatively low frequency, and may encroach into adjacent and opposing lanes.

The following Design Vehicle and Control Vehicle principles should be applied when developing corner radii:

- +

  - Vehicle turning speeds of 5 km/h should be used for Control and Design Vehicles of greater than 11.0 m in length and 5 to 10 km/h should be used for vehicles shorter than 11.0 m. Fire Truck turning speeds should be 10 to 15 km/h. Lower vehicle speeds can be used for constrained conditions at the discretion of the City.
  - Vehicle starting position should have a minimum 0.3 m offset from face of curb/centre of lane marking on the right side.
  - Vehicle turning movements must maintain a minimum 0.3 m offset from face of curb during the turning manoeuvre. This may be reduced at the discretion of the City where there are no pedestrian facilities immediately adjacent to the curbline.
- +

  - Design Vehicles should not cross the centreline of the intersection approach on arterial streets, but may use multiple receiving lanes with the same travel direction, depending on the traffic volume on the street and traffic controls.
  - Design Vehicles may encroach partway into opposing traffic lanes on low volume local and collector streets, where daily traffic is less than 2,000 vehicles per day. If no painted centreline exists, Design Vehicles may use the entire Travelled Way outside of designated parking zones. If intersections are stop controlled, and adequate sightlines can be provided, vehicles on the receiving approach must have adequate setback for the stop line to minimize conflicts with turning vehicles.
  - An advanced stop bar should be installed where the Design Vehicle encroaches into opposing lanes of traffic at a signalized intersection. This is more likely to occur in constrained rights of way such as Main Streets.
  - Dual left and right turn lanes must be designed to accommodate side by side maneuvers by the design vehicle.
  - Emergency vehicles must be able to physically maneuver between fixed objects and parked vehicles on all corners, but are allowed to use the entire pavement width.
  - Where possible, symmetrical designs should be used in the same intersection for consistent user expectations and to allow maneuvering of the Design Vehicle in all directions.

## INTERSECTIONS (CONT.)

### 3.6

- + Intersection corners with full time 'no right turn' restrictions do not need to accommodate right turning vehicles.
- + All vehicles shall be able to maneuver turns without coming into conflict with legally parked vehicles.
- + When a right turning lane is not adjacent to the curb, the effective turning radius can be greater than the physical radius. This can occur where there are painted bike lanes or on-street parking at an intersecting street. The effective turning radius shall be used for maneuvering, and a smaller physical corner radius should be constructed, as shown in Figure 3.49 below.

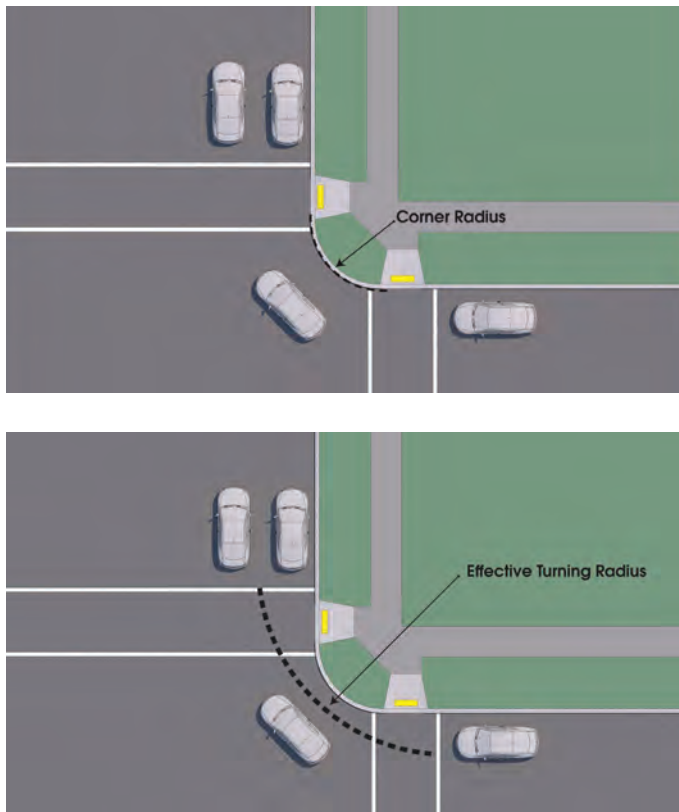

Figure 3.49 Corner Radii and Effective Turn Radius

## INTERSECTIONS (CONT.)

### 3.6

Design Domain dimensions for corner radii are included in **Tables 3.26** and **3.27** for varying intersection types based on the Design Vehicle for intersections in non-Industrial and Industrial Areas, respectively. Corner radii shall be confirmed through the use of swept path analysis to ensure the Design Vehicle can navigate the proposed design. All radii are navigable by snow clearing equipment. Refer to **Table 3.1** (Section 3.1.3.3) for a complete summary of the Design and Control Vehicles by street classification. For arterial streets with Design Speeds over 50 km/h that intersect with arterial or collector streets, two-centred, three-centred, and channelized right turns may be more appropriate. See Section 3.6.8.1 for factors and design considerations for channelized right turns.

**Table 3.26** Design Domain: Intersection Corner Radii (in m)

Parameter: Intersection Corner Radii (Departing Street/Receiving Street)	Design Vehicle	Control Vehicle	Design Domain Recommended Range <sup>1</sup>		Design Target Value <sup>2</sup>
			Recommended Lower Limit	Recommended Upper Limit	
<b>Arterial Truck Route/Arterial Truck Route<sup>3</sup></b>	WB-21	WB-36	Use High Entry Angle channelized right turn design		
<b>Arterial Truck Route/Arterial Non-Truck Route<sup>3,5</sup></b>	B-12	WB-21	7.5	15.0	8.0
<b>Arterial Truck Route/Collector</b>	B-12	WT, FT	10.0	15.0	10.0
<b>Arterial Non-Truck Route/Arterial Truck Route<sup>3,5</sup></b>	B-12	WB-21	7.5	15.0	8.0
<b>Arterial Non-Truck Route/Arterial Non-Truck Route<sup>3,5</sup></b>	B-12	WB-21	7.5	15.0	8.0
<b>Arterial Non-Truck Route/Collector</b>	B-12	WT, FT	10.0	15.0	10.0
<b>Collector/Arterial Truck Route<sup>3</sup></b>	B-12	WT, FT	7.5	10.0	8.0
<b>Collector/Arterial Non-Truck Route<sup>3</sup></b>	B-12	WT, FT	6.5	10.0	7.0
<b>Collector/Collector</b>	B-12	WT, FT	7.5	10.0	8.0
<b>Main Street/Any Street,<sup>6,7,8</sup> OR Any Street/Main Street</b>	MSU	B-12	4.5	10.0	6.0
<b>Local/Any Street OR Any Street/Local</b>	P	WT, FT, MSU	4.0	6.0	4.0

**Notes:**

- Designers should use corner radii toward the lower end of the Design Domain if the design target value is not used, however, turning maneuvers must be confirmed using swept path analysis for the Design and Control Vehicle
- Target value is based on typical street cross sections as shown in the Standard Details. Swept path analysis is required to confirm corner radius based on the Design Principles. Where a corner is utilized by a bus, and the total width of the receiving lanes is less than 6.0 m, a two centred R9 + R70 curve shall be used.
- All arterial street receiving lane scenarios based on two receiving lanes along the arterial street and a median. If more than two lanes are provided, a corner radius lower than the Design Domain recommended lower limit is possible, but must be confirmed using swept path analysis.
- When along a Main Street or inside the Mature Neighbourhood Overlay, review simple or multi-centred radius curves with the objective to minimize crossing distances for people walking.

## INTERSECTIONS (CONT.)

### 3.6

5. Where there is a raised or depressed centre median, a simple radius may not accommodate the Control Vehicle. Complete swept path analysis to confirm vehicle turning movements. The use of a High Entry Angle channelized right turn may be required.
6. See City's MSG for more information on corner radii guidance for Main Streets. Use of higher radii on Main Streets should be rationalized and documented via a design exception.
7. A B-12 design vehicle should be utilized where bus movements are expected and may require adjustment to curb radii depending on the number of receiving lanes.
8. Where the receiving street has a single 3.0m lane and encroachment into oncoming lanes is not desirable for the MSU design vehicle, a R7.5 + R50 two-centred curve may be used.

**Table 3.27** Design Domain: Intersection Corner Radii – Industrial Areas (in m)

Parameter: Intersection Corner Radii (Departing Street/Receiving Street) <sup>1</sup>	Design Vehicle	Control Vehicle	Design Domain Recommended Range <sup>2</sup>		Design Target Value <sup>3</sup>
			Recommended Lower Limit	Recommended Upper Limit	
<b>Arterial Truck Route/Industrial Area Collector</b>	WB-21	WB-36	Use High Entry Angle channelized right turn design		
<b>Arterial Truck Route/Industrial Area Local</b>	WB-21	WB-36	Use High Entry Angle channelized right turn design		
<b>Industrial Area Collector/Arterial Truck Route<sup>4</sup></b>	WB-21	WB-36	Use High Entry Angle channelized right turn design		
<b>Industrial Area Collector/Industrial Area Collector</b>	WB-21	WB-36	11.5	15.0	12.0
<b>Industrial Area Collector/Industrial Area Local</b>	WB-21	WB-36	14.0	15.0	15.0
<b>Industrial Area Local/Arterial Truck Route<sup>4</sup></b>	WB-21	WB-36	Use High Entry Angle channelized right turn design		
<b>Industrial Area Local/Industrial Area Collector</b>	WB-21	WB-36	12.5	15.0	13.0
<b>Industrial Area Local/Industrial Area Local</b>	WB-21	WB-36	15.0	15.0	15.0

**Notes:**

1. Arterial street/arterial street intersection Design Domain is provided in **Table 3.26**.
2. Designers should use corner radii toward the lower end of the Design Domain if the design target value is not used, however, turning maneuvers must be confirmed using swept path analysis for the Design and Control Vehicle.
3. Target value is based on typical street cross sections as shown in the Standard Details. Swept path analysis is required to confirm corner radius based on the Design Principles.
4. All arterial street receiving lane scenarios based on two receiving lanes along the arterial street and a median. If more than two lanes are provided, a corner radius lower than the Design Domain recommended lower limit is possible, but must be confirmed using swept path analysis.

## INTERSECTIONS (CONT.)

### 3.6

#### Mountable Curbs

As discussed in Section 3.2., mountable curbs can be used in areas where there is a need to accommodate infrequent large trucks. The inside curb radius is designed to accommodate the larger Control Vehicle turning template (or Design Vehicle that is less frequent), while the outside curb radius is designed to accommodate the Design Vehicle. The area between the two curb radii can be constructed as a mountable curb apron.

**Figure 3.50** shows examples of using mountable curbs for extension of corner areas, and how to transition the curb ramps (see Section 3.6.3) across the curb extension. The design requires two curb ramps to

transition down to street level, but the curb ramp transitions would be more gradual than regular curb ramps. The curb side ramp would transition from full curb height (e.g., 150 mm) down to the back of the mountable apron area. The height would vary depending on the width of the curb extension. A minimum cross slope of the apron area is 0.02 m/m towards the street, with the mountable rolled curb height of 80 mm. The second lower curb ramp would transition from the back of the apron area down to the Travelled Way. Additional measures should be installed for Universal Design. A Tactile Walking Surface Indicator should be installed on the first ramp. Crosswalk markings should be painted, or a different surface treatment used through the lower curb ramps, to ensure people do not use the mountable apron as a waiting area.



(Source: Central Seattle Greenways)

The City of Edmonton has been piloting coloured concrete aprons using egyptian red and a pinwheel brick pattern to delineate the raised apron. A detail is provided for reference on drawing #3130. Other jurisdictions within Alberta have been using similar colors in between dark red and brown earth tones.



(Source: Google Maps)



(Source: Google Maps)

**Figure 3.50** Mountable Curb Treatment Examples

## INTERSECTIONS (CONT.)

### 3.6

#### 3.6.3 Curb Ramps & Tactile Walking Surface Indicators

A curb ramp is a graded transition between the Pedestrian Through Zone (e.g., sidewalk) and the Traveled Way, linking the Pedestrian Trough Zone with the crosswalk and ensuring a smooth transition for all users. A curb ramp consists of several parts that provide smooth transitions, places of refuge, and tactile guidance for people walking and wheeling who may have a visual impairment or are using mobility aids. The shape and positioning of these elements varies according to curb ramp type and geometric constraints. The parts are illustrated in *Figure 3.51* and include:

- + Ramp – the transitional grade between two surfaces (typically a sidewalk and a street crosswalk);
- + Landing – a fat surface at the top of a curb ramp that provides a space for refuge and maneuvering;
- + Flare – the sloped edge between the ramp and the adjacent sidewalk. A flare is not an ideal travel surface for a wheelchair user, but provides a flexible and detectable means for people walking and wheeling to access the ramp from the side, rather than the landing;
- + Approach – the sidewalk panel(s) adjacent to the curb ramp. The approach area should be designed as fat as possible so that grades entering the curb ramp are minimized;
- + Tactile Walking Surface Indicator (TWSI) – a warning treatment that alerts people walking and wheeling to the presence of a street crossing through a tactile surface and/or contrasting colour; and
- + Hard surfaced – All the above described parts of the curb ramp should be hard surfaced and comply with requirements described in the CSA's Accessible Design for the Built Environment.

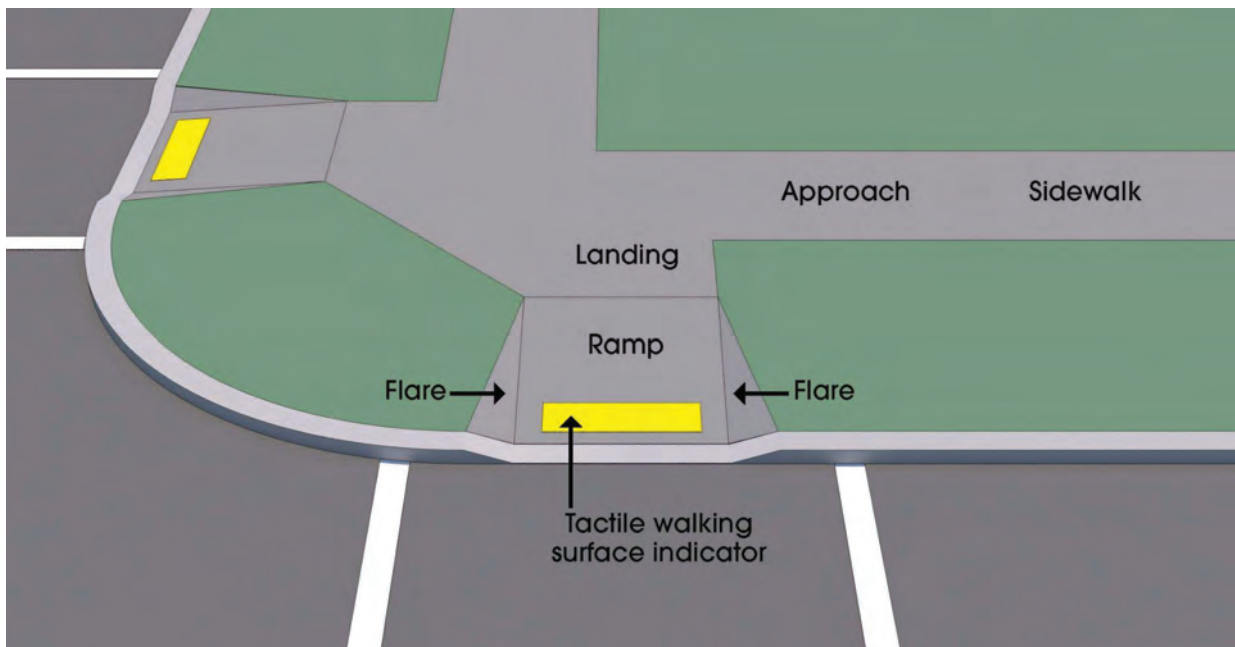

*Figure 3.51* Parts of the Curb Ramp

## INTERSECTIONS (CONT.)

### 3.6

Curb ramp design is dependent on the adjoining sidewalk design and crosswalk location and width. To ensure a Universal Design accessibility, the curb ramp and adjoining sidewalk shall adhere to the design criteria in **Table 3.28**.

**Table 3.28** Curb Ramp Design Requirements<sup>1</sup>

Design Criteria		Design Requirement
<b>Approach/ Sidewalk</b>	Cross Grade	≤ 2%
	Longitudinal Grade	≤ 5%
<b>Curb ramp</b>	Provision	At every corner and mid-block crossing
	Grade	≤ 6.0%
	Curb Ramp Flare	400 mm (separated sidewalk)/1700 mm (monowalk)
	Width (exclusive of fared sides)	1.8 m min.; should match sidewalk width
	Length	Based on grade
	Tactile Device	<p><b>Tool Grooved Concrete</b> Tool Grooved Concrete at minimum at each curb ramp along or crossings all freeway/expressway, arterial, and collector, and local streets and off-street shared pathways (e.g., paths along utility corridors) crossings with these street classifications.</p> <p><b>Truncated Domes</b> Truncated domes shall be utilized at locations with high pedestrian volumes, including main streets, pedestrian priority areas, and street oriented developments, as well as at schools, transit centres, libraries, and recreation centres.</p> <p>If using truncated domes with midblock crossings, guidance should also be provided to direct users to the crossing, a physical element perpendicular should also be considered.</p> <p>Example details 5520, 5521, 5522, 5523, 5524, 5530 and 5531 provide guidance around the use of truncated domes for curb ramps. 5530 and 5531 provide pilot examples of directionality using truncated domes and detectable guidance surface indicators.</p>
<b>Landing</b>	Width	Match curb ramp
	Length	1.8 m min. and up to 2.25 m to accommodate most wheelchair types

The following general guidance applies to curb ramps at crosswalks:

- + Curb ramps should optimally be centred in the crosswalk (i.e., the curb ramp should meet a crosswalk roughly at its centerline) so they do not project people walking and wheeling into the vehicle traffic lanes, parking spaces, or parking access aisles.
- + A2 type curb ramps should in general be avoided unless in constrained areas in retrofit situations or other geometric requirements.
- + Curb ramps should be equipped with tactile walking surface indicators (TWSIs), whether they are located at an intersection or mid-block, to make the person walking and wheeling aware they are entering a hazard area and to direct their travel through the area
- + Perpendicular curb ramps are preferred as they enhance safety and mobility for people walking and wheeling. They mitigate crowding through separation of users traveling in different directions and reduce ambiguity for drivers about which crosswalk people walking and wheeling intend to use. These ramps allow

<sup>1</sup> Based on: Transportation Association of Canada (TAC). 2017. Geometric Design Guide for Canadian Roads . Ottawa: Transportation Association of Canada; Canadian Standards Association (CSA), 2012. Accessible Design for the Built Environment. Report CSA B651-12. Mississauga: CSA Group, formerly Canadian Standards Association.



## INTERSECTIONS (CONT.)

### 3.6

wheelchair users and visually impaired people to directly enter the crosswalk rather than entering the street at an angle. They also reduce encroachment by turning motor vehicle traffic compared to a fully depressed corner.

- + Perpendicular curb ramps will not provide a straight path of travel on large radius corners. At intersections with narrow sidewalks and large corner radii, parallel curb ramps or a fully depressed curb ramp should be considered. For typical arterial/arterial intersections, this threshold occurs at a 11.0 m radius. For typical arterial/collector intersections, this threshold occurs at a 6.5 m radius.
- + Provide adequate distance between the curb ramps to allow for development of the full curb height between the curb ramps on the corner. A minimum distance of 3 m should be provided for

the tapers down to the curb ramps. A minimum of 0.5 m between the ends of two adjacent perpendicular curb ramp flares is needed to develop the full curb height. Refer to Figure 3.52 and 3.53.

- + Where increased separation exists between the crosswalk and adjacent turning lanes, additional consideration must be given to ensuring adequate sight lines for people crossing and people turning. This may necessitate “bend-in” configurations for sidewalks, or the use of depressed or parallel curb ramps.
- + Catch basins/drainage facilities should be placed outside of the curb ramp and crosswalks to the greatest extents possible.

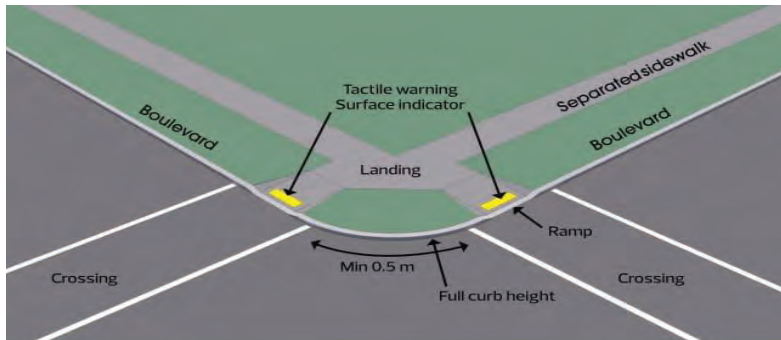

Figure 3.52 Perpendicular Curb Ramps Boulevard Separated Sidewalk

Curb ramp standard details for the City of Edmonton are shown on the standard detail drawings in Chapter 3. More information on curb ramps can be found in TAC GDG Section 6.4.6 and 6.5.2.

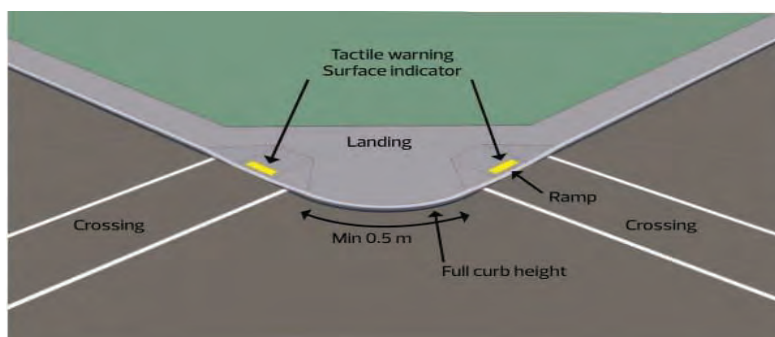

Figure 3.53 Perpendicular Curb Ramps Monolithic Sidewalk

## INTERSECTIONS (CONT.)

### 3.6

#### 3.6.4 Crossings for People Walking and Wheeling

A crossing for people walking and wheeling occurs when facilities for walking intersect with the Travelled Way or bicycle facilities, creating conflict points between people walking and wheeling and those driving and/or cycling. These conflict points occur:

- + On the street, at intersection and mid-block crossing locations (e.g., crosswalks);
- + On the sidewalk (i.e., Pedestrian Trough Zone), where driveways and alleys cross the sidewalk;
- + On bicycle facilities such as protected bike lanes at intersection and mid-block crossing locations; and
- + At bus stops.

Since people walking and wheeling are the most vulnerable street user, their design needs should promote safety and comfort by managing motor vehicle speeds, improving visibility, inter-visibility, and sightlines, reducing street crossing distance, increasing crossing directness, and providing accessible spaces.

Design principles for safe and attractive crossings for people walking and wheeling include the following:

- + Desire lines represent the shortest or most easily accessible route between the person and the attraction/destination. Crossings opportunities should be available at appropriate intervals to match the demand to cross the street along direct desire lines;
- + Crossings should be clear and visible. The location along with possible markings, materials, and illumination of the crossing should make it easily

identifiable and allow people walking and wheeling to see and be seen by traffic, both while waiting to cross and while crossing;

- + Crossings should be direct and accessible to people of all ages and abilities; and
- + Crossings should be as short as possible.

#### 3.6.4.1 Crosswalks

Crosswalks are a designated area to cross a street for people walking and wheeling, and are typically located at either an intersection or mid-block. More information on crosswalk pavement markings, signs, and signals can be found in Section 3.6.9. Information on raised crossings can be found in section 3.6.4.3.

#### Intersection Crosswalks

All intersections are legal crossing points, regardless of whether there is signage, pavement markings, or active devices indicating a crosswalk, unless the crossing is specifically prohibited by signage or as per the Traffic Safety Act. People driving should therefore expect to encounter people walking and wheeling at every intersection. Traffic controls (e.g., signs, pavement markings, signals) indicate to people driving a higher level of walking activity, and encourage people walking and wheeling to cross at designated locations. People walking and wheeling must still exercise due caution and care when crossing any street.

At signalized intersections, all crosswalks should be marked. At unsignalized intersections, crosswalk markings and signage, such as zebra and/or twin parallel line pavement markings, and warning measures such as overhead pedestrian flashers, may be used in accordance with the MUTCD-C and the TAC Pedestrian Crossing Control Guide.<sup>2</sup> Warrants to install traffic

<sup>2</sup> Transportation Association of Canada (TAC). 2012. Pedestrian Crossing Control Guide, Second Edition . Ottawa: Transportation Association of Canada.

## INTERSECTIONS *(CONT.)*

### 3.6

controls for crossings consider factors that include, but are not limited to, activity of people walking and wheeling and motor vehicle volumes, vehicle speed, street width, sightline restrictions, proximity to schools and seniors' facilities, proximity to transit stops and transit centres or stations, latent demand of people walking and wheeling, safety and operational history, and distance to the nearest alternative crossing. Decorative pavement marking treatments can also be applied to enhance crosswalk visibility and add vibrancy to the streetscape. Additional guidance on decorative crosswalks is provided in Section 3.6.9.

The components of different types of crosswalks are provided in Tables 3A through 3F of the TAC Pedestrian Crossing Control Guide. Prohibiting crossing for people walking and wheeling at an intersection leg is sometimes implemented for safety or operational reasons. This practice should only be justified based on the needs of all intersection users, and should consider negative impacts on the crossing distance and delay for people walking and wheeling. Non-compliance can be a problem when crossings are prohibited. Justification for prohibiting a crossing should be in the form of a Design Exception (see Section 2.2).

**Location for Intersection Crosswalks.** The location of crosswalk markings at intersections is impacted by corner radii (Section 3.6.2) and the width of the crosswalk which affects the type and placement of curb ramps (Section 3.6.3). **Figure 3.54** illustrates the effect of corner radius on the crossing distance and location of the crosswalk. For larger corner radii, implementation of a crossing setback would reduce the crossing distance. However, this approach should be avoided as it reduces the visibility of people crossing on the side street to the people travelling along the main street. The larger corner radii allow for higher turning speed, and combined with poor sightlines, creates an unfavourable condition for people crossing the side street.

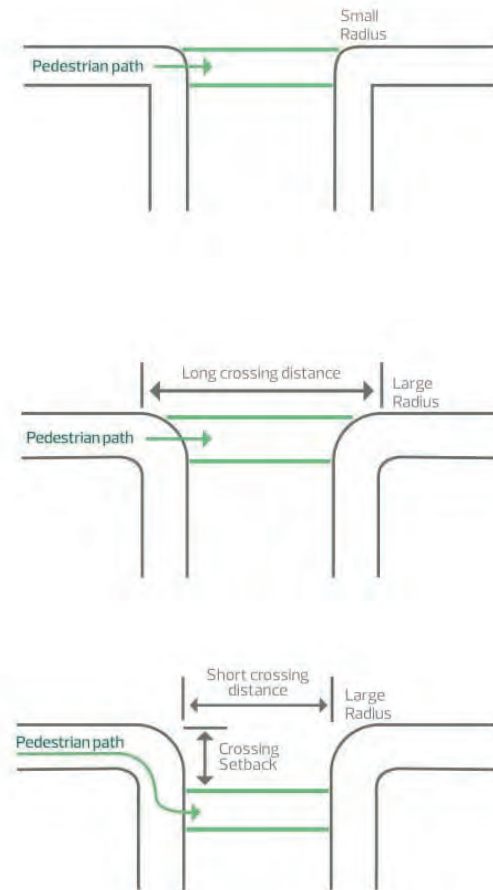

**Figure 3.54:** Effect of Corner Radius on Crossing Distance and Directness for People Walking

## INTERSECTIONS *(CONT.)*

### 3.6

The following are design considerations when determining where to locate the crosswalk. More information can be found in TAC GDG Section 6.4.5.

- ✦ Smaller corner radii decrease crossing distance for people walking and wheeling. Increased corner radius increases the crossing distance for people walking and wheeling unless the crosswalk location is set back further from the intersection, which affects crossing directness and visibility;
- ✦ The intersection side of a typical crosswalk should initially be offset a minimum of 0.6 m from the face of the parallel street curbline. The crosswalk can then be moved around the curb return as necessary to achieve a balance of crossing distance and directness;
- ✦ The curb ramps should be centred in the crosswalk; and
- ✦ If within the crosswalk, a raised island shall have a level area in the middle to accommodate refuge based on Universal Design or the median can be ended prior to the crosswalk and have a median tip to protect the refuge area. See Section 3.2.5 for guidance on refuge area size requirements.

#### *Mid-Block Crosswalks*

Mid-block crosswalks legally establish right of way for people walking and wheeling at a mid-block location and are often associated with connecting a shared-use path across a street or in street oriented commercial contexts. Other locations where mid-block crossings may be considered include arterials streets with block lengths of more than 200 m with key destinations

on either side of the street, access points to major community destinations, where there is a history of collisions for people walking and wheeling, and locations with heavy volumes of people walking and wheeling (e.g., adjacent to mid-block transit stops). At the discretion of the City, mid-block crossings on collector and local streets may occur at closer intervals than arterial streets.

An engineering study should be completed on arterial streets to determine if a mid-block crossing is warranted. Factors to consider include vehicular volumes and speeds, street width and number of lanes, stopping sight distance and sightlines, distance to the next controlled crossing, night-time visibility, grade, origin-destination of trips, volume of people walking and wheeling, and latent demand for people walking and wheeling.

The engineering study will indicate whether signage and pavement markings are sufficient or if active traffic control is required (e.g., traffic signals or amber flashing beacons) and should consider Vision Zero as a primary objective. Details on conducting a crosswalk engineering study are found in the TAC Pedestrian Crossing Control Guide.

#### **3.6.4.2 Crosswalk Enhancement Measures**

Design elements can be implemented at intersection and mid-block locations to enhance operations and safety for people crossing, such as curb extensions, raised crossings, and refuge areas. See Section 3.6.4.3 for design guidance on raised crossings, and Section 3.2.5 for design guidance on median refuge areas. More information on the other design elements, which can serve the dual function of calming traffic, can be found in Section 3.8.

## INTERSECTIONS (CONT.)

### 3.6

#### 3.6.4.3 Raised Crossings

##### Introduction

Raised crossings are a vertical deflection that raises the roadway to meet the height of a crossing, creating a continuous level surface for people walking, wheeling or cycling. Raised crossings consist of two ramps and a flat crossing surface.

Raised crossings may be used to achieve any of the following objectives:

- + Indicate priority of pedestrians and cyclists
- + Indicate entrances/exits to residential areas
- + Reduce speeds at conflict locations such as marked crosswalks, school crosswalks and pathway crossings
- + Reduce speeds in conjunction with an overall traffic calming strategy for a corridor or neighbourhood and/or,
- + Increase crossing accessibility and comfort by eliminating ramps and reducing accumulation of water, slush and snow in crossings

Raised crossings improve safety for people walking, rolling and biking by increasing driver awareness of people crossing and decreasing driver speeds. This gives drivers the benefit of a longer reaction time and reduces collision severity, should a collision occur.

##### Application

This section provides guidance on selection of appropriate raised crossings and evaluation of suitability of the use of raised crossings. The following conditions should be reviewed when considering the suitability of a site for a raised crossing:

##### Street Type

- + **Land Use** – Near residential, mixed-use, or commercial development, post-secondary institutions, schools, transit hubs, or other areas with high pedestrian or cyclist activity, especially seniors and other vulnerable users.
- + **Number of Lanes** – 2 or fewer through lanes in each direction along the roadway.
- + **Speed** – Posted Speed is 50 km/hr or less, with priority at transitions between speed zones.
- + **Volume** – Daily motor vehicle traffic volumes are less than 20,000 vehicles per day.
- + **Heavy Vehicles** – The proportion of motor vehicle traffic has a mix of 5% or less heavy vehicles including buses.
- + **Grade** – The longitudinal grade of the roadway is 8% or less.

##### Functional Classification

- + **Arterial** - Along Downtown arterials, Main Streets, arterials with speeds 50 km/h or less, or arterials with low heavy vehicle volumes. Raised crossings are not typically appropriate across arterials.
- + **Collector & Local** – along or across Mixed-Use and Residential Collector or Local Roadways.
- + Alleys/Driveways, Reverse Housing Alleys and Pedestrian Only Streets & Shared Spaces.

##### Modal Priority

- + **Pedestrian and Cyclist Priority** - Where people walking and cycling have higher modal priority, such as around, but not limited, to Nodes and Corridors in the *City Plan*, in Transit Oriented Development areas and along District Connector bike routes in the *Bike Plan*.
- + **Safety** - Where a pattern of low compliance or collisions between drivers and pedestrians or cyclists exist or is expected to occur.

## INTERSECTIONS (CONT.)

### 3.6 Selection

#### Raised Mid-Block Crossings

Raised mid-block crossings can be used to reduce the approach speed of people driving at a specific conflict location between intersections and increase awareness of a mid-block crossing. They may also be applied as part of a larger traffic calming strategy along a corridor.



Figure 3.55: Raised Midblock Crossing<sup>3</sup>

- + **Street Context** – At mid-block crossings across Local and Collector roadways, Reverse Housing Alleys and Shared Roadways. Across other roadways with design speeds less than 50 km/h where context is appropriate
- + **Crossings for People Cycling** - mid-block pathway crossings, particularly where paths are located in their own right-of-way
- + **Crossings for People Walking and Wheeling** - mid-block school or playground crosswalks, or other locations where higher volumes of children, seniors or other vulnerable users are present
- + **Traffic Calming** – Apply as part of an overall traffic calming strategy to lower speeds along a corridor or neighbourhood, or as an entry treatment to a lower speed zone such as a playground zone

#### Raised Crossings at Intersections

Raised crosswalks may be used at intersections where a set-back crossing is used, where pedestrians and/or cyclists have priority at an intersection, and where the intersecting roads have equal priority (i.e. similar traffic function), where a typical continuous crossing is not feasible, or as part of a larger traffic calming strategy.

Set-back continuous crossings are built using the same detail as raised crossings, but should use materials to visually communicate pedestrian and cyclist priority.



Figure 3.56: Raised Crossing at Intersection<sup>3</sup>

- + **Street Context** – Residential Local and Collector roadways, Reverse Housing Alleys and Shared Roadways. Along arterial and collector roadways with bike facilities.
- + **Crossings for People Cycling** - Setback crossings are preferable for two-way cycle facilities, including shared pathways and two-way bike paths. A target setback of 5 m, or 0-2 m, should be used. For one-way bike facilities, setback raised crosswalks may be used when continuous crossings are not feasible.
- + **Crossings for People Walking and Wheeling** - at school or playground crosswalks, or other locations where higher volumes of children, seniors or other vulnerable users are present
- + **Traffic Calming** – Apply as part of an overall traffic calming strategy to lower speeds along a corridor or neighbourhood, or as an entry treatment to a lower speed zone such as a playground zone

<sup>3</sup> Source: NACTO Urban Street Design Guide

## INTERSECTIONS (CONT.)

### 3.6

#### Continuous Crossings

Continuous Crossings should be used along a corridor as a gateway treatment into a residential area and to clearly emphasize pedestrian and cyclist priority along a corridor through materials and grading. Continuous crossings minimize conflict between road users by encouraging better yielding behaviour and slower speeds entering and exiting a side street across a walking and or cycling facility.



Figure 3.57: Continuous Crossing

- + **Street Context** - Along Downtown Arterial Streets, Main Streets, and Mixed-use and Residential Collector Streets where residential local and collector roads meet the major roadway.
- + **Crossings for People Cycling** - For raised cycle facilities where cyclists have clear priority over the side street and the side street is controlled by a stop or yield condition. Continuous crossings are preferred for one-way bike facilities, and only used for two-way bike facilities when setback raised crossings are not feasible.
- + **Crossings for People Walking and Wheeling** - Along corridors with higher walking priority, such as along Downtown arterial streets and Main Streets, at school or playground crosswalks, or other locations where higher volumes of children, seniors or other vulnerable users are present

#### Raised Intersections

In locations that are suitable for both raised crossings along and across a corridor or where intersection operations are more complex, a raised intersection may be considered. This may include:

- + As traffic calming, where roadways of equal priority meet.
- + Where multiple legs of an intersection would benefit from from a raised crossing, such as where the primary pedestrian movement is across multiple legs of the intersection
- + Where intersection operations and more caution is desirable, such as where a bike facility transitions into another facility



Figure 3.58: Raised Intersection<sup>3</sup>

#### Design Elements

##### Crossing Width

The absolute minimum crossing width is 2.5m. The width of the flat crossing surface should match the width of the crosswalk or incoming walking and/or cycling facilities when they are wider than 2.5m. 4.0m is the target for most crossings.

##### Vehicle Ramps

Vehicle ramp design is one of the most challenging and critical elements in implementing an effective raised element. Ramp grades are influenced by the design speed, traffic control, surrounding curb height and incoming grades. The target grade breaks between the roadway, table-top and ramp are found in [Table 3.29](#) and [Table 3.30](#). The grade breaks and ramp length have been chosen to achieve an equivalent height of 80-125mm. These are a starting point for

## INTERSECTIONS (CONT.)

### 3.6

the designer and the overall interaction between crossing width, slope of approaches, context of the area, and desired operational characteristics of all users need to be considered.

**Table 3.29** Design Domain: Raised Crosswalks and Intersections - Ramp Length and Grade Break

Parameter: Design Speed (km/h)	Design Domain Recommended Range <sup>1</sup>		
	Lower Limit	Upper Limit	Target <sup>2</sup>
Ramp Length	1.75	2.75	1.75
Grade Break	4.0%	7.5%	6.25%

**Note:**

1. On frequent transit routes or where high volumes of truck traffic are present, a 5.75% grade break is recommended with a maximum grade break of 6.25%.
2. Target design speed is 40 km/h. If a higher design speed is selected, increasing the ramp length and/or reducing the grade break is required.

**Table 3.30** Design Domain: Continuous Crossings - Ramp Length and Grade Break

Parameter: Design Speed (km/h)	Design Domain Recommended Range		
	Lower Limit	Upper Limit	Target <sup>1</sup>
Ramp Length	0.8	1.0	0.8
Grade Break	10%	16.5%	12.5%

**Note:**

1. Target design speed is 5 km/h, which is consistent with a stop or yield control. If a higher design speed is selected, increasing the ramp length and/or reducing the grade break is required.

#### Effective Radius

For raised crossings at intersections, the design radius should match the design radii and design vehicles in 3.6.2.2. For continuous crossings, the standard detail accommodates the Design and Control vehicles for a Local Street intersection. The extent of the reinforced area and pan may need to be adjusted to accommodate larger design vehicles and should be confirmed using swept path analysis.

#### Accessibility

The crossing surface of the raised crossing is considered part of the sidewalk and/or cycling facility and should meet the horizontal and vertical grade design standards for pedestrian and cycling facilities provided in section 3.5.7 of the Complete Streets Design and Construction Standards

#### Tactile Walking Surface Indicators (TWSI)

A tactile warning to alert people walking and wheeling that they are entering a street crossing is required at all raised crossings. See the City of Edmonton Access Design Guide for more information.

#### Pavement Marking & Signage

Raised crossings that are not controlled by a stop or yield sign must be marked by a WA-50 bump sign. Additional signage to indicate crossings for pedestrians and/or cyclists (pedestrian crossing, bicycle crossing, pedestrian and bicycle crossing, etc.) may supplement the crossing location.

Crosswalk and crossride markings are not required at all raised crossings but may be installed in accordance with the MUTCD-C and the TAC Pedestrian Crossing Control Guide.

Warning markings ('shark's teeth') are placed on the ramps at all asphalt raised crossings, and concrete crossings with a posted speed greater than 40 km/h.

Due to the poor adhesion of pavement markings on concrete, pavement markings may be placed on the asphalt in advance of the raised crossing.



## INTERSECTIONS *(CONT.)*

### 3.6

#### *Drainage*

Generally raised crossings require new drainage infrastructure on one or both sides of the crossing depending on incoming road grades. Proximity to drainage tie-ins should be considered to avoid excessive drainage costs.

Where applicable, water may be directed across the side-street along continuous crossings, with a single catch basin located on the up-stream side. Catch basins should also be located outside of the perpendicular curb ramps and flares.

#### *Materials*

Materials for raised crossings may be either concrete or asphalt or a combination of the two. For continuous crossings, the crossing materials should match the intersecting walking or cycling facilities to visually indicate priority of active modes over the side street.

Use of stamped concrete or pavers may have an impact on accessibility, maintenance and noise and should be considered carefully before selection. Tinted concrete may be used as a decorative treatment or to delineate the

#### *Additional Considerations*

Raised crossings delay the response speeds of Emergency Services. Use of raised crossings near hospitals and fire stations should involve consultation with Emergency Medical Services and Fire Rescue Services. Removing raised crossings or adjusting to have gentler ramp grades and/or longer table tops may be considered.

Raised crossings should be avoided on longitudinal grades over 8%. Special consideration should also be given to the proximity of or on a horizontal (minimum horizontal radius of 100 m for locating on a horizontal curve) and vertical curves and availability of good sightlines.

On higher speed roadways, high traffic volume roadways, or vehicles with high volumes of right turning vehicles, consideration should be given to traffic operations and overall safety resulting from the reduced turning speed of vehicles from the primary roadway onto the secondary roadway.

## INTERSECTIONS (CONT.)

### 3.6

#### 3.6.5 Crossings for People Cycling

Intersections are areas of potential conflict and can be challenging to navigate by bicycle. Designing intersections requires careful consideration of the inter-visibility of people cycling and driving, isolating and managing conflicts upstream of the intersection area, and clearly assigning yield priority. The following sections identify intersection treatments for bicycle crossings based on the type of bicycle facility provided on the street. In some cases, the bicycle facility may change at the intersection (i.e., to provide more separation) to manage conflicts and improve safety.

Accommodation of bicycle facilities at intersections requires specific consideration for addressing conflict points between bicycle traffic and vehicle traffic. The main conflict points between people cycling and people driving at a typical intersection of two streets are:

- ✦ Through bicycle traffic with right turning motor vehicle traffic;
- ✦ Through bicycle traffic with left turning motor vehicle traffic; and
- ✦ Left turning bicycle traffic with through motor vehicle traffic.

Where conflicts with motor vehicles are more significant due to high traffic volumes, high speed vehicle turns, or at locations with limited sight distance, steps should be taken to reduce or eliminate

conflicts with other strategies such as restricting turn movements, providing traffic signal phasing that allows for fully protected cycling movements, providing physically separated operating space for people cycling (i.e., protected intersection), or providing grade separation.

Painted bike lanes are generally suitable only on lower speed and lower motor vehicle volume streets, where conventional intersection designs such as pavement markings, bike boxes, and two-stage turn queue boxes may be adequate. Larger or more complex intersections typically coincide with protected bike lanes or shared-use paths due to the motor vehicle traffic volumes and speeds. These locations require a greater degree of physical protection for people cycling and can include separate signal phasing of multimodal movements, two-stage turn queue boxes, and protected intersections.

The guidance on how to design for these conflict points should be matched with the bicycle facility type determined based on Section 3.2.3. The following sections provide a summary of common treatments, but the treatments shown are not exhaustive. Variations of the treatments may be required to address site specific context that considers space constraints, intersection of different facility types, etc.

Additional reference information to support design decisions are available in TAC GDG Section 5.6, the NACTO Urban Bikeway Design Guide, and the CROW Manual.

## INTERSECTIONS (CONT.)

### 3.6

#### 3.6.5.1 Protected Bike Lanes at Intersections

Intersections and driveway crossings with protected bike lanes must be carefully designed to promote safety and facilitate turns from the protected bike lane. In addition to TAC GDG, FHWA also provides useful information specifically on protected bike lanes at intersections.<sup>4</sup> Bidirectional protected bike lanes and contraflow bike lanes require additional considerations at intersections and driveways because they create unusual or unexpected conflict points. The approaches outlined in Section 3.6.6 can also be applied for bidirectional protected bike lane intersection Treatments.

The following provides information on designing common intersection treatments for protected bike lanes. For other intersection treatments refer to TAC GDG, TAC Bikeway Traffic Control Guidelines for Canada, CROW Manual, and FHWA Separated Bike Lane Planning and Design Guide.

##### Protected Bicycle Signal Phase

A protected bike lane with bicycle signal phase (Figure 3.55) allows people cycling to reach the intersection within a bike lane separated from motor vehicle traffic. The bicycle signal phase then provides temporal separation of bicycle and motor vehicle traffic rather than spatial separation. This eliminates conflicts with right turning motor vehicle traffic and the signal phasing can also be designed to mitigate conflicts between motor vehicle traffic and people walking and wheeling. Left turns for people cycling are typically carried out in a two-stage left turn to eliminate conflicts with through motor vehicles. Another option is to use an all-bicycle signal phase (similar to an all-pedestrian phase referred to as a “pedestrian scramble”) to remove conflicts between people cycling and those driving vehicles.



(All Red Phase)



(Vehicle Phase with Protected Right Turn)



(Bike Phase, Prohibited Vehicle Right Turn)

Figure 3.59: Protected Bicycle Signal Phase (No Lateral Shift)  
(Source: City of Vancouver)

<sup>4</sup> Federal Highway Administration (FHWA). 2015. Separated Bike Lane Planning and Design Guide. Report FHWA-HEP-15-025. McLean, Virginia: Federal Highway Administration.

## INTERSECTIONS *(CONT.)*

### 3.6

Where there is a parking lane forming part of the delineator of the protected bike lane as it approaches the intersection, the lane may “bend-in” toward the centre line of the street to be immediately adjacent to the travel lanes as illustrated in Figure 3.56. This improves visibility between people cycling and driving. It may also accommodate a curb extension which can benefit people walking and wheeling by decreasing crossing distance and providing amenity space.

A protected bike lane can “bendout” away from the centre line of the street, to create a spatially separated protected intersection or transition to an off-street facility which can be treated as a bike path at the intersection. Research indicates a bending out of the protected bike lane between 2 m and 5 m can have safety performance benefits and is preferred to the bend-in option.<sup>5</sup> The bicycle crossings can also be supplemented by being raised, similar to a raised crosswalk, to provide further safety benefits.<sup>6</sup> The bend-out option also provides queuing space for cyclists turning left from the bike facility.

For both bend out and bend in configurations, see Section 3.2.6.3 for minimum radius criteria for bicycle facilities.



**Figure 3.60:** Protected Bicycle Signal Phase with Bend-In

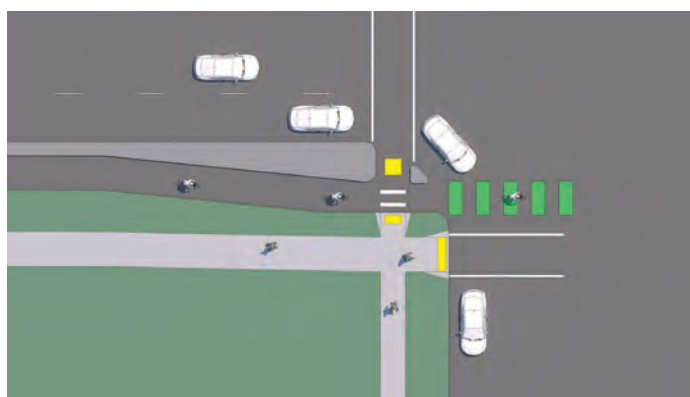

**Figure 3.61:** Protected Bicycle Signal Phase with Bend-Out

<sup>5</sup> de Groot, R. editor (CROW). 2016. Design Manual for Bicycle Traffic . The Netherlands: CROW.

<sup>6</sup> Martinson, R & Golly, T. 2017. Protected Bikeways Practitioners Guide . Washington, DC: Institute of Transportation Engineers

## INTERSECTIONS (CONT.)

### 3.6

#### 3.6 Two-Stage Left Turns

For a person cycling to make a normal left turn on multilane streets, a maneuver is required across one or more lanes of through traffic. In situations where traffic speeds may reach or exceed 50 km/h, or where there are few gaps in traffic, such a maneuver can be difficult to execute. In such situations, two-stage turn queue boxes are the preferred design approach associated with protected bike lanes and should be provided to offer the Design User group (i.e., “Interested but Concerned”) a safe way to make left turns by crossing the intersection in two stages. Two-stage turn queue boxes can be used in conjunction with one-way and two-way bikeways (i.e., bidirectional protected bike lanes, shared pathways, bike paths).

A two-stage turn queue box is a marked space for people cycling to wait outside of the Travelled Way portion of the street parallel to the bike lane. The preferred minimum dimensions of a two-stage turn queue box are 2.0 m by 2.0 m although sizes should be based on anticipated bicycle traffic volumes and site conditions. Common configurations place the two-stage turn queue box in line with the adjacent on street parking lane or between the bike lane and the crosswalk as illustrated in Figure 3.58.

While two-stage turns may increase comfort for people cycling in many locations, this configuration will typically result in higher average signal delay for people cycling due to the need to receive two separate

green signal indications before proceeding (one for the through street, followed by one for the cross street). Right turn on red restriction is also necessary for the cross street motor vehicle traffic to provide a conflict-free space for a person on a bicycle to enter and wait in the queue box during the red signal period.

#### Protected Intersection

Protected intersections provide a high level of comfort and safety for people cycling, especially at large intersections with multiple lanes and complex signal phasing. As illustrated in Figure 3.59, they provide dedicated space for people cycling that extends into the intersection and, as such, can accommodate through, left turn, and right turn bicycle movements in a safe and low stress manner, consistent with the Design User group requirements.

The conflict area between right turning vehicle traffic and through bicycle traffic at the intersection approach is eliminated, while the conflict area at the intersection is mitigated by introducing a corner safety island. The corner safety island orients a turning motor vehicle so that eye contact can be established between the person driving and people cycling.

A protected intersection accommodates bicycle left turn movements in two stages. However, relative to a two-stage turn queue box, a protected intersection provides greater physical protection for people cycling that are waiting for the second movement, even at



Figure 3.62 Two-Stage Left Turn Queue Boxes

## INTERSECTIONS (CONT.)

### 3.6

large intersections. A protected intersection also functions more intuitively because it replicates walking movements around the perimeter of the intersection. It is particularly beneficial where two streets with protected bike lanes intersect or where a wide buffer or parking lane separates a protected bike lane.

Within the protected intersection, the recommended setback for the protected bike lane crossing from the parallel travel lanes is 6.0 m. This provides adequate space for a single motor vehicle to queue outside the path of both through vehicle traffic and bicycle traffic. The presence of corner safety islands and crossrides (designated bicycle crossings, see Section 3.6.9.1) means that the person cycling is visible to the person driving.

The corner safety island at the far side of the intersection functions as a two-stage turn queue box regardless of the specific setback dimension. The corner radius of the safety island should be as small as feasible to accommodate the Design Vehicle while

encouraging slow motor vehicle traffic turning speeds and appropriate yielding behaviour. To accommodate Control Vehicles, the corner safety island can include a mountable apron to allow access and provide smaller corner radii.

Protected intersections can also be paired with separate bicycle signal phases and bicycle actuation. The bicycle crossings can also be raised, in conjunction with raised crosswalks, to further alert drivers to the crossing, increase yielding compliance, and manage traffic speeds across the crossride/crosswalk.

The protected bike lane delineator buffers for a protected intersection should be designed based on Universal Design. Curb cuts are recommended through islands where possible to minimize the impact on people crossing. Curb cut treatments through the median can include provisions of TWSI. Multiple TWSIs would need to be used through the medians to identify to people that they have not fully crossed the street.



Figure 3.63 Protected Intersection (Source: City of Vancouver)

## INTERSECTIONS (CONT.)

### 3.6

#### 3.6.5.2 Painted Bike Lanes at Intersections

##### *Bike Lanes with Right Turning Motor Vehicle Traffic without Right Turn Lane*

The continuous painted bike lane without a right turn lane allows people cycling to continue through the intersection within a bike lane and is typically marked prior and/or through the intersection with a dashed line pavement marking. Right turning vehicle traffic can signal and move to the curb, making the right turn movement from within the painted bike lane. When combined with a protected bicycle signal phase, temporal separation of people cycling and driving is provided eliminating conflicts with right turning motor vehicle traffic. The signal phasing can also be designed to mitigate conflicts between people walking/wheeling and driving. This is particularly applicable if walking and wheeling volumes are high. Without a protected bicycle signal phase, pavement markings through the intersection indicate where conflicts will exist and will need to be negotiated between bicycle traffic and motor vehicle traffic. The disadvantage of this design is that motor vehicle traffic conflict points with people cycling and people walking and wheeling in close succession. This places a more intense workload for people driving. Additional guidance on pavement markings to clarify right of way can be found in Section 3.6.9.

##### *Bike Lanes with Right Turning Motor Vehicle Traffic with Right Turn Lane*

If a right turn lane is provided at an intersection approach with a painted bike lane, it should be introduced to the right of the painted bike lane. A painted bike lane placed between two traffic lanes, such as a right turn lane in this case, should be at least 1.8 m wide, as per Table 3.8 in Section 3.2.3.2. With the right turn lane to the right of the painted bike lane, people cycling and driving negotiate the potential conflict upstream of the intersection. The design requires people driving to yield to people cycling before weaving across the painted bike lane.

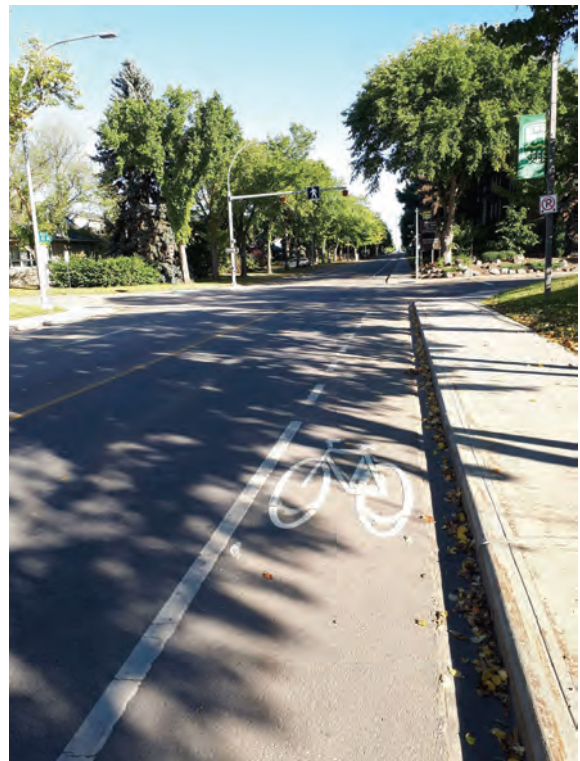

**Figure 3.64:** *Bike Lane Intersection Treatments without Right Turn Lane*

## INTERSECTIONS (CONT.)

### 3.6



**Figure 3.65:** *Bike Lane Intersection Treatment with Right Turn Lane*

The weave maneuver area (i.e., where drivers cross the painted bike lane) should be delineated with dashed lines as illustrated in Figure 3.61 to allow crossing of the white lane line. To further identify where the potential for conflict exists, the dashed lines may be supplemented with a coloured pavement surface treatment (see Section 3.6.9) conflict markings and additional signage.

The length of the weave maneuver area should be at least 15 m for a Design Speed of 50 km/h or less with up to 2,500 vehicles/day. On streets with more traffic (e.g., up to 4,000 veh/day), a length of up to 30 m should be considered to provide greater time and flexibility for people driving to complete the weave maneuver. Mixing Zones and Transitioning to Bike Paths or Protected Bike Lanes

Some designs for painted bike lanes at intersections render the bike lane discontinuous, either by “dropping” the bike lane completely or for a short section, or by implementing a “mixing zone.” Both treatments are essentially a shared lane configuration, which is only suitable for low motor vehicle traffic volumes and low speeds (see Section 3.2.3.1).

If the intersection context (e.g., available space, traffic volumes, traffic speeds) does not make it possible to provide an intersection bike lane design that is suitable for the Design User group (i.e., motor vehicle speeds over 50 km/h or volumes over 4,000 veh/day), an alternative may be to terminate the painted bike lane prior to the intersection and transition via a bike ramp to an off-street bike path or protected bike lane. The bike path or protected bike lane should be separate from the sidewalk to avoid wrong-way bike movements from the public realm onto the painted bike lane.

#### *Bike Ramps*

Bike ramps typically connect between on-street and off-street bikeways such as painted bike lanes connecting to shared pathways or bike paths. They may also be provided to enable bypass movements around a roundabout or complex intersection, as shown in **Figure 3.62**.

Bikeway ramps should generally be constructed at an angle of no greater than 30°, with a maximum slope of 6%.



**Figure 3.66:** *Bike Ramp from On-Street Bike Lane to Off-Street Bike Path or shared pathway*



## INTERSECTIONS (CONT.)

### 3.6 *Left Turns from Bike Lanes*

Similar to protected bike lanes, left turns from painted bike lanes can be accommodated using a two-stage left turn queue box, or a protected intersection. For more information on two-stage left turn queue boxes and protected intersections, see Section 3.6.6.1. Bike boxes, as well as dashed bike lane markings to allow traffic mixing, are also options.

**Use of a two-stage left-turn queue box or protected Intersection** is more likely to be suitable for the Design User group where traffic volumes are higher.

**Bike boxes** place cyclists in front of traffic stopped at a signal, and is illustrated in **Figure 3.63**. A bike box is a designated area at the head of a left turn or shared through/left turn lane at a signalized intersection that provides people cycling with a defined and visible space to use while waiting for a green signal indication. Bike boxes are paired with painted bike lanes and can assist people cycling in making a left turn if they arrive at the intersection during a red phase, as people driving must queue behind the stop line upstream of the bike box (i.e., advanced stop bar).

Bike boxes should be placed only at signalized intersections and right turns on red must be prohibited for motor vehicle traffic. Bicycle signal detection, typically loop or video detectors, can be installed within the bike box to detect the presence of people cycling and trigger the traffic signal. The requirement for a bicycle detection loop should be part of the signal assessment. Once the signal turns green, bike boxes no longer function as a bikeway element. Thus, as per Section 3.2.3.1, they are only suitable for the Design User group in contexts with lower traffic volumes and speeds associated with painted bike lanes.

#### 3.6.6 Bike Path & shared pathway Crossings

This section provides guidance on the treatment of bike paths and shared pathways at intersections

and mid-block crossings. Generally, the design treatments for these two types of bikeways are similar at intersections, since bike paths are frequently paired with a sidewalk. When marked with pavement markings and signs, street crossings for bike paths and shared pathways are called crossrides.

#### 3.6.6.1 Intersection Crossings

At street intersections, additional accommodation is required to inform people driving that the crossing is not only for people walking and wheeling, but for multiple types of off-street path users. These treatments may include, but are not limited to:

- ✦ Including a crossride along with the crosswalk at the path crossing to accommodate a larger variety of users;
- ✦ Incorporating design treatments such as a material change to the street surface;
- ✦ Using vertical deflection, such as a raised crossing to increase awareness of the crossing for people driving; and



**Figure 3.67:** Bike Box

## INTERSECTIONS (CONT.)

### 3.6

Adding a protected signal phase to the intersection crossing, either an advance bike/walk phase or a restricted right/left turn phase, that would eliminate many potential conflicts.

Details of crosswalk and crossside markings within the intersection are described in the MUTCD-C and TAC Bikeway Traffic Control Guidelines for Canada.

#### *Bend-Out and Bend-In Configurations*

Designing a bike path or shared pathway alignment to curve or bend prior to an intersection that parallels a street (bend-in or bend-out) can improve visibility of path users, moderates path user speeds, and alerts path users to the presence of an intersection. The bend-out configurations for a shared pathway is illustrated in **Figure 3.64**. For a bike path combined with a sidewalk, the design is similar, except that the cycling and walking and wheeling areas are separate, and at the intersection crossing, there is a crosswalk for the walking/wheeling path and a crossside on the side closer to the intersection for the bike path.

The bend-out option provides a setback from the parallel street which:

- + Provides additional reaction time to drivers turning across the path;
- + Allows drivers to orient their vehicles perpendicular to the path before crossing it, facilitating two-way sightlines between drivers and path users;
- + Enables a turning driver to avoid blocking through motor vehicle traffic while waiting for path users to clear; and

- + Provides space for people walking and wheeling queuing between the path and the curb ramp.

The bend-in option brings shared path users closer to the street edge, which:

- + Improve sightlines for people driving to see people using the path;
- + Allows for intuitive sharing of existing traffic signals at signalized intersections; and
- + Tends to require less space.

Bending the path out is generally preferred. The bend-out option provides generous queuing space in comparison with the bend-in option which provides little to no queuing space for people walking and wheeling perpendicularly across the path. For intersections with high volumes of crossing walking/wheeling traffic, the bend-out option is preferred.

In conditions where the shared pathways extend across an intersecting sidewalk, additional markings can be placed on the pathway to indicate to all users that they are entering a shared-use space. Additional signage can also be used for pathway users to require them to yield to the intersecting sidewalk users.



**Figure 3.68:** *Intersection shared pathways Crossing (Bend-Out)*

## INTERSECTIONS (CONT.)

### 3.6

#### 3.6.6.2 Mid-Block Crossings

At the approach to mid-block crossings, the shared-use path should be designed with speed-reducing elements such as alignment curvature or an uphill grade change in advance of the crossing. Other measures that may be applied include signage, textural surface contrast and pavement markings, such as zebra crossings for people walking and wheeling and crossrides for people cycling, and flashers or hybrid beacons in order to alert all users of the crossing and to advise which street user has the legal right of way. A typical treatment is shown in **Figure 3.65**.

Adequate sight distances for both shared pathway users and people driving are required to provide adequate reaction time for all users at the crossing and on the approach. Details on determining sight distances are provided in Section 3.2.

Mid-block crossings, their approach and the crossing, also require lighting of the crossing and to ensure people walking, wheeling, and cycling can be seen by people driving.



**Figure 3.69:** Mid-Block shared pathway Crossing

#### 3.6.7 Roundabouts

##### 3.6.7.1 Basic Roundabout Features

A **roundabout** is a type of circular intersection in which vehicles travel counter-clockwise where vehicles entering the roundabout must yield to circulating traffic. Roundabouts have specific geometric design and traffic control features, including:

- ✦ **Central Island** – The raised area in the centre of the roundabout, which the Circulatory Roadway travels around;
- ✦ **Splitter Island** – Raised or painted areas provided between the entry and exit lanes of an intersection leg to separate traffic, deflect and slow entering traffic, and allow for a two stage crossing for people walking and wheeling;
- ✦ **Circulatory Roadway** – The curved Travelled Way used by vehicles to travel in a counter-clockwise manner around the Central Island;
- ✦ **Walking & Cycling Facilities** – Sidewalks, shared pathways, local street bikeways, bike lanes, bike paths, and protected bike lanes that are used by people walking, wheeling, and cycling to travel around the roundabout. For low volume streets with mini-roundabouts, shared lanes may be suitable. For Roundabouts on higher volume streets should have bicycle facilities located outside the Circulatory Roadway;
- ✦ **Truck Apron** – A truck apron is a traversable, hard surfaced portion of the Central Island adjacent to the Circulatory Roadway with a mountable curb to accommodate the wheel tracking of large vehicles. Aprons can also be provided on the outside of the

## INTERSECTIONS (CONT.)

### 3.6

Circulatory Roadway at entrances and exits to manage entry and exit speeds for most vehicles and accommodate the swept path of trucks (e.g., WB-21, WB-36);

- + **Entrance Line** – A dashed line that marks the point of entry into the Circulatory Roadway. In some instances, the Entrance Line functions as the yield line, if no separate line is present;
- + **Walking & Cycling Crossings** – Crossings for people walking, wheeling and/or cycling are located upstream of the roundabout Entrance Line and downstream of the exit. The Splitter Island is cut at the crossing, approximately one car length from the Entrance Line, to allow people walking, wheeling, and/or cycling of all abilities to pass through;
- + **Landscape Buffer** – Landscape Buffers separate vehicular, walking and wheeling, and cycling traffic and assist with guiding people walking, wheeling, and cycling to the designated crossing locations. The Landscape Buffer, which forms part of the Furnishing Zone, can also help to enhance the aesthetics and appearance of the roundabout; and
- + **Inscribed Circle Diameter (ICD)** – While not a geometric design or traffic control feature, the ICD is a critical design dimension that influences the operational and safety performance of a roundabout. The ICD is defined as the diameter of the largest circle that can be fit into the roundabout outline.

**Figure 3.66** illustrates the geometric design features of a roundabout.

There are three main safety benefits of roundabouts as follows:

- + **Conflict Points** – The number of conflict points in a roundabout is greatly reduced as motor vehicle travel is in the same direction, eliminating right-angle and left-turn conflicts;
- + **Entering and Circulating Speed** – The design of a roundabout places high priority on speed control, which is achieved through geometric features. Drivers entering a roundabout are usually doing so at lower speeds which result in lower collision severity if drivers fail to yield and collide. This reduced speed also reduces the severity of collisions with people walking and wheeling. Speed differential between people cycling and driving is an important consideration of where to locate bicycle facilities; and
- + **Deflection Angle** – Roundabout entries provide deflections for motor vehicle traffic, decreasing the angle of impact during a collision and reducing entry speeds. This results in a significant reduction or elimination of typically more serious right-angle and head-on collisions.

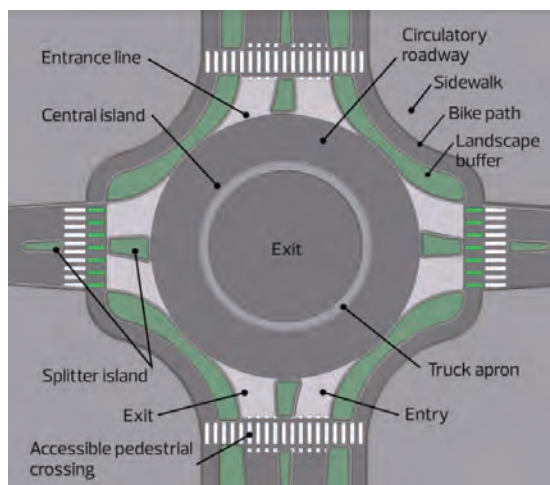

**Figure 3.70:** Basic Geometric Design Features of a Roundabout

## INTERSECTIONS (CONT.)

### 3.6

#### 3.6.7.2 Roundabout Design Principles

When considering roundabouts for an intersection treatment, the following factors should be considered:

- + Unbalanced traffic volumes on approach legs can lead to traffic congestion on minor approaches due to fewer gaps between motor vehicles on the Circulatory Roadway;
- + Higher construction cost for retrofit;
- + Larger right of way required;
- + Additional conflicts for people cycling and of the need to provide safe cycling facilities; and
- + Crossing locations for people walking, wheeling, and cycling are designed to avoid roundabout exit collisions, and thus are not the most direct routes and may pose issues for Universal Design, particularly for people with visual impairments.

In general, roundabout design should strive to achieve the same principles as other types of intersections. Specifically, for roundabouts, these principles include:

- + For motor vehicle traffic, provide low entry speeds and consistent speeds through the roundabout. This is achieved through the use of low entry and exit deflection angles;
- + Provide adequate entry width and circulating width with an appropriate number and assignment of lanes for the roundabout to provide the required traffic capacity;

- + Include proper intersection channelization, providing people driving with adequate guidance as to appropriate speed and path, and smooth transitions for entry and exit movements;
- + Include facilities and provisions adequate for all intended intersection users including people walking and wheeling, cycling, driving and delivering goods. Some roundabouts may not be suitable for people cycling on the street and a separated circulating path for people cycling will be required which may be unidirectional or bidirectional;
- + Ensure that roundabouts can accommodate movements for the appropriate design vehicle, Swept path analysis may be required to confirm maneuvers during design.
- + Ensure that adequate stopping and intersection sight distance and inter-visibility between users is provided for all intended users;
- + Include landscaping where possible and where sight distance is maintained. See Chapter 9 of the TAC Canadian Roundabout Design Guide for more direction on landscaping;
- + Include adequate lighting of the roundabout, crossings, and public realm. See Chapter 8 of the TAC Canadian Roundabout Design Guide for more direction on illumination; and
- + Design the landscape and roundabout elements to support winter operations. See Chapter 10 of the TAC Canadian Roundabout Design Guide for direction on winter control maintenance.

## INTERSECTIONS (CONT.)

### 3.6

#### 3.6.7.3 Types of Roundabouts

Three types of roundabouts are most commonly used in North America: mini-roundabouts, single-lane roundabouts, and multi-lane roundabouts. These roundabout types are described below and illustrated in **Figures 3.67, 3.68, and 3.69**. More information on roundabouts can be found in the TAC Canadian Roundabout Design Guide.

##### Mini-Roundabouts

Mini-roundabouts are small and characterized by a raised, but traversable central island and striped or mountable splitter islands to allow trucks to maneuver through the intersection without travelling around the island. Distinct from neighbourhood traffic circles because of the splitter islands, mini-roundabouts are commonly used in low speed urban environments and locations where right of way constraints cannot accommodate a typical single-lane roundabout.

##### Single-Lane Roundabouts

Single-lane roundabouts are characterized by deflection on the entry approach, single-lane entries, and one circulatory lane. When compared to a mini-roundabout, the central island diameter is much larger and the overall size is dependent on the Design Vehicle chosen. The geometric design often includes a central island, mountable truck apron (if required to accommodate the wheel tracking of large vehicles), raised splitter islands, and crosswalks/crossrides.

##### Multi-Lane Roundabouts

Multi-lane roundabouts are characterized by at least one entry with two or more lanes. The circulatory roadway is wider to accommodate vehicles operating side-by-side and may have higher entry, circulating, and exit speeds. The geometric design typically includes a central island with mountable truck apron (if required),

raised splitter islands, and crosswalks/crossrides. The circulatory roadway and exits are striped to accommodate each turning movement of the exit lane configuration in such a way as to require no lane changes for any movement through the roundabout.

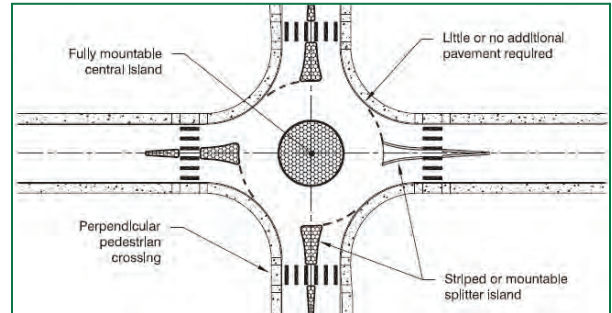

**Figure 3.71:** Features of a Typical Mini-Roundabout  
(Source: TAC Canadian Roundabout Design Guide Figure 9.21.1)

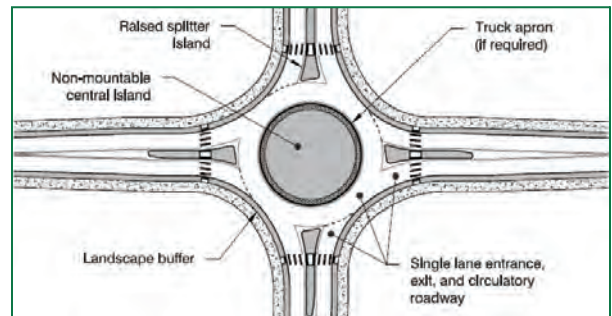

**Figure 3.72:** Features of a Typical Single-Lane Roundabout  
(Source: TAC Canadian Roundabout Design Guide Figure 9.21.2)

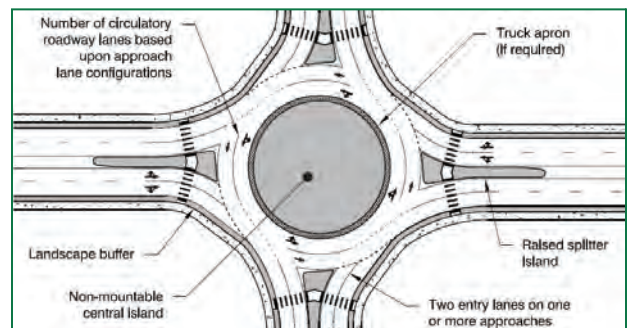

**Figure 3.73:** Features of a Typical Multi-Lane Roundabout  
(Source: TAC Canadian Roundabout Design Guide Figure 9.21.3)

## INTERSECTIONS (CONT.)

### 3.6

Key distinguishing features between each of these three roundabout treatments are summarized in **Table 3.29**. Daily service volumes noted represent the total daily motor vehicle traffic volumes travelling through the roundabout.

#### Other Circular Intersection Treatments

Two circular intersection treatments that are related to roundabouts, but have distinct features that place them in a different family of intersection treatments are Neighbourhood Traffic Circles and Turbo Roundabouts. Descriptions of these two circular intersection treatments are provided below.

#### Neighbourhood Traffic Circles

Neighbourhood traffic circles are typically constructed in residential areas for traffic calming and/or aesthetic reasons. In many locations, a neighbourhood traffic circle can be installed within the footprint of the existing intersection without impacting the curb lines. The intersection typically does not include raised channelization to guide the approaching driver into the circulatory roadway.



**Figure 3.74:** Neighbourhood Traffic Circle

Neighbourhood traffic circles do not necessarily enhance intersection control or capacity, but aid in slowing approaching vehicles to improve multimodal safety. For people cycling, it can allow them to conserve their momentum and reduce delays. Large vehicles may need to turn left in front of the circle due to limited turn radius, but these movements are typically very infrequent.

**Table 3.31** Roundabout Category Comparison

Design Element	Mini-Roundabout	Single-Lane Roundabout	Multilane Roundabout
<b>Desirable maximum entry design speed</b>	25 to 30 km/h	30 to 40 km/h	40 to 50 km/h
<b>Maximum number of entering lanes per approach</b>	1	1	2+
<b>Typical inscribed circle diameter</b>	13 to 27 m	27 to 55 m	46 to 91 m
<b>Central island treatment</b>	Fully traversable	Raised (may have a traversable apron)	Raised (may have a traversable apron)
<b>Typical daily service volumes on 4-leg roundabout below which may be expected to operate without requiring a detailed capacity analysis (veh/day)*</b>	Up to approximately 15,000 vpd	Up to approximately 25,000 vpd	Up to approximately 45,000 vpd for two-lane roundabout

\*Operational analysis needed to verify upper limit for specific applications or for roundabouts with more than two lanes or four legs. (Table Source: NCHRP RPT 672)

## INTERSECTIONS *(CONT.)*

### 3.6

#### *Turbo Roundabouts*

Similar to the multi-lane roundabout, the turbo roundabout is characterized by distinctive lane use requirements on entry and throughout the circulating and exiting paths to minimize lane changes through the roundabout. The turbo roundabout carries this concept further by using clear geometric paths for each movement, perpendicular entries to promote low entry speeds, and lane change restrictions within the roundabout. In the version of this design used in the Netherlands, these lane change restrictions are achieved through the use of raised curbs between the lanes within the Circulatory Roadway.

#### **3.6.7.4 Roundabout Design Methodology and Guidelines**

Roundabout design methodology will vary on a case-by-case basis. Most often, the goal of roundabout design is to optimize intersection operations while maximizing safety for all users of the intersection. The design process must consider the unique aspects of the individual intersection and the design parameters. The schematic presented in Section 3.6.1.1 of this document outlines a typical intersection design process which must be tailored to meet the needs of the individual project and applies to roundabouts as well. For guidance on geometric design elements for roundabouts refer to Section 6 of the TAC Canadian

Roundabout Design Guide. The design parameter table presented in Table 6.4 of the TAC Canadian Roundabout Design Guide summarizes typical ranges of values for each of the various design aspects of a roundabout. In addition, a brief narrative is included to outline the implications of using values within the Design Domain, as well as higher or lower values outside of the Design Domain. Standard detail drawings for a single-lane and mini-roundabout are provided in Chapter 3.

#### **3.6.8 Turn Lanes**

##### **3.6.8.1 Right Turn Lanes**

Right turn lanes are typically used on arterial streets, streets with higher Design Speeds, and streets with high right turn traffic volumes. The presence of right turn lanes can reduce the severity of conflicts between people driving through intersections and people turning right by separating slower turning movements from the faster through traffic. Right turn lanes can assist people who drive larger vehicles in negotiating turns and provides vehicle storage at intersections. However, right turn lanes have a negative effect on people who walk and cycle by increasing crossing distances (and exposure) and increasing mixing areas between through bicycle traffic and right turning motor vehicle traffic. Right turn lanes can also lead to auxiliary lanes (i.e., merge lane or free-flow lane) on the intersecting street.



## INTERSECTIONS (CONT.)

### 3.6

**Figure 3.75** illustrates the typical layout for right turn designs. The form of traffic control should be selected to suit the design and minimize conflicts between right turning, left turning, and through vehicles, as well as people walking, wheeling, and cycling.

The length of a right turn bay is determined by the storage requirements and required deceleration lengths.

A right turn lane taper is used to introduce the right turn lane. It is measured from the edge of the through lane at the start of the taper to the beginning of a full width right turn lane bay at the end of the taper. Right turn lane taper designs are a function of Design Speed, the width of the right turn lane, and the horizontal curvature.

More information on right turn lanes can be found in TAC GDG Sections 9.14.3 and 9.14.4, while information on right turn lane design with bicycle facilities can be found in Section 3.6.6 of this document. More

information on corner radii is included in Section 3.6.2. Appendix D of this document includes design matrices for guidance on the type of right turn treatments to use for both retrofit and new constructions.

Standard detail drawings for right turn lane treatments are contained in Chapter 3.

#### Channelization

Channelization at an intersection can be used for one or more of the following functions:

- ✦ Provide protected storage areas for turning vehicles, which enable people driving to decelerate and make the maneuvers necessary for the turn outside of the path of the higher speed through vehicles;
- ✦ Provide a refuge area for people walking and wheeling between the various traffic streams;



**Table 3.75:** Typical Layout for Right Turn Designs

## INTERSECTIONS (CONT.)

### 3.6

- + Reduce large areas of unused pavement, created by large corner radii or by skewed or flared intersection designs;
- + Separate and reduce areas of potential conflict and decision to ensure the driver is required to make only one decision at a time;
- + Control the angle of merging traffic streams;
- + Segregate traffic movements into left turning, right turning, and through traffic streams;
- + Control the speed of motor vehicle traffic;
- + Physically prevent or discourage undesired, unsafe, or wrong-way movements at an intersection;
- + Restrict access to adjacent land uses;
- + Effectively locate and protect traffic control and safety devices, including traffic signs, signals, and street lighting; and
- + Reduce conflicts with right turning vehicles.

Channelization is not recommended for intersections with high walking volumes in the following areas because it creates more points of conflict and reduces the comfort, convenience, and safety for people walking and wheeling

- + Downtown area;
- + Main Streets;
- + On-street bike routes;
- + Street oriented contexts; and
- + Transit Oriented Development areas.

Channelization can be achieved using a combination of pavement markings and raised concrete islands/ medians. These are supplemented with traffic control devices (i.e., signs and signals), and appropriate geometric design of pavement tapers and transitions, corner radii, and approach and departure geometry.

When designing channelization, drainage must be considered. Standard curb and gutter should be used and must include a means of collecting island and street drainage. For minor street islands not at intersections and with low traffic volumes reverse gutter may be considered.

## INTERSECTIONS (CONT.)

### 3.6

For the urban environment where a simple or compound radius is not possible, the “High Entry Angle” right turn channelization, shown in **Figure 3.76**, should be used. “High Entry Angle”, also known as “Aussie Rights” and “Smart Channel” treatments, are designed to increase the street entry angle and decrease the turning speed to be more consistent with the yield condition for people driving. “High Entry Angle” also reduces the viewing angle for the right turn maneuver (especially important for older people with poor head and neck rotational mobility) and improves the visibility of people walking, wheeling, and cycling to people driving. This design for right turn channelization is friendlier to people walking/wheeling/cycling, supports improved traffic operations, and decreases the workload for people driving. Standard designs for channelized right turn treatments in the City of Edmonton are contained in Chapter 3.

#### 3.6.8.1.1 High Entry Angle

Based on intersection geometry, angles of approach, turning movements or other extenuating design factors, additional tracking for larger vehicles such as WB21 or WB36 may be required to be accommodated. In order to maintain as many of the benefits of described above, a concrete apron can be used to supplement the High Entry Angle design and a detail is provided for reference on drawing #3130. The City of Edmonton has been piloting coloured concrete aprons using egyptian red and a pinwheel brick pattern to delineate the raised apron. Other jurisdictions within Alberta have been using similar colors in between dark red and brown earth tones.

#### 3.6.8.2 Left Turn Bays

Left turn lanes at intersections should be considered when the left turning motor vehicle traffic volumes create a hazard and significantly reduce motor

vehicle capacity of the intersection. The left turn lane requirements for two lane and four lane divided streets and undivided streets are based on volume, operational, and collision warrants. There may also be other instances of where left turn bays are warranted. Left turn warrants should be confirmed based on traffic analysis.

Left turn lanes are composed of a taper and bay and may include a median to separate the bay from other travel lanes in the Travelled Way. The median width at the intersection can vary and may include a refuge area for two-stage crossings for people walking, wheeling, and cycling.

On divided streets, the left turn lane taper is used to introduce the left turn lane into the median. As with right turn lanes, the taper is measured from the edge of the through lane at the start of the taper to the beginning of a full width left turn lane bay at the end of the taper. This is different from the approach taper for streets without a centre median, which is used to shift the through lanes laterally to the right to provide width for a left turn lane. Left turn lane taper designs are a



**Figure 3.76:** Right Turn Channelization “High Entry Angle”

## INTERSECTIONS *(CONT.)*

### 3.6

function of Design Speed, the width of the left turn lane, and the street curvature.

The storage length for a left turn lane is provided by the left turn bay and is normally designed to accommodate left turning vehicles queues as determined by traffic analysis. Storage length is equal to the bay length plus half the taper length for arterial streets.

More information on the design of different types of left turn bays can be found in TAC GDG Section 9.17. Left turn lane design for bicycle facilities are discussed in Section 3.6.6 of this document. Information on median design for left turn lanes can be found in Section 3.2.5. Standard detail drawings for left turn lane treatments can be found in Chapter 3.

#### *Slotted Left Turn*

Slotted left turn bays include a divisional island between the left turn lane and the adjacent through lanes. Slotted left turns are typically provided at intersections along major arterial streets or expressways wherever the median is wider than 10.8 m, where required to accommodate sightlines due to horizontal curvature, or where dual left turning lanes are proposed to minimize left turn interlock. Typical designs for slotted left turns are shown on the standard detail drawings in Chapter 3.

The advantages of slotted left turns include:

- Turning paths are clearly defined within an expansive median opening;
- Increased safety resulting from improved visibility for left turning drivers and the fact that

simultaneous opposing left turns are offset from one another;

- When signalized, increased capacity of the left turn lane movement due to reduced distance and time involved in making the maneuver; and
- Improved safety as lane changes from left to through, and vice versa, are not possible in the immediate area of the intersection because of the divisional island.

However, slotted left turns also significantly increase the crossing distance for people walking and wheeling, resulting in larger, less friendly intersections. Providing median refuge areas for people walking and wheeling can reduce this impact.

#### **3.6.9 Pavement Markings, Signs & Signals at Intersections**

The latest pavement marking guidelines for the City of Edmonton can be found in the City's Design & Construction Standards Volume 8. This document should be referenced for all standard longitudinal markings (lane lines, pavement edge lines, guidelines, etc.), lateral markings (crosswalks, stop bars), merging/diverging markings, and pavement symbols.

For more information on pavement markings, signage, and signals, refer to the MUTCD-C.

The purpose of the following is to provide further guidance on pavement markings, signs, and signals at intersections that are not included in Volume 8 and are required for the bicycle, walking and wheeling facilities, and intersection treatments included in the CSDCS.

## INTERSECTIONS (CONT.)

### 3.6

#### 3.6.9.1 Pavement Markings

Markings on the pavement serve an important role in any traffic control system by delineating space and providing guidance for people who walk and wheel, cycle, take transit, and drive.

Pavement markings work well in favourable conditions. However, information provided by pavement markings to street users can be limited seasonally or in weather conditions that impact their visibility. To mitigate this, pavement markings can be used in conjunction with signage to improve messaging. Pavement markings can also be used to supplement the regulation or warnings of other traffic control devices such as traffic signals.

The following section provides guidance for pavement markings related to people walking, wheeling, and cycling.

##### *People Walking and Wheeling*

Pavement markings for people crossing streets from the sidewalk or a shared pathway can increase visibility and raise awareness of their presence to people driving. They also serve to guide people across the street using the safer travel path.



**Figure 3.77:** Typical Crosswalk Pavement Markings

#### Intersection Crossings

Crosswalks are marked with either two parallel solid white lines (i.e., standard crosswalk) or a series of wide white lines running perpendicular to the crosswalk (i.e., zebra crossing) extending across the Travelled Way from curb to curb.

The width of the crosswalk is typically determined based on the widths of the sidewalks and curb ramps, and the number of people walking and wheeling or projected to walk across the street. The minimum width of the crosswalk is 2.5 m, with a recommended width of 4.0 m. In central areas and pedestrian priority areas, crosswalks should be at least 5.0 m in width.

Crosswalks should be placed at least 0.6 m back from the projected edge of the curb face on the cross street. Where stop lines are applicable, they should be placed 1.0 m from the crosswalk unless a bike box, two-stage turn queue box, or other need requires an advanced stop bar.

**Figure 3.77** illustrates the typical crosswalk pavement markings. More information on crossings for people walking and wheeling is provided in Section 3.6.5.



## INTERSECTIONS (CONT.)

### 3.6

#### Decorative Crosswalks

Decorative/creative crosswalk pavement marking treatments can provide value in highlighting and reimagining street crossings as an important extension of the public realm and for placemaking. The following provides an example of decorative Crosswalks.

Permanent decorative crosswalks may be applied at standard crosswalk locations and are recommended in areas with high concentrations of people walking and wheeling such as school zones and Main Streets.

Where proposed, the pavement should be in good condition and should be well lit to ensure high visibility. A decorative crosswalk design must include the existing standard parallel white crosswalk pavement markings at the edges of the decorative markings to meet minimum crosswalk design standards and provide clearly defined directional guidance. Specific details pertaining to the design and application of decorative crosswalks can be accessed through the City's Decorative Crosswalk Guidelines and in consultation with the City.

#### Intersection with Bicycle Facilities

Where a sidewalk or shared pathway intersects with bikeway facilities, the design of the intersection should intuitively suggest people walking and wheeling have priority as they are slower and more vulnerable than people cycling. Depending on context, this may be accomplished using signage, a marked and/or raised crosswalk, coloured or textured paving, or other specialized pavement markings (e.g., yield lines). Other strategies to promote safety of people walking and wheeling at intersections with bicycle facilities include:

- ✦ Continuing the striping, pavement materials, and/or grade (i.e., raised crosswalk) of the walking and wheeling facility across the conflict zone; and
- ✦ Signing the pedestrian crossing as such using a "Yield to Pedestrians" RB-39 sign, as per Section A2.2.5 of the MUTCD-C.

Markings should provide clarity on right of way and direction of travel for people walking and wheeling and those cycling. This is particularly important for crossings of two-way bikeways.



**Figure 3.78** Example of Decorative Crosswalk

## INTERSECTIONS (CONT.)

### 3.6

#### People Cycling

Intersections can be challenging and uncomfortable to navigate by bicycle, and therefore require careful design. Appropriate use of pavement markings can aid in reducing conflict between people cycling and people driving by reducing ambiguity regarding right of way. The MUTCD-C and TAC Bikeway Traffic Control Guidelines for Canada define pavement marking and sign guidelines. These documents emphasize uniformity of design and application to avoid confusion and to ensure people who cycle are able to navigate the bicycle network with ease.

#### Intersection Crossings

Intersection crossing markings such as dashed lines, shared lane markings, coloured pavement markings, and crossrides indicate the intended path of people cycling through an intersection, across a driveway, or across another zone of potential conflict. They guide people cycling on a direct path through the intersection/driveway and provide a clear indication of the paths of bicycle traffic to drivers in the adjacent lane. Pavement markings should be supplemented with signs to provide right of way and conflict zone information in all weather conditions.



**Figure 3.79:** Crossride Treatment for use with shared pathway

**Crossride** bicycle markings (i.e., crossrides) are used to define a bicycle traffic crossing area adjacent to a crosswalk where a shared pathway or off-street bike path intersects a street. The crossride markings may be placed on each side of the crosswalk markings or on just one side of the crosswalk markings, depending on the location of the bike path in relation to sidewalks. Crossride markings are two parallel square dashed markings that are typically 0.4 m by 0.4 m in dimension with a 0.4 m gap between squares. Crossrides must include appropriate traffic control signage on both the travelled way and bicycle facility, and should be limited to major bike routes.

**Figure 3.79** shows the use of the crossrides at a shared pathway crossing.

**Dashed guide lines** are two parallel white dashed lines of 200 mm in width, 1.5 m in length, and having a gap of 1.5 m between dashes that are used for painted bike lanes and protected bike lanes. The white dashes can be supplemented with green pavement marking between them. The use of dashed guide lines with green pavement markings is preferred at bicycle crossings associated with painted bike lanes and protected bike lanes. At crossings at roundabouts, crossrides are preferred.



## INTERSECTIONS (CONT.)

### 3.6

Where the path of motor vehicle traffic potentially conflicts with through bicycle traffic, it is recommended to use **green coloured pavement or green coloured pavement markings** within the intersection crossing markings. The colour may be applied using horizontal green bars or by colouring the pavement of the entire conflict area based on direction from the MUTCD-C. Specific guidance regarding conflict zone markings

may be found in TAC Bikeway Traffic Control Guidelines for Canada.

Solid green pavement markings should be used to delineate bike-only areas (such as bike boxes), while dashed green markings should be used to identify crossing or conflict areas (such as accesses). The green markings can be supplemented with white dashed lines.



**Figure 3.80** Green Coloured Conflict Marking Pavement Treatment



## INTERSECTIONS (CONT.)

### 3.6

#### Turn Boxes

In addition to pavement markings for crossings, pavement markings and supplementary signs can be provided to support turn movements by people cycling including bike boxes and two-stage turn queue boxes. These devices should include a white bicycle symbol, green coloured pavement within the boxes, stop lines for motor vehicle traffic (at bike box locations and possibly two-stage turn queue boxes depending on placement), and turn arrow markings (for two-stage turn queue boxes).

#### Bicycle Detection Marking Symbol

Figure 3.82 shows the bicycle detection marking symbol that may be used on the pavement to clearly identify the most sensitive area of detection on a signal actuation loop where a bicycle can activate the signal.

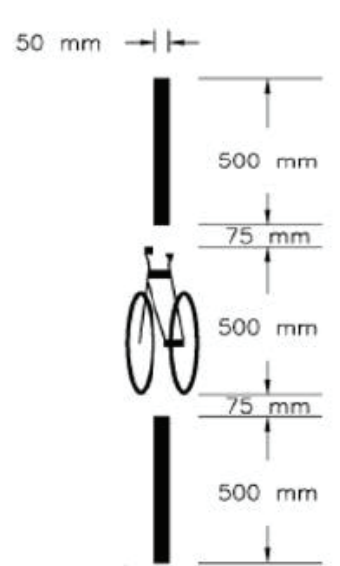

Figure 3.82 Bicycle Detection Marking Symbol (Source: TAC Bikeway Traffic Control Guidelines for Canada, Section 7.4.6, Figure 3.4)

#### Shared Roadway and Local Street Bikeway Markings

Shared lane markings (i.e., sharrows) are used to guide people cycling along roadways where people cycling share space with motor vehicles..



Figure 3.81 Two-Stage Turn Queue Boxes



Figure 3.83 Sharrow Pavement Marking

# INTERSECTIONS (CONT.)

## 3.6

### 3.6.9.2 Signs

Signs are an important traffic control device to supplement pavement markings, particularly in winter conditions. The MUTCD-C include regulatory signs that can be used at intersections as well as mid-block and their recommended sizes. Important regulatory signs to manage conflicts between motor vehicle traffic, people walking and wheeling, and people cycling include the following:



+ Right Turning Vehicles Yield to Bikes (RB-37)



+ Pedestrian and Bicycle Crossing Sign (WC-46)



+ Right Turning Vehicles Yield to Bikes and Pedestrians (RB-38)



+ Bicycle Trail Crossing Sign (WC-44)



+ Bicycles Yield to Pedestrians (RB-39)



+ Shared Pathway Sign (RB-93)



+ No Right Turn on Red (RB-17, RB-17 with Bicycle Exception shown)

# INTERSECTIONS (CONT.)

## 3.6



- + Crosswalk (RA-3 or RA-4)



- + Reserved Bicycle Lane Sign (RB-91 or RB-91 alt.)

## INTERSECTIONS (CONT.)

### 3.6

#### 3.6.9.3 Signals

The function of a traffic control signal is to efficiently assign the right of way between conflicting streams of traffic at an intersection, with minimal delay and operating conditions as safe as reasonably possible.

#### Bicycle Signals

Bicycle-specific traffic signals can help people cycling to safely operate through intersections. Elements that may be considered in the design of bikeways and traffic signals include bicycle actuation, the use of bicycle signal faces, and leading or lagging bicycle intervals. Bicycle signals display a red, amber, or green indication that is in the shape of a bicycle.

Further information regarding bicycle traffic signals can be found in the MUTCD-C and TAC Traffic Signal Guidelines for Bicycles. [Figure 3.84](#) shows a bicycle traffic signal head.



**Figure 3.84** Bicycle Traffic Signal Head

#### Bicycle Signal Heads

Bicycle signal heads should be installed on the far side of intersections within 30 m of the stop bar for people cycling. For more complex intersections where the far side is greater than 30 m away, consideration may be given to use 300 mm bicycle signal lenses for far side signal heads and/or installation of 200 mm supplementary bicycle signal lenses on the near side of the intersection or median of the intersecting street.

#### Bicycle Signal Timing & Leading Bicycle Intervals

The design of the bicycle traffic signal timing will depend on the type of bicycle facility and how it will operate with the motor vehicle phasing. The bicycle signal timing phase can run with the main traffic signal phasing, as a protected (or exclusive) bicycle-only phase, or a combination. The integration of a protected bicycle signal phase may be used to eliminate conflicts between turning motor vehicle traffic and through bicycle traffic and can be used in conjunction with No Right Turn on Red signs. To minimize delay for all intersection users, bicycle signal phases should be incorporated into existing traffic signal operations, whenever possible.

Common European practice is to display a bicycle green phase a few seconds before the adjacent motor vehicle green phase (i.e., leading bicycle interval) and to terminate bicycle phase earlier than the adjacent vehicle to allow for turns across the bikeway. This also provides an earlier start for people cycling, allowing them to clear the intersection before conflicting right turning motor vehicle traffic proceeds. Leading bicycle intervals can be coordinated and operate at the same time as leading pedestrian intervals.

#### Bicycle Actuation

Induction loops can be installed to detect bicycles at actuated traffic signals. To ensure that bicycles are detected, quadruple or diagonal quadrupole loop detectors are recommended because they are bicycle sensitive over the entire area. Video detection is another alternative.

## INTERSECTIONS *(CONT.)*

### 3.6

#### *Walk Signals*

The following considerations and other aspects of walk signals are can be found in the TAC Pedestrian Crossing Control Guide.

#### *Pedestrian Signal Indicators & Countdown Timers*

Pedestrian signal indicators display whether people walking and wheeling have adequate time to begin crossing a street at a signalized crosswalk. All traffic signals should be equipped with pedestrian signal indicators, except where signage prohibits the crossing. In most cases, the pedestrian signal indication should be displayed automatically as part of the signal phasing and not require actuation except for in very low density, non-street oriented contexts such as Industrial Areas.

Pedestrian countdown timers are beneficial to people walking and wheeling, as they help people walking and wheeling to identify how much time remains to finish crossing the intersection before the signal phase ends. All new traffic signals in the City shall include pedestrian countdown timers. Location conditions and operational details are described in more detail in the MUTCD-C.

#### *Walk Times to Support Universal Design*

Providing adequate crossing time for people walking and wheeling is a critical element of the walking and wheeling environment at signalized intersections. The crossing time includes the observation-reaction time, the walking time, plus a safety margin.

The MUTCD-C and the TAC Canadian Capacity Guide for Signalized Intersections recommended signal timing requirements to accommodate people walking and wheeling based on their walking/wheeling speed and should be based on the walking speed of an older adult. In general, the length of a motor vehicle signal phase with parallel walking movements should provide sufficient time for a person walking to safely cross,

including both a sufficient “walk” interval and necessary clearance time. If this cannot be provided, a centre refuge area must be provided.

#### *Leading Pedestrian Intervals*

Leading pedestrian intervals provide people walking and wheeling with a head start sufficient to cross the first lane of traffic. A period of 3 to 7 seconds is given to enter the crosswalk, where they are more visible to people driving, and before conflicting motor vehicle traffic on the parallel approaches are permitted to enter the crosswalk.

Extended pedestrian clearance intervals and/or leading pedestrian intervals may be appropriate at crosswalks with high volumes of walking traffic and turning motor vehicle traffic, parked cars, or where the population demographics indicate a high proportion of people that walk slower (e.g., near seniors’ residences, schools, hospitals). Where walking and wheeling volumes are high, a separate pedestrian-only signal phase may be beneficial.

#### *Audible and Accessible Signals*

Audible and accessible signals aim to direct people walking and wheeling at intersection crossings that have visual impairments. The technique incorporates the use of specific sounds, actuation settings, volume control, and convenient location for the effective guidance of walking and wheeling movements.

Accessible pedestrian signals should be placed for easy access, especially when actuation is not automated and the user has to actuate the signal for its use. The location should be within 1.5 m of the edge of the crosswalk line and between 0.5 m and 1.8 m from the edge of curb. It should also be away from another audible signal device as the distance between two pushbuttons can substantially influence the configuration perceived by the user. Poles

## INTERSECTIONS (CONT.)

### 3.6

should be installed as separate as possible to avoid misguided orientation with a preferred offset 3m. Where the layout does not provide for an intuitive design and sound direction is not clear, features such as information messages can be used to identify the intersection and crossing street information. The visual signal head should also be placed in proximity to the pushbutton to be easily recognized as part of the intersecting crossing and, thus, recommended to be located on the right of the pushbutton.

#### 3.6.10 Intersection Spacing, Driveways, & Access Management

For design guidance on intersection spacing, driveways, and access management, refer to the City's Access Management Guidelines. The Access Management Guidelines are intended to assist in the planning of vehicular access for development or redevelopment of land parcels within Edmonton. Guidance is provided on the location, type, and configuration of accesses in context with a variety of factors such as safety, convenience, adjacent land use, traffic/transit operation, adjoining street classification, and street character.

#### 3.6.11 Emergency Access

Secondary emergency accesses shall be provided whenever the length of a cul-de-sac exceeds 120 m (as measured from the centre of the cul-de-sac to the centre of the intersection), or whenever the bottle neck length of any "lollipop" design exceeds 120 m (as measured from the centre of one intersection to the centre of the second intersection). The secondary emergency access may take the form of an emergency access connection via an off-street path. Alleys will not be considered for emergency access, except for reverse housing lanes.

The off-street path shall be centred on the right of way (straight alignment) and constructed to the satisfaction of the City. The off-street path width shall

be a minimum of 3.0 m to allow access by emergency vehicles, as shown on the standard detail drawings in Chapter 3, with additional widening as required to accommodate turning maneuvers.

Swept path analysis for a City of Edmonton fire apparatus shall be provided in support of all off-street paths to be designated for emergency access. A clear zone shall be provided for all emergency access off-street paths which is equivalent to the greater of:

- ✦ 4.0 metres; or
- ✦ The edge of the vehicle swept path envelope plus 0.30 metres per side.

The swept path analysis shall take into consideration on-street parking along the adjacent streets. Where the swept path cannot be accommodated without the need for parking restrictions, approval will be required. Parking restrictions in excess of 15 m will not be permitted.

Signage shall be installed at all emergency accesses and off-street path connections to restrict vehicular access to emergency and maintenance vehicles. At the discretion of the City, bollards may be required at each end of the off-street path access, as shown on the standard detail drawings in Chapter 3. The posts shall prevent non-emergency vehicle access while allowing access for maintenance equipment and emergency vehicles. Roll face curbs at the approaches to the off-street paths are adequate.

The normal gradient for emergency access off-street paths shall be 0.7% and the minimum gradient shall be 0.5%. The maximum gradient shall not exceed 8.0%.

Where off-street paths provide access to utility corridors and natural areas, fire hydrants shall be provided at the nearest property line or where the trail ties into the street network to accommodate firefighting access.

## OFFSETS AND UTILITY ALIGNMENT

### 3.7

Utilities can include sewer, water, gas, telecommunications, and power for street lights/traffic signals and auxiliary power for signs, transit shelters, and other street furniture elements. Within the public realm in urban areas, underground utilities may be located in all the design zones – Ancillary Zone, Furnishing Zone, Pedestrian Through Zone, and Frontage Zone.

Utilities are provided to service the buildings along urban streets, the infrastructure along these streets, and the adjacent communities. In many cases, utilities are located along existing urban streets, either underground or overhead. Deep utilities usually run under the street Travelled Way or Ancillary Zone and shallow utilities usually run under the Furnishing Zone or Pedestrian Through Zone, though they may also be located in the Frontage Zone or easement on private property within the Adjacent Lands.

The offset of utilities, street furniture, and landscaping from other elements in the street right of way is an important factor related to traffic safety, street user behaviour, and constructability. The offset between some elements (e.g., water mains and sanitary sewer) are Provincially legislated. The offsets presented in this section take into account these legislated offsets as well as the offsets outlined in the City's Design and Construction Standards Volumes 3, 4, 5, and 7 (Drainage, Water, Landscaping, and Power, respectively). The offsets to street lighting, poles, traffic-related cabinets, and trees are also informed by the TAC GDG Section 7.7.

Based on TAC guidance, the use of the Clear Zone design concept for higher speed streets is not applicable, practical, or desirable for arterial, collector, and local streets. This is due to the typical conditions along urban streets with lower target operating speeds, denser development, limited right of way, closely spaced intersections, and multimodal street users. In these urban environments, lateral clearance (i.e., horizontal offsets) is typically provided to improve operations rather than shielding obstacles.

The Design Domain for offsets between utilities, poles, cabinets, trees, sidewalk/path, and face of curb are provided in Table 3.30. Where noted, refer to the referenced Volume of the City's Design and Construction Standards for offsets. For more information on offsets to intersections and driveways as related to sightlines and clear sight triangles, refer to Section 3.6 of this document. Additional design requirements for offsets are included in Table 3.33 with reference to the relevant Volume of the City's Design and Construction Standards. Utility fixtures and appurtenances shall not be placed within the pedestrian through zone.

# OFFSETS AND UTILITY ALIGNMENT (CONT.)

## 3.7

Note: For any projects signed after July 2020, the Volume 1: Table of Offsets has precedence over any offsets also shown in Table 3.32. The volume 1 Table of Offsets is available at: City of Edmonton Design and Construction Standards

**Table 3.32** Design Domain: Offsets for Utilities, Poles, Cabinets, Trees, Sidewalk/shared pathway, and Face of Curb (in m)

Parameter: Offsets for Utilities, Poles, Cabinets, Trees, Sidewalk/shared pathway, and Face of Curb	Design Domain	
	Minimum	Target
<b>Offsets to Face of Curb</b>		
<b>Streetlight Pole (centre of pole) to Face of Curb</b>	0.5 m when adjacent to Ancillary Zone or Painted or Protected Bike Lane; 1.2 m to Travelled Way; To be in line with Trees or closer to Face of Curb	1.25 m along Local Streets; 1.25 m along Collectors; 2.0 m along Arterials; 2.6 m for monowalks along Local and Collector Streets 3.0 m for monowalks adjacent to School Sites
<b>Tree (centre of tree) to Face of Curb</b>	Trees to be placed in line with or further from Face of Curb than Streetlight Poles; See also the City's Design and Construction Standards Volume 5	
<b>Transformer (centre of transformer) to Face of Curb (Local Streets)</b>	2.0 m	
<b>Deep Utilities (centreline) to Face of Curb</b>	1.5 m	
<b>Offsets to Active Transportation</b>		
<b>Streetlight Pole (centre of pole) to Sidewalk/Shared-Use Path (edge of sidewalk or path)</b>	0.5 m	1.0 m
<b>Streetlight Pole (centre of pole) to Walkway (edge of walkway)</b>	0.5 m	1.5 m
<b>Hydrant (centre of hydrant) to Edge of Ancillary Zone active uses (e.g., patio, boardwalk, bike corral)</b>	1.5 m	
<b>Multi-party Trench (centreline) (e.g., main power, streetlight feeds, phone, telecoms) to Face of Curb</b>	2.5 m	
<b>Location of all surface appurtenances associated with underground utilities (including, but not limited to, transformers, cubicles, catch basins, manholes and utility covers, water valves, power/telecom vaults) with respect to Active Transportation Infrastructure</b>	Located outside of any sidewalks, shared pathways, walkways, crosswalks, and curb ramps; See also the City's Design and Construction Standards Volumes 3, 4, and 7	



## OFFSETS AND UTILITY ALIGNMENT (CONT.)

### 3.7

Note: For any projects signed after July 2020, the Volume 1: Table of Offsets has precedence over any offsets also shown in Table 3.33. The volume 1 Table of Offsets is available at: City of Edmonton Design and Construction Standards

**Table 3.33** Design Domain: Offsets for Utilities, Poles, Cabinets, Trees, Sidewalk/shared pathway, and Face of Curb (in m)

Parameter: Offsets for Utilities, Poles, Cabinets, Trees, Sidewalk/shared pathway, and Face of Curb	Design Domain	
	Minimum	Target
<b>Offsets to Intersections</b>		
<i>Catch Basin to Intersection</i>	Locate at End of Curve OR Beginning of Curve and not within the curb ramp and crosswalk; See also the City's Design and Construction Standards Volume 3	
<i>Poles (centre of pole) to Intersection</i>	0.9 m	
<i>Trees (centre of tree) to Intersection</i>	15 m	
<i>Transformer/Cubicle Cabinet (centre or transformer/cabinet) to Intersection (edge of pavement)</i>	15 m	
<i>Traffic Control Cabinet (centre of cabinet) to Intersection (edge of pavement)</i>	Locate outside the Clear Sight Triangles to allow for required sightlines	
<b>Offsets to Accesses &amp; Driveways</b>		
<i>Streetlight Pole (centre of pole) to Residential Driveway (edge of driveway)</i>	1.0 m	
<i>Streetlight Pole (centre of pole) to Commercial/Industrial Access (edge of access)</i>	1.5 m	
<i>Transformer/Cubicle/Traffic Control Cabinet (centre of cabinet) to Commercial/Industrial Access (edge of pavement)</i>	10 m	

## OFFSETS AND UTILITY ALIGNMENT (CONT.)

### 3.7

Note: For any projects signed after July 2020, the Volume 1: Table of Offsets has precedence over any offsets also shown in Table 3.34. The volume 1 Table of Offsets is available at: City of Edmonton Design and Construction Standards

**Table 3.34** References for Other Offsets for Utilities, Poles, Cabinets, Trees, Sidewalk/shared pathway, and Face of Curb

<i>Parameter: Offsets for Utilities, Poles, Cabinets, Trees, Sidewalk/shared pathway</i>	<i>D&amp;C Volume Source(s)</i>
<i>Transformer / Switching Cubicle to Bus Stop Pad</i>	Volume 7
<i>Pad-Mounted Equipment to Edge of Walkway Property Line</i>	Volume 7
<i>Pad-Mounted Equipment to Transportation Signs</i>	Volume 7
<i>Power Crossings to Bus Stop Pad</i>	Volume 7
<i>Transformers to Residential Driveways</i>	Volume 7
<i>Tree to Edge of Commercial or Industrial Accesses</i>	Volume 5
<i>Tree to Edge of Residential Driveways</i>	Volume 5
<i>Tree to Transit Zone</i>	Volume 5
<i>Tree to Streetlight Pole</i>	Volume 5
<i>Tree to Traffic Control Sign</i>	Volume 5
<i>Tree to Sidewalk/shared pathway</i>	Volume 5
<i>Hydrant to Face of Curb</i>	Volume 4

<i>Parameter: Offsets for Utilities, Poles, Cabinets, Trees, Sidewalk/shared pathway</i>	<i>D&amp;C Volume Source(s)</i>
<i>Hydrant to Transit Stop</i>	Volume 4
<i>Hydrant to Driveway</i>	Volume 4
<i>Manhole to Face of Curb</i>	Volume 3 & 4
<i>Manhole or Utility Cover to Sidewalk/Shared-Use Path</i>	Volume 3 & 4
<i>Catch Basin to Edge of Sidewalk or Path</i>	Volume 3
<i>Catch Basin to Intersection</i>	Volume 3
<i>For additional offsets related to Drainage Infrastructure</i>	Volume 3
<i>For additional offsets related to Water Infrastructure</i>	Volume 4
<i>For additional offsets related to Landscaping Infrastructure</i>	Volume 5
<i>For additional offsets related to Auxiliary and Secondary Power Infrastructure</i>	Volume 6
<i>For additional offsets related to Power Infrastructure</i>	Volume 7

Other utility requirements for street design include:

- + Auxiliary power should be provided along all street oriented commercial streets which requires coordination with Business Improvement Associations (BIAs). Power receptacles are to be attached to trees (at a minimum height of 2 m above ground level) and/or street lighting poles and should be readily accessible to support outdoor lighting, festivals, and other events. See Design and Construction Standards Volume 6 for street lighting requirements;
- + The City has developed a multi-party shallow utility trench arrangement and detailed standards which are to be used for all new construction. This allows for a number of shallow utility providers to locate their services within a common trench making efficient use of available right of way. The multi-party trenching Standard Details can be found in Chapter 3;
- + Installation of hydrants in rural areas will require the construction of an access pad. Hydrants are typically placed at 1.5 m off of the edge of asphalt, with a pad extending from 1.5 m behind the hydrant to the Travelled Way surface and 1.5 m either side. The pad sides are to be sloped to match the ditch grading and no steeper than 4:1 (adding culverts as required) and is to be sodded. The pad shall be surfaced with road crush or asphalt on the top. Protection posts are required on the hydrant pads; and
- + The lighting design and other utilities must be shown on the construction plan submitted for City approval.

## TRAFFIC CALMING

### 3.8

This section draws upon the 1998 TAC Canadian Guide to Neighbourhood Traffic Calming (CGNTC), which is currently being updated. This section also draws on selected considerations from the CIMA+ "Effective Engineering Measures That Address Speeding Issues on Residential Roadways in Edmonton" (2012) report prepared for the City.

Furthermore, the City has adopted a Community Traffic Management Policy (C590) to guide how the City will work with communities to address traffic concerns in their neighbourhoods. A framework for the implementation of the policy and guidance on the implementation of traffic calming measures in an Edmonton context, is currently under development.

The 1998 Canadian Guide to Neighbourhood Traffic Calming defines traffic calming as "...the combination of mainly physical measures that reduce the negative effects of motor vehicle use, alter driver behaviour and improve conditions for non-motorized street users."

Traffic calming involves altering motorist behavior on a single street or portion of a street network to achieve behaviour that is appropriate within the context of a street's intended use. It can also involve traffic management, or changing traffic routes or flows within a neighbourhood. Measures are usually applied to local and collector streets where there is demand for traffic calming and where it has proven to be effective.

#### 3.8.1 Objectives & Principles

The objective of traffic calming is to determine the best combination of measures that result in an improvement, both real and perceived, in the quality of life in a neighbourhood.

Traffic calming is intended to achieve one or more of the following objectives:

- + **Reduce vehicular speeds.** Speeding increases the risk to all street users, and especially people walking, wheeling, and cycling, creates more noise, and detracts from a neighbourhood's livability;
- + **Discourage through traffic.** High volume non-local traffic increase noise, congestion, and delays within a neighbourhood;
- + **Minimize conflicts between street users.** Though physical separation of street users is effective, reducing vehicular speeds and volumes, correcting geometric deficiencies and improving sightlines all can help to reduce conflicts; and,
- + **Improve the neighbourhood environment.** In addition to providing an opportunity for aesthetic enhancements through landscaping and design features, traffic calming installations have the potential to improve the feeling of safety and security for residents, improve the sense of community identify, reduce noise and air pollution, and increase the level of comfort for vulnerable users.

## TRAFFIC CALMING (CONT.)

### 3.8

There are a number of principles of traffic calming whose application will maximize the effectiveness of a traffic calming strategy. These include:

- + **Identify the real problem.** Perceived issues from residents may not be the real issue(s);
- + **Quantify the problem.** Collect data to determine degree and time of day of the problem;
- + **Consider improvements to the arterial street network first.** Motorists may short-cut because there is a congestion issue on a nearby arterial. Consideration must be given to managing congestion on the arterial streets, if it can be effectively addressed;
- + **Apply traffic calming measures on an area-wide basis.** Consider adjacent streets and the larger area. Otherwise traffic calming to solve issues on one street might deflect the problem to an adjacent street;
- + **Avoid restricting access and egress.** Restricting access is generally not received well by some community residents and may be detrimental to the provision of emergency services;
- + **Use self-enforcing measures.** Physical measures are more effective than signage alone, (for example, turn prohibition signs) which requires enforcement;
- + **Consider all services.** Consider transit, police, fire, ambulance, waste collection, and snow clearing to help minimize delays and impacts to these services; and,
- + **Monitor and follow-up.** Report back on the success of traffic calming measures to justify expenditure and enhance the credibility of the traffic calming efforts, and to evaluate and adapt practices based on lessons learned.

### 3.8.2 Types of Traffic Calming

Traffic calming measures can be grouped into 3 general categories: vertical deflection, horizontal deflection, obstruction, and signing.

**Vertical deflection** describes those physical measures that cross the street and affect the comfort of motorists travelling too fast. In Edmonton, these include raised crosswalks, raised intersections, sidewalk extensions, speed humps, speed cushions, and speed tables. **Figure 3.85** illustrates an example of vertical deflection - a raised crosswalk. See section 3.6.4.3 for more information.



**Figure 3.85** Raised Crosswalk

**Horizontal deflection** describes those physical measures that narrow the street and affect the comfort of motorists travelling too fast. In Edmonton, these include chicanes, curb radius reductions, on-street parking, raised median islands, and traffic circles. lateral shift, speed kidneys, lane narrowing, and road 'right-sizing'. **Figure 3.86** illustrates an example of horizontal deflection - a chicane.



**Figure 3.86** Chicane

## TRAFFIC CALMING (CONT.)

### 3.8

**Obstructions** are physical measures that affect access to/from a street that is being traffic calmed. In Edmonton, these include directional closures, diverters, full closures, intersectional channelization, raised median through the intersection and right-in/right-out islands. Figure 3.83 illustrates an example of an obstruction - a full closure.

**Signing** can include regulatory signs that regulate traffic movements (e.g. no left turn restriction), though these have limited effectiveness without enforcement. There are also signs that identify other traffic calming measures (at their location, and/or in advance).



Figure 3.87 Full Closure

#### 3.8.3 General Design Considerations

General design considerations that apply to the design of traffic calming measures include:

**Grades.** Minimum and maximum grade guidelines apply to many traffic calming measures. Vertical deflection measures, for example, should not be installed on a street exceeding 8% gradient due to potential adverse effects on vehicle control.

**Surface Drainage.** Drainage design to avoid ponding and ice build-up is critical. For example, catch basins should be located on the uphill side of traffic calming devices.

**Underground Utilities.** Traffic calming plans need to consider the need for access to underground utilities.

and the potential effect of roots on underground utilities from heavily landscaped measures.

**Construction Materials.** Materials used for traffic calming must be capable of withstanding heavy traffic loads, drainage, snow clearing operations, and freeze-thaw action. Thick paint or other materials that would make the Travelled Way surface slippery when wet should be avoided.

**Signs.** Traffic calming features typically require signs to advise street users of their location. In the interest of community aesthetics, efforts should be made to avoid installation of advance warning of these features.

**Streetscaping.** The introduction of landscaping and the presence of mature trees can enhance a traffic calming measure visually, and increase driver’s awareness and reduce their travel speeds. Care must be taken to ensure that landscaping does not obscure sightlines.

**Maintenance.** There are two major maintenance considerations – repairing damage to vertical deflection measures being struck by snow clearing equipment, and removal of the accumulation of leaves, debris, and snow. Measures should be clearly identified and equipment operators made aware of these types of measures. Additional consideration is necessary to ensure that landscaping is maintained to eliminate obstructions of sightlines.

**New Construction vs. Retrofit.** Streets in new areas should be built in a manner which minimizes the need for traffic calming measures due to shortcutting and speeding. Traffic calming measures may still be utilized to further improve safety for vulnerable users, particularly near schools and other community destinations. In retrofit situations, additional care must be taken to ensure that traffic calming measures do not have unintended adverse impacts on other routes through a community, and must balance the needs of all street users.

## TRAFFIC CALMING (CONT.)

### 3.8

**Education and Enforcement.** Education of street users can improve compliance and understanding of the measures deployed in a community. Enforcement can further improve compliance with traffic calming measures, however, consideration should be given to the installation of measures that decrease the need for enforcement, and are self-explanatory to street users.

For more details on these considerations, refer to Section 4.1 of the 1998 Canadian Guide to Neighborhood Traffic Calming.

#### User Considerations

General user considerations that apply to the application of traffic calming measures include:

**Emergency Services.** There is a need to balance between the benefit of decreased frequency and severity of collisions due to the installation of traffic calming devices with the disbenefit (e.g. increased response time) to emergency services. Emergency Services should be consulted during the development of a community traffic calming plan to effectively strike this balance.

**Transit Services.** The comfort of transit passengers, and the convenience of service must be considered. In some cases, horizontal deflections may be preferred over vertical deflections on transit routes, and turning movements of transit vehicles must be considered.

**Long Vehicles.** Knowledge of truck, bus, and emergency routes within a community is necessary when developing a traffic calming plan. Horizontal deflection measures such as curb radius reductions, traffic circles, and directional closures which are restrictive to large turning radius vehicles should only be located in neighbourhoods where truck and bus volumes are low and emergency access into an area can still be accommodated via other routes, if necessary.

**People Walking, Wheeling & Cycling.** Implementation of traffic calming measures should ensure access for people walking and wheeling, and should minimize impacts on active modes, with the following considerations:

- ✦ Medians and refuge islands are most valuable on major corridors that present safety problems for people cycling, walking, and wheeling who wish to cross;
- ✦ Avoid extending speed humps across the entire Travelled Way so that bicycles can travel beside the measure without having to travel up and over the hump; and
- ✦ Horizontal measures should be clearly marked to enable people cycling to identify and anticipate them.

For more details on user considerations, refer to Sections 3.1, 3.2 and 3.4 of the 2016 CIMA+ Traffic Calming Report. For more details on long vehicles, refer to the 1998 TAC CGNTC.

#### 3.8.4 Detailed Design Guidelines

Detailed geometric and design guidance (including design drawings), are provided in Chapter 4 of the TAC CGNTC. The specific section for detailed design guidance for each of the four traffic calming measure types is provided below:

- ✦ Vertical deflection measures: Section 4.2;
- ✦ Horizontal deflection measures: Section 4.3;
- ✦ Obstruction measures: Section 4.4; and
- ✦ Traffic calming signs: Section 4.5.

# TRAFFIC CALMING (CONT.)

## 3.8

### 3.8.5 Selection & Implementation

#### Benefits/Disbenefits

Using the four traffic calming measure types, **Table 3.35** provides a summary of the potential benefits of these and other common traffic calming measures in terms of speed reduction, volume reduction, conflict reduction, and environment.

**Table 3.35** Traffic Calming Measures – Potential Benefits (Adapted from 1998 TAC CGNTC Table 3.2)

Measure		Potential Benefits			
		Speed Reduction	Speed Reduction	Conflict Reduction	Environment
Vertical Deflection	Raised Crosswalk <sup>1</sup>	■	□	▲	▲
	Raised Intersection <sup>1</sup>	▲	□	▲	▲
	Sidewalk Extension	▲	□	■	□
	Speed Hump	■	▲	■	▲
	Textured Crosswalk	□	□	▲	▲
	Speed Cushion	■	▲	■	▲
	Speed Table	■	▲	■	▲
Horizontal Deflection/ Narrowing	Chicane - one lane	■	■	■	▲
	Chicane - two lane	▲	□	▲	▲
	Curb Extension	▲	□	□	■
	Curb Radius Reduction	▲	□	□	▲
	On-street Parking	▲	□	□	▲
	Raised Median Island	▲	□	▲	□
	Traffic Circle, Button, Mini-Roundabout	■	▲	■	■
	Lateral Shift	▲	□	▲	▲
	Speed Kidney	▲	□	□	■
	Lane Narrowing	▲	□	□	■
	Road 'Right-sizing'	▲	□	□	■
Obstruction	Directional Closure	□	■	▲	▲
	Diverter	□	■	▲	▲
	Full Closure	□	■	■	▲
	Intersection Channelization	□	▲	▲	▲
	Raised Median Through Intersection	□	■	▲	▲
	Right-In/Right-Out Island	□	■	▲	▲

Substantial benefits    
  Minor benefits    
  No benefit  
 Minor Measure not in 1998 TAC CGNTC (benefits yet to be verified)

<sup>1</sup> For information on raised crossings refer to section 3.6.4.3

# TRAFFIC CALMING (CONT.)

**3.8** **Table 3.36** provides a summary of the potential disbenefits associated with each measure in terms of local access, emergency response, other travel modes, enforcement, maintenance, and replacement costs.

**Table 3.36** Traffic Calming Measures – Potential Disbenefits (Adapted from 1998 TAC CGNTC Table 3.3)

Measure	Potential Disbenefits						
	Local Access	Emergency Response	Other Travel Modes	Enforcement	Maintenance	Cost	
<b>Vertical Deflection</b>	<i>Raised Crosswalk<sup>1</sup></i>	☐	▲	▲	☐	▲	\$ to \$\$
	<i>Raised Intersection<sup>1</sup></i>	☐	▲	▲	☐	▲	\$\$\$
	<i>Sidewalk Extension</i>	☐	☐	☐	☐	▲	\$
	<i>Speed Hump</i>	☐	▲	▲	☐	▲	\$ to \$\$
	<i>Textured Crosswalk</i>	☐	☐	▲	☐	▲	\$ to \$\$
	<i>Speed Cushion</i>	☐	▲	▲	☐	▲	\$ to \$\$
	<i>Speed Table</i>	☐	▲	▲	☐	▲	\$ to \$\$
<b>Horizontal Deflection/ Narrowing</b>	<i>Chicane - one lane</i>	☐	▲	▲	☐	▲	\$\$ to \$\$\$
	<i>Chicane - two lane</i>	☐	☐	☐	☐	▲	\$
	<i>Curb Extension</i>	☐	☐	▲	☐	▲	\$ to \$\$
	<i>Curb Radius Reduction</i>	☐	☐	☐	☐	▲	\$ to \$\$
	<i>On-street Parking</i>	☐	▲	▲	☐	▲	\$ to \$\$
	<i>Raised Median Island</i>	▲	☐	☐	☐	▲	\$ to \$\$
	<i>Traffic Circle, Button, Mini-Roundabout</i>	☐	▲	▲	☐	▲	\$\$ to \$\$\$
	<i>Lateral Shift</i>	☐	▲	▲	☐	☐	\$ to \$\$
	<i>Speed Kidney</i>	☐	▲	▲	☐	▲	\$ to \$\$
	<i>Lane Narrowing</i>	☐	▲	▲	☐	☐	\$
	<i>Road 'Right-sizing'</i>	☐	▲	■	☐	☐	\$ to \$\$
<b>Obstruction</b>	<i>Directional Closure</i>	▲	☐	▲	▲	▲	\$
	<i>Diverter</i>	▲	▲	▲	☐	▲	\$\$ to \$\$\$
	<i>Full Closure</i>	■	■	▲	☐	▲	\$\$ to \$\$\$
	<i>Intersection Channelization</i>	▲	▲	☐	☐	▲	\$\$ to \$\$\$
	<i>Raised Median Through Intersection</i>	▲	▲	▲	☐	▲	\$ to \$\$
	<i>Right-In/Right-Out Island</i>	▲	▲	▲	▲	▲	\$

\$ Low Cost      \$\$ Moderate Cost      \$\$\$ High Cost  
 ■ Substantial benefits    ▲ Minor benefits    ☐ No benefit  
 ■ Minor Measure not in 1998 TAC CGNTC (benefits yet to be verified)

<sup>1</sup> For information on raised crossings refer to section 3.6.4.3

Sections 3.2 through 3.5 of the 1998 TAC CGNTC provide specific applicability details, benefits, disbenefits, costs, and images associated with all 25 traffic calming measures presented in these tables.



## SHARED STREETS, REVERSE HOUSING LANES, AND ALLEYS

### 3.9

Alleys and Shared Streets are low volume streets that are typically narrower and lower speed, and do not have any public realm elements outside of the Travelled Way. That is, the Travelled Way is a shared space between all users and functions as part of the public realm on these streets. Alleys and Shared Streets serve distinct purposes; an Alley is a low volume street that primarily serves those driving to access a residence or business, a Shared Street is specifically designed to protect those walking and riding bikes. Shared Streets can meet the needs of adjacent residents and businesses, and function foremost as a public space for recreation, socializing, shopping, and leisure.

It is important to note that while a low volume street may not have sidewalks and therefore function like a Shared Street, Shared Street conversions necessitate a conscious redesign rather than the addition of regulatory signage alone. Sidewalks should be added when upgrading substandard neighbourhood streets, especially when space allows.

The design speed limit for Alleys and Shared Streets are identified in Section 3.2.

With the growth of garden and garage suites, there is increasing residential development along alleys and it is expected that alleys will continue to evolve to become even more of a shared resource.

Another development trend within the City is the construction of “reverse” or “greenway” housing, which fronts onto a linear or traditional park space, with access provided from an enhanced Alley. The Alley for these developments provides not only vehicular access to each lot, but also serves to facilitate emergency access, utility connections, walking/cycling connectivity, and in some cases visitor parking.

#### 3.9.1 Shared Streets

An example of a Shared Street is shown in [Figure 3.88](#). In a Shared Street, on-street walking and wheeling facilities exist in multimodal travel environments, so their design and implementation must take into account motor vehicle traffic operations, public realm/roadside zones, crossings for people cycling, walking, and wheeling, and the combined operational characteristics of all travel modes including walking, cycling, and transit.



**Figure 3.88** Shared Street

Effective integration can improve safety for all street users by designing according to the speed differential between users. Generally, as speed differentials increase, separation between users should increase, and conflicting movements should be more strongly controlled and clearly delineated. Shared Streets are at one end of the spectrum: they provide little distinction between the space allocated to people walking and other users, and people driving are obliged to travel at walking speeds.

A Shared Street environment should be considered in places where there are a lot of people walking and vehicle volumes are either low or discouraged. Shared Streets can be designed for narrow or wide cross

## SHARED STREETS, REVERSE HOUSING LANES, AND ALLEYS *(CONT.)*

### 3.9

sections, but become increasingly complex and difficult to maintain as the shared space width increases. Shared Streets are designed to alert users that the space is shared and to slow or discourage people driving from using the space through design elements, which include the following:

- + Textured or pervious pavements that are flush with the curb reinforce to users that a Shared Street prioritizes those walking. Selection of snowplow-compatible materials is required. Drainage channels should be provided either at the centre of the street or along the flush curb, depending on the underground utilities and other existing conditions.
- + Street furniture, including bollards, benches, planters, and bicycle parking, can help define a shared space, subtly delineating the traveled way for vehicles and bicycles from the walking-only space.
- + A Shared Street sign should be used at the entrance to a Shared Street. In some cases, a modified YIELD TO PEDESTRIANS sign (MUTCD-C RB-38) may be added to educate and reinforce the conversion in early stages. However, Shared Streets should generally be designed to operate intuitively as shared spaces without the need for signage. Residential Shared Street signage often depicts children playing to make people driving aware they are entering a low speed area.
- + A tactile warning strip should be provided at the entrance to all shared spaces. Warning strips should alert people walking. Tactile surfaces or textured pavers along a Shared Street are also important to guide people with visual impairments along the corridor within the walking-only area.
- + On wider Shared Streets, staggered blocks of landscaping can be used to create a chicane effect. In some cases, parking may be permitted directly adjacent to properties in a residential environment. Deliveries to businesses are typically restricted to certain hours of the day, usually in the morning. Bollards, paving materials, and street furniture can be utilized to help define parking spaces and to delineate private from public space.
- + On longer Shared Streets (in excess of 100 m), consideration should be given to identifying designated crossing locations to enhance safety for people walking and wheeling and support Universal Design.

Where necessary, traffic volumes can be decreased through network design and traffic calming as part of a conversion. Shared Streets may also be closed to through traffic for specific portions of the day. Movable planters and time-of-day restrictions can be utilized to further regulate the shared space.

Depending on the right of way, designers may consider including a 1.8 m sidewalk, protected from vehicles and cyclists. The sidewalk, or walking-only area, may be defined using planters, bollards, and street furniture, as well as detectable warning strips or textured pavers.

#### *Pedestrian-Only Shopping Street*

Pedestrian-Only Shopping Streets provide opportunities to improve overall network mobility for people walking, but also to create lively public spaces that can be used for public events, markets, and festivals. Bicycles may be permitted, but people cycling should be encouraged to move at walking speeds.

## SHARED STREETS, REVERSE HOUSING LANES, AND ALLEYS *(CONT.)*

### 3.9

Pedestrian-Only Shopping Streets should be designed to accommodate emergency services, though other traffic should be restricted either through clear signage or removable bollards. In general, design of a Pedestrian-Only Shopping Street will be similar to a shared space.

A successful Pedestrian-Only Shopping Street will require innovative urban design to make the space accessible, activated and exciting and should ideally be well served by nearby transit routes.

#### 3.9.2 Alleys and Reverse Housing Lanes

Alleys are low speed residential or commercial streets whose primary function is to facilitate access to adjacent properties. Alleys in urban areas do not typically have defined travel lanes as they are intended to be lower speed streets. Local conditions and practices related to provision of on-street parking, emergency access, waste and recycling collection, and snow storage need to be considered in determining the width of the Travelled Way.

The City has two alley classifications, one for residential alleys and one for commercial alleys. Residential alleys are further divided into typical residential alleys and reverse housing lanes. The standard detail drawings for all Alleys and Lanes can be found in Chapter 3.

Commercial Alleys require paving of the entire Alley right of way to a thicker pavement structure to accommodate loading and delivery vehicle operations. Residential lanes utilize a thinner pavement structure, and typically require a pavement width of 4.0 m, unless there is perpendicular parking immediately adjacent to, and accessed from, the lane. In this case paving of the entire alley right of way may be necessary, at the discretion of the City.

Typical Residential Alleys must be designed to accommodate waste collection vehicles, while reverse housing lanes must accommodate both waste collection vehicles and fire trucks.

Reverse housing lanes utilize a wider right of way compared to a typical residential lane, with a minimum 7.5 m pavement width to accommodate emergency access routing and staging as well as utility installations, and always include street lighting. Additional right of way is also required whenever dedicated sidewalk facilities are provided in reverse housing lanes, or where on-lane visitor parking is proposed.



Figure 3.89 Reverse Housing

# SHARED STREETS, REVERSE HOUSING LANES, AND ALLEYS *(CONT.)*

## 3.9

### 3.9.2.1 Activating Alleys

Alleys take up a lot of space in the urban environment, and this space provides opportunities for placemaking. Making an alley part of a green network, bicycle corridor, or art installation can transform a forgotten alley into an exciting and valuable urban destination.

How to best activate an Alley will depend on the surrounding land use context; Alleys in the downtown core have different opportunities than those located in a low density residential neighbourhood. The keys of a successful Alley include:

- + Quality public space that are part of the identity of the city and with spaces to enjoy;
- + Ecological elements that include plants and contribute to the insect and bird habitat; and,
- + Safe for all people.

Simple interventions to improve alleys include:

- + Paving – combination of brick pavers with higher quality material to accommodate heavy trucks;
- + Lighting;
- + Canopies;
- + Plants;
- + Opening facades or eyes on the street;
- + Identity (unique characteristics);
- + Concealing or fencing off waste collection areas;
- + Street furniture; and/or
- + Considerations for snow clearing and drainage.

Alley housing (also known as Garden Suites) also has the potential to activate Residential Alleys by creating housing that faces the Alley and encourages people walking and cycling in Alleys.



Figure 3.90 Activated Alley

## SHARED STREETS, REVERSE HOUSING LANES, AND ALLEYS *(CONT.)*

### 3.9

#### 3.9.2.2 *Width*

The City of Edmonton has developed four Alley classifications, which can be found in Chapter 3:

- + 4.0 m Wide Residential Alley;
- + 6.0 m Wide Commercial Alley;
- + 7.5 m Wide Reverse Housing Alley; and
- + 9.5 m Wide Reverse Housing Alley with Parking.

#### 3.9.2.3 *Culs-de-Sac & Turnarounds*

A cul-de-sac or turnaround is required to terminate an Alley, as shown on the standard detail drawings in Chapter 3. Alley culs-de-sac in new developments are not permitted without specific authorization from the City.

#### 3.9.2.4 *Horizontal Alignment*

Alleys shall be centered on the Alley right of way wherever possible. A 3 m fillet shall be constructed at the corners of all Alley to Alley intersections. The length of an Alley from the nearest street access cannot exceed 120 m. Where lengths exceed 120 m, a secondary access must be provided.

#### 3.9.2.5 *Vertical Alignment*

The vertical alignment of an Alley adjacent and parallel to Collector or Arterial streets shall be designed in conjunction with the grades on the adjacent streets and abutting lots. The minimum longitudinal grade for new Alley construction is 0.7%. Though this may not be achievable in retrofit situations, efforts to maximize longitudinal grades while respecting adjacent property lot grading shall be made.

## TEMPORARY ROADS AND TURNAROUNDS

### 3.10

A Temporary Road may be required for a number of reasons. For example, a temporary access may be required in a partially built community before a permanent, approved access is constructed. Temporary turnarounds are also necessary to enable large vehicles and buses to egress when there is no through connection due to staging or construction. A Temporary Road may also be required as a detour during a major infrastructure construction project (e.g. interchange), and should be designed to accommodate displaced traffic while ensuring safety for all street users.

When it has been determined by the City that a Temporary Road is required in a new subdivision, the road shall be built in accordance with plans approved by the City in accordance with the standard detail drawing in Chapter 3, with all costs thereof borne by the Developer.

A Temporary Road between a proposed subdivision and an existing Local or Collector street which is required as a point of access shall be constructed to one of the following standards:

- ✦ The road be gravel surfaced or constructed to the completed paving stage, and may required lighting at the discretion of the City and as specified as the subdivision approval stage. A Temporary Road constructed through or flanking a single family lot shall have screen fencing provided to buffer the adjacent development, and a sign indicating the temporary nature of the road shall be erected.
- ✦ When the Temporary Road will be used only by construction traffic and will be taken out of service before residential occupancy of the subdivision following the construction of permanent access points, the road shall be constructed to the interim gravel stage without curbs and gutters. When the

Temporary Road crosses the curbs, gutters, and sidewalks/shared pathways of adjoining streets, provision shall be made to permit regular vehicle movement across the curbs;

- ✦ Where a Temporary Road will be used only for emergency access, and will not ultimately be required with completion of the development, the road shall be constructed to the interim gravel stage without curb and gutters. Signage shall be installed at either end of the temporary road to restrict use to emergency vehicles; and
- ✦ Where a street terminates at mid-block and has no provision for egress, a temporary circular turnaround shall be constructed to the same structure as the abutting street and shall be designed with a minimum 12 m radius on a local/ collector (without transit) or a 17 m radius on a collector/arterial (with transit). All temporary turnarounds are required to be constructed at a gravel stage prior to opening the road to public access. If the turnaround is to be used by transit it may be required to be paved to an asphalt hard surface standard prior to opening the roadway at the discretion of the City. A temporary turnaround is not required where the roadway termination is easily visible from the adjacent intersection (a two lot maximum distance).
- ✦ Where temporary roads connect to existing infrastructure, impacts on existing trees shall be minimized. Where trees cannot be avoided, removal must occur in accordance with the City's live tree removal guidelines.

Temporary Roads shall be shown on detailed engineering drawings, and must include vertical and horizontal alignments, drainage details, and typical cross sections.

## VEHICULAR BARRIERS

### 3.11

In some situations, a measure of physical protection may be required between the Travelled Way and urban area public realm or non-urban area roadside to protect against crashes between motor vehicle traffic and adjacent buildings, people walking and cycling, and elements located within the public realm/roadside.

Examples of such cases could include:

- + A barrier adjacent to a school boundary or property to minimize potential vehicle contact;
- + Shielding businesses or residences near the right of way where there is a history of run-of-the road collisions, particularly along streets with low radius curves; and,
- + Where provisions for a shared pathway are included so that people biking do not have to ride on high speed streets, but horizontal separation to the Travelled Way is limited due to right of way constraints.

In these cases and others, conventional criteria will not serve to provide warrants for barriers, and the designer must be aware of the needs and circumstances of the individual situation when deciding on appropriate action.

Barriers are also appropriate for the protection and separation of people walking and cycling along streets with high motor vehicle traffic speeds and/or volumes. Specific design guidance is provided in the following TAC GDG Sections:

- + Section 5.3.1 – Protected Bike Lanes;
- + Section 5.4 – Bikeway Facility Selection;

- + Section 5.7.5 – Protected Bike Lane Delineators;
- + Section 6.5.5 – Pedestrian Safety Fencing and Barriers; and
- + Section 7.6.4.3 – Multimodal Configurations (of Bridges).

#### 3.11.1 Barrier Posts

Vehicular barriers (barrier posts) are to be constructed as shown on Drawings 6200/6220 or as approved by the City and are required at the following locations:

- + Across the end of a of-street paths/trails which terminates in an Alley;
- + Across the end of an Alley cul-de-sac which abuts a street;
- + Along the length of an Alley which parallels an adjacent street; and
- + Along the length of an Alley which parallels a park area, public utility lot, utility corridor, or stormwater management facility

#### 3.11.2 Roadside & Median Barriers

For guidance on roadside barriers, median barriers, bridge railings, and end treatments, for non-urban, higher-speed roadways refer to TAC GDG Section 7.6: Trafic Barriers. Barriers as they relate to roadside in non-urban areas are discussed in Section 3.4.2 of this document.

## CUL-DE-SAC

### 3.12

Sidewalks will be required in culs-de-sac as described below and as shown on the standard detail drawing in Chapter 3:

- ✦ Culs-de-sac with 10 or fewer lots fronting and/or fanking the cul-de-sac do not require a sidewalk;
- ✦ Culs-de-sac with fewer than 19 lots and less than 120 m only require a sidewalk on one side;
- ✦ Culs-de-sac with 18 or more lots fronting and/or fanking the cul-de-sac require a sidewalk on both sides; and,
- ✦ Culs-de-sac with sidewalk connection to a walk or trail system will require sidewalk on both sides, regardless of the number of lots.

Islands in culs-de-sac shall be designed to allow minimum turning movements of passenger vehicles and waste collection vehicles, plus sufficient width for parallel parking. Minimum Travelled Way widths must comply with the standard detail drawings in Chapter 3.

Cul-de-sac islands should be landscaped to accommodate winter snow storage. The islands may be permitted to use straight face curb and reverse gutter with a 500 mm monolithic concrete header, and a standard street cross-fall of 0.025 m/m.



## INDUSTRIAL STREETS

### 3.13

The following provides guidance for the design of streets in Industrial Areas. While it incorporates the Complete Streets Principles and considerations from Section 1, the design process outlined in Section 2, and the Design Users and Human Factors in Section 3.1, the industrial area context necessitates additional considerations.

#### 3.13.1 Industrial Area Context

Industrial areas are districts which can reflect highly varied land use characteristics, including office parks, retail uses, small manufacturing establishments, warehouses, large manufacturing establishments, and intensive industrial plants. Although the Zoning Bylaw includes distinctions between typical industrial zones (that may result in different types of business) and their associated transportation needs, many different types of end users can be found in each land use zone. The variety in business type and transportation requirements makes it difficult to predict the precise character and resulting streetscape which should be associated with any given industrial zone. The fact that industrial areas, particularly older districts, show highly fragmented zoning patterns, increases the variation of building type and associated end user to be found on any given street or block. Over time, the type of businesses and their associated transportation needs may change, which requires industrial area streets to be designed to accommodate a wide range of transportation access and mobility needs.

The transportation needs for industrial areas vary based on the business operations. Some businesses will require access for large vehicles while other businesses, such as office parks, may be more focused on employee and client multi-modal personal access. In many cases, industrial areas are developed with

non-street oriented buildings, which is a consideration when designing the transportation system. In general, the following transportation requirements need to be considered for streets in industrial areas:

- ✦ Business-related movements including the movement of heavy vehicles for businesses such as shipping and manufacturing;
- ✦ Employee access including all modes and consideration of equity and accessibility; and
- ✦ Customer access, which may include a variety of motorized and non-motorized modes and can include heavy vehicles.

#### 3.13.2 Industrial Area Modal Priority & Design Users

Streets in industrial areas are High Priority Goods Movement corridors. This means streets in industrial areas are designed based on the access requirements for heavy vehicles and large trucks. Design vehicles are described in more detail in Section 3.1.3.

While walking, transit, and cycling are not high priority modes in industrial areas, designing streets to accommodate multimodal connectivity on a network level, including access for walking and cycling, is still a requirement for industrial areas. Demand and all-day use of walking and cycling infrastructure, including walking/cycling connections to transit, may be limited, but providing walk/bike/transit access to industrial area businesses provides employees of all abilities and incomes with an affordable and safe option to get to and from work. Design Users for walking/wheeling, cycling, and transit are also outlined in Section 3.1.3. Based on the Design User, facilities for walking and cycling should be separated from motor vehicle travel lanes.

## INDUSTRIAL STREETS (CONT.)

### 3.13

#### 3.13.3 Industrial Area Cross Section Types

Due to the non-street oriented context of industrial areas, there are three types of street cross sections that can be used:

- + Urban: curb and gutter, underground drainage;
- + Rural: over land drainage with ditches, may include centre median with curb and gutter; and
- + Urban-Rural Hybrid: one side of the street is urban and the other is rural.

Considerations for which type of cross section is most appropriate will include:

- + Number of accesses: rural or hybrid cross sections will require culverts at driveways/accesses and intersections;
- + On-street parking: rural and hybrid cross sections (the rural side) will not support on-street parking due to lack of sidewalk access and the presence of side slopes;
- + Developable land restrictions: rural and hybrid cross sections (the rural side) may require easements on private land to reduce the public right of way, or alternatively will require wider right of way compared to urban cross sections. These easements restrict development within them or use of the area for parking or signage;

- + Access to bus stops: rural and hybrid cross sections (the rural side) will require culverts for transit passengers at bus stops and should include connections to the sidewalk or shared pathway beyond the backslope;
- + Active transportation facilities: rural and hybrid cross sections (the rural side) will require sidewalks or shared pathways beyond the back slope to support all-seasons operation of the street and active transportation infrastructure; and
- + Lighting: rural and hybrid cross sections (the rural side) may require additional lighting to illuminate both the Travelled Way and off-street public realm where the active transportation facilities are located away from the street.

#### 3.13.4 Industrial Area Design Requirements

**Table 3.37** summarizes the design requirements for streets in industrial areas. Design should be completed in accordance with the requirements set out in this document and the requirements outlined in the City's Design and Construction Standards Volumes 3, 4, 5, 6, and 7 on Drainage, Water, Landscaping, Street Lighting, and Power, Respectively.

Standard details for urban and rural industrial streets can be found in Chapter 3.

## INDUSTRIAL STREETS (CONT.)

### 3.13

**Table 3.37:** Industrial Area Street Design Requirements

Cross Section Element	Industrial Arterial	Industrial Collector	Industrial Local
Shoulder	Yes - for rural and hybrid cross sections	Yes - for rural cross sections	Yes - for rural cross sections
Travelled Way & Intersection Geometry	Based on Design Vehicle (Section 3.1.3)	Based on Design Vehicle (Section 3.1.3)	Based on Design Vehicle (Section 3.1.3)
On-street Parking	No	Yes - for urban cross sections No - for rural cross sections	Yes - for urban cross sections No - for rural cross sections
Active Transportation Infrastructure	Shared path both sides  Located beyond back slope for rural and hybrid cross sections  Crossings and sidewalk connections provided to all bus stops	shared pathway one side  Located beyond back slope for rural cross sections  Crossings and sidewalk connections provided to all bus stops (including on the side of street without shared pathway)	shared pathway one side (2.5 m due to low anticipated volumes)  Located beyond back slope for rural cross sections
Transit Stops Stops typically not provided on Local streets	Stops provided with amenities determined by Edmonton Transit (e.g., shelters, benches)	Stops provided with amenities determined by Edmonton Transit (e.g., shelters, benches)	Stops typically not provided on Local streets
Landscaping	Per landscaping standards	Per landscaping standards	Per landscaping standards
Utilities	All utilities underground	All utilities underground	All utilities underground

## WILDLIFE PASSAGES

### 3.14

The City's "Wildlife Passage Engineering Design Guidelines, June 2010" provides Designers with recommendations that incorporate the needs of wildlife into transportation projects. The two primary objectives of the Guideline are:

1. To maintain habitat connectivity and reduce genetic isolation among Edmonton's wildlife populations so that these communities continue to fulfill their ecological, social and economic functions; and,
2. To aid in the reduction of human wildlife conflict and improving awareness, safety, and reducing collisions.

Detailed guidelines can be referenced as follows:

- + Section 3.0: Planning Guidelines;
- + Section 4.0: Design Guidelines; and,
- + Section 5.0: Maintenance & Operations Guidelines.

The design of any street must take into consideration potential wildlife passage requirements to reduce conflicts between street users and wildlife, and to wildlife improve habitat.

## REFERENCES

### 4.0

References that provide guidance for the CSDCS are noted throughout the document within the text and as footnotes as and where relevant. In addition, the following documents are important supplementary references for designing Edmonton streets and transportation facilities:

- + Access Management Guidelines, City of Edmonton, 2013
- + Accessible Design for the Built Environment, CSA, 2004
- + Bikeway Traffic Control Guidelines for Canada, TAC, 2012
- + Canadian Guide to Neighbourhood Traffic Calming, TAC, 1999
- + Canadian Roundabout Design Guide, TAC, 2017
- + Design Manual for Bicycle Traffic, CROW, 2016
- + Design and Construction Standards, City of Edmonton
  - + Volume 1: General
  - + Volume 3: Drainage
  - + Volume 4: Water
  - + Volume 5: Landscaping
  - + Volume 6: Street Lighting
  - + Volume 7: Power
  - + Volume 8: Pavement Marking
- + Designing for All Ages & Abilities - Contextual Guidance for High-Comfort Bicycle Facilities, NACTO, 2017
- + Effective Engineering Measures That Address Speeding Issues on Residential Roadways in Edmonton, CIMA+/City of Edmonton, 2013
- + Geometric Design Guide for Canadian Roads, TAC, 2017
- + Guide for the Design of Roadway Lighting, TAC, 2006
- + Highway Geometric Design Guide, Alberta Transportation, 2015
- + Main Streets Guideline, City of Edmonton, 2016
- + Manual for Uniform Traffic Control Devices for Canada (MUTCD-C), TAC, 2014
- + Metric Curve Tables, TAC, 2017 + Transit Oriented Development Guidelines, City of Edmonton, 2012
- + Transportation System for the City of Edmonton Bylaw, City of Edmonton
- + Wildlife Passage Engineering Design Guidelines, City of Edmonton, 2010
- + Winter Design Guidelines, City of Edmonton, 2016

## ABBREVIATIONS

### 5.0

AASHTO	American Association of State and Highway Transportation Officials	m	Meters
ARP	Area Redevelopment Plan	mm	Millimeters
ASP	Area Structure Plan	MSG	Main Streets Guideline (City of Edmonton)
Austrroads	Association of Australian and New Zealand Road Transport and Traffic Authorities	MTO	Ministry of Transportation Ontario
BIA	Business Improvement Area	MUTCD-C	Manual of Uniform Traffic Control Devices for Canada (TAC)
CGNTC	Canadian Guide for Neighbourhood Traffic Calming (TAC)	N/A	Not Applicable
City	City of Edmonton	NACTO	National Association of City Transportation Officials
CSA	Canadian Standards Association	NCHRP	National Cooperative Highway Research Program
CSDCS	Complete Streets Design and Construction Standards (City of Edmonton)	NSP	Neighbourhood Structure Plan
DSD	Decision Sight Distance	Province	Province of Alberta
FHWA	Federal Highway Administration	PUL	Public Utility Lot
GDG	Geometric Design Guide for Canadian Roads (TAC)	SSD	Stopping Sight Distance
h	Hour	SUP	shared pathway
ICD	Inscribed Circle Diameter	SWMP	Stormwater Management Facility
km	Kilometres	TAC	Transportation Association of Canada
km/h	Kilometres per hour	TOD	Transit Oriented Development
LID	Low Impact Drainage	TWSI	Tactile Walking Surface Indicator
LRT	Light Rail Transit	veh/day	Vehicles per Day
		WDG	Winter Design Guidelines (City of Edmonton)

## APPENDICES

**APPENDIX A** Complete Streets Principles

**APPENDIX B** Sample Design Exception Form

**APPENDIX C** Summary of Geometric Design Standards

**APPENDIX D** Right Turn Design Matrix

**APPENDIX E** Sidewalk, Walkway, and Pathway Requirements

**APPENDIX F** List of Design Tables



## APPENDIX A: COMPLETE STREETS PRINCIPLES

The Complete Streets Principles are listed below, along with several bullets providing additional guidance on how each of the Principles can improve the completeness of streets in Edmonton. These represent design ideas that are not mandatory, but help to illustrate what implementation of the Principles could look like.

***A network of streets, transitways, and of-street pathways together accommodate all users and allow for efficient and high quality travel experiences.***

Implementation of this principle will generally improve completeness of streets by:

- ✦ Reflecting the character, scale and needs of the neighbourhood and surrounding area. That is, not all complete streets will look identical; some streets may need to accommodate all modes, while others may accommodate a more limited range of modes.
- ✦ Considering and evaluating the tradeoffs between efficiency and quality of journey for each mode
- ✦ Including all streets: new streets and streets that require rehabilitation/renewal, repair/maintenance, or operational review
- ✦ Including all streets in locations (residential, commercial / mixed use, industrial, and institutional) and for all functional types (freeways, arterials, collectors, locals, alleys)

***The transportation network provides travel options for users of all ages and abilities that are safe, universally designed, context sensitive, and operable in all seasons (including winter).*** Implementation of this principle will generally improve completeness of streets by:

- ✦ Allowing safe travel by all modes (pedestrian, bicyclists, transit, goods movement, automobiles) to connect destinations (homes, community gathering places, businesses, shopping, schools, work places, parks, recreation, and transit)
- ✦ Supporting active lifestyles for people of all ages and abilities (including barrier-free, age-friendly, and universal design).
- ✦ Providing appropriate access for waste removal, emergency vehicles, trucks and snow and ice control equipment that recognizes the need to balance the many users of a road.
- ✦ Considering the maintenance and operational requirements in all seasons based on the context and users.

***Streets are adaptable by accommodating the needs of the present and future.*** Implementation of this principle will generally improve completeness of streets by:

- ✦ Anticipating implementation over a period of time, based on a clear framework for street design elements that guides how and where to achieve the most progress
- ✦ Considering the appropriate amount of street right of way required today and in the future to support the adjacent communities
- ✦ Considering flexibility to incorporate innovative and progressive design features
- ✦ Providing places for basic elements in the street such as transit stop pads, utilities, fire hydrants, on street parking, technology such as Intelligent Transportation Systems, and lighting.

## APPENDIX A: COMPLETE STREETS PRINCIPLES (CONT.)

***Streets contribute to the environmental sustainability and resiliency of the city.*** Implementation of this principle will generally improve completeness of streets by:

- + Encouraging and facilitating a shift towards sustainable modes of transportation
- + Enabling reduced stormwater runoff, greenhouse gas emissions, other pollution, and energy consumption

***Consider both direct and indirect costs, as well as the value of the public right of way and the adjacent real estate.*** Implementation of this principle will generally improve completeness of streets by:

- + Being cost effective to build, maintain and operate by considering the costs and trade-offs to taxpayers, developers, home buyers, the City, and utility companies.
- + Being mindful of health, safety, collision, emission, and urban design costs
- + Recognizing the appropriate cost of urban design elements and requirements for on-street parking will vary depending on the context.
- + Supporting streets as destinations; for example, vibrant shopping areas
- + Accommodating trucks in industrial areas and on key goods movement routes.

***Streets are vibrant and attractive people places in all seasons to contribute to an improved quality of life.***

Implementation of this principle will generally improve completeness of streets by

- + Creating spaces that encourage citizens to interact with each other and their surroundings in all seasons through provisions such as wider sidewalks in the appropriate context.
- + Considering attractive urban design elements, public art, street trees, street furniture and decorative lighting while reducing visual clutter in the appropriate context.
- + Contributing to a sense of personal security



## APPENDIX B: SAMPLE DESIGN EXCEPTION FORM

### Project Information:

Project Name:	
Project Limits:	
Project Type:	
Submission Date:	
Approval Date:	

### Design Exception Information:

Location:	Where will the design exception apply (e.g., north side of street between cross roads; intersection; intersection quadrant; neighbourhood, etc.)? Include a site plan as an attachment.		
Context:	What is the context (e.g. adjacent land use and orientations, street classification, design and posted speed, truck route, modal priority, anticipated volumes)?		
Exception Requested:	What design element or combination of elements is the design exception for (e.g. curb radius; lane width; sidewalk width; etc.)? What is the proposed value? What is the range of values in the standards?		
Rationale:	What is the rationale for the design exception? Include any supporting drawings (e.g.i.e., swept path analysis, cross sections, etc.) as an attachment page(s).		
Alternatives Considered:	What alternatives (if any) were considered in the decision? What is the benefit of and what are the impacts avoided with the identified solution over other alternatives considered?		
Risks and Mitigation:	What are the potential risks associated with this exception and what is being done to mitigate them (e.g.,i.e., signage, vehicle restrictions, etc.)? What additional mitigation measures are being included to offset potential impacts of the exception?		
Safety Risk	<input type="checkbox"/> Marginal	<input type="checkbox"/> Nominal	<input type="checkbox"/> Substantive
Supporting Information:	What (if any) additional supporting data or technical resources were used in making the decision (ie.g.,.e. research papers, emerging best practice, new guidelines, etc.)?		

### Submitted by:

Name:	
Title/Company:	
Date:	

### Approved by:

Name:	
Title/Company:	
Date:	

## APPENDIX C: SUMMARY OF GEOMETRIC DESIGN STANDARDS

Classification	Suggested Design speed (km/h)	Minimum centreline curve radii <sup>1</sup>	Super elevation	Minimum horizontal curve lengths	Maximum gradient <sup>2,6</sup>	Minimum gradient <sup>3,6</sup>	Minimum tangent section lengths	Minimum Intersection spacing
Local								
Residential Local	50	90 m	No	60 m	8%	0.6%	30 m	60 m
Industrial Local	50	90 m	No	60 m	8%	0.6%	60 m	60 m
Residential Service Road	50	90 m	No	60 m	8%	0.6%	30 m	60 m
Industrial Service Road	50	90 m	No	60 m	8%	0.6%	30 m	60 m
Collector								
Residential Collector (One Lane Each Direction)	50	120 m	No	60 m	8%	0.6%	60 m	60 m
Residential Collector (Two or More Lanes Each Direction)	50	130 m <sup>4</sup>	Optional	60 m	8%	0.6%	60 m	60 m
Industrial Collector	50	130 m <sup>4</sup>	Optional	60 m	8%	0.6%	60 m	60 m
Arterial								
5-Lane Undivided Arterial	50 or 70	190 m <sup>4</sup>	Yes <sup>5</sup>	TAC GDG	6%	0.6%	TAC GDG	200 m
4-Lane Divided Arterial	50 or 70	190 m <sup>4</sup>	Yes <sup>5</sup>	TAC GDG	6%	0.6%	TAC GDG	200 m
6-Lane Divided Arterial	50 or 70	190 m <sup>4</sup>	Yes <sup>5</sup>	TAC GDG	6%	0.6%	TAC GDG	400 m
Walkways & Bikeways								
Walkways	N/A	N/A	N/A	N/A	5%	0.6%	N/A	N/A
shared pathways (or Bike Path)	30	24 m	N/A	N/A	5%	0.6%	N/A	N/A
Alleys								
Residential Alleys	N/A	N/A	N/A	N/A	10%	0.7%	N/A	N/A
Commercial Alleys	N/A	N/A	N/A	N/A	10%	0.7%	N/A	N/A

## APPENDIX C: SUMMARY OF GEOMETRIC DESIGN STANDARDS (CONT.)

Classification	Suggested Design speed (km/h)	Minimum centreline curve radii 1	Super elevation	Minimum horizontal curve lengths	Maximum gradient 2,6	Minimum gradient 3,6	Minimum tangent section lengths	Minimum Intersection spacing
Rural Roads								
Rural Local or Collector	80	230 m	Yes <sup>5</sup>	TAC GDG	6%	N/A	TAC GDG	200 m
Temporary Roads								
Access/Detour Road	N/A	90 m	No	60 m	8%	N/A	30 m	N/A

**Notes:**

1. Larger curve radii should be used wherever possible
2. Dependent on topography and access locations may restrict sightlines accordingly.  
Wherever possible, maximum gradients should be kept to under 5% to provide accessibility to the widest range of street users.
3. Minimum gradient on curb radii < 20 m shall be 0.8%
4. Preferred curve radius is 500 m
5. For Superelevation, refer to Section 3.2.6.2
6. Please see section 3.2.7.1 for details on target maximum gradients.

# APPENDIX D: RIGHT TURN DESIGN MATRIX

Factors for Consideration	Design Options					Additional Data
	No-Island		High Entry Angle (Aussie)		Low Entry Angle -free Flow	
	No-Encroachment	With Some Encroachment	No-Encroachment	With Some Encroachment		
<b>ROAD CHARACTERISTICS</b>						
Downstream Conditions						
Far side bus stop	Yes	Possibly <sup>1.5</sup>	Yes	Possibly <sup>1.5</sup>	No	
Downstream Access	Yes	Yes	Possibly <sup>1.5</sup>	Possibly <sup>1.5</sup>	No	
Receiving Street Standard						
Freeway	No	No	No	No	Yes	
Arterial	Yes	Possibly <sup>1.5</sup>	Yes	Possibly <sup>1.5</sup>	Yes	
Collector	Yes	Yes	Yes	Yes	No	
<b>TRAFFIC CHARACTERISTICS</b>						
Right Turn/Cross Street Volume						
High/High (>300 per lane/>600 per Lane)	Possibly <sup>3</sup>	No	Possibly <sup>4</sup>	No	Yes	Turning movement counts
High/Low (>300 per lane/<600 per lane)	Yes	Possibly <sup>1</sup>	Yes	Possibly <sup>1</sup>	Possibly <sup>6</sup>	Turning movement counts
Low/High (<300 per lane/>600 per lane)	Yes	No	Yes	No	Possibly <sup>6</sup>	Turning movement counts
Low/Low (<300 per lane/<600 per lane)	Yes	Yes	Yes	Yes	Possibly <sup>6</sup>	Turning movement counts
Traffic Composition						
Designated Truck Route or High Volume of Turning Trucks (>20 turns in the peak hour)	Possibly <sup>7</sup>	No	Possibly <sup>7</sup>	No	Yes	Truck volumes
Low Volume of Turning Trucks (<20 turns in the peak Hour)	Possibly <sup>7</sup>	Possibly <sup>1</sup>	Possibly <sup>7</sup>	Possibly <sup>1</sup>	Yes	Truck volumes

# APPENDIX D: RIGHT TURN DESIGN MATRIX (CONT.)

Factors for Consideration	Design Options					Additional Data
	No-Island		High Entry Angle (Aussie)		Low Entry Angle -free	
	No-Encroachment	With Some Encroachment	No-Encroachment	With Some Encroachment	No-Flow	
Impact on Traffic Signal Operation						
Te increased crossing distance for people walking/wheeling results in Intersection capacity breakdown with 2044 volumes	Possibly <sup>8</sup>	Possibly <sup>8</sup>	Yes	Yes	Yes	2044 Volumes, Signal data
Te increased crossing distance for people walking/wheeling does not have significant impact on intersection capacity with 2044 volumes	Yes	Yes	Yes	Yes	Yes	2044 Volumes, Signal data
PEDESTRIAN/VULNERABLE ROAD USER CHARACTERISTICS						
Pedestrian Activity						
Low Crossing Volume (< 20 peds/peak hour on two crosswalks meeting at the corner considered)	Yes	Yes	Yes	Yes	Yes	Pedestrian Volumes
Moderate Crossing Volume (20-40 peds/peak hour on two crosswalks meeting at the corner considered)	Possibly <sup>8</sup>	Possibly <sup>8</sup>	Yes	Yes	Possibly <sup>10</sup>	Pedestrian Volumes
High Crossing Volume (>40 peds/peak hour on two crosswalks meeting at the corner considered)	Yes	Yes	Yes	Yes	Possibly <sup>10</sup>	Pedestrian Volumes

## APPENDIX D: RIGHT TURN DESIGN MATRIX (CONT.)

Factors for Consideration	Design Options					Additional Data
	No-Island		High Entry Angle (Aussie)		Low Entry Angle -free No- Flow	
	No-Encroachment	With Some Encroachment	No-Encroachment	With Some Encroachment		
Land Uses near Intersection						
Schools, senior residences	Possibly <sup>9</sup>	Possibly <sup>9</sup>	Yes	Yes	Possibly <sup>10</sup>	
Shopping Centres, Commercial Stores	Yes	Yes	Yes	Yes	Possibly <sup>10</sup>	
Industrial (Low walking/ wheeling activity)	Yes	Possibly <sup>5</sup>	Yes	Possibly <sup>5</sup>	Yes	
Office	Yes	Yes	Yes	Yes	Possibly <sup>10</sup>	

*Possibly<sup>1</sup> - If truck volumes are significantly low, some encroachment may be allowed*

*Possibly<sup>2</sup> - Complying with the City's access management policy*

*Possibly<sup>3</sup> - May need to consider dual right turn lanes; this may require banning right turn on red. Impact of these changes on overall signal operation and capacity should be considered.*

*Possibly<sup>4</sup> - May be possible with dual right turn lanes.*

*Possibly<sup>5</sup> - Depending on the cross street volumes, allowing some encroachment may be possible.*

*Possibly<sup>6</sup> - Tis option should only be considered if the other options are not feasible*

*Possibly<sup>7</sup> - No encroachment design may result in undesirably wide lanes that may encourage passenger cars to use the facility as if it had two lanes; to discourage this behavior, mountable curbs or other effective physical measures should always be used to delineate the desired path to a reasonable width at the merge point.*

*Possibly<sup>8</sup> - Increase crossing time may result in capacity breakdown*

*Possibly<sup>9</sup> - No Island design would increase the crossing distance for people walking and wheeling and thereby exposure to traffic. However, it results in lower speed for turning vehicles compared to other two design options. Tese conditions needs to be taken into account when a decision is made to implement no-Island design.*

*Possibly<sup>10</sup> - Consider mitigating measures to improve safety for people walking and wheeling (e.g., moving crosswalk to the upstream half of the island to improve visibility and the location where vehicle speed is minimal).*

## APPENDIX E: SIDEWALK, WALKWAY, AND PATHWAY REQUIREMENTS

<i>Facility</i>	<i>Location</i>	<i>Monolithic or Separate</i>	<i>Material</i>	<i>Width</i>
Sidewalk	Local	Monolithic	Concrete	1.8 m
Sidewalk/Walkway	Local/Collector/Arterial or Walkway Lot	Separate	Separate	1.8 m
Sidewalk	Adjacent to School Site	Monolithic	Monolithic	2.5 m
Sidewalk	Arterial	Monolithic <sup>1</sup>	Monolithic <sup>1</sup>	2.3 m
Shared Pathway	Emergency Access, Utility Lot, Walkway Lot (10 m in width)	Separate	Separate	3.0 m
Shared pathway	SWMF or Utility Lot (other than 10 m in width)	Separate	Separate	3.0 m
Shared pathway	Arterial	Separate	Separate	3.0 m
Granular Walkway	Top of Bank & SWMF (where identified in NSP and NAMP)	N/A	N/A	1.8 m
Granular Walkway	TUC	N/a	N/A	3.0 m

**Notes:**

1. Monolithic sidewalks along arterial streets are permitted only as a last resort in constrained situations where no other measures are possible to construct a separate walk and require approval from the City.

# APPENDIX F: LIST OF DESIGN TABLES

**Table 3.1** Design Domain for People Walking and Wheeling (in m)

Parameter: Operating Envelope	Recommended Values	
	Horizontal Operating Envelope	Vertical Operating Envelope
Person Walking	0.75	2.10
Manual Wheelchair or Scooter	0.90	2.10
Person Walking with Child / Person Walking with Service Animal / Two People Walking / Two Wheel-chair Users Passing	1.80	2.10

**Table 3.2** Design Domain for People Cycling (in m)

Parameter: Operating Envelope	Recommended Values	
	Recommended Lower Limit	Recommended Upper Limit
Horizontal Operating Envelope	1.2	1.5
Lengthwise Operating Envelope	1.8	3.0
Vertical Operating Envelope	2.5	N/A

**Table 3.3** Design Vehicles by Context

Street Classification	Design Vehicle	Control Vehicle <sup>2</sup>	Control Vehicle Allowable Encroachments
Pedestrian Only Streets & Shared Streets	Bicycle	FT	FT must maneuver within hard surfaced areas with 0.3 m clearance to pavement edge and any vertical obstacles.
Reverse Housing Lane	P	WT, FT	WT, FT must maneuver within hard surfaced areas with 0.3 m clearance to pavement edge and any vertical obstacles.
Alley	P	WT	WT must maneuver within hard surfaced areas with 0.3 m clearance to pavement edge and any vertical obstacles.
Local (Non-Industrial)	P	WT, FT, MSU	Maneuver within hard surfaced areas with 0.3 m clearance to pavement edge and any vertical obstacles.
Collector (Non-Industrial)	B-12	WT, FT	Maneuver within hard surfaced areas with 0.5 m clearance to pavement edge and any vertical obstacles.
Arterial <sup>1</sup> (Non-Truck Route <sup>3</sup> or Truck Route <sup>3</sup> within Mature Neighbourhood Overlay)	B-12	WB-21	Encroachment into adjacent lanes in same direction at major intersections (opposing lanes at minor intersections)
Main Streets <sup>1</sup>	MSU	B-12	Encroachment into non-curb side lanes in same direction on receiving street permitted.
Industrial Local	WB-21	WB-36	Encroachment into opposing lanes permitted at intersections (local/collector)
Industrial Collector	WB-21	WB-36	Encroachment into opposing lanes permitted at intersections (local/collector)
Arterial <sup>1</sup> (Truck Route <sup>3</sup> Outside of Mature Neighbourhood Overlay <sup>4</sup> )	WB-21	WB-36	Encroachment into adjacent lanes in same direction permitted at major intersections (opposing lanes at minor intersections)
Freeways/Expressways	WB-21	WB-36	Encroachment into adjacent lanes in same direction at ramp intersections only.



# APPENDIX F: LIST OF DESIGN TABLES

### Legend (Design, Control Vehicles):

- P = Passenger Car;
- MSU = Medium Single Unit Truck;
- FT = City of Edmonton Fire Truck;
- WT = City of Edmonton Waste Collection Truck;
- B-12 = Standard Single Unit Bus;
- WB-21 = Semi-Trailer (Alberta Transportation); and
- WB-36 = Turnpike Double (Alberta Transportation).

### Notes:

1. Where a Main Street is a truck route, the design requirements for a Main Street shall govern.
2. Minimum 6.0 m clear width required to accommodate FT operations. This must be provided where FT is a control vehicle and can be

accommodated by including the width of opposing lanes, as well as parking lanes on local streets.

5. For Truck Routes refer to the latest City of Edmonton Truck Route Map.
6. For Mature Neighbourhood Overlay refer to the latest City of Edmonton Mature Neighbourhood Overlay map.

Should a designer select a Design or Control Vehicle that is different than those listed in **Table 3.3**, a Design Exception is required.

For further information and details on the above Design Vehicles and other potential Design Vehicles, refer to TAC GDG Section 2.4 (e.g., articulated buses).

**Table 3.4** Design Domain for Design Speeds & Posted Speeds (in km/h)

Contextual Street Classification (building relationship to the street, land use, and functional classification)	Design Domain Recommended Range		City of Edmonton Target Value	
	Recommended Lower Limit	Recommended Upper Limit	Design Speed	Posted Speed
Alleys, Reverse Housing Lanes, Shared Streets, and Pedestrian Only Street (all contexts)	5	20	20 <sup>2</sup>	20 <sup>2</sup>
Local Streets (all contexts except Industrial)	30	40	50 <sup>2</sup>	50 <sup>2</sup>
Local Industrial Streets	30	50	50	50
Street Oriented Collector Streets (all land use contexts)	30	50	50 <sup>2</sup>	50 <sup>2</sup>
Non-Street Oriented Collector Streets (except Industrial Areas)	40	50	50	50
Non-Street Oriented Industrial Collector Streets	50	60	50 <sup>1</sup>	50
Street Oriented Arterial Streets (all land use contexts)	40	50	50 <sup>1</sup>	50
Non-Street Oriented Arterial Streets (all land use contexts)	50	70	70	60
Freeways/Expressways	80	120	90+	80+

### Notes:

1. Use 60 km/h Design Speed for horizontal alignment, vertical alignment, and sightlines for street oriented arterial streets.
2. Posted speed is subject to Council Approval and terms outlined in the Municipal Government Act, Traffic Safety Act and Speed Zones Bylaw 6894. Speeds should be reviewed in the future and reflect the outcome of Council decisions.

## APPENDIX F: LIST OF DESIGN TABLES

**Table 3.5** Design Domain for Design Speed of Pathways & Bikeways (in km/h)

Parameter: Design Speed	Design Domain Recommended Range		City of Edmonton Target Value
	Recommended Lower Limit	Recommended Upper Limit	
Where: + Uneven pathways + Low coefficient of friction + Protected bike lanes or pathways with multiple conflict points and insufficient sightlines + High usage by vulnerable users (e.g. schools, parks etc.) + Geometric constraints	10	20	20
Neighbourhood Route	20	30	20
District Connector Route	30	50	30

**Notes:**

1. Where the downgrade exceeds 5% for more than 60m, or strong tailwinds are likely due to prevailing wind conditions, design speed should be increased to  $\geq 40$  km/h.

## APPENDIX F: LIST OF DESIGN TABLES

**Table 3.6A** Design Domain for Lane Widths (in m): Design Speed 50 km/h or Less

Parameter: Lane Widths <sup>1,2</sup>	Design Domain Recommended Range		City of Edmonton Target Value
	Recommended Lower Limit	Recommended Upper Limit	
Standard Travel Curbside Lane (non-transit, non-truck route) <sup>3</sup>	3.25	3.75	3.25
Standard Travel Lane (non-transit, non-truck route)	3.00	3.50	3.00
Transit Route Curbside Lane	3.55	3.75	3.55
Transit Route Lane	3.30	3.50	3.30
Truck Route Curbside Lane	3.55	3.95	3.65
Truck Route Lane	3.30	3.70	3.40
Parking Lane	2.35	2.65	2.45 <sup>4</sup>

**Notes:**

1. Dimensions are for through and turning lanes. Turning lanes are typically at the lower end of the recommended ranges as these movements are completed at lower Operating Speeds.
2. Dimensions are measured to face of curb for curbside lanes.
3. For local streets, alleys, shared streets, and pedestrian only streets, a combined single drive lane with yield operation for both directions can be provided. This shared lane must be a minimum of 4.1 metres wide. For local streets, the minimum Travelled Way width shall be 8.0 m to accommodate required offsets for underground utilities and emergency response access, which may require parking restrictions. Service roads have a minimum Travelled Way width of 6.0 m due to the presence of an adjacent street. The designer must also consider the impacts of underground utilities, as well as winter design and operations when selecting Travelled Way widths.
4. Parking lanes for large trucks in industrial areas shall be 3.10 m to face of curb for collector and local roadways.

## APPENDIX F: LIST OF DESIGN TABLES

**Table 3.6B** Design Domain for Lane Widths (in m): Design Speed Over 50 km/h

Parameter: Lane Widths <sup>1,2</sup>	Design Domain Recommended Range		City of Edmonton Target Value
	Recommended Lower Limit	Recommended Upper Limit	
Standard Travel Curbside Lane (non-transit, non-truck route) <sup>3</sup>	3.55	3.95	3.75
Standard Travel Lane (non-transit, non-truck route)	3.30	3.70	3.50
Transit Route Curbside Lane	3.65	3.95	3.75
Transit Route Lane	3.40	3.70	3.50
Truck Route Curbside Lane	3.65	3.95	3.95
Truck Route Lane	3.40	3.70	3.70

**Notes:**

1. Dimensions are for through and turning lanes. Turning lanes are typically at the lower end of the recommended ranges as these movements are completed at lower Operating Speeds.
2. Dimensions are measured to face of curb for curbside lanes.

# APPENDIX F: LIST OF DESIGN TABLES

**Table 3.7** Framework for Consideration of Bikeway Facilities

Street Context				
Posted Speed	Max Motor Vehicle Volume (AADT)	Motor Vehicle Lanes	Key Operational Considerations	Bicycle Infrastructure Type
Any	Any	Any	Any of the following: - high curbside activity - frequent buses - motor vehicle congestion - turning conflicts	<b>Protected Bike Lane</b>
Up to 15 km/h	Less Relevant	No centerline, or single lane one-way	People walking share the travelled way	<b>Shared Street</b>
Up to 30 km/h	Up to 2000		Supports all ages and abilities when designed to ensure less than 50 motor vehicles per hour in peak direction (or up to 1000 vehicles per day)	<b>Local Street Bikeway</b>
Up to 40 km/h	Up to 1500			
Up to 50 km/h	1500 to 3000	Single lane each direction, or single lane one-way	Low curbside activity or low congestion pressure	<b>Painted or Buffered Bike Lane or Protected Bike Lane</b>
	3000 to 6000			<b>Buffered or Protected Bike Lane</b>
	Over 6000			<b>Protected Bike Lane</b>
	Any	Multiple lanes per direction		
Over 50 km/h	Up to 6000	Single lane each direction	Low curbside activity or low congestion pressure	<b>Protected Bike Lane or Reduce Roadway Speed</b>
		Multiple lanes per direction		<b>Protected Bike Lane or Reduce Roadway to Single Lane and Reduce Roadway Speed</b>
	Over 6000	Any	Any	<b>Protected Bike Lane (rigid barrier if 60 km/h or more) or Shared-Use Path</b>
High Speed (80 km/h or more) limited access roadways, natural corridors, utility corridors, or geographic edge conditions with limited conflicts		Any	High pedestrian volume (more than 33 per hour)	<b>Segregated shared pathway (i.e. with separate sidewalk and bike path) or Protected Bike Lane with rigid barrier</b>
			Low pedestrian volume	<b>Shared Pathway or Protected Bike Lane with rigid barrier</b>

## APPENDIX F: LIST OF DESIGN TABLES

**Table 3.8 Design Domain: Protected Bike Lanes (in m)**

Parameter	Design Domain Recommended Range		Target
	Lower Limit	Upper Limit	
<i>Bike Lane Component<sup>1</sup></i>			
<i>Unidirectional Bike Lane (District Connector)</i>	2.1	3.0	2.5
<i>Unidirectional Bike Lane (Neighbourhood Route)</i>	1.8	2.5	2.1
<i>Bidirectional Bike Lane (District Connector)</i>	3.0	4.5	4.0
<i>Bidirectional Bike Lane (Neighbourhood Route)</i>	2.5	3.0	3.0
<i>Buffer Component<sup>2,3</sup></i>			
<i>Buffer Width, Bike/Street</i>	0.6	N/A	1.5
<i>Buffer Width, Bike/Walk</i>	0.3	N/A	1.0

**Notes:**

1. The width of the bike lane component is measured to/from the face of the curb and accommodates the horizontal operating envelope, horizontal offset to curbs, 0.25 m gutters, and considerations for all seasons maintenance. For gutters wider than 0.25 m, additional width is required due to the longitudinal hazard caused by the joint between the gutter and pavement.
2. Where the roadway speed exceeds 60 km/h, a separated bike path or shared pathway is preferred. If a bike lane is used, a rigid barrier is required and/or the delineator width should be increased to ensure the lane is outside of the clear zone.
3. Wider buffers are preferred when practical within available right-of-way.

**Table 3.9 Design Domain: Painted Unidirectional Bike Lanes (in m)**

Parameter	Design Domain Recommended Range <sup>1</sup>		Target
	Lower Limit	Upper Limit	
<i>Bike Lane Component<sup>1</sup></i>			
<i>Unidirectional Bike Lane (District Connector)</i>	1.8	2.5	2.1
<i>Unidirectional Bike Lane (Neighbourhood Route)</i>	1.8	2.1	1.8
<i>Buffer Component<sup>2</sup></i>			
<i>Buffer Width, Bike/Street</i>	0.3	N/A	0.9

**Notes:**

1. The width of the bike lane component is measured from face of curb and accommodates the horizontal operating envelope, horizontal offset to curbs, 0.25 m gutters, and considerations for all seasons maintenance. For gutters wider than 0.25 m, additional width is required due to the longitudinal hazard caused by the joint between the gutter and pavement.
2. Wider buffers are preferred when practical within available right-of-way.

## APPENDIX F: LIST OF DESIGN TABLES

**Table 3.10 Design Domain: Shared-Use Paths and Bike Paths (in m)**

Parameter	Design Domain Recommended Range <sup>1</sup>		Target
	Lower Limit	Upper Limit	
<i>Bike Lane Component<sup>1</sup></i>			
<i>Unidirectional Bike Path (District Connector)</i>	2.1	3.0	2.5
<i>Unidirectional Bike Path (Neighbourhood Route)</i>	1.8	2.5	2.1
<i>Bidirectional Bike Path (District Connector)</i>	3.0	4.5	3.0
<i>Bidirectional Bike Path (Neighbourhood Route)</i>	2.5	3.0	3.0
<i>Shared Pathway</i>	3.0 <sup>2</sup>	6.0	3.0
<i>Buffer Component<sup>3</sup></i>			
<i>Minimum Width Buffer, Bike/Street</i>	0.6	N/A	1.5
<i>Minimum Width Buffer, Bike/Walk</i>	0.3	N/A	1.0

**Notes:**

- Widths measured from edge of path to edge of path. If paths are located adjacent to a curb (i.e., curblines or monolithic paths), an additional minimum 0.5 m width is required if the curbside activity is a travel lane (additional buffer for higher speed and/or volume streets) or 0.6 m for a parking lane.
- The Design Domain for shared pathway recommended lower limit along an Industrial Local Street can be 2.5 m if the path is not a primary corridor within the larger bicycle network at the discretion of the City.
- Wider buffers are preferred when practical within available right-of-way.

**Table 3.12 Design Domain: Median Widths (in metres)**

Parameter	Design Domain Recommended Range <sup>1</sup>	
	Recommended Lower Limit	Recommended Upper Limit
<i>Freeway Median, Depressed</i>	13.0	30.0
<i>Freeway Median, Raised</i>	5.5	N/A
<i>Non-Freeway, No Left Turn Bay<sup>1,2,3</sup></i>	1.2 <sup>3</sup>	N/A
<i>Non-Freeway, With Left Turn Bay</i>	4.5	N/A
<i>Non-Freeway, Walking/Cycling Refuge<sup>1,3</sup></i>	3.0	N/A

**Notes:**

- Non-freeway median widths are measured from face of curb to face of curb.
- Minimum median width of 1.8 m is required for a raised landscaped median.
- Walking/Wheeling/Cycling Refuge areas should have a minimum width of 3.0 m and area of 10 m<sup>2</sup> to provide sufficient room for all users. Refuge area medians with a median tip should be provided when a street crossing of more than 2 lanes per direction is required and the crosswalk/crossride passes through the median at street level.

# APPENDIX F: LIST OF DESIGN TABLES

**Table 3.13** Minimum Radii for Paved Bikeways  
(Source: TAC GDG Table 5.5.2)

Design Speed (km/h)	Coefficient of Lateral Friction	Minimum Radius for Design (m)	
		e = 0.02 m/m	e = 0.05 m/m
20	0.30	10	9
25	0.30	15	14
30	0.28	24	21
35	0.27	33	30
40	0.25	47	42
45	0.23	64	57
50	0.22	82	73

**Table 3.14** Design Domain: Gradients (in %)

Parameter: Gradient	Design Domain Recommended Range		Target Value <sup>3</sup>
	Lower Limit	Upper Limit	
Local & Collector	0.6%	8.0% <sup>1</sup>	6.0%
Arterial	0.6%	6.0% <sup>1</sup>	4.0%
Freeway/ Expressway	0.6%	5.0% <sup>2</sup>	4.0%

**Notes:**

1. Maximum grades of up to 12% may be utilized in exceptional circumstances where necessary due to Topography.
2. Higher maximum grades may be necessary in exceptional circumstances due to topography. Design consideration should be given to truck deceleration/ acceleration where grades in excess of 5.0% are used on high speed roads.
3. Maximum grades of 4.0% are recommended for Arterials and other major transportation facilities that are planned to include significant transit and/or goods movement wherever feasible.

**Table 3.15** Design Domain: Cycle and Walking Gradients (in %)

Parameter: Gradient	Design Domain Recommended Range	
	Recommended Lower Limit	Recommended Upper Limit
Dedicated Cycle Facility	0.6% <sup>1</sup>	6.0%
Walking and Wheeling Facility (SUP, sidewalk, walking trail)	0.6%	5.0% <sup>1</sup>

**Note:**

1. Minimum gradient may be reduced to 0.0% provided adequate cross slope and lateral slope is provided. Care should be given in designs where slopes are reduced.

**Table 3.16** Grade Impacts for People Cycling

Grade	Impacts
< 4%	<ul style="list-style-type: none"> <li>+ Ideal grade for cycling</li> <li>+ Uphill speed is 10 km/h</li> <li>+ Downhill coasting speeds can reach 25 km/h</li> </ul>
4% - 6%	<ul style="list-style-type: none"> <li>+ Downhill coasting speeds can reach 40 km/h</li> <li>+ Desirable to have a relatively flat area (3% or less) every 100 m to allow people cycling to rest for uphill</li> </ul>
6% - 8%	<ul style="list-style-type: none"> <li>+ Not recommended</li> <li>+ Considered steep</li> <li>+ Should be paved</li> <li>+ Will reduce uphill speeds</li> <li>+ Downhill coasting speeds can reach 60 km/h</li> <li>+ Higher design speeds should be used</li> <li>+ Warning signs should be posted in accordance with MUTCD-C Section A4.4.3</li> </ul>

**Table 3.17** Design Domain: Ancillary Zone (in m)

Parameter	Recommended Lower Limit	Recommended Upper Limit
Width*, Ancillary Zone	2.1	2.5

\* Measured from face of curb.

**Table 3.18** Design Domain: Furnishing Zone (in m)

Parameter	Recommended Lower Limit	Recommended Upper Limit
Width*, Furnishing Zone	1.7	5.0

\* Measured from face of curb.



## APPENDIX F: LIST OF DESIGN TABLES

**Table 3.19:** Design Domain: Pedestrian Trough Zone (in m)

Parameter: Width, Pedestrian Trough Zone		Recommended Lower Limit	Recommended Upper Limit
Local Street	Monowalk or separated sidewalk	1.8 <sup>1</sup>	N/A
Industrial Local Street	Monowalk	2.3	N/A
	Separated sidewalk	1.8	N/A
School Zone	Monowalk	2.5	N/A
Collector Street	Monowalk	2.3	N/A
	Separated sidewalk	1.8 <sup>1</sup>	N/A
Industrial Collector Street	Monowalk	2.3	N/A
	Separated sidewalk	1.8	N/A
Street Oriented Arterial Street <sup>3</sup>	Separated sidewalk <sup>2</sup>	2.5	N/A
Non-Street Oriented Arterial Street <sup>3</sup>	Separated sidewalk	1.8	N/A
Main Street/High Activity Area <sup>3</sup>	Separated sidewalk	3.0	N/A

**Notes:**

1. In constrained retrofit locations, the minimum width of the Pedestrian Trough Zone can be reduced to 1.5 m measured from face of curb to back of sidewalk for monowalk or edge to edge for separated sidewalks.
2. Monolithic sidewalks are not recommended along arterial streets. Where monolithic sidewalks cannot be avoided due to site constraints at the discretion of the City, the sidewalk width must be increased by a minimum of 0.5 metres.
3. The use of sidewalks along arterial streets will require alternate bicycle accommodation where shared pathway are currently being provided.

**Table 3.20** Design Domain: Frontage Zone (in m)

Parameter	Recommended Lower Limit	Recommended Upper Limit
Width, Frontage Zone	0.3 <sup>1</sup>	4.5

**Notes:**

1. Frontage zone may be reduced to 0.0 metres in Main Streets or where there is constrained right of way, at the discretion of the City.

## APPENDIX F: LIST OF DESIGN TABLES

**Table 3.21** Roadside Accommodation for People Walking, Wheeling, and Cycling on Streets in Cross Sections (i.e., Non-Urban Areas)

Speed Limit	Walking/Wheeling & Cycling Facilities
≥40 km/h	shared pathways off the Travelled Way
<40 km/h	Sidewalks off the Travelled Way or on-street bicycle facilities

**Table 3.22** Sidewalk/Walkway/shared pathway/Trail Grading Requirements

Maximum Slope	Maximum Length	Maximum Height	Landings
≤2%	None	None	Not required
>2% to ≤5%	None	None	Note 1
>5% to ≤6.25%	12 m	750 mm	Every 12 m
>6.25% to ≤8.30%	9 m	750 mm	Every 9 m
>8.30% to ≤10%	1.5 m	150 mm	Note 2

**Notes:**

1. Landings at 750 mm elevation difference are desirable.
2. It is recognized that the gradient and building layout on some streets may make the provision of landings impractical.

**Table 3.23** Stopping Sight Distance for Passenger Cars

Design Speed (km/h)	Stopping Sight Distance by Grade (m)						
	-9%	-6%	-3%	0	3%	6%	9%
20	20	20	20	20	19	18	18
30	35	35	32	35	31	30	29
40	53	50	50	50	45	44	43
50	74	70	66	65	61	59	58
60	97	92	87	85	80	77	75
70	124	116	110	105	100	97	93
80	154	144	136	130	123	118	114

(Adapted from TAC GDG Tables 2.5.2 and 2.5.3, for brake reaction time of 2.5 s, deceleration rate of 3.4 m/s<sup>2</sup>, and a passenger car. NOTE: SSD for trucks are longer than those provided below and should be calculated based on guidance from TAC GDG Section 2.5.3.)

## APPENDIX F: LIST OF DESIGN TABLES

**Table 3.24** Minimum Sightline Distance for Approach Clear Sight Triangle

Design Speed (km/h)	Minimum Sightline Distance, b (m)
<30	Approach sight triangles do not apply in these cases. For locations where speeds are less than 20 km/h (e.g., alleys), people driving are to exercise reasonable judgement and proceed only when safe to do so, yielding the right of way to motor vehicle, cycling, and walking/wheeling traffic.
30	70
40	90
50	115
60	135
70	160
80	180

(Adapted from TAC GDG Table 9.9.10, for intersection approach grades ≤ 3% based on passenger car making a left or right turn at a yield controlled intersection)

**Table 3.25** Minimum Sightline Distance for Approach Clear Sight Triangle

Design Speed (km/h)	Minimum Sightline Distance, b (m)
30	65
40	85
50	105
60	130
70	150
80	170

(Adapted from TAC GDG Table 9.9.4, for intersection approach grades ≤ 3% and based on passenger car)

# APPENDIX F: LIST OF DESIGN TABLES

**Table 3.26** Design Domain: Intersection Corner Radii (in m)

Parameter: Intersection Corner Radii (Departing Street/Receiving Street)	Design Vehicle	Control Vehicle	Design Domain Recommended Range <sup>1</sup>		Design Target Value <sup>2</sup>
			Recommended Lower Limit	Recommended Upper Limit	
Arterial Truck Route/Arterial Truck Route <sup>3</sup>	WB-21	WB-36	Use High Entry Angle channelized right turn design		
Arterial Truck Route/Arterial Non-Truck Route <sup>3,5</sup>	B-12	WB-21	7.5	15.0	8.0
Arterial Truck Route/Collector	B-12	WT, FT	10.0	15.0	10.0
Arterial Non-Truck Route/Arterial Truck Route <sup>3,5</sup>	B-12	WB-21	7.5	15.0	8.0
Arterial Non-Truck Route/Arterial Non-Truck Route <sup>3,5</sup>	B-12	WB-21	7.5	15.0	8.0
Arterial Non-Truck Route/Collector	B-12	WT, FT	10.0	15.0	10.0
Collector/Arterial Truck Route <sup>3</sup>	B-12	WT, FT	7.5	10.0	8.0
Collector/Arterial Non-Truck Route <sup>3</sup>	B-12	WT, FT	6.5	10.0	7.0
Collector/Collector	B-12	WT, FT	7.5	10.0	8.0
Main Street/Any Street, <sup>6,7,8</sup> OR Any Street/Main Street	MSU	B-12	4.5	10.0	6.0
Local/Any Street OR Any Street/Local	P	WT, FT, MSU	4.0	6.0	4.0

**Notes:**

- Designers should use corner radii toward the lower end of the Design Domain if the design target value is not used, however, turning maneuvers must be confirmed using swept path analysis for the Design and Control Vehicle
- Target value is based on typical street cross sections as shown in the Standard Details. Swept path analysis is required to confirm corner radius based on the Design Principles. Where a corner is utilized by a bus, and the total width of the receiving lanes is less than 6.0 m, a two centred R9 + R70 curve shall be used.
- All arterial street receiving lane scenarios based on two receiving lanes along the arterial street and a median. If more than two lanes are provided, a corner radius lower than the Design Domain recommended lower limit is possible, but must be confirmed using swept path analysis.
- When along a Main Street or inside the Mature Neighbourhood Overlay, review simple or multi-centred radius curves with the objective to minimize crossing distances for people walking.
- Where there is a raised or depressed centre median, a simple radius may not accommodate the Control Vehicle. Complete swept path analysis to confirm vehicle turning movements. The use of a High Entry Angle channelized right turn may be required.
- See City’s MSG for more information on corner radii guidance for Main Streets. Use of higher radii on Main Streets should be rationalized and documented via a design exception.
- A B-12 design vehicle should be utilized where bus movements are expected and may require adjustment to curb radii depending on number of receiving lanes.
- Where the receiving street has a single 3.0m lane and encroachment into oncoming lanes is not desirable for the MSU design vehicle, a R7.5 + R50 two-centred curve may be used.

## APPENDIX F: LIST OF DESIGN TABLES

**Table 3.27** Design Domain: Intersection Corner Radii – Industrial Areas (in m)

Parameter: Intersection Corner Radii (Departing Street/Receiving Street) <sup>1</sup>	Design Vehicle	Control Vehicle	Design Domain Recommended Range <sup>2</sup>		Design Target Value <sup>3</sup>
			Recommended Lower Limit	Recommended Upper Limit	
Arterial Truck Route/Industrial Area Collector	WB-21	WB-36	Use High Entry Angle channelized right turn design		
Arterial Truck Route/Industrial Area Local	WB-21	WB-36	Use High Entry Angle channelized right turn design		
Industrial Area Collector/Arterial Truck Route <sup>4</sup>	WB-21	WB-36	Use High Entry Angle channelized right turn design		
Industrial Area Collector/Industrial Area Collector	WB-21	WB-36	11.5	15.0	12.0
Industrial Area Collector/Industrial Area Local	WB-21	WB-36	14.0	15.0	15.0
Industrial Area Local/Arterial Truck Route <sup>4</sup>	WB-21	WB-36	Use High Entry Angle channelized right turn design		
Industrial Area Local/Industrial Area Collector	WB-21	WB-36	12.5	15.0	13.0
Industrial Area Local/Industrial Area Local	WB-21	WB-36	15.0	15.0	15.0

**Notes:**

1. Arterial street/arterial street intersection Design Domain is provided in **Table 3.26**.
2. Designers should use corner radii toward the lower end of the Design Domain if the design target value is not used, however, turning maneuvers must be confirmed using swept path analysis for the Design and Control Vehicle.
3. Target value is based on typical street cross sections as shown in the Standard Details. Swept path analysis is required to confirm corner radius based on the Design Principles.
4. All arterial street receiving lane scenarios based on two receiving lanes along the arterial street and a median. If more than two lanes are provided, a corner radius lower than the Design Domain recommended lower limit is possible, but must be confirmed using swept path analysis.

## APPENDIX F: LIST OF DESIGN TABLES

**Table 3.28** Curb Ramp Design Requirements<sup>1</sup>

Design Criteria		Design Requirement
Approach/ Sidewalk	Cross Grade	≤ 2%
	Longitudinal Grade	≤ 5%
Curb ramp	Provision	At every corner and mid-block crossing
	Grade	≤ 6.0%
	Curb Ramp Flare	400 mm (separated sidewalk)/1700 mm (monowalk)
	Width (exclusive of fared sides)	1.8 m min.; should match sidewalk width
	Length	Based on grade
	Tactile Device	<p><b>Tool Grooved Concrete</b> Tool Grooved Concrete at minimum at each curb ramp along or crossings all freeway/expressway, arterial, and collector, and local streets and off-street shared pathways (e.g., paths along utility corridors) crossings with these street classifications.</p> <p><b>Truncated Domes</b> Truncated domes shall be utilized at locations with high pedestrian volumes, including main streets, pedestrian priority areas, and street oriented developments, as well as at schools, transit centres, libraries, and recreation centres.</p> <p>If using truncate domes with midblock crossings, guidance should also be provided to direct users to the crossing, a physical element perpendicular should also be considered.</p> <p>Example details 5520, 5521, 5522, 5523, 5524, 5530 and 5531 provide guidance around the use of truncated domes for curb ramps. 5530 and 5531 provide pilot examples of directionality using truncated domes and detectable guidance surface indicators.</p>
Landing	Width	Match curb ramp
	Length	1.8 m min. and up to 2.25 m to accommodate most wheelchair types

## APPENDIX F: LIST OF DESIGN TABLES

**Table 3.29** Design Domain: Raised Crosswalks and Intersections - Ramp Length and Grade Break

Parameter: Design Speed (km/h)	Design Domain Recommended Range <sup>1</sup>		
	Lower Limit	Upper Limit	Target <sup>2</sup>
Ramp Length	1.75	2.75	1.75
Grade Break	4.0%	7.5%	6.25%

**Note:**

1. On frequent transit routes or where high volumes of truck traffic are present, a 5.75% grade break is recommended with a maximum grade break of 6.25%.
2. Target design speed is 40 km/h. If a higher design speed is selected, increasing the ramp length and/or reducing the grade break is required.

**Table 3.30** Design Domain: Continuous Crossings - Ramp Length and Grade Break

Parameter: Design Speed (km/h)	Design Domain Recommended Range		
	Lower Limit	Upper Limit	Target <sup>1</sup>
Ramp Length	0.8	1.0	0.8
Grade Break	10%	16.5%	12.5%

**Note:**

1. Target design speed is 5 km/h, which is consistent with a stop or yield control. If a higher design speed is selected, increasing the ramp length and/or reducing the grade break is required.

**Table 3.31** Roundabout Category Comparison

Design Element	Mini-Roundabout	Single-Lane Roundabout	Multilane Roundabout
Desirable maximum entry design speed	25 to 30 km/h	30 to 40 km/h	40 to 50 km/h
Maximum number of entering lanes per approach	1	1	2+
Typical inscribed circle diameter	13 to 27 m	27 to 55 m	46 to 91 m
Central island treatment	Fully traversable	Raised (may have a traversable apron)	Raised (may have a traversable apron)
Typical daily service volumes on 4-leg roundabout below which may be expected to operate without requiring a detailed capacity analysis (veh/day)*	Up to approximately 15,000 vpd	Up to approximately 25,000 vpd	Up to approximately 45,000 vpd for two-lane roundabout

\*Operational analysis needed to verify upper limit for specific applications or for roundabouts with more than two lanes or four legs. (Table Source: NCHRP RPT 672)

## APPENDIX F: LIST OF DESIGN TABLES

Note: For any projects signed after July 2020, the Volume 1: Table of Offsets has precedence over any offsets also shown in Table 3.32. The volume 1 Table of Offsets is available at: City of Edmonton Design and Construction Standards

**Table 3.32** Design Domain: Offsets for Utilities, Poles, Cabinets, Trees, Sidewalk/shared pathway, and Face of Curb (in m)

Parameter: Offsets for Utilities, Poles, Cabinets, Trees, Sidewalk/shared pathway, and Face of Curb	Design Domain	
	Minimum	Target
<i>Offsets to Face of Curb</i>		
<i>Streetlight Pole (centre of pole) to Face of Curb</i>	0.5 m when adjacent to Ancillary Zone or Painted or Protected Bike Lane; 1.2 m to Travelled Way; To be in line with Trees or closer to Face of Curb	1.25 m along Local Streets; 1.25 m along Collectors; 2.0 m along Arterials; 2.6 m for monowalks along Local and Collector Streets 3.0 m for monowalks adjacent to School Sites
<i>Tree (centre of tree) to Face of Curb</i>	Trees to be placed in line with or further from Face of Curb than Streetlight Poles; See also the City's Design and Construction Standards Volume 5	
<i>Transformer (centre of transformer) to Face of Curb (Local Streets)</i>	2.0 m	
<i>Deep Utilities (centreline) to Face of Curb</i>	1.5 m	
<i>Offsets to Active Transportation</i>		
<i>Streetlight Pole (centre of pole) to Sidewalk/Shared-Use Path (edge of sidewalk or path)</i>	0.5 m	1.0 m
<i>Streetlight Pole (centre of pole) to Walkway (edge of walkway)</i>	0.5 m	1.5 m
<i>Hydrant (centre of hydrant) to Edge of Ancillary Zone active uses (e.g., patio, boardwalk, bike corral)</i>	1.5 m	
<i>Multi-party Trench (centreline) (e.g., main power, streetlight feeds, phone, telecoms) to Face of Curb</i>	2.5 m	
<i>Location of all surface appurtenances associated with underground utilities (including, but not limited to, transformers, cubicles, catch basins, manholes and utility covers, water valves, power/telecom vaults) with respect to Active Transportation Infrastructure</i>	Located outside of any sidewalks, shared pathways, walkways, crosswalks, and curb ramps; See also the City's Design and Construction Standards Volumes 3, 4, and 7	



## APPENDIX F: LIST OF DESIGN TABLES

Note: For any projects signed after July 2020, the Volume 1: Table of Offsets has precedence over any offsets also shown in Table 3.33. The volume 1 Table of Offsets is available at: City of Edmonton Design and Construction Standards

**Table 3.33** Design Domain: Offsets for Utilities, Poles, Cabinets, Trees, Sidewalk/shared pathway, and Face of Curb (in m)

Parameter: Offsets for Utilities, Poles, Cabinets, Trees, Sidewalk/shared pathway, and Face of Curb	Design Domain	
	Minimum	Target
<i>Offsets to Intersections</i>		
<i>Catch Basin to Intersection</i>	Locate at End of Curve OR Beginning of Curve and not within the curb ramp and crosswalk; See also the City's Design and Construction Standards Volume 3	
<i>Poles (centre of pole) to Intersection</i>	0.9 m	
<i>Trees (centre of tree) to Intersection</i>	15 m	
<i>Transformer/Cubicle Cabinet (centre or transformer/cabinet) to Intersection (edge of pavement)</i>	15 m	
<i>Traffic Control Cabinet (centre of cabinet) to Intersection (edge of pavement)</i>	Locate outside the Clear Sight Triangles to allow for required sightlines	
<i>Offsets to Accesses &amp; Driveways</i>		
<i>Streetlight Pole (centre of pole) to Residential Driveway (edge of driveway)</i>	1.0 m	
<i>Streetlight Pole (centre of pole) to Commercial/Industrial Access (edge of access)</i>	1.5 m	
<i>Transformer/Cubicle/Traffic Control Cabinet (centre of cabinet) to Commercial/Industrial Access (edge of pavement)</i>	10 m	

## APPENDIX F: LIST OF DESIGN TABLES

Note: For any projects signed after July 2020, the Volume 1: Table of Offsets has precedence over any offsets also shown in Table 3.34. The volume 1 Table of Offsets is available at: City of Edmonton Design and Construction Standards

**Table 3.34** *References for Other Offsets for Utilities, Poles, Cabinets, Trees, Sidewalk/shared pathway, and Face of Curb*

<i>Parameter: Offsets for Utilities, Poles, Cabinets, Trees, Sidewalk/shared pathway</i>	<i>D&amp;C Volume Source(s)</i>	<i>Parameter: Offsets for Utilities, Poles, Cabinets, Trees, Sidewalk/shared pathway</i>	<i>D&amp;C Volume Source(s)</i>
<i>Transformer / Switching Cubicle to Bus Stop Pad</i>	Volume 7	<i>Hydrant to Transit Stop</i>	Volume 4
<i>Pad-Mounted Equipment to Edge of Walkway Property Line</i>	Volume 7	<i>Hydrant to Driveway</i>	Volume 4
<i>Pad-Mounted Equipment to Transportation Signs</i>	Volume 7	<i>Manhole to Face of Curb</i>	Volume 3 & 4
<i>Power Crossings to Bus Stop Pad</i>	Volume 7	<i>Manhole or Utility Cover to Sidewalk/Shared-Use Path</i>	Volume 3 & 4
<i>Transformers to Residential Driveways</i>	Volume 7	<i>Catch Basin to Edge of Sidewalk or Path</i>	Volume 3
<i>Tree to Edge of Commercial or Industrial Accesses</i>	Volume 5	<i>Catch Basin to Intersection</i>	Volume 3
<i>Tree to Edge of Residential Driveways</i>	Volume 5	<i>For additional offsets related to Drainage Infrastructure</i>	Volume 3
<i>Tree to Transit Zone</i>	Volume 5	<i>For additional offsets related to Water Infrastructure</i>	Volume 4
<i>Tree to Streetlight Pole</i>	Volume 5	<i>For additional offsets related to Landscaping Infrastructure</i>	Volume 5
<i>Tree to Traffic Control Sign</i>	Volume 5	<i>For additional offsets related to Auxiliary and Secondary Power Infrastructure</i>	Volume 6
<i>Tree to Sidewalk/shared pathway</i>	Volume 5	<i>For additional offsets related to Power Infrastructure</i>	Volume 7
<i>Hydrant to Face of Curb</i>	Volume 4		

## APPENDIX F: LIST OF DESIGN TABLES

**Table 3.35** Traffic Calming Measures – Potential Benefits (Adapted from 1998 TAC CGNTC Table 3.2)

Measure		Potential Benefits			
		Speed Reduction	Speed Reduction	Conflict Reduction	Environment
Vertical Deflection	Raised Crosswalk <sup>1</sup>	■	□	▲	▲
	Raised Intersection <sup>1</sup>	▲	□	▲	▲
	Sidewalk Extension	▲	□	■	□
	Speed Hump	■	▲	■	▲
	Textured Crosswalk	□	□	▲	▲
	Speed Cushion	■	▲	■	▲
	Speed Table	■	▲	■	▲
Horizontal Deflection/ Narrowing	Chicane - one lane	■	■	■	▲
	Chicane - two lane	▲	□	▲	▲
	Curb Extension	▲	□	□	■
	Curb Radius Reduction	▲	□	□	▲
	On-street Parking	▲	□	□	▲
	Raised Median Island	▲	□	▲	□
	Traffic Circle, Button, Mini-Roundabout	■	▲	■	■
	Lateral Shift	▲	□	▲	▲
	Speed Kidney	▲	□	□	■
	Lane Narrowing	▲	□	□	■
	Road 'Right-sizing'	▲	□	□	■
Obstruction	Directional Closure	□	■	▲	▲
	Diverter	□	■	▲	▲
	Full Closure	□	■	■	▲
	Intersection Channelization	□	▲	▲	▲
	Raised Median Through Intersection	□	■	▲	▲
	Right-In/Right-Out Island	□	■	▲	▲

Substantial benefits    
  Minor benefits    
  No benefit  
 Minor Measure not in 1998 TAC CGNTC (benefits yet to be verified)

<sup>1</sup> For information on raised crossings refer to section 3.6.4.3

# APPENDIX F: LIST OF DESIGN TABLES

**Table 3.36** Traffic Calming Measures – Potential Disbenefits (Adapted from 1998 TAC CGNTC Table 3.3)

Measure		Potential Disbenefits					Cost
		Local Access	Emergency Response	Other Travel Modes	Enforcement	Maintenance	
Vertical Deflection	Raised Crosswalk <sup>1</sup>	□	▲	▲	□	▲	\$ to \$\$
	Raised Intersection <sup>1</sup>	□	▲	▲	□	▲	\$\$\$
	Sidewalk Extension	□	□	□	□	▲	\$\$
	Speed Hump	□	▲	▲	□	▲	\$ to \$\$
	Textured Crosswalk	□	□	▲	□	▲	\$ to \$\$
	Speed Cushion	□	▲	▲	□	▲	\$ to \$\$
	Speed Table	□	▲	▲	□	▲	\$ to \$\$
Horizontal Deflection/ Narrowing	Chicane - one lane	□	▲	▲	□	▲	\$\$ to \$\$\$
	Chicane - two lane	□	□	□	□	▲	\$\$
	Curb Extension	□	□	▲	□	▲	\$ to \$\$
	Curb Radius Reduction	□	□	□	□	▲	\$ to \$\$
	On-street Parking	□	▲	▲	□	▲	\$ to \$\$
	Raised Median Island	▲	□	□	□	▲	\$ to \$\$
	Traffic Circle, Button, Mini-Roundabout	□	▲	▲	□	▲	\$\$ to \$\$\$
	Lateral Shift	□	▲	▲	□	□	\$ to \$\$
	Speed Kidney	□	▲	▲	□	▲	\$ to \$\$
	Lane Narrowing	□	▲	▲	□	□	\$
	Road 'Right-sizing'	□	▲	■	□	□	\$ to \$\$
Obstruction	Directional Closure	▲	□	▲	▲	▲	\$\$
	Diverter	▲	▲	▲	□	▲	\$\$ to \$\$\$
	Full Closure	■	■	▲	□	▲	\$\$ to \$\$\$
	Intersection Channelization	▲	▲	□	□	▲	\$\$ to \$\$\$
	Raised Median Through Intersection	▲	▲	▲	□	▲	\$ to \$\$
	Right-In/Right-Out Island	▲	▲	▲	▲	▲	\$\$

\$ Low Cost      \$\$ Moderate Cost      \$\$\$ High Cost  
 ■ Substantial benefits      ▲ Minor benefits      □ No benefit  
 ■ Minor Measure not in 1998 TAC CGNTC (benefits yet to be verified)

<sup>1</sup> For information on raised crossings refer to section 3.6.4.3



# COMPLETE STREETS CONSTRUCTION SPECIFICATIONS

*City of Edmonton*



<b>1. GENERAL</b>	<b>232</b>
1.1 CONSTRUCTION SPECIFICATIONS CONTENT	232
1.2 PAVEMENT DESIGN REQUIREMENTS	232
<b>2. SITE PREPARATION</b>	<b>236</b>
2.1 AGGREGATES	236
2.2 CLEARING AND GRUBBING	241
2.3 GRADING	243
2.4 PAVEMENT AND CONCRETE REMOVAL	247
<b>3. UTILITIES</b>	<b>249</b>
3.1 TRENCH BACKFILL	249
3.2 UTILITY CUT RESTORATION	259
<b>4. BASE PREPARATION</b>	<b>264</b>
4.1 SUBGRADE PREPARATION	264
4.2 CEMENT STABILIZED SUBGRADE	267
4.3 PROOF ROLLING	271
4.4 PLANT MIX SOIL CEMENT	273
4.5 GEOTEXTILE	280
<b>5. GRANULAR MATERIAL</b>	<b>283</b>
5.1 GRANULAR BASE COURSE	283
5.2 GRANULAR WALKWAY	287
5.3 FULL DEPTH RECLAIMED BASE COURSE	289
<b>6. PAVEMENTS</b>	<b>293</b>
6.1 SGC HOT-MIX ASPHALT CONCRETE	293
6.2 STONE MASTIC ASPHALT CONCRETE	310
6.3 SGC HOT-MIX ASPHALT PAVING	320
6.4 STONE MASTIC ASPHALT PAVING	337
6.5 PAVING BRICK ON SAND BED	350
6.6 PAVEMENT COLD MILLING	353

6.7	<i>LIQUID ASPHALT COATS</i>	356
6.8	<i>FULL DEPTH RECLAMATION USING FOAMED ASPHALT</i>	360
6.9	<i>PAVEMENT CRACK SEALING</i>	376
6.10	<i>BRIDGE DECK ASPHALT SURFACING</i>	381
6.11	<i>RECYCLED ASPHALT PAVING</i>	394
<b>7.</b>	<b>CONCRETE</b>	<b>400</b>
7.1	<i>CEMENT CONCRETE</i>	400
7.2	<i>CONCRETE SIDEWALK, CURB AND GUTTER, AND SLABS</i>	408
7.3	<i>CONCRETE FOR ROADWAYS</i>	415
7.4	<i>CONCRETE BASE</i>	426
7.5	<i>CONCRETE PAVEMENT</i>	430
7.6	<i>CONCRETE PAVING UNITS</i>	434
7.7	<i>ROLLER COMPACTED CONCRETE</i>	437
7.8	<i>PATTERNED CONCRETE SLAB</i>	448
7.9	<i>ULTRATHIN WHITETOPPING</i>	451
7.10	<i>CONCRETE FORMS AND ACCESSORIES</i>	460
7.11	<i>FILLCRETE</i>	464
7.12	<i>REINFORCING STEEL</i>	468
7.13	<i>SLABJACKING</i>	471
<b>8.</b>	<b>MISCELLANEOUS</b>	<b>474</b>
8.1	<i>GABIONS</i>	474
8.2	<i>HEAVY ROCK RIP RAP</i>	478
8.3	<i>BOX BEAM GUARD RAIL</i>	483
8.4	<i>CONCRETE BARRIER</i>	485

## 1. GENERAL

### 1.1 CONSTRUCTION SPECIFICATIONS CONTENT

The objective of the Roadway Construction Specifications is to outline the materials testing requirements for roadway construction. All construction of roadway municipal improvements shall be in compliance with the Roadways Construction Specifications. The City of Edmonton is the interpreter of the acceptability of the work covered by the Contract Documents or Servicing Agreement. Should the City determine that the work does not comply with the specification, the City has the right to refuse acceptance until all defects have been rectified.

The following documents should be referenced in order to understand all the requirements for Construction Completion Certificate and Final Acceptance Certificate approval:

- Volume 1: General
- Servicing Agreement for Private Developer Projects
- Contract Documents for City of Edmonton Projects
- Other Documents referenced throughout the Construction Specifications
- Current version of the City of Edmonton Development Engineering Inspector Guideline for Private Developer Projects – Available through the Subdivision and Development Coordination Section of the Urban Form and Corporate Strategic Development department.

### 1.2 PAVEMENT DESIGN REQUIREMENTS

It is the objective of this section to ensure a degree of consistency in Designs provided by Engineering Consultants by following specific structural design methodologies within a general framework. At the same time the design process provides sufficient flexibility to allow for the judgment and innovation by experienced pavement design engineers to address the specific conditions of each project.

The City of Edmonton will continue to be the custodian of all pavement evaluation, management and inventory data. These data will be available for use by engineering consultants. The City of Edmonton's role in the design process will be to review pavement designs provided by consultants for completeness, conformance to the design philosophies and methodologies outlined below and to ensure that the design is supported by appropriate Engineering investigation and evaluation.

The methodologies detailed apply to the design of flexible (granular Base course) pavement structures on all classes of roadway (local, collector, and arterial) in the City of Edmonton. This section reflects the most appropriate design methodologies, adapted for Edmonton conditions and experience that are available at the present time. Changes in technology related to non-destructive pavement evaluation testing, laboratory testing and analysis, mechanistic pavement design and



new paving materials; new maintenance practices; and changing traffic conditions and loadings will all influence the future performance of pavements and will result in necessary changes to this section in the future.

This section is not all encompassing in terms of addressing all factors that may influence the design and performance of a pavement. Pavement designers will need to address these factors on a project by project basis and, where necessary, will have to carry out additional research to ensure appropriate and cost-effective design solutions are provided.

It is important that the design engineer have ready access to background publications and the research of others (eg. Asphalt Institute [AI], American Association of State Highway and Transportation Officials [AASHTO], Federal Highway Administration [FHWA], Transportation Research Board [TRB], Transportation Association of Canada [TAC], Association of Asphalt Paving Technologists [AAPT], Canadian Technical Asphalt Association [CTAA], etc.) that form the technical background to the design and performance of flexible pavement structures.

It is intended that this section be utilized in conjunction with the AASHTO Guide for the Design of Pavement Structures [AASHTO 93]. Design submissions must meet the minimum requirements identified in the AASHTO Guide. For New Construction or Reconstruction, see AASHTO Guide for the Design of Pavement Structures - Part II, for Rehabilitation see AASHTO Guide for the Design of Pavement Structures - Part III. Recommendations submitted without the submission of appropriate design details will be rejected.

The following Tables indicate the range of inputs for use in the AASHTO 93 Design guide for City of Edmonton Projects:

**Table 1.2.1: Recommended Subgrade Modulus**

Soil Type ( As determined through Investigation)	Subgrade Modulus $M_R$ (MPa)
High Plastic Clay (Ci, CH)	30
Low Plastic Clay (CL, MH)	40

**Table 1.2.2: Recommended Reliability**

Design ESALS ( $\times 10^6$ )	Reliability %
<0.1	75
0.1-5.0	85
5.0 to 10.0	90
>10.0	95

**Table 1.2.3: Recommended Layer Coefficients**

Material	Layer Coefficient
Asphalt Concrete (Surface and Base Course)	0.40
Asphalt Stabilized Base Course (Foamed Asphalt)	0.28
Granular Base Course	0.14
Granular Subbase Course	0.10

**Table 1.2.4: Recommended Drainage Coefficient**

Drainage Coefficient ( Granular Base)	1.0
---------------------------------------	-----

**Table 1.2.5: Recommended ESAL Values for Road Classifications**

Roadway Design	Minimum Design ESAL Value*
Residential Local Roadway	3.6 x 10 <sup>4</sup>
Residential Minor Collector (Truck Route with No Bus)	1.8 x 10 <sup>5</sup>
Residential Major Collector (Truck and Bus Route)	3.6 x 10 <sup>5</sup>
Light Industrial & Commercial	3.6 x 10 <sup>6</sup>
Arterial	Requires Traffic Evaluation
Major Arterial	Requires Traffic Evaluation

\*Note: ESAL values should always be verified before design.

**Table 1.2.6: Recommended Serviceability**

Serviceability Index	
Initial	4.2
Terminal	2.5

**Table 1.2.7: Recommended Standard Deviation**

Pavement Type	Overall Standard Deviation
Asphalt	0.45 (new Construction) 0.49 (Overlays)
Concrete	0.35 (new Construction) 0.39 (Overlays)

## 2. SITE PREPARATION

### 2.1 AGGREGATES

#### 2.1.1 General

##### 2.1.1.1 Content

This section includes designated classes, gradation and physical requirements of aggregate, production and supply of aggregate, and quality assurance.

##### 2.1.1.2 Quality Assurance

The quality assurance laboratory will conduct sieve analyses to ASTM C136 and other tests to ensure that aggregate being produced and supplied meets the requirements of Tables 2.1.1, 2.1.2, and 2.1.3. The Contractor shall provide a daily estimate of production tonnage to the quality assurance laboratory.

A minimum of one sieve analysis per 500 tonnes of aggregate supplied to a jobsite is required. The aggregate may be sampled from a stockpile at the jobsite or at the gravel pit / crusher site.

If the aggregate fails to meet the specified gradation, the contractor shall suspend gravel placement until proof of compliance with the specification is provided to the Engineer. Alternatively, the contractor may elect to remove the suspect gravel from the jobsite and provide aggregate from a different source.

##### 2.1.1.3 Submittals

- Provide copies of scale certificates to the Engineer prior to use.
- Each truckload of aggregate weighed in shall have a ticket filled out and submitted to the Engineer.
- **Quality Control Plan**
  - Submit a minimum of one sieve analysis per 500 tonnes of aggregate for stockpile or 300 tonnes of aggregate shipped directly from the crusher to the jobsite to the **Technical Services Section, Integrated Infrastructure Services**. Do not stockpile or ship aggregate to the jobsite until the City has accepted the applicable test results. Make the test results available weekly to the City for review **including individual test results as well as the average grading as described below.**
  - **Evaluation of Tests:** The average grading of the first 8 consecutive sieve tests shall conform to the specified grading band. If it does not, adjust the production process so that the average grading of material already produced and that produced in the next

8 consecutive tests will conform to specifications. Failing this, do not supply aggregate represented by the nonconforming average of 16 tests.

- The preceding evaluation will be repeated for subsequent series of 8 consecutive tests.

#### **2.1.1.4 Storage and Protection**

Place aggregate in horizontal lifts of 750 mm maximum thickness. Avoid segregation of particle sizes. Do not dump aggregate over the edges or down the faces of the stockpile. On completion, peak the stockpile at a minimum 3% grade.

### **2.1.2 Products**

#### **2.1.2.1 Materials**

- Aggregates shall conform to the requirements in Tables 2.1.1, 2.1.2 and 2.1.3

**Table 2.1.1: Aggregate Gradation Specifications for Designations 1-3**

Designation	1				2	3				
	10	10	20	16.0*	20	20	25	40	63	80
Application	10mm-HT	10mm-LT	20mm-B	SMA	Soil Cement	Granular Base	Granular Base	Granular Base	Granular Sub-Base	Granular Sub-Base
80 000										100
63 000								100	100	
25 000			100				100	70 -94	55 -75	46 -85
20 000			97 - 100	100	100	100	82-97	60 -90	50 -70	40 -81
16 000			83 - 97	97-100	-	84 -95	70-93	55 -85	44 -65	32 -76
12 500	100	100	70 - 92	88-100	60 -96	60-90	60-86	50 -80	38 -60	30 -70
10 000	97-100	97-100	61 - 84	30 -80	-	50-84	52-79	44 -74	-	-
8 000	70-94	80-94	52 - 77	-						
6 300	45-85	65-85	44 - 70	22-45	-	-	-	-	23 -47	-
5 000	32-75	50-75	38 - 65	20-35	36 -75	37- 62	35-64	32 -62	20 -45	25 -50
2 500	23-55	35-55	26 - 52	16-26		-	-	-	-	-
2 000	-	-	-	-	24 -54	26- 50	24-50	20 -50	14 -38	19 -42
1 250	16-45	25-45	18 - 41	14-22	20-43	19- 43	19-43	17 -43	12 -34	15 -38
630	11-36	20-36	13 - 31	13-20	14-34	14- 34	14-34	12 -34	10 -28	10 -32
400	-	-	-	-	11 -29	11- 28	10-27	10 -28	8 -24	7 -27
315	8-26	14-26	9 - 22	12-18	9 -26	10- 25	9-24	8 -25	7 -22	6 -24
160	5-15	7-15	6 - 14	10-16	6 -20	6 -18	6-18	5 -18	4 -17	3 -18
80	3-8	4-8	3 - 7	10 -14	2 -10	2-10	2-10	0 -10	0 -10	0 -10

\*Note: SMA Combined Aggregate gradation includes the required mineral filler

**Table 2.1.2: Aggregate Gradation Specifications for Designations 4 - 7**

Designation	4		5		6		7	
	2.5	10	5	80	20	25	10	80
Application	Unit Pavers Joint Sand	Unit Pavers Bedding	Grout Sand	Culvert Bedding	Sub-Drain Rock	Sewer Rock	Sewer Backfill	Culvert Backfill
80 000				100				100
25 000						100		
20 000				85 - 100	100			
14 000					90 - 100			
10 000		100			45 - 75		100	
5000		75 - 95	100	70 - 90	0 - 15	10 max	70 - 100	30 - 60
2500	100	35 - 70			0 - 5			
1250	85 - 100	20 - 50						
800				40 - 80				
630	50 - 90	10 - 40						
315	25 - 60	5 - 20	50 - 95					
160	12 - 30	2 - 8					5 - 20	
80	10 - 15	0 - 5	25 max	0 - 15		2 max	0 - 12	0 - 15

Table 2.1.3: Aggregate Properties

Designation Class Application	1			2	3			
	10 10mm-HT & 10mm-LT	20 20mm - B	16 SMA	20 Soil Cement	20 & 25 Granular Base	40 Granular Base	63 Granular Sub-Base	80 Granular Sub-Base
+5000 µm with ≥2 fractured faces (% mass)	*	*	**	60 min	60 min	75 min	75 min	
Plasticity Index <400 µm	*	*	**	6 max	6 max	6 max	6 max	
Liquid Limit	*	*	**	25 max	25 max	25 max	25 Max	
LA abrasion wear (% mass)	*	*	**					
Soundness loss (% mass) Lightweight Pieces (% mass)	*	*	**	2 max	2 max	2 max	2 max	2 max

\*Note: See Section 02066 SGC HOT MIX ASPHALT CONCRETE for requirements

\*\*Note: See Section 02067 STONE MASTIC ASPHALT CONCRETE for requirements

### 2.1.2.2 Equipment

- **Crushers:** capable of producing aggregate as specified.
- **Truck Weigh Scales:** are to be furnished by the Contractor. Have the scales inspected and certified by the Weights and Measures Branch of Canada Consumer and Corporate Affairs prior to start of every construction season and as requested by the City, to ensure their accuracy.
- **Scale Tickets:** Supply truckers with scale ticket forms approved by the City.
- **Metric Sieves:** CAN/CGSB8.2M sieve sizes shall replace ASTM E11 sieves as per Table 2.1.4.

Table 2.1.4: Metric Sieves

CAN/CGSB8.2M Sieves (µm)	ASTM E11 Sieves (mm)
125 000	125.0
80 000	75.0
63 000	63.0
50 000	50.0
40 000	37.5
25 000	25.0
20 000	19.0
16 000	16.0
12 500	12.5
10 000	9.5
5 000	4.75
2 500	2.36
2 000	2.00
1 600	1.70
1 250	1.18
800	0.850
630	0.600
400	0.425
315	0.300
160	0.150
80	0.075

### 2.1.3 Execution

#### 2.1.3.1 Examination

Crushed aggregate shall consist of sound, hard and durable particles of sand, gravel and rock, free of elongated particles, injurious amounts of flaky particles, soft shale, coal, ironstone, clay lumps and organic and other deleterious material.

#### 2.1.3.2 Preparation

Adjust and modify aggregate as required to meet gradation requirements by aggregate splitting, elimination of fines, or blending with sand.

#### 2.1.3.3 Hauling Aggregate from City Stockpile

- Provide loading equipment and load aggregate at the designated City stockpile.
- Have loaded trucks weighed and provide weigh tickets to the City.
- Deliver aggregate to the jobsite and discharge at the designated location.
- The Contractor is not responsible for the quality of aggregate from a City stockpile. However, the materials are still required to pass standard requirements and must be tested and according to the same standards as those obtained from other suppliers.



## 2.2 CLEARING AND GRUBBING

### 2.2.1 General

#### 2.2.1.1 Content:

This section includes clearing designated areas of trees, shrubs and other vegetation, and removal of stumps and roots, and disposal of debris.

#### 2.2.1.2 Related Section:

- Grading Section 2.3

#### 2.2.1.3 Regulatory Requirements:

- There shall be no burning of debris on site unless permitted by the Engineer and done in conformity with applicable legislation and regulations.
- Maintain clearances from power lines as required by applicable legislation and regulations.

### 2.2.2 Products

#### 2.2.2.1 Materials

- **Salvage** : The Engineer may designate selected timber for salvage, and selected trees, shrubs and other plants for retrieval
- **Preservation**: The Engineer may designate selected trees and shrubs to remain undisturbed

### 2.2.3 Execution

#### 2.2.3.1 Clearing

- Trees and shrubs <150 mm diameter at ground level: Cut off at ground level.
- Trees and shrubs ≥150 mm diameter at ground level. Uproot completely and remove all trunk and primary roots
- Minimize damage to trees and shrubs designated for preservation. Fell trees away from preserved vegetation. Clear preserved area of all debris.
- Trim all branches from timber designated for salvage. Store clean timber at designated area on site.
- Remove vegetation and debris from areas outside excavation limits as designated. Make gradual transitions from cleared to undisturbed areas

### **2.2.3.2 Grubbing**

- Remove all roots and stumps >50 mm diameter to depth of topsoil. Where there is no topsoil, remove to a minimum depth of 300 mm below existing ground surface.
- Separate grubbed material from topsoil.
- Where permitted or directed by Engineer, chip grubbed material into 50 mm maximum dimension pieces and mix with native topsoil.

### **2.2.3.3 Disposal**

- Remove and dispose of all debris, rubbish, and material not designated for salvage.
- Where permitted by Engineer, chop cleared material and debris into 300 mm maximum dimension pieces and bury pieces at a designated location on site clear of any roadway structure and under a minimum of 600 mm of soil cover.

## 2.3 GRADING

### 2.3.1 General

#### 2.3.1.1 Content

This section includes the excavation of soil for construction of roadway and associated structures, the construction of fill, and the disposal of surplus and unsuitable materials.

#### 2.3.1.2 Related Sections:

- Pavement and Concrete Removal Section 2.4
- Clearing and Grubbing Section 2.2
- Subgrade Preparation Section 4.1

#### 2.3.1.3 Definitions:

- **Common Excavation:** Includes topsoil, clay, silt, sand, gravel and peat within a jobsite.
- **Borrow Excavation:** Includes select topsoil, clay, sand and gravel from off the jobsite for use as fill within a jobsite
- **Garbage Excavation:** Includes household, commercial and industrial refuse or any other deleterious material.
- **Fill:** Any earth structure built up by successive lifts of a specified material compacted to specified densities
- **Berm:** a type of fill for a specific purpose, such as for noise attenuation or landscaping, as indicated on the drawings.

### 2.3.2 Products

#### 2.3.2.1 Materials

- **Suitable Materials:** The Engineer will determine the suitability of excavated materials for use in embankments, subgrade, backfill, berms and any other purpose.
- **Salvageable Materials:** When directed by the Engineer, reserve and stockpile at designated locations topsoil, sand, gravel, surplus fill and other materials deemed salvageable by the Engineer.
- **Surplus Materials:** Remove and dispose of materials deemed surplus by the Engineer.
- **Unsuitable Materials:** Remove and dispose of peat, roots, stumps, topsoil, frozen soil, garbage and any other material deemed unsuitable by the Engineer.

### 2.3.2.2 Equipment

- Only vehicles licensed for highway use shall be used for hauling on developed roadways.
- Off-highway earthmoving equipment shall not travel along or across developed roadways, unless authorized in writing by the City before work starts.
- Equipment shall be adequately muffled to conform to the City of Edmonton's Bylaw 1460 Community Standards Bylaw Part III – Noise Control

### 2.3.3 Execution

#### 2.3.3.1 Excavation

- Where necessary, perform clearing and grubbing to Section 2.2 Clearing and Grubbing and remove designated pavement and concrete to Section 2.4 Pavement and Concrete Removal. Excavate to designated cross sections. Complete initial excavation from property line to property line, unless permitted otherwise by the Engineer. Exercise caution to preserve bank stability where necessary. Stage excavation to allow related work.
- **Use of Excavated Soil:** Use Engineerapproved excavated soil to construct embankments, subgrade, berms, boulevard fill, trench backfill and for other purposes as directed.
- **Borrow Excavation:** Where excavated suitable material is not sufficient for jobsite use, obtain additional material from a designated borrow site. If necessary, clear and grub the borrow site. Strip the site of topsoil and unsuitable materials. Excavate, load, haul and place where required.
- **Undercut:** When excavation exposes unsuitable materials below the subgrade elevation and the Engineer directs removal, excavate such materials using transition slopes no steeper than 10% along the road profile. Make the bottom of the cut level, with no loose material.
- **OverExcavation:** Where overexcavation occurs, restore grades by backfilling, compacting and regrading as directed by the Engineer. If over-excavation is the result of the Contractor's error, no claim shall be made for the excess excavation and grade restoration.

#### 2.3.3.2 Fill

- **Preparation:** Where necessary, clear and grub the base of fill, remove topsoil and other unsuitable materials and scarify the base to ensure bond with fill material.
- **Soil Moisture Alteration:** The required compaction can best be achieved if the soil is dried or moistened to within  $\pm 3\%$  of optimum moisture content.
- **Fill Placement and Compaction:** Place and spread fill material in successive horizontal lifts, each lift not exceeding 150 mm thickness when compacted. Compact each lift to the required density using suitable equipment.

- **Berm:** Unless indicated otherwise on drawings or directed by the Engineer, build up the berm by spreading layers of approved material not more than 300 mm thick. Grade each layer using at least three passes of the spreading equipment.
- **Boulevard:** Spread approved fill material in 150 mm lifts and fine grade.

### 2.3.3.3 Side Slopes

Trim slopes of cuts, fills and berms from top to bottom. Leave the base of the slope neatly trimmed by removing lumps or loose material, or by blending loose material into the base. Finish slopes true to designated alignment, grade and shape.

### 2.3.3.4 Field Quality Control

- **Grade Tolerances:** Check graded surfaces to ensure they meet a grade tolerance of  $\pm 25$  mm maximum variation from designated grade elevations and that crossfall and bottoms of ditches are graded to create positive flow.
- **When tolerance is exceeded:** Trim high areas to within tolerance and scarify low areas, backfill with approved material, compact to required density and regrade to within tolerance.
- **Density Requirements:**
  - **Maximum density:** as used in this section, is the dry unit mass of sample at optimum moisture content as determined in the laboratory according to ASTM D698 Method A.
  - The required density for fill (including berms) is a minimum of 95.0% of maximum density for each lift, or 98.0% of maximum density for lifts within 1.5 m of finished subgrade elevation on road right-of-way where uniform trench backfill is not placed.
  - **Testing Frequency:** The quality assurance laboratory will take a minimum of one field density test for each 2 000 m<sup>2</sup> of compacted lift, or approved alternate frequency, according to ASTM D1556, ASTM D2167, or ASTM D2922 for comparison with a maximum density determined according to ASTM D698 Method A.
  - Where subgrades/bases are not protected, density tests obtained prior to a rain event are obsolete and the lot must be retested.
  - **Noncompliance:** If a density test result is less than the required density, that test result is discarded and 3 retests shall be performed on the area represented by the failed test. The average of the 3 retests shall represent the density of that area. If this average is less than the required density, the area shall be reworked to the full depth of the lift, the soil moisture altered as necessary and re-compacted to the required density. If the area is not retested but is reworked and re-compacted the area shall be tested at normal testing frequencies. Additional 3rd party test results will not be accepted.

- If the lift is covered before the City has accepted the test results then the Contractor assumes the risk of uncovering and reworking the compacted lift.

#### **2.3.3.5 Protection**

- **Drainage:** If the work area floods, drain immediately by natural flow or by pumping into catch basins, manholes or ditches.
- Protect finished grades from damage, and repair and retest as required by the engineer if damaged.

## 2.4 PAVEMENT AND CONCRETE REMOVAL

### 2.4.1 General

#### 2.4.1.1 Content:

This section includes the removal of existing pavement structure and concrete, and salvage or disposal of materials

#### 2.4.1.2 Related Section:

Grading Section 2.3

### 2.4.2 Products

#### 2.4.2.1 Materials

- **Pavement Removal:** asphalt, concrete, gravel and soil cement layers.
- **Concrete Removal:** curb, curb and gutter, gutter, walk, ramp, crossing and other slabs
- **Salvageable Materials:** asphalt, concrete, gravel and soil cement rubble designated by the Engineer for salvage
- **Surplus Materials:** all debris from the removal operation and materials not designated by the Engineer for salvage.

#### 2.4.2.2 Equipment

- The use of drop hammer type breaking equipment is not permitted.
- Equipment shall be suitably muffled to conform to the the City of Edmonton's Bylaw 1460 Community Standards Bylaw Part III – Noise Control
- Only vehicles licensed for highway use shall be used for hauling on or across developed roadways.

### 2.4.3 Execution

#### 2.4.3.1 Breaking and Excavation

- **Sawcutting:** Where directed by the Engineer, or where indicated in the drawings or in the contract Special Provisions, sawcut the limits of removal on existing pavement and concrete to a depth necessary to produce a straight clean vertical edge through the full depth of the existing pavement structure or concrete before breaking. The Engineer will require re-sawing if this edge is not maintained straight, clean and vertical until new pavement or concrete is placed against it.

- Break asphalt, concrete and soil cement pavement layers into pieces with no dimension >750 mm.
- Break concrete curb, curb and gutter, gutter, walk and other slabs into pieces with no dimension >750 mm, including reinforcing bars if any.
- Excavate broken materials.

#### **2.4.3.2 Salvaging**

- The Engineer will determine the suitability of removed materials for salvage. The following will not be accepted for salvage:
  - Concrete with wire mesh.
  - Pavement and concrete contaminated with topsoil or clay.
  - Haul salvageable materials to designated locations.

#### **2.4.3.3 Surplus Materials**

Remove and dispose of all debris and surplus materials.



### 3. UTILITIES

#### 3.1 TRENCH BACKFILL

##### 3.1.1 General

###### 3.1.1.1 Content:

This section includes the excavating and backfilling trenches and cuts for sewer and water pipe, manholes, valve chambers, catch basins, subdrains, culverts and other underground utilities and structures

###### 3.1.1.2 Related Sections:

- Aggregate Section 2.1
- Pavement and Concrete Removal Section 2.4
- Grading Section 2.3
- Fillcrete Section 7.11
- Sewers Section 02535 – Volume 3: Drainage
- Manholes and Catch Basins 02631 – Volume 3: Drainage
- Topsoil Section 02910 – Volume 5: Landscaping
- Seed and Sod Section 02920 – Volume 5: Landscaping
- Trees, Shrubs and Ground Covers Section 02930 – Volume 5: Landscaping

###### 3.1.1.3 Regulatory Requirements:

The following legislation and related regulations shall be observed at all times:

- Alberta Occupational Health and Safety Act
- City of Edmonton Building Bylaws
- Explosives Act Canada

###### 3.1.1.4 Quality Assurance:

**Testing Standards:** The quality assurance laboratory will take density and other tests on compacted soil to the following standards as directed by the Engineer:

ASTM D698 Method A., ASTM D1556, ASTM D2167, ASTM D2922 and ASTM D3017.

##### 3.1.2 Products

###### 3.1.2.1 Materials:

- **Native Fill Material:** Material excavated from trench or from grading as described in Section 2.1- Aggregate and approved by the Engineer.
- Section 2.4 - Pavement and Concrete Removal.

- **Section 2.3 - Grading:** Fill material shall be free of stones larger than 200 mm, organic matter and other deleterious material.
- **Imported Fill Material:** Engineer approved material from off-site to supplement or replace insufficient or unacceptable material on-site. Fill material shall be free of stones larger than 200 mm, organic matter and other deleterious material.
- **Granular Fill:** to Section 2.1 - Aggregate as specified.
- **Fillcrete:** to Section 7.11 - Fillcrete as specified.
- **Pipe Bedding Material:** Consult individual pipe installation sections for material specifications.
- **Topsoil:** Engineer-approved material excavated from site or to Section 02910 - Topsoil.
- **Seed and Sod:** to Section 02920 - Seed and Sod Volume 5: Landscaping or re-use sod stripped from site if approved by the Engineer.

### 3.1.3 Execution

#### 3.1.3.1 Trenching

##### i. Trench Excavation

- Where indicated, remove existing pavement and concrete to Section 2.4 - Pavement and Concrete Removal.
- Excavate trench to indicated alignment and to width and depth required to achieve indicated elevations and to accommodate required bedding. Hand trim bottom of trench where required.
- The Engineer or the utility owner may require that a professional engineer design the method of support to existing or proposed utilities within the trench limits. Submit any required design drawings for the Engineer's or utility owner's review beginning trench excavation.
- The Engineer may limit the amount of trench to be opened or left open at any one time.
- Stockpile excavated material or imported fill at a safe distance from edge of trench.
- Dispose of surplus or otherwise non-useable excavated material offsite or as directed by the Engineer.

## ii. Trench Dimensions

- The depth of trench shall be as shown on the drawings. Unless indicated otherwise, the depth of trench shall be such that there is a minimum 2.44 m of cover from the designated curb top grade to the top of the pipe. If the minimum cover cannot be maintained, advise the Engineer and obtain instructions before proceeding.
- Cut back the walls of trench in strict compliance with the Occupational Health and Safety Regulations.
- For a vertical cut trench with sheeting, the width of trench shall be:
- **At the pipe springline:** a minimum width equal to the outside diameter of pipe plus 450 mm and a maximum width equal to the outside diameter of pipe plus 600 mm.
- **At ground level:** a maximum width of outside diameter of pipe plus 600 mm.
- Do not over-excavate beyond the specified limits. If the trench must be excavated deeper or wider than specified, obtain approval from the Engineer. No additional payment for over-excavation will be made unless authorized by the Engineer.

## iii. Trench Shoring

- Where the sides of the trench or excavation need to be sheathed, shored or braced to protect life, property, the work, structures adjacent to the work or for maintaining trench widths, the Contractor shall supply and place all material required at no additional cost. Strictly follow Occupational Health and Safety regulations or a professional geotechnical engineer's recommendations.
- If required, the Contractor shall engage the services of a qualified professional engineer (the design engineer) who is registered in Alberta to design and regularly inspect cofferdams, shoring, bracing and underpinning required for the work.
- Design and supporting data are to bear the stamp and signature of the design engineer. They shall be submitted to the Engineer at least two weeks prior to start of work. Reports of the design engineer's inspections shall be displayed in the engineer's site office.
- The design engineer responsible for the design of the temporary structures shall submit to the City proof of insurance coverage for professional liability, except where the engineer is an employee of the Contractor, in which case the Contractor shall submit proof that the work by the design engineer is included in the Contractor's insurance coverage.
- Construct temporary works to depths, heights and locations as required to prevent failure.

- **During backfill operations:**
- Unless otherwise indicated or directed by the Engineer, remove sheeting and shoring from the excavations. Do not remove bracing until backfilling has reached the level of such bracing. Pull sheeting in increments that will ensure compacted backfill is maintained at an elevation at least 500 mm above the toe of sheeting.
- When sheeting is required to remain in place, cut off tops at elevations indicated or as directed by the Engineer.
- Upon completion of the substructure construction, remove shoring and bracing and remove excess materials from site.
- Obtain any required permits from the authority having jurisdiction for the diversion of watercourses.
- Protect excavations and adjacent properties against cave-ins, shear failure, slides, undermining, erosion and settlement. Erect shoring, cribbing, bracing, sheet piling or planking as necessary to provide such protection. Place such work so as not to interfere with operations and independent of any footing.
- The contractor shall assume full responsibility for any failure, collapse or movement of shoring or bracing method, collapse of earth banks, trenches, manholes or other excavations.

#### **iv. Trenching in Poor Ground**

- If the bottom of the trench is in soil which, in an undisturbed state, has adequate bearing capacity, but becomes “quick” due to soil water pressure or becomes unstable due to the construction activity in the trench, the contractor shall over-excavate to a depth specified by the engineer, place geotextile fabric and cover with foundation granular material, all as specified by the engineer.
- If the bottom of the trench is in peat or other unsuitable foundation material, apply one of the following corrective measures as appropriate:
  - Over-excavate to suitable material and backfill with compacted gravel or washed rock to the underside of bedding if the amount of over-excavation is less than 0.5 m.
  - Backfill with fillcrete if the amount of over-excavation is 0.5 m to 1.0 m.
  - Do not over-excavate, but provide structural support for the pipe as specified by the engineer, if the depth to suitable foundation soil from the bottom of the pipe bedding is greater than 1.0 m.

## **v. Trenching in Rock**

- **Definitions of Rock:**

- Type A: Fractured sandstone or shale which can be broken by the backhoe being used for trenching.
- Type B: Rock which requires drilling and blasting or jackhammering, to break.

- Trenching: Excavate only to the trench dimensions 3.1.3.1 iii. The trench bottom in rock shall be 150 mm below the underside of pipe barrel. If blasting is required, obtain the necessary permits and the Engineer's written permission prior to blasting. Do not use blasting methods within 150 m of any water storage reservoir or pumping station, nor within 3 m of any underground utility. Haul away surplus excavated rock that is not suitable for backfill.

## **vi. Boring**

- In areas where machinery cannot be accommodated or where machinery might damage property or existing infrastructure, excavate by hand or by boring.
- Where designated on the drawings or ordered by the Engineer, bore under sidewalk, curb and gutter, roadway or existing utilities.
- Submit drawings and written procedure on how the borehole will be excavated, braced or cased and backfilled to the Engineer.

### **3.1.3.2 Excavation for Underground Structures**

- Excavations for structures shall conform to the Occupational Health and Safety Act.
- Do not over-excavate beyond the specified limits. If the excavation is larger in length or width than specified, advise the Engineer and obtain instructions.
- Advise the Engineer if the excavation is deeper than the specified limits. Fill the over-excavation with 15 MPa (28-day strength) concrete or proceed as directed by the Engineer.
- If, at the specified depth, unsuitable foundation material is encountered, advise the Engineer and obtain instructions. Over-excavation and replacement with competent backfill or a structural foundation may be required.
- Minimize disturbance of the native soil at foundation level. Do not use heavy equipment at the bottom of the excavation. If necessary, provide pads for the equipment. If soil that has adequate strength in an undisturbed condition is disturbed, advise the Engineer and obtain instructions.

- Where, at the specified depth, the soil has adequate bearing capacity in an undisturbed state, but becomes unstable due to ground water pressure, advise the Engineer. Over-excavate, place a geotextile fabric, fill to the specified depth with competent backfill material and compact, as instructed by the Engineer.
- Haul all unsuitable or surplus excavated material to an approved site for disposal.

#### **3.1.3.3 Dewatering**

- Keep the excavation free of water.
- Protect open excavations against flooding and damage due to surface run-off.
- Do not allow ground water to drain into water pipes.
- Water from the excavation or from a well point system shall be disposed of in accordance with the General Requirements or in a manner approved by the Engineer. Do not pump muddy water into City sewers. Obtain written approval for disposal of clean water into City sewers.
- Dispose of water in a manner not detrimental to public and/or private property or any portion of the work completed or under construction.

#### **3.1.3.4 Bedding**

- Place pipe bedding for sewers in accordance with the individual pipe installation sections.
- Place pipe bedding for water pipe in accordance with Section 02515 – Pipe Bedding Volume 4: Water.

#### **3.1.3.5 Backfilling and Compaction**

- Backfill the trench with approved fill material from the top of bedding to the designated subgrade elevation or existing ground level, whichever is lower.
- Place backfill in uniform horizontal lifts and compact each lift according to trench and backfill types in 3.1.3.6
- Remove any free water from a lift before placing the next lift of backfill.
- Uniform backfill, as defined in 3.1.3.7 iii, shall be used for all backfill placed in conjunction with new roadway construction, unless waived by the City.
- **Backfilling Alternatives:** The Engineer may consider alternative proposals from a professional geotechnical engineer to use special materials or methods that will achieve long term stability of trench backfill. Use only alternatives accepted by the Engineer, at no additional cost to the City.
- **Backfilling in Cold Weather:**

- The reference for shutdown temperatures shall be the temperature reported by Environment Canada.
- Do not start daily excavation, backfilling or compaction for open cut trenches under pavement when the average air temperature is expected to be  $-10^{\circ}\text{C}$  or lower or when the minimum air temperature is expected to be  $-20^{\circ}\text{C}$  or lower.
- For open cut trenches the shutdown temperature is  $-10^{\circ}\text{C}$ . If an approved trench covering system is used the shutdown temperature is  $-25^{\circ}\text{C}$ .
- Frozen ground shall be thawed by an approved ground burning method before commencing excavation. Remove all frozen materials from the trench including snow and ice.
- Do not backfill with frozen soil or with material containing ice, snow, straw, organic or other deleterious material.
- Limit the length of open trench ahead of the backfilled portion to 10 m.

### 3.1.3.6 Trench and Backfill Types

- **Type 1:** Backfill with native or imported fill material over bedding up to the designated subgrade or existing ground elevation, whichever is lower, in lifts not exceeding 300 mm when compacted. Compact each lift to the applicable requirements in 3.1.3.7 i, A to C.
- **Type 2:** Backfill with Designation 3, Class 20 granular fill (or other granular fill accepted by the Engineer) over bedding up to existing ground elevation if lower than the designated subgrade depth, in lifts not exceeding 300 mm when compacted and compact each lift to the requirements in 3.1.3.7, D. If designated subgrade elevation is level with or lower than existing ground, place native or imported fill material as the topmost 300 mm lift compacted to applicable requirements in 3.1.3.7 i, A to C.
- **Type 3:** Removed from Construction Specifications
- **Type 4:** Backfill with fillcrete to Section 7.11 – Fillcrete over bedding to the designated subgrade elevation.

### 3.1.3.7 Density Requirements

#### i. Reference Density:

- **Standard Proctor:** the maximum dry density obtained from a plot of the dry densities of multiple specimens at various moisture contents, moulded and compacted in the laboratory according to ASTM D698 Method A.

- **One-Mould Proctor:** the dry density of a single specimen moulded at the moisture content of field compaction and compacted in the laboratory according to ASTM D698 Method A.

**ii. Required Compaction**

Required trench backfill compaction, expressed as a minimum percent of standard Proctor density or of one-mould Proctor density, is defined in Table 3.1.1.

**Table 3.1.1: Required Compaction**

Required Compaction	Backfill Zone
<b>A. Under existing or proposed road, alley, walk, street light or similar structure and within a distance from such structure equal to trench depth*:</b>	
98.0% of standard or 100.0% of one-mould	From designated subgrade elevation or existing ground level, whichever is lower, to 1.5 m below.
95.0% of standard or 97.0% of one-mould	More than 1.5 m below.
<b>B. Adjacent to existing improved road, alley, walk, street light or similar structure and within a distance from the improvement equal to trench depth:</b>	
92.0% of standard	Through full depth of trench.
<b>C. Outside defined areas:</b>	
90.0% of one-mould	Through full depth of trench.
<b>D. Trench and backfill Type 2:</b>	
95.0% of standard	Through full depth of trench.

\*Inclusive of boulevards located between structures, such as between a road and adjacent Shared Pathway.



**iii. Moisture Content Requirements**

The maximum permitted moisture contents for compacting backfill, based on one-mould proctor tests, shown in Table 3.1.2.

**Table 3.1.2: Moisture Content Requirements**

Maximum Moisture Content	Backfill Zone
<b>A. Conventional trenching techniques:</b>	
Plastic Limit + $\frac{\text{Plasticity Index}}{3}$ to a maximum of 5% above Plastic Limit	From designated subgrade elevation or existing ground level, whichever is lower, to 1.5 m below.
Plastic Limit + $\frac{\text{Plasticity Index}}{3}$ to a maximum of 8% above Plastic Limit	More than 1.5 m below.
<b>B. Uniform backfill:</b>	
Plastic Limit + $\frac{\text{Plasticity Index}}{2}$ to a maximum of 8% above Plastic Limit	From designated subgrade elevation or existing ground level, whichever is lower, to 1.5 m below.
Plastic Limit + $\frac{\text{Plasticity Index}}{2}$ to a maximum of 8% above Plastic Limit	More than 1.5 m below.
<b>C. Alternative backfill techniques and materials</b>	
As defined by a professional geotechnical engineer, to achieve long term stability of trench backfill	Through full depth of trench

The uniform backfill moisture requirements shall apply where the upper 1.5 m of the subgrade is excavated beyond the limits of the trench to include any roadway structures, including monolithic or boulevard walk. The excavated material, if acceptable to the Engineer, shall be replaced and re-compacted in lifts not exceeding 300 mm compacted thickness, to the requirements of ii, A.

**iv. Minimum Testing Frequency:**

- Trench greater than 15 m in length: A minimum of 2 density tests per 600 mm of trench depth per 100 m of trench length. The tests shall be representative of the entire length, width and depth of trench backfill, including areas around catch basins, manholes, valves and service connections. The Engineer or a qualified geotechnical representative may require additional testing as deemed necessary.
- Trench 15 m or less in length: A minimum of 3 density tests evenly spaced through the depth and length of the trench or as directed by the Engineer.
- Where subgrades/bases are not protected, density tests obtained prior to a rain event are obsolete and the lot must be retested.

**v. Non-compliance:**

If a density test result is less than the required density, that test result is discarded and 3 retests shall be performed on the area represented by the failed test. The average of the 3 retests shall represent the density of that area. If this average is less than the required density, the area shall be reworked to the full depth of the lift, the soil moisture altered as necessary and re-compacted to the required density. If the area is not retested but is reworked and re-compacted the area shall be tested at normal testing frequencies.

**3.1.3.8 Restoration and Cleanup**

- Restore or replace to Section 02930 - Trees, Shrubs and Ground Covers – Volume 5: Landscaping , all pavement structures, sidewalk and curb and gutter damaged or removed during trenching and backfilling, unless directed otherwise by the Engineer.
- Restore or replace in an approved manner all fences, poles, shrubs, grass and other structures damaged or removed during trenching and backfilling, unless directed otherwise by the Engineer.
- Remove and dispose of all debris, surplus fill and unused material excavated from the trench.
- Leave work site clean and as nearly as possible in original condition.

## 3.2 UTILITY CUT RESTORATION

### 3.2.1 General

#### 3.2.1.1 Content

This section includes the removal and restoration of road, laneway, curb, gutter, walk, and crossing disturbed by a utility cut.

#### 3.2.1.2 Related Sections

- Section 2.1 - Aggregate
- Section 6.1 – SGC Hot-Mix Asphalt Concrete
- Section 2.4 Pavement and Concrete Removal
- Section 3.1 - Trench and Backfill
- Section 4.1 - Subgrade Preparation
- Section 4.2 - Cement-Stabilized Subgrade
- Section 7.4 - Concrete Base
- Section 4.4 - Plant-Mix Soil Cement
- Section 5.1 - Granular Base Courses
- Section 6.3 – SGC Hot-Mix Asphalt Paving
- Section 7.5 - Concrete Pavement
- Section 7.2 - Concrete Sidewalk, Curb and Gutter, and Slabs
- Section 6.6 - Pavement Cold Milling
- Section 6.7 - Liquid Asphalt Coats
- Section 7.1 - Cement Concrete

#### 3.2.1.3 Definitions

- **Utility Cut:** Utility work undertaken by City of Edmonton departments, other government agencies, private companies, or individuals involving trenching or cutting across or along, or in any way causing damage to, existing roadway infrastructure on road right-of-way, in particular, road, laneway, curb, gutter, walk, and crossings.
- **Drive Lane:** That width of road delineated for driving by lane markings. If there are no lane markings, one quarter of the road width is deemed to be a drive lane. The full width of a laneway is considered to be one drive lane.
- **Streetscape Location:** An area where improvements are made to roadway infrastructure specifically for the purpose of beautification.

#### 3.2.1.4 Road Information

- Road Classification Map: (Appendix A to the Transportation System Bylaw) available from the City Planning, Urban Form and Corporate Strategic Development, Edmonton Tower 10111 -104 Avenue

- Existing Pavement Structure and Visual Condition Index: available from Parks and Roadways Operations, City Operation

### 3.2.2 Products

#### 3.2.2.1 Materials

- **Hot-Mix Asphalt:** to Section 6.2 – SGC Hot Mix Asphalt Concrete.
- **Concrete:** to Section 7.1 – Cement Concrete

### 3.2.3 Execution

#### 3.2.3.1 Road and Laneway

- **Pavement Removal:**
  - Remove the full pavement structure disturbed by a utility cut, to a minimum width of 300 mm (Drawing 1000). Remove all cracked or disturbed pavement leaving a clean straight vertical butting edge for the replacement paving materials.
  - Full-depth sawcutting of pavement structure shall include asphalt, concrete and soil cement layers.
  - Sawcutting Asphalt <100 mm Thick: Remove disturbed pavement by suitable means without presawing. Sawcut full-depth prior to pavement replacement, to provide a clean straight vertical edge at the time replacement paving materials are placed. In cold weather, when sawcutting is not practical, sawcutting before pavement replacement is not required if there is a clean straight vertical edge against which the replacement paving materials can be placed.
  - Sawcutting Asphalt  $\geq$ 100 mm Thick or Concrete Base: Sawcut full-depth prior to pavement removal, to prevent disturbance of the adjacent pavement structure. Re-saw prior to pavement replacement if adjacent pavement is cracked or disturbed, or if a clean straight vertical edge is not maintained. In cold weather, when sawcutting is not practical, and in emergency repair situations, disturbed pavement may be removed by suitable means without pre-sawing. Sawcut prior to pavement replacement when whether permits, to obtain a clean straight vertical edge against which the replacement paving materials can be placed.
  - **Removal Limits:**
    - Asphalt and Soil Cement: Remove pavement structure to the edge of pavement, if the edge of the utility cut is less than 1.0 m from the edge of pavement on freeways and arterials, or less than 1.5 m from the edge of pavement on collector, industrial and residential roadways, and laneways.

- One-Course Concrete and Concrete Base: Remove pavement structure to the edge of pavement, if the edge of utility cut is less than 1.0 m from the edge of pavement, a joint, or an existing crack. In one-course concrete streetscape locations, remove concrete pavement to the nearest joint.
- Avoid sharp angles in cutting the pavement in order to allow continuous compaction of replacement material longitudinally along the entire length of the cut (Drawing 1000)
- Remove the pavement structure that is undermined by the failure of the sides of a utility cut.
- **Trench Backfill:** Refer to Section 3.1 - Trench and Backfill.
- **Replacement Pavement Structure**
  - **For Asphalt Surfaced Road and Laneway:** Place a non-woven geotextile and compact a minimum of 150mm granular base course (Designation 3, Class 20) atop the backfill in accordance with Section 5.1 Granular Base Course and place hot-mix asphalt concrete of the type and thickness as follows:

**Table 3.2.1: Roadway Asphalt Type and Thickness**

Roadway Class	Surface Asphalt	Base Asphalt
Arterial Roadway or Freeway	50 mm, 10mm-HT	250 mm, 20mm-B
Collector or Industrial Roadway	50 mm, 10mm-HT	175 mm, 20mm-B
Commercial Laneway	50 mm, 10mm-HT	175 mm, 20mm-B
Residential Street or Laneway	150 mm, 10mm-LT (minimum)	

Place hot-mix asphalt to Section 6.3 – SGC Hot Mix Asphalt Paving. Use appropriate equipment to achieve the required compaction in confined space.

If a utility cut is to be done in a current construction year, the work must be coordinated with Transportation Infrastructure Delivery and Building Great Neighbourhood Delivery.

- **For One-Course Concrete and Concrete Base Road and Laneway:** Place Cement concrete, class A one-course pavement to Section 7.5 - Concrete Pavement, or Class B concrete base to Section 7.4 – Concrete Base, of a thickness matching the existing concrete one-course pavement or base. Tie the new concrete to the existing concrete using 15M deformed bars, 300 mm long, at 750 mm spacing on each side of the utility cut. Stagger the tie bars from side to side, with the bars extending 150 ±25 mm into the existing concrete at mid-depth (Drawing 1504).

- **Alternate Structure:** The Engineer may approve an alternate replacement pavement structure if the entire width of the road or laneway is being replaced.
- **For Gravel Road:** Place 200 mm of 20 mm crushed aggregate (Designation 3 Class 20C) on a 150 mm prepared subgrade.
- **For Oiled Road:** Place 150 mm of approved oil-mix material on a 150 mm prepared subgrade.
- **Overlay on Adjacent Pavement:**
  - Mill the adjacent asphalt pavement 50 mm deep and overlay to the full width of any drive lane or lanes disturbed by the utility cut with 50 mm of 10mm-HT, or with 50 mm of 10mm-LT on residential streets or laneways, when a utility cut runs more than 30 m longitudinally on an asphalt road or laneway (Drawing 1020-1024), or a number of utility cuts run transverse to the pavement edge over a longitudinal distance of 50 m or greater and are at intervals of 15 m or less (edge of cut to edge of cut) on any drive lane (Drawing 1020-1024).
  - **Roads and Laneways To Be Overlaid:**

All freeways, arterial and industrial roadways. Collector roadways and residential streets, and laneways having a visual condition index (VCI) of 5.0 or greater. Overlay to Section 6.3 – SGC Hot-Mix Asphalt Paving. Ensure that the weather limitations are strictly adhered to.

### 3.2.3.2 Concrete Curb, Curb and Gutter, Walk, and Crossing

- **Cutting and Removal of Concrete:**
  - Remove concrete work disturbed by a utility cut or undermined by the failure of the sides of a utility cut.
  - Before removal, sawcut the concrete through its full depth, leaving a straight vertical face.
  - Concrete may be broken at crack-control joints without sawcutting provided a straight vertical face free of loose material remains.
- **Curb, Curb and Gutter:**
  - Remove any length less than 1.5 m to the next crack-control joint.
  - Remove a minimum length of 600 mm on both sides of a catch basin to be moved or installed.

- **Walk**

- Remove walk in full panels to the nearest crack-control or surface joints, transverse or longitudinal.
- Walk  $\geq 3$  m wide without Longitudinal Joints: If the utility cut runs parallel to the walk, divide the walk longitudinally into equal 1.5 m minimum width strips. Remove only the strip or strips disturbed by the utility cut.
- **Monolithic Walk:**
- Walk  $< 3$  m wide: Remove the full width of the walk including the curb and gutter.
  - Walk  $\geq 3$  m wide: Curb and gutter may remain if in good condition. Remove walk as in stated above.

- **Crossing**

- On Monolithic or Curblineline Walk: If the crossing has crack-control joints, remove to the nearest joint; remove remaining crossing if cracked or less than 1.5 m in least dimension. If crossing has no crack-control joints, remove to the width of the utility cut.
- On Boulevard Walk or Crossing Pad: Remove a minimum section of 1.5 m by 1.5 m. Remove remaining crossing with less than 1.5 m in least dimension. There shall be only 1 or 2 panels in the crossing when replacement work is complete.

- **Curb Ramp**

- Remove the entire curb ramp.

- **Replacement Concrete**

- Construct replacement concrete work to Section 7.2 – Concrete Sidewalk, Curb and Gutter, and Slabs.
- Construct a curb ramp at any street corner with walk being replaced even if no curb ramp existed before.

## 4. BASE PREPARATION

### 4.1 SUBGRADE PREPARATION

#### 4.1.1 General

##### 4.1.1.1 Content

This section includes working and compacting subgrade soil.

##### 4.1.1.2 Related Sections

- Grading Section 2.3
- Cement Stabilized Subgrade Section 4.2
- Proof Rolling Section 4.3

##### 4.2.2.3 Definition

**Prepared subgrade:** soil immediately below a pavement structure or slab, compacted to a depth of 150 mm, 300 mm or as specified.

##### 4.1.1.4 Quality Assurance

- **Maximum Density:** the dry unit mass of a soil sample at optimum moisture content as determined in the laboratory according to ASTM D698 Method A.
- **Required Density:** a minimum of 100.0% of the maximum density for each 150 mm lift of subgrade under the full width of the cross section for pavement structures, concrete curb, concrete gutter, concrete monolithic walk, private, commercial and alley crossings and asphalt walks/bikeways and a minimum of 97.0% of the maximum density for each 150 mm lift of subgrade under concrete separate walks, curb ramps, slabs, and walk made of concrete pavers, brick pavers, or granular materials.
- **Testing Frequency:** the quality assurance laboratory will take a minimum of one field density test for each 1 000 m<sup>2</sup> of compacted subgrade lift according to ASTM D1556, ASTM D2167, or ASTM D2922 for comparison with a maximum density determined according to ASTM D698 Method A or as directed by the Engineer.
- Where subgrades/bases are not protected, density tests obtained prior to a rain event are obsolete and the lot must be retested.
- **Proof Rolling:** a proof roll of the finished subgrade will be required to confirm adequate bearing capacity of the subgrade soils. The proof roll shall be supervised by the City, and must be performed in accordance with Section 4.3 – Proof Rolling or the engineer’s recommendations.



## 4.1.2 Products

### 4.1.2.1 Materials

Use only compacted clay subgrade soil with no deleterious material approved by the City.

### 4.1.2.2 Equipment

**Equipment:** various pieces of equipment designed for and capable of disking, scarifying, spreading, spraying water, compacting and trimming soil to specified depth.

## 4.1.3 Execution

### 4.1.3.1 Subgrade Preparation

- Loosen soil to required depth. Work soil with cultivating and mixing equipment until soil is pulverized into pieces no larger than 25 mm maximum dimension, exclusive of stones.
- The required compaction can generally best be achieved if the soil is dried or moistened to within  $\pm 3\%$  of the optimum moisture content before compacting.
- If the Engineer determines that it is not practical to dry an otherwise suitable soil, the Engineer may order soil stabilization to Section 4.2 - Cement Stabilized Subgrade. Spread soil in lifts not exceeding 150 mm when compacted. Compact each lift to the required density in 4.1.1.4 – Required Density.
- Leave the surface of the compacted subgrade slightly higher than required elevation; then trim to design crown and grade. Leave finished surface even and free of depressions, humps and loose material.

### 4.1.3.2 Field Quality Control

- Check finished surface of subgrade to ensure it meets the following tolerances:
  - Grade: 6 mm maximum variation above designated elevation.  
25 mm maximum variation below designated elevation.
- When Tolerance Exceeded
  - Trim high spots and refinish surface to within tolerance.
  - Add approved material to low areas, scarify and blend to full subgrade depth, re-compact to required density and refinish surface at the contractor's expense. Alternatively, fill low areas with extra thickness of subsequent granular sub-base or base course at the contractor's expense.
- If a density test result is less than the required density, that test result is discarded and 3 retests shall be performed on the area represented by the failed test. The average of the 3 retests shall represent the density of that area. If this average is less than the required

density, the area shall be reworked to the full depth of the lift, the soil moisture altered as necessary and re-compacted to the required density. If the area is not retested but is reworked and re-compacted the area shall be tested at normal testing frequencies.

- The Contractor shall assume the risk of uncovering and reworking the subgrade if it is covered before the City has accepted test results thereof.

#### **4.1.3.3 Protection of Finished Work**

- Do not permit vehicular traffic over the prepared subgrade.
- If folding of the subgrade occurs, drain immediately by natural flow or by pumping to catch basins, manholes, or ditches. This shall be done at the expense of the Contractor.
- Maintain protection of prepared subgrade until subsequent granular sub-base or base course is placed. Repair and retest as required by the engineer if damaged.

## 4.2 CEMENT STABILIZED SUBGRADE

### 4.2.1 General

#### 4.2.1.1 Content:

This section includes: the supply and spreading of Cement onto subgrade soil, and the mixing soil, cement and water; compacting and finishing the stabilized subgrade.

#### 4.2.1.2 Related Sections

- Grading Section 2.3
- Subgrade Preparation Section 4.1
- Proof Rolling Section 4.3

#### 4.2.1.3 Definition

Cement-Stabilized Subgrade: soil immediately below a pavement structure or slab, mixed with Cement and compacted to a depth of 150 mm, 300 mm, or as specified.

#### 4.2.1.4 Quality Assurance

- **Maximum Density:** the dry unit mass of a soil sample at optimum moisture content as determined in the laboratory according to ASTM D698 Method A.
- **Required Density:** a minimum of 100.0% of the maximum density for each 150 mm lift of stabilized subgrade.
- **Testing Frequency:** The quality assurance laboratory will take a minimum of one field density test for each 1 000 m<sup>2</sup> of compacted subgrade lift according to ASTM D2167 or ASTM D2922 for comparison with a maximum density determined according to ASTM D698 Method A or as directed by the Engineer.
- Where subgrades/bases are not protected, density tests obtained prior to a rain event are obsolete and the lot must be retested.
- **Proof Rolling:** a proof roll of the finished subgrade will be required to confirm adequate bearing capacity of the subgrade soils. The proof roll shall be supervised by the City, and must be performed in accordance with Section 4.3 – Proof Rolling or the engineer’s recommendations.

### 4.2.2 Products

#### 4.2.2.1 Materials

- Cement: to CSA A3000, Type GU/GUL/GULb – General use cement.

- Water: may be obtained from City fire hydrants according to the General Requirements of Section 2.3 – Grading. Other water sources are subject to the City's approval.

#### 4.2.2.2 Equipment

- **Cement Spreader:** capable of spreading cement uniformly.
- **Mixing Equipment:** designed for and capable of mixing the full depth of the subgrade in one pass, subject to the City's approval.

### 4.2.3 Execution

#### 4.2.3.1 Preparation

- Subgrade areas to be stabilized will be indicated on plans or designated by the Engineer.
- Pre-grade and shape soil to designated grade and cross section.

#### 4.2.3.2 Stabilization

- Loosen soil to required depth. Work soil with cultivating and mixing equipment until soil is pulverized into pieces no larger than 25 mm maximum dimension, exclusive of stones.
- Dust Control: Contain cement dust within site area. Do not spread cement during or when there is imminent danger of high winds or rain.
- Spread and blend cement into soil at a rate of 10 kg/m<sup>2</sup> of 150 mm compacted depth, or as directed by the Engineer, but in no case should the cement exceed 20 kg/m<sup>2</sup>. In the event that it is determined, in the field that more than 20 kg /m<sup>2</sup> is required it is recommended that the situation be examined by a qualified geotechnical engineer and approved by the City to determine the requirements moving forward. In any case no more than 30kg/m<sup>2</sup> will be allowed.
- Add sufficient water to the blended soil and cement to best achieve the required compaction. Mix until homogeneous.
- Spread the mixture uniformly in lifts of 150 mm compacted thickness. Compact each lift to the required density.
- Complete mixing, compaction and finishing on the same day.
- Water may be lightly sprayed with a pressurized distributor for surface finishing.

- Leave the surface of the compacted subgrade slightly higher than required elevation; then trim to design crown and grade. Leave finished surface even and free of depressions, humps or loose material.
- Material should not be frozen at the time of stabilization.

#### **4.2.3.3 Field Quality Control**

- Check finished surface of stabilized subgrade to ensure it meets the following tolerances:
  - Grade: 6 mm maximum variation above design elevation.  
25 mm maximum variation below design elevation.
- When Tolerance Exceeded
  - i. Trim high spots and re-work entire structure to within tolerance.
  - ii. Add approved mixed material to low areas, scarify and blend to full subgrade depth, re-compact to required density and refinish surface. Alternatively, fill low areas with extra thickness of subsequent sub-base or base course.
  - iii. If a density test result is less than the required density, that test result is discarded and 3 retests shall be performed on the area represented by the failed test. The average of the 3 retests shall represent the density of that area. If this average is less than the required density, the area shall be reworked to the full depth of the lift, the soil moisture altered as necessary and re-compacted to the required density. If the area is not retested but is reworked and re-compacted the area shall be tested at normal testing frequencies.
  - iv. The Contractor shall assume the risk of uncovering and reworking the subgrade if it is covered before the City has accepted test results thereof.

#### **4.2.3.4 Protection of Finished Work**

- Do not permit vehicular traffic over the stabilized subgrade.
- If subgrade floods, drain immediately by natural flow or by pumping to catch basins, manholes, or ditches. This shall be done at the expense of the Contractor.
- Maintain protection of stabilized subgrade until subsequent sub-base or base course is placed. Repair and retest as required by the engineer if damaged.

#### 4.2.3.5 Reconstruction

- Break up and pulverize rejected stabilized subgrade into no larger than 25 mm pieces. Spread the pulverized material for addition of cement.
- Add cement as follows:
- For a section reprocessed within 24 hours and 48 hours of the original construction, add 50% of the original cement content.
- For a section reprocessed more than 48 hours following the original construction, add 100% of the original cement content.
- Process the new mixture using pulverization equipment, to Section 5.3 - Full Depth Reclaimed Base Course

## 4.3 PROOF ROLLING

### 4.3.1 General

#### 4.3.1.1 Content:

This section includes the verification of the stability and uniformity of the subgrade compaction. This procedure shall be performed in the presence of the Engineer or it's designate. Actual requirements for representation on the project site for the proof rolling operation will be site dependent.

#### 4.3.1.2 Related Sections:

- Grading Section 2.3
- Subgrade Preparation Section 4.1
- Cement Stabilized Subgrade Section 4.2

### 4.3.2 Execution

#### 4.3.2.1 Equipment

The vehicle used to perform the Proof rolling shall conform to the following:

- Tandem axle, dual wheel dump truck.
- Tire pressure shall be no less than 90 percent of the manufacturer's recommended maximum inflation.
- The minimum gross weight of the loaded truck shall be 24,800 kg. A weigh scale slip shall be available upon request to confirm the truck weight.

#### 4.3.2.2 Procedure

- The proof rolling vehicle shall be operated at a rate not to exceed 3.0 to 6.0 km/hr. or a comfortable walking pace. Adjust the speed to allow the Inspector/Engineer to measure any deflections and/or areas of rutting.
- Operate the proof roll in a pattern so that all areas are loaded with at least one pass of the Proof rolling vehicle.
- After proof rolling, check the subgrade for conformance to the plans, and correct all surface irregularities. Re-shape the subgrade to specified tolerances.

#### 4.3.2.3 Evaluation

- i. There shall not be any discernible rutting during the proof roll. Rutting exceeding 100 mm shall be considered a failure and will require the subgrade to be reworked and compacted.
- ii. There shall not be any discernible deflection (pumping) of the subgrade during the proof roll. Deflections exceeding 100 mm shall be considered a failure, and will require the subgrade be reworked and compacted.
- iii. Rutting and/or deflections in excess of 100 mm must be reviewed by a Geotechnical Engineer who is to provide recommendations as to how to meet density and performance requirements.
- iv. When remedial work is performed under Item 4.3.2.3 iii, a final proof roll must be performed upon completion of the work. If remedial work is performed as directed under Item 4.3.2.3 i or ii, a second proof roll may be required at the discretion of the Engineer or his designate.



## 4.4 PLANT MIX SOIL CEMENT

### 4.4.1 General

#### 4.4.1.1 Content:

This section includes: the production and supply of plant-mixed aggregate, Cement and water, and the spreading the mixture, compacting and finishing the soil cement base or sub-base.

#### 4.4.1.2 Related Sections:

- Aggregate Section 2.1
- Liquid Asphalt Coats Section 6.7

#### 4.4.1.3 Definition

- **Soil cement:** Granular base or sub-base course stabilized with Cement and constructed to this Section.
- **Maximum Density:** The dry unit mass of a sample at optimum moisture content as determined in the laboratory according to ASTM D558 Method B.

#### 4.4.1.4 Submittals

- **Mix Design**
  - Submit a mix design based on the PCA Shortcut Method B, performed by a qualified laboratory, to the Technical Services Section, Integrated Infrastructure Services at least 7 days prior to commencing production.
  - Submit the following information with the mix design:
    - i. a minimum of one sieve analysis for each 2 000 tonnes of aggregate in the stockpile and the overall average gradation of the stockpile,
    - ii. the mass of cement per tonne of dry aggregate and
    - iii. the mass of water per tonne of dry aggregate.

- **Job Mix Formula**

Submit the proportions of materials and plant settings based on the approved mix design to the Technical Services Section at least 7 days prior to production.

#### 4.4.1.5 Quality Assurance

- **Thickness:** At the City's request, the quality assurance laboratory will take one or more sets of cores from suspect soil cement, each set comprising 3 cores whose average thickness represents not more than 1 000 m<sup>2</sup> of soil cement per supplier per day.
- **Required Density:** Minimum 95% of maximum density for each lift where soil cement is used under concrete curb and gutter in a rehabilitation scenario, or in front of the curb and gutter in a foamed asphalt scenario where no subgrade preparation is carried out. In all other cases a minimum of 100% of Maximum dry density for each lift of Soil Cement is required.
- **Representative Tests:** The quality assurance laboratory will take a field density test, representing not more than 1 000 m<sup>2</sup> of soil cement per supplier per day, according to ASTM D2167 or ASTM D2922 for comparison with a maximum density determined according to ASTM D558 Method B. If a tested density fails, 2 more tests will be taken from the same area and the average of the 3 tests will represent that area.
- The quality assurance laboratory will conduct plant checks, sampling and testing.
- Where subgrades/bases are not protected, density tests obtained prior to a rain event are obsolete and the lot must be retested.
- **Plant Check:** Soil cement plant inspections will be conducted at random to check settings, operation, materials and mixture produced. The City will order the plant shut down if deficiencies are found, including deviation from the approved jobmix formula, segregation in the mix, or inconsistent plant operation.
- **Compressive Strength Test:** Samples of soil cement will be taken at the plant or at the jobsite. Specimens will be moulded on site or in the laboratory into 101.6 mm diameter by 116.4 mm height cylinders using the compactive effort specified in ASTM D558 Method B. The specimens will be cured for 7 days to ASTM D1632:9.1. After 7 days curing, the specimens will be tested for compressive strength to ASTM D1633 Method A. At least one strength test will be taken per 500 tonnes of mix per supplier per day.

#### 4.4.2 Products

##### 4.4.2.1 Materials

- Cement: to CSA A3000, Type GU/GUL/GULb – General use cement.
- Aggregate: to Section 2.1 - Aggregate, Designation 2 Class 20.
- Water: potable, approved by the City.
- Curing Seal: liquid asphalt prime coat, to Section 6.7 - Liquid Asphalt Coats.

#### 4.4.2.2 Mixing Plant

Mixing Plant: subject to the City's approval; capable of producing a uniform mixture; and equipped with synchronized metering devices and feeders to maintain correct proportions of aggregate, cement and water.

#### 4.4.2.3 Mix Design

The mix design shall meet the following criteria:

- Minimum compressive strength: 3.0 MPa at 7 days.

#### 4.4.2.4 Mix Production

- **Job Mix Formula**

Display the approved job-mix formula in sight of the plant operator. Failure to display the job-mix formula will result in a shutdown order by City. Do not make changes to the formula without the City's approval.

- **Mixing**

Mix aggregate, cement and water to obtain uniformity in cement content and moisture content without segregation of aggregate.

### 4.4.3 Execution

#### 4.4.3.1 Preparation

- Have the prepared or stabilized subgrade, or the prepared subbase, inspected by the City before placing soil cement.
- Repair imperfections to the prepared subgrade or subbase and clean the surface of debris and loose material.
- Moisten the subgrade or the subbase surface without creating mud or ponding water, to minimize absorption of water from deposited soil cement mix.

#### 4.4.3.2 Placing Mixture

- Transport the soil cement mixture to the site in trucks with protective covers in place until discharge, to minimize evaporation.
- Do not place the soil cement mixture when the subgrade or subbase is frozen, or when the ambient air temperature is likely to drop below 2°C within 24 hours. Protect the soil cement from freezing for at least 7 days after placement.

- Deposit the mixture within one hour after plant mixing and immediately spread the mixture in sufficient depth to achieve the designated cross-section and thickness when compacted. Do not dump the mixture into piles or windrows.
- Limit the time interval between adjacent spreads to not more than 30 minutes. If the time interval is exceeded, form a construction joint as per 4.3.3.3 – Construction Joint.

#### 4.4.3.3 Compaction and Finishing

- Begin compaction within one hour of plant mixing and complete finishing within 2 hours of plant mixing.
- Keep the surface moist at not less than optimum moisture content during compaction, finishing and until the surface seal is applied.
- Compact mixture in one lift to the required density. Spread and compact the mixture in two lifts if the designated thickness is greater than 200 mm.
- Finish the compacted surface to be smooth and dense, free of compaction planes, cracks, ridges, equipment imprints, segregation or loose material and to the correct grade and cross-section.
- **Smoothness and Grade:** Check the finished surface with a 3 m straightedge and against survey stakes to ensure that surface and grade tolerances are met. Rework deficient areas. Filling low spots with a thin application of the soil cement mixture is not permitted.
- Apply curing seal to the surface after finishing.
- **Construction Joint:** Place a construction joint between adjacent spreads more than 30 minutes apart and at the end of a day's work. Trim the compacted mixture to a clean vertical edge along a straight line perpendicular to the centerline of the road or along a straight line between parallel spreads.

#### 4.4.3.4 Field Quality Control

- Surface Tolerance: 12 mm maximum variation under 3 m straightedge.
- Grade Tolerance: 6 mm maximum variation above designated elevation and  
15 mm maximum variation below designated elevation.
- Where surface and grade tolerances are exceeded:
- Grind down excessively high areas without destroying the surface, provided specified thickness is met.

- Compensate low areas with extra thickness of subsequent paving course. This will be done at the expense of the Contractor.
- Deficient Thickness: If the average core thickness is deficient, that area of soil cement will be assessed a pay factor according to Table 4.4.1.

**Table 4.4.1: Soil Cement Thickness Pay Factors**

THICKNESS DEFICIENCY (mm)	PAY FACTOR (% of Contract Price)
15	100.0
16	97.8
17	95.3
18	92.3
19	88.8
20	84.8
21	80.0
22	74.5
23	68.0
24	60.0
25	50.0
>25	Remove and replace or reconstruct

- **Excess Thickness:** Soil cement with excess thickness may be accepted if surface and grade tolerances are met, but no claim for additional payment will be accepted.

**4.4.3.5 Soil Cement Density**

- Deficient Density: If the average density is less than the required density, that area of soil cement will be assessed a pay factor according to Table 4.4.2.

**Table 4.4.2: Soil Cement Density Pay Factors (100% Compaction Requirement)**

AVERAGE PERCENT (Of Maximum Density)	PAY FACTOR (% of Contract Price)
99.0	100.0
98.8	99.8
98.6	99.4
98.4	98.8
98.2	97.9
98.0	96.8
97.8	95.5
97.6	94.0
97.4	92.2
97.2	90.1
97.0	87.8
96.8	95.3
96.6	82.5
96.4	79.5
96.2	76.2
96.0	72.7
95.8	68.9
95.6	64.7
95.4	60.2
95.2	55.3
95.0	50.0
<95.0	Remove and replace or reconstruct

**Table 4.4.3: Soil Cement Density Pay Factors (95% Compaction Requirement)**

AVERAGE PERCENT (Of Maximum Density)	PAY FACTOR (% of Contract Price)
95.0	100.0
94.8	95.5
94.6	90.0
94.4	85.5
94.2	80.0
94.0	75.5
93.8	70.0
93.6	65.5
93.4	60.0
93.2	55.5
93.0	50.0
<92.0	40.0

- The Contractor shall assume the risk of uncovering and replacing the soil cement if it is covered before the City has accepted the test results.
- Deficient Strength: If strength test results are less than 3.0 MPa, the Contractor will be required to perform immediate corrective measures. In addition, if the average strength of any 3 consecutive cylinders is below 2.0 MPa, payment for soil cement in place represented by the 3 cylinders will be reduced to 50%.

#### **4.4.3.6 Reconstruction**

- Break up and pulverize rejected soil cement into no larger than 25 mm pieces. Spread the pulverized material for addition of cement.
- Add cement as follows:
  - For a section reprocessed within 24 hours of the original construction, add 50% of the original cement content.
  - For a section reprocessed between 24 and 48 hours following the original construction, add 75% of the original cement content.
  - For a section reprocessed more than 48 hours following the original construction, add 100% of the original cement content.
- Process the new mixture using pulverization equipment, to Section 5.3 - Full Depth Reclaimed Base Course

#### **4.4.3.7 Subsequent Paving**

- If paving of the finished soil cement does not begin within 24 hours after placement then paving must not begin until the soil cement has cured for a minimum of 7 days.
- If the road is required for traffic before paving, cover the surface with sand and open the road to traffic not earlier than 72 hours after soil cement placement. When ready to pave, remove the sand, repair any damage, clean the soil cement surface and apply prime coat.

## 4.5 GEOTEXTILE

### 4.5.1 General

#### 4.5.1.1 Content:

This section includes the supply and installation of both non-woven and woven geotextile at locations shown on the drawings, stated in the Special Provisions or as directed by the consultant

### 4.5.2 Products

#### 4.5.2.1 Materials

- Non-Woven Geotextile includes:
  - Continuous monofilaments or staple fibers;
  - Random fibers that are physically entangled by punching with needles;
  - Random fibers that are pressed together and melted together at the contact points.

The non-woven geotextile fabric shall meet the following requirements:

**Table 4.5.1: Non-Woven Geotextile Fabric Requirements**

Property	ASTM Test	Material Specification <sup>1</sup> Average Roll Value		
		Type A <sup>2</sup>	Type B <sup>3</sup>	Type C <sup>4</sup>
Grab Tensile Strength (N)	D4632	400 min	650 min	875 min
Grab Tensile Elongation (%)	D4532	50% min	50% min	50% min
Mullen Burst (MPa)	D3786	1.2 min	2.1 min	2.7 min
Puncture (N)	D4833	240 min	275 min	550 min
Trapezoidal Tear (N)	D4533	180 min	250 min	350 min
Ultraviolet Stability (% Retained Strength)	D4355	70 % 150 hr	70 % 150 hr	70 % 150 hr
Apparent Opening Size	D4751	0.2 max	0.2 max	0.2 max
Permittivity (per sec)	D4491	2.1 min	2.1 min	2.1 min
Flow Rate (L/sec/m2)	102 min	102 min	102 min	102 min
Minimum fabric lap shall be 300mm				

Note 1: All numeric values except A.O.S. represent minimum average roll value as measured in the weaker principal direction.

Note 2: Typically used with perforated pipe and similar applications;

Note 3: Typically used in medium duty situations such as under rip rap;

Note 4: Typically used in heavy duty situations such as large rip rap.



### 4.5.2.2 Woven Geotextile

Woven Geotextiles consist of continuous monofilaments, staple fibers; multi-filament yarns, or slit films that are woven into a fabric.

Woven geotextiles shall have the following material properties:

**Table 4.5.2: Woven Geotextile Fabric Requirements**

Property	ASTM Test	Material Specification <sup>1</sup> Average Roll Value		
		Class 1	Class 2	Class 3
Elongation (%)	D 4632	<50 min	<50 min	<50 min
Grab Strength (N)	D 4632	1 400 min.	1 100 min.	800 min
Sewn seam strength (N)	D 4632	1 260 min.	990 min.	720 min
Tear Strength (N)	D 4533	500 min. <sup>2</sup>	400 min. <sup>2</sup>	250 min.
Puncture Strength (N)	D 4833	500 min.	400 min.	300 min
Permittivity (per sec)	D 4491	0.05 min. <sup>3</sup>	0.02 min. <sup>3</sup>	0.02 min. <sup>3</sup>
Apparent Opening Size (mm)	D 4751	0.43 max.	0.60 max.	0.60 max.
Ultraviolet stability (% retained strength)	D 4355	50% after 500 hrs of exposure	50% after 500 hrs of exposure	50% after 500 hrs of exposure

Note 1: All numeric values except A.O.S. represent minimum average roll value as measured in the weaker principal direction.

Note 2: For woven monofilament geotextiles, the required minimum average roll value for tear strength is 250 N.

Note 3: Default value. Permittivity of the geotextile should be greater than that of the soil. The Consultant may also require the permeability of the geotextile to be greater than that of the soil.

## 4.5.3 Execution

### 4.5.3.1 Placement

- Unless otherwise directed in the applicable specification, the placement of geotextile shall be in accordance with the following:
- The surface to receive the geotextile shall be prepared to a relatively smooth condition free of obstructions, depressions, debris, and soft or low density pockets of material. The geotextile fabric shall be installed free from tensile stresses, folds, wrinkles, or creases.
- If more than one width of geotextile fabric is used, the Contractor shall either overlap the joints by a minimum of 400 mm with no stitching, or overlap the joint by 200 mm and provide two rows of stitching at each joint.

- The geotextile fabric shall be protected all times during construction. Wheeled or tracked vehicles shall not be allowed to travel directly on the geotextile fabric. Any geotextile fabric damaged during installation or during placement of granular material shall be replaced by the Contractor at his own expense.

## 5. GRANULAR MATERIAL

### 5.1 GRANULAR BASE COURSE

#### 5.1.1 General

##### 5.1.1.1 Content:

This section includes: the spreading and compacting of imported aggregate into a base or sub-base, the scarifying, shaping and compacting of existing granular base or sub-base, and the windrowing of existing gravel, preparing the subgrade and spreading and compacting granular base or sub-base.

##### 5.1.1.2 Related Sections:

- Aggregate Section 2.1
- Grading Section 2.3
- Subgrade Preparation Section 4.1

##### 5.1.1.3 Definition:

**Maximum Density:** The dry unit mass of a sample at optimum moisture content as determined in the laboratory to ASTM D698 Method A.

##### 5.1.1.4 Quality Assurance:

- **Testing Frequency**

The quality assurance laboratory will take a minimum of one field density test on a compacted granular lift for each 1 500 m<sup>2</sup> of road, 1 000 m<sup>2</sup> of alley, or 500 m<sup>2</sup> of walk, monolithic walk, curb ramp, alley crossing, commercial crossing, private crossing, or median or island strip, according to ASTM D1556, ASTM D2167, or ASTM D2922 for comparison with a maximum density determined according to ASTM D698 Method C.

- **Required Density**

The compacted lift thickness of a granular course shall not exceed 150 mm, or as directed by the City. The required density of granular base courses is shown in the following table.

**Table 5.1.1: Granular Base Course Density Requirements**

Compacted Granular Base Course	Required Percentage of Maximum Density
under roads, curb and gutter	100%
under commercial or alley crossings	100%
under asphalt or concrete walk, transit pads	97%
under walk portion of monolithic walk	100%
under curb ramps	100%
under private crossings	97%
under median or island strips	97%
as granular walkways	95%
under shared use paths	100%

## 5.1.2 Products

### 5.1.2.1 Materials

**Granular Materials:** to Section 2.1 Aggregate, Designation 3, classes as indicated on the Drawings.

### 5.1.2.2 Equipment

**Equipment:** Graders, rollers and other equipment of adequate design and capacity to produce a granular base or subbase as specified.

## 5.1.3 Execution

### 5.1.3.1 Preparation

- The prepared subgrade shall be inspected by the City before placing the granular course.
- On existing gravel roads or lanes, clean the surface of clay lumps, vegetation and other deleterious material. To assess the condition of subgrade and depth of gravel, make exploratory cuts along the third points of the road width, or along the centreline of the alley. After assessment, regrade and compact the gravel to prevent ponding water.

### 5.1.3.2 New Granular Base or Subbase Course

- Deposit aggregate and spread uniformly in lifts not exceeding 150 mm thickness when compacted.

- **Segregation:** If segregation occurs:
  - **In Class 20 aggregate:** blade the lift and mix thoroughly before final spreading and shaping to crown and grade.
  - **In Class 63 or Class 80 aggregate:** remove and replace the segregated material.

#### **5.1.3.3 Existing Gravel on Suitable Subgrade**

- If subgrade is found to be acceptable by the City and is on designated grade and if there is sufficient depth of gravel, scarify the existing gravel to 75 mm depth and pulverize material to no larger than 50 mm pieces. Remove rocks larger than 75 mm.
- If there is insufficient depth of gravel and subgrade is on grade, scarify to 50 mm depth, remove rocks larger than 75 mm, pulverize to no larger than 50 mm pieces, add the designated class of imported aggregate and mix thoroughly with existing gravel.
- Spread and shape to crown and grade in lifts not exceeding 150 mm when compacted.

#### **5.1.3.4 Existing Gravel on Subgrade to be Re-worked**

- i. If subgrade is found to be unsuitable or not on designated grade, windrow existing gravel to one half of the road or lane and rework the exposed subgrade as required.
- ii. When directed by the Engineer, excavate and remove unsuitable subgrade soil and backfill with approved material to Section 2.1 - Aggregate.
- iii. Prepare 150 mm subgrade to Section 4.1 - Subgrade Preparation or Section 4.2 - Cement Stabilized Subgrade.
- iv. If subgrade is found to be too low, scarify and blend with approved imported fill and compact in 150 mm lifts to Section 4.1 - Subgrade Preparation or Section 4.2 - Cement Stabilized Subgrade.
- v. If subgrade is found to be too high, remove excess soil, scarify to 150 mm depth and compact to Section 4.1 - Subgrade Preparation or Section 4.2 - Cement Stabilized Subgrade.
- vi. Repeat i-iv on the other half of the road or alley.
- vii. After reworking the subgrade, prepare gravel for compaction to Clause 5.1.3.3.

### 5.1.3.5 Compaction

- Bring the moisture content of the aggregate to near optimum and have the compaction tested within 24 hours of concrete or asphalt placement. Where subgrades/bases are not protected, density tests obtained prior to a rain event are obsolete and the lot must be retested.
- **Non-compliance:** If a density test result is less than the required density, that test result is discarded and 3 retests shall be performed on the area represented by the failed test. The average of the 3 retests shall represent the density of that area. If this average is less than the required density, the area shall be reworked to the full depth of the lift; the aggregate moisture content altered as necessary and re-compacted to the required density. If the area is not retested but is reworked and re-compacted the area shall be tested as per normal testing frequencies.
- The Contractor shall assume the risk of uncovering and reworking the granular base if it is covered before the City has accepted test results thereof.

### 5.1.3.6 Field Quality Control

- Check finished surface of granular base to ensure that it meets the following tolerances:
  - Surface Tolerance: 15 mm maximum variation under 3 m straightedge.
  - Grade Tolerance: 6 mm maximum variation above designated elevation and 15 mm maximum variation below designated elevation.
- When Tolerance Exceeded
  - Trim high spots and refinish surface to within tolerance.
  - Add approved aggregate to low areas, scarify, blend, re-spread and re-compact to required density and refinish surface. Alternatively, compensate low areas with extra thickness of subsequent granular base course.

### 5.1.3.7 Subsequent Paving Course

- Do not permit vehicular traffic on the compacted granular base before paving.
- If the granular base floods, drain immediately by natural flow or by pumping to catch basins, manholes, or ditches.
- Repair any damage, including freezing, to the granular base course and retest for density before paving or concrete pour.

## 5.2 GRANULAR WALKWAY

### 5.2.1 General

#### 5.2.1.1 Content:

This section includes the construction of granular walkway.

#### 5.2.1.2 Related Sections:

- Aggregate Section 2.1
- Grading Section 2.3
- Subgrade Preparation Section 4.1
- Topsoil Section 02910 – Volume 5: Landscaping
- Seed and Sod Section 02920 – Volume 5: Landscaping

### 5.2.2 Products

#### 5.2.2.1 Materials

- Gravel: to Section 2.1 - Aggregate, Designation 3, Class 20A.
- Geotextile: woven fabric, Nilex Type P500 or equivalent.

### 5.2.3 Execution

#### 5.2.3.1 Preparation

- **Clearing:** Clear to a minimum of 1.0 m wider than walkway width and to ensure a minimum vertical clearance of 3.0 m above finished grade.
- **Grading:** Excavate and grade to the required subgrade elevation to Section 2.3 - Grading.
- **Subgrade Compaction:** Prepare and compact the subgrade to a minimum 95% of maximum density to Section 4.1 - Subgrade Preparation. Subgrade must be free of stumps, roots and rocks greater than 100 mm diameter and other deleterious material.
- **Geotextile:** Line the excavation with geotextile fabric. Stretch the fabric taut and free of wrinkles. Ensure fabric completely covers the base and both sides of the excavation. Overlap each new strip of fabric by 500 mm over the previously laid strip. Remove and replace damaged or deteriorated fabric.

### 5.2.3.2 Walk Construction

**Gravel Surfaces:** Spread gravel uniformly on the geotextile and compact to 95% of Standard Proctor Density.

### 5.2.3.3 Workmanship

#### Surface Finish:

- The finished gravel surface shall be smooth and free of loose material and shall conform to the crown or crossfall and longitudinal slope as shown on drawings.
- Trim high spots and refinish surface.
- Add gravel to low areas, scarify, blend, re-spread and re-compact to the required finish.

### 5.2.3.4 Cleanup

- Trim all protruding geotextile level with the graded surface.
- Restore areas disturbed by construction to original condition.
- Rehabilitate disturbed edges with topsoil and seed to Section 02910 – Topsoil and Section 02920 – Seed and Sod in Volume 5: Landscaping.
- Clean up and dispose of all debris and surplus material.



## 5.3 FULL DEPTH RECLAIMED BASE COURSE

### 5.3.1 General

#### 5.3.1.1 Content

This section includes: the pulverization of existing asphalt, soil cement and/or aggregate roadway structures, the addition and mixing of stabilizing agents into the reclaimed base, and the grading and compaction of the reclaimed base course.

#### 5.3.1.2 Related Sections

- Section 2.3 Grading.
- Section 4.2 – Cement Stabilized Subgrade.
- Section 5.1 – Granular Base Courses.

#### 5.3.1.3 Definition

**Reclaimed Base Course:** pulverized and processed roadway structure to the depths shown on the drawings or defined by the Engineer.

#### 5.3.1.4 Quality Assurance

- **Maximum Density:** the dry unit mass of a reclaimed base course sample at optimum moisture content as determined in the laboratory according to ASTM D698 Method A.
- **Required Density:** a minimum of 100% of the maximum density for each 150 mm of reclaimed base course.
- **Testing Frequency:** the quality assurance laboratory will take a minimum of one field density test for each 1 000 m<sup>2</sup> of compacted reclaimed base course according to ASTM D2167 or ASTM D2922 for comparison with a maximum density determined according to ASTM D698 Method A. Where subgrades/bases are not protected, density tests obtained prior to a rain event are obsolete and the lot must be retested.

### 5.3.2 Products

#### 5.3.2.1 Materials

- **Cement:** to CSA A3000, Type GU/GUL/GULb – General use cement
- **In-Situ Materials:** the existing pavement structure to be pulverized has been investigated, and the results are included in the contract Special Provisions. If additional coring or sampling is desired, the coring or sampling shall be at the expense of the Contractor, upon approval of the Engineer.

- **Stabilizing Agents:** fluid chemical or bituminous stabilizing agents as specified in the contract Special Provisions, and as directed by the Engineer
- **Water:** may be obtained from City fire hydrants according to the General Requirements. Other water sources are subject to the Engineer's approval.

#### 5.3.2.2 Equipment

- **Reclaimer/Stabilizer:** a roadway structure pulverizing machine with the following characteristics, and subject to the Engineers approval:
  - The capability of pulverizing asphalt, soil cement and gravel roadway structures to depths of at least 400 mm in a single pass, and accurately maintaining a pre-set depth of cut.
  - A milling drum that rotates upward into the direction of advance with a minimum cut width of 2.0 m.
  - A system to apply and to regulate the addition of water or fluid stabilizing admixtures in relation to the depth of mixing and rate of advance of the machine.
- **Compaction Equipment:** self-propelled vibratory steel drum or sheepfoot/padfoot rollers capable of achieving the required compaction of the reclaimed base course, and providing a surface suitable for the placement of hot-mix asphalt concrete.

### 5.3.3 Execution

#### 5.3.3.1 Preparation

- Roadway areas to be reclaimed will be indicated on plans or designated by the Engineer.
- Ensure that any conflicts with underground utilities in the zone of reclamation are resolved prior to pulverization.

#### 5.3.3.2 Pulverization

- Pulverize the existing roadway structure into fragments no larger than 25 mm maximum dimension, exclusive of existing aggregate.
- Ensure that the reclaimed base course mixture is homogeneous and well graded using additional passes of the reclaimer/stabilizer if required.

### 5.3.3.3 Addition of Stabilizing Admixtures

- Add stabilizing admixtures to the reclaimed base course as shown on the Drawings or as directed by the Engineer.
  - **Cement:** to Section 4.2 – Cement Stabilized Subgrade
  - **Liquid chemical or bituminous stabilizers:** as defined in the contract Special Provisions.
- Ensure that the stabilizing admixtures are uniformly distributed and mixed with the pulverized material.

### 5.3.3.4 Grading and Compaction.

- To Section 2.3 – Grading and Section 5.1 – Granular Base Courses.
- Leave the surface of the compacted reclaimed base course slightly higher than the required elevation; then trim to the design crown and grade. Leave the finished surface even and free of depressions, humps or loose material.

### 5.3.3.5 Field Quality Control

- Check the finished surface of the reclaimed base course to ensure it meets the following tolerances:

Grade: 6 mm maximum variation above design elevation.

25 mm maximum variation below design elevation.

- When Tolerance Exceeded
  - Trim high areas and refinish surface to within tolerance.
  - Add reclaimed base material or approved granular material to low areas, scarify and blend to full reclamation depth, re-compact to required density, and refinish surface.
- **Density Tests:** If a density test result is less than the required density, that test result is discarded and 3 retests shall be performed on the area represented by the failed test. The average of the 3 retests shall represent the density of that area. If this average is less than the required density, the area shall be reworked to the full depth of the lift; the aggregate moisture content altered as necessary and re-compacted to the required density. If the area is not retested but is reworked and re-compacted the area shall be tested at normal testing frequencies.

### **5.3.3.6 Protection of Finished Work**

- Do not permit vehicular traffic over the reclaimed base course until permitted by the Engineer.
- If the reclaimed base course floods, drain immediately by natural flow or by pumping to catch basins, manholes, or ditches.
- Maintain protection of the reclaimed base course until paved with hot-mix asphalt concrete. Repair base course if damaged.

## 6. PAVEMENTS

### 6.1 SGC HOT-MIX ASPHALT CONCRETE

#### 6.1.1 General

##### 6.1.1.1 Content:

This section includes: the production of a hot mixture of asphalt cement, aggregate, and/or other materials, for paving, and the requirements for submittals, materials, mix design, quality control, quality assurance, and mix production.

##### 6.1.1.2 Related Sections

- Section 2.1 – Aggregate
- Section 6.4 – Stone Mastic Asphalt Concrete
- Section 6.3 – SGC Hot-Mix Asphalt Paving
- Section 6.11 – Recycled Asphalt Paving

##### 6.1.1.3 Definitions

- **Asphalt Cement Content:** the amount (percentage) of asphalt cement in the SGC hot-mix, as determined by TSS in Clause 6.1.1.4 Quality Assurance, and is the value upon which any unit price adjustments will be based.
- **10mm – High Traffic (10mm - HT):** mix used primarily for paving residential collector roadways and selected arterial roadways.
- **10mm – Low Traffic (10mm - LT):** mix used for paving local residential roadways and alleyways.
- **20mm - Base (20mm-B):** base course for freeways, arterials, industrial/commercial roadways and collector roadways.
- **Bailey CA-CUW:** Coarse Aggregate (CA) Chosen Unit Weight (CUW) of combined aggregate as defined by the “Bailey Method”.
- **Bailey CA-LUW:** Bailey method CA – Loose Unit Weight (LUW).
- **Bailey CA-RUW:** Bailey method CA – Rodded Unit Weight (RUW).
- **Bailey FA-LUW:** Bailey method Fine Aggregate (FA) – LUW.
- **Bailey FA-RUW:** Bailey method FA – RUW.
- **Bailey Method:** a method of selecting asphalt concrete aggregate proportions, indicated by the most recent edition of “Achieving Volumetrics and HMA Compactability”, as published by the Asphalt Institute and the Heritage Research Group.
- **Bailey Nominal Maximum Aggregate Size (BNMAS):** the first sieve, in the standard sieve series (2.50 mm, 5.0 mm, 10.0 mm, 12.5 mm, 20.0 mm, and 25.0 mm), larger than the first standard sieve to retain more than 15 percent by weight

- **ESS:** The Technical Services Section, Integrated Infrastructure Services of the City of Edmonton (City).
- **Job Mix Formula:** establishes the target combined aggregate gradation, plant settings, approved asphalt cement content to be used for production of the asphalt mix, and the associated production tolerances, based on the submitted SGC mix design and the results of the trial batch of SGC hot-mix, as tested by the TSS, and requires approval of the TSS.
- **SGC Specimens:** Test specimens prepared using the Superpave Gyrotory Compactor (SGC) at a specified number of design gyrations ( $N_{design}$ ) of either 75 or 100. The SGC formed specimens are to be used for the determination of volumetric properties on the laboratory produced SGC hot-mix as outlined in the Asphalt Institute SP-2 Manual.

#### 6.1.1.4 Submittals

- **Asphalt Cement Data**

Submit written certification, with the SGC mix design that the asphalt cement complies with the specifications. This certification shall include, but not be limited to:

- Name of the Supplier.
- Source(s) of the base asphalt cement(s).
- Type and source(s) of admixture(s).
- Proportions of materials used in the asphalt cement.
- Current laboratory test results of the asphalt cement.
- Certification statement from the supplying agency that the asphalt cement is a straight run, non-air blown/oxidized, non-chemically modified asphalt cement and, if the asphalt cement is modified, it has been modified only with a SB-type copolymer and that it complies with the requirements of this specification. **Use of REOB is not accepted.**

Certification shall be submitted (1) for the asphalt cement used in the mix design as part of a submittal, and, (2) at the start of mix production, utilizing the approved job mix formula.

- **SGC Mix Design**

Submit a SGC mix design, carried out by an independent laboratory, to the TSS at least 10 days before the start of any SGC hot-mix production, and for each subsequent change in supplier or source of materials. No SGC hot-mix production can proceed until the applicable mix design and job mix formula is approved by the TSS.

Submit all SGC hot-mix mix design characteristics, including but not limited to:

- Legal description of all aggregate sources;

- Source of RAP;
- Individual aggregate, RAP and mineral filler gradations;
- Individual aggregate one and two crushed face counts;
- RAP aggregate one and two crushed face counts;
- Water absorption of the individual aggregates and the combined aggregates;
- Based on the individual aggregate results the calculated water absorption of the combined aggregates;
- Aggregate blend;
- Combined aggregate gradation;
- Bulk specific gravity of individual aggregates and mineral filler;
- Based on the individual aggregate results, the calculated bulk specific gravity of the combined aggregates;
- Maximum Theoretical Density (MTD) of the RAP;
- Binder content of the RAP, determined by total mix to two significant digits;
- Bulk specific gravity of the RAP binder;
- Bailey CA-RUW for each individual coarse aggregate Stockpile;
- Bailey CA-LUW for each individual coarse aggregate stockpile;
- Bailey FA-RUW for each individual fine aggregate stockpile;
- Bailey FA-LUW for each individual fine aggregate stockpile;
- Virgin asphalt cement bulk specific gravity;
- Mixing and compaction temperature, as determined by the asphalt cement's temperature-viscosity curve, which is to be provided, or as recommended by the asphalt cement supplier;
- Two hour, short-term oven aging temperature;
- Anti-stripping agent supplier, product name, product specification sheet, and application rate;
- Bailey CA-CUW
- Comments on the other Bailey parameters (CA Ratio, FAc Ratio, and FAF Ratio);
- A hard copy of the Bailey spreadsheet with an electronic copy of the Bailey spreadsheet to be e-mailed to the TSS;
- Number of design gyrations (N<sub>design</sub>) in the SGC;
- Number of maximum gyrations (N<sub>maximum</sub>) in the SGC;
- A minimum of five individual and separate asphalt cement contents must be used in the SGC mix design and each individual asphalt cement content must be separated by a minimum of 0.40 to a maximum of 0.60 percent (by dry weight of aggregate);
- Graph of mix's Theoretical Maximum Density (MTD) versus asphalt cement content (by total mix) reported to two significant digits;
- All other graphs used in the mix design (by total mix);
- Individual mix property results are to be plotted and a second order polynomial graph drawn through the individual data points.

- Recommended initial asphalt cement content and associated mix parameters;
- Ratio of virgin asphalt cement content to total asphalt cement content;
- Asphalt cement absorption of the combined aggregates;
- Ignition oven asphalt cement content correction factor;
- Asphalt Pavement Analyzer (APA) result;
- Tensile Strength Ratio (TSR) including the optional freeze-thaw cycle.

The review of the submitted SGC mix design will not begin until all of the information required in Clause 6.1.1.4-SGC Mix Design has been provided.

A previously approved SGC hot-mix mix design, of the required mix type, may be accepted by the City, if the same materials for which the mix design was approved are used and provided that the previously approved job mix formula requirements are satisfied.

- **Plant Scale Certificate**

Provide a copy of the plant scale certificates to the TSS at least 10 days prior to any SGC hot-mix production.

- **Job Mix Formula**

Submit with the SGC hot-mix mix design the proportions of materials and plant settings to be used include the following:

**For Batch Plant:**

- Sieve analysis of combined aggregate in the mix.
- Sieve analysis of aggregate in each bin separation to be used.
- Sieve analysis of RAP if used.
- Mass of material from each bin for each batch of mix.
- Mass of asphalt cement in each batch.
- Mass of anti-stripping agent in each batch
- Mixing temperature of asphalt cement determined from its temperature-viscosity curve, or as recommended by the manufacturer.

**For Continuous or DrumMix Plant:**

- Sieve analysis of each aggregate and mineral filler.
- Sieve analysis of combined aggregate in the mix.
- Sieve analysis of RAP if used.
- Mass of asphalt cement per tonne of mix.
- Mass of anti-stripping agent per tonne of mix.
- Mixing temperature of asphalt cement determined from its temperature-viscosity curve, or as recommended by the manufacturer.



- Settings of aggregate and asphalt cement feed systems (blend).
- **Quality Control Plan**
  - Before commencing SGC hot-mix production, submit a quality control plan to the TSS for review and approval. The quality control plan is to including the following recommended tests and frequency, as a minimum.
  - Submit test results, as requested, to the TSS for review.

**Tests per sample:**

- Mix bulk specific gravity, average of two SGC specimens;
  - Asphalt cement content, Reported to two significant digits;
  - MTD of loose mix;
  - Gradation of the extracted mix;
  - Moisture content of the mix;
  - Air voids by calculation and by MTD;
  - Voids in the mineral aggregate (VMA);
  - Voids filled with asphalt cement;
  - Film thickness calculation;
  - Sample time and location;
  - Plant discharge temperature;
  - Asphalt storage temperature.
- 
- **Frequency:** Minimum of one sample for asphalt cement content and mix gradation per 500 tonnes of mix production, and minimum of two complete test samples per day of production exceeding 500 tonnes per mix type.
  - **Aggregates**
    - Submit LA abrasion, soundness, detrimental matter and Plasticity index test results for each aggregate source for each SGC mix type at least once per year. Submit results of gradation and crushed face count(s) at the following frequencies:
      - For a stockpile existing at the time of contract award: a minimum of one gradation and crushed faces count(s) test per 500 tonnes of aggregate. In addition, submit the average gradation and crush faces count(s) for each entire stockpile when submitting a mix design using aggregate from the stockpile(s).
      - For aggregate stockpiled during the contract: a minimum of one gradation and crushed face count(s) per 500 tonnes of aggregate, or each day's production, whichever is less.

- Submit results to the TSS within 72 hours of the completion of testing. Do not use aggregate until test results have been reviewed and accepted by the Engineer.
- **Quality Assurance**

- **Inspection and Testing**

In addition to field inspections by the Engineer, TSS will conduct plant inspection and materials sampling and testing described in the following paragraphs.

- **Asphalt Plant**

Inspections will be conducted at least once a week during production to check plant calibrations, plant operation, production settings, temperatures, and materials handling. Samples of materials and mixture may be taken and tested.

- **Asphalt Cement**

Quality assurance sampling and testing of the asphalt cement shall be performed by the TSS, to verify compliance to the specification. A sample shall be taken at random during paving operations on City projects from a load(s) delivered to the Contractor's asphalt plant at least twice a month or as otherwise determined by the TSS. It is the contractor's responsibility to inform the TSS of the delivery of asphalt Cement to their facility for sampling.

- If non-complying material is identified, the paving program may be suspended for 24 hours, as directed by the Engineer, during which time the Contractor, the Engineer, and TSS will meet to determine the impact of the non-compliance, and specify the necessary remedial action to be taken by the Contractor. Remedial action shall be either acceptance, acceptance at a pay adjustment, or removal and replacement at no cost to the City. If suspended, the paving program shall only continue upon written authorization by the TSS.
- Asphalt cement identified to be in non-compliance shall not be shipped to a project. SGC hot-mix mixed and placed with identified non-complying asphalt cement shall be removed and replaced, as directed by the Engineer with complying material by the Contractor at no cost to the City.
- Asphalt cement substitution in an approved job mix formula shall not be allowed, without prior approval of the TSS.

- Actual asphalt cement content, in which unit price adjustments will be based on, is defined as the amount of asphalt cement in the mix as determined through the Quality Assurance testing program.
- **Production Mix Analysis**
  - Full mix sample testing will be conducted at a minimum frequency of one test, for each 1,000 tonnes of SGC hot-mix, or a day's production, whichever is less.
  - The mix's asphalt cement content and MTD will be determined at a minimum frequency of one test for every 250 tonnes of SGC hot-mix produced, or a day's production, whichever is less.
  - TSR testing, with the optional freeze-thaw cycle, and APA testing (if required), will be carried out at a minimum frequency of one set per weeks production.
  - The determination of the asphalt cement content will utilize the asphalt ignition oven correction factor, as determined for each SGC hot-mix, by the TSS.
- **Job Mix Formula**

The TSS will test a trial batch of the SGC hot-mix job mix formula to verify the mix design. The mix design and job mix formula will not be approved by the Engineer until successful results are obtained by the TSS.

- **Quality Control**
  - **General**

The Contractor is responsible for quality control throughout all stages of the SGC hot-mix production and placement including the aggregates, asphalt cement, and any other materials used in the mix. The Contractor shall utilize a qualified testing laboratory to undertake the quality control sampling and testing to determine and monitor the properties of the materials being produced and used on the project.

- **Sampling and Testing**

The Contractor shall follow the sampling and testing methods and frequencies indicated in their quality control plan and/or as accepted or modified by ESS.

### 6.1.2 Products

#### 6.1.2.1 Materials

- **Asphalt Cement:** Performance Graded (PG) 58-28, PG 64-28, Polymer Modified PG 76-28 or Polymer Modified PG 70-28 to AASHTO M320, Table 2 which are included in these specification as Table 6.1.8 and Table 6.1.9. For Polymer Modified PG 76-28 and PG 70-28, a straight run, non-chemically modified asphalt cement shall be modified with SB-type copolymers to reach the specified performance grade. No other modifiers are allowed unless approved in writing by the ESS. **The use of REOB is not permitted.**

\*Note: If using PG asphalt cement, PG 58-28 shall be used in 10mm-LT, 10mm-HT and in 20mm-B in all new construction applications and in residential applications, while 10mm-HT, used as overlay on arterial roadways, shall utilize a PG 64-28, or as specified in the contract documents. No modification of the asphalt cement is allowed for the PG58-28 or the 64-28 asphalt cement.

- **Aggregates:** to Section 2.1 – Aggregate and as indicated below.

The SGC hot-mix combined aggregate gradation requirements shall be as follows:

**Table 6.1.1: SGC Hot Mix Aggregate Gradation Requirements**

Designation	1	1	1
Class	10.0	10.0	20
Application	10mm -HT	10mm - LT	20mm - B
Sieve Size (µm)	% Passing by Mass	% Passing by Mass	% Passing by Mass
25 000	100	100	100
20 000	100	100	97 - 100
16 000	100	100	83 – 97
12 500	100	100	70 – 92
10 000	97 - 100	97 - 100	61 - 84
8 000	70 – 94	80 – 94	52 – 77
6 300	45 – 85	65 – 85	44 – 70
5 000	32 – 75	50 – 75	38 – 65
2 500	23 – 55	35 – 55	26 – 52
1 250	16 – 45	25 – 45	18 – 41
630	11 – 36	20 – 36	13 – 31
315	8 – 26	14– 26	9 – 22
160	5 – 15	7 – 15	6 – 14
80	3 - 8	4 - 8	3 – 7

Additional SGC hot-mix aggregate properties shall be as follows:

**Table 6.1.2: Virgin Coarse Aggregate Physical Properties (> 5.0 mm) at the mix design gradation**

Property	Test Method	Requirement
LA Abrasion, % loss, Charge C ( 10mm-LT 7 10mm-HT Charge B (20mm-B)	AASHTO T 96	30.0% Maximum
Soundness (5 Cycles), %loss MgSO <sub>4</sub>	AASHTO T 104	16.0 Maximum
Detrimental Matter, %	Alberta Infrastructure TLT 107	2.0 Maximum

**Table 6.1.3: Virgin Fine Aggregate Physical Properties (< 5.0 mm) at the mix design gradation**

Property	Test Method	Requirement
Soundness (5 Cycles), % loss MgSO <sub>4</sub>	AASHTO T 104	16.0% Maximum
Plasticity Index	AASHTO T 90	Non-Plastic

**Fine Aggregate:** that fraction of the total aggregate passing the 5 000 µm sieve. Fine aggregate shall contain a minimum 75 percent manufactured or crushed fines. The total percent of manufactured fines in a mix is taken as the percentage of manufactured fines in the minus 5 000 µm sieve fraction of the total combined aggregate. When the amount of manufactured fines in the RAP is unknown, it will be assumed that the amount of manufactured fines in the minus 5 000 µm sieve portion is 55 percent for 12.5 mm and 10 mm maximum sized RAP aggregate.

**Crushed-Face Count in Mix:** For each mix type, the minimum percentage, by mass retained down to the 5 000 µm sieve, having at least 2 crushed faces shall be as follows, provided there is a minimum 50% crushed-face count in each individual sieve size greater than 5 000 µm.

**Table 6.1.4: Crushed-Face Count in Mix**

Mix Type:	10mm - HT		10 mm - LT		20mm - B	
Minimum 2 Crushed -Face	90%		85%		90%	
Sieve Fraction (µm)	1 Face	2 Face	1 Face	2 Face	1 Face	2 Face
- 25 000 to + 12 500	-	-	-	-	90	85
- 12 500 to + 10 000	95	90	90	85	95	90
- 10 000 to + 5 000	98	95	93	90	98	95

- **Mineral Filler:** The mineral filler, if required, should consist of limestone dust or approved alternate meeting the requirements of AASHTO M-17 or ASTM D242. The mineral filler must be free from organic impurities and the portion passing the 80 µm sieve size shall have a Plasticity Index of zero.

The mineral filler shall meet the following gradation requirements:

**Table 6.1.5: Mineral Filler Gradation Requirements**

Sieve Size (µm)	Percent Passing (by Mass)
600	100
300	92 - 100
80	60 - 100

**6.1.2.2 Equipment**

- **Asphalt Plant**
  - **Asphalt Mixing Plant:** conforming to ASTM D995, capable of consistently producing a homogeneous mixture in which all aggregate particles are uniformly and thoroughly coated with asphalt cement, heated to the mixing temperature for the grade of asphalt cement, and meeting the following supplementary requirements.
  - Provide free and safe access for the Engineer to verify proportions, settings, and temperatures, and to take samples of asphalt, aggregate, and mixture.
  - All asphalt mixing plants are required to be operated in accordance with the Alberta Environmental Protection Code of Practice. All Contractors operating asphalt plants shall provide proof of registration with Alberta Environmental

Protection and agree that the asphalt plant shall be operated in accordance with the Code of Practice.

- SGC hot-mix production shall not proceed unless all plant scales have been certified by Weights and Measures, Canada Consumer and Corporate Affairs prior to start of construction season and as often as deemed necessary by the Engineer to ensure their accuracy. Plant production shall not proceed until plant calibrations and recalibrations have been reviewed by the Engineer on site. Notify the Engineer at least 24 hours before plant calibrations are made or altered.

### **6.1.2.3 MIX DESIGN**

The mix design for the SGC hot-mix shall be performed by a qualified laboratory following the procedures indicated in “Superpave Mix Design”, as set out in the latest editions of the Asphalt Institute manuals “For Asphalt Concrete and Other Hot-Mix Types” Manual Series No. 2 (MS2), “Superpave Mix Design” Superpave Series No. 2 (SP-2), Section 1.4.2 SGC Mix Design, and to the following criteria.

**Table 6.1.6: Mix Design Requirements**

Mix Type	Requirement		
	10mm - HT	10 mm - LT	20mm - B
<b>Selected Parameters</b>			
Number of Gyration	100	75	100
Gyrations $N_{design}$	160	115	160
Gyrations $N_{maximum}$			
Density at $N_{maximum}$ (% $G_{mm}$ )	98.0 Max	98.0 Max	98.0 Max
Bailey CA-CUW	60 to 85 Max - Fine Graded >95 to 105 Max - Course Graded	60 to 85 Max.	60 to 85 Max.
Air Voids, % of total mix (virgin mix) <sup>1</sup>	4.0 +/- 0.4%	3.0 +/- 0.4%	3.5 +/- 0.4%
Air voids, % of total mix Mix Containing RAS <sup>1,4</sup>	3.5 +/- 0.4%	2.5 +/- 0.4%	3.0 +/- 0.4%
VMA, %	13 Minimum	14 Minimum	12 Minimum
Voids filled, %	70 - 80	73 - 85	65 - 75
Tensile Strength Ratio % (AASHTO T283) <sup>2</sup>	80 Minimum	80 Minimum	80 Minimum
Minimum Film Thickness <sup>3</sup> , mm	7.5 min.	7.5 min.	6.5 min.
APA (mm, 52°C, 8,000 cycles)	5.0 max.	7.0 max.	5.0 max.

Note 1: The mix design air voids shall be selected at the mid point of the specified range or the lowest value within the range in which all the other mix design criterion are met;

Note 2: Minimum Tensile Strength Ratio to be determined in accordance with AASHTO T283, with optional freeze-thaw, at air void content of 7.0+/- 0.5 percent;

Note 3: Minimum film thickness to be determined to Appendix 02066.A

Note 4: If RAS is used in a Recycled Asphalt mix the Air Voids, % of total Mix should be reduced by 0.5% from that used in the virgin mix.

- **Rutting Susceptibility Testing:** SGC hot-mix mix shall be subjected to the APA procedure during the mix design process. APA testing may be carried out by the TSS or the Contractor may use an independent laboratory to perform APA testing. The APA device must meet the requirements of AASHTO T340-10 and must be equipped with an automatic rut measurement system. The APA device must be calibrated at least once per year according to the procedures in the test method. In addition, the load cell used for checking wheel loads shall be calibrated at least once per year. Each test shall have 6 cylindrical samples fabricated and tested with the interior temperature of the APA set at 52°C. The downward force shall be set at 45 Kg and the hoses shall be pressurized to 689 kPa. Each specimen shall be compacted so that 7.0+/- 0.5 percent air voids are achieved. The APA rut test results shall be provided to the nearest 0.1 mm.



Modifications to the SGC hot-mix mix design procedure or criteria are as follows:

- Metric sieves in accordance with CGSB Specification 8-GP-2M shall be used.
- PG asphalt cement content shall be reported based on the total mass of the mix.

- **Job mix Formula**

Do not make changes to the approved job mix formula without written authorization from the ESS. Display the currently approved job mix formula in clear sight of the plant operator.

### 6.1.3 Execution

#### 6.1.3.1 Production of Mix

- **Good Practice Guide**

Refer to the publication TB-1 “Hot Mix Asphalt Materials, Mixture Design and Construction” as prepared by the National Center for Asphalt Technology (NCAT) and published by the National Asphalt Pavement Association (NAPA), for guidance in good practices of handling materials and SGC hot-mix production insofar as consistent with this Section.

- **Production Rate**

Produce SGC hot-mix at a rate compatible with the rate of placement and compaction on the project.

- **Aggregate in Stockpile**

- Stockpile aggregate in horizontal lifts. Stacking conveyors are not allowed for stockpiling. Draw aggregate from stockpile in a manner that mixes the full depth of stockpile face.
- When it is necessary to blend aggregates from one or more sources to produce the combined gradation, stockpile each source or size of aggregate individually. Do not blend aggregates in a stockpile.
- If one or more of the SGC hot-mix properties are not met, the TSS will order suspension of mix production until the Contractor has demonstrated to the ESS's satisfaction that corrective measures have been taken to produce a mix that meets the requirements of this Section.

**Table 6.1.7: Specifications for Premium Grade Asphalt Cements**

TEST CHARACTERISTICS	A.S.T.M. TEST METHOD	Premium Grades of Asphalt Cements					
		150-200 (A)			200-300 (A)		
		Pt.	Abs. Visc.	Pen.	Pt.	Abs. Visc.	Pen.
<b>Absolute Viscosity, 60°C, Pa - s</b>  <b>Penetration, 25°C, 100g, 5s, dmm</b>	D2171	The viscosity and penetration values must fall within the area bounded by A-B-C-D-A plotted as straight lines on a full logarithmic plot (log-log), with the co-ordinates of the points as follows:			The viscosity and penetration values must fall within the area bounded by C-D-E-F-C plotted as straight lines on a full logarithmic plot (log-log), with the co-ordinates of the points as follows:		
	D5	Pt.	Abs. Visc.	Pen.	Pt.	Abs. Visc.	Pen.
		A	155	150	C	50	200
		B	70	150	D	92	200
		C	50	200	E	45	300
	D	92	200	F	26.5	300	
<b>Kinematic Viscosity, 135°C, sq. mm/s</b>  <b>Penetration, 25°C, 100g, 5s, dmm</b>	D2170	The viscosity and penetration values must fall within the area bounded by A-B-C-D-A plotted as straight lines on a full logarithmic plot (log-log), with the co-ordinates of the points as follows:			The viscosity and penetration values must fall within the area bounded by C-D-E-F-C plotted as straight lines on a full logarithmic plot (log-log), with the co-ordinates of the points as follows:		
	D5	Pt.	Kin. Visc.	Pen.	Pt.	Kin. Visc.	Pen.
		A	360	150	C	205	200
		B	225	150	D	285	200
		C	205	200	E	205	300
	D	285	200	F	150	300	
<b>Flash Point, Cleveland Open Cup, °C minimum</b>	D92	205			175		
<b>Solubility in Trichlorethelene, % minimum</b>	D2042	99.5			99.5		
<b>Tests on Residue from Thin Film Oven Test:</b>	D1754	4.0			4.0		
<b>Ratio of Absolute Viscosity of Residue from Thin-Film Oven Test to Original Absolute Viscosity, maximum:</b>	D2171						
<b>Ductility, 25°C, cm, maximum</b>	D113	100			-		
<b>Ductility, 15.6°C, cm, minimum</b>		-			100		

Table 6.1.8: AASHTO M320 Table 2

Performance Grade	PG 46				PG 52				PG 58				PG 64									
	34	40	46	>46	10	16	22	>22	16	22	28	>28	10	16	22	>22	16	22	28	>28		
Average 7-day max pavement design temperature, °C	<46				<52				<58				<64									
Min pavement design temperature, °C	>-34	>-40	>-46	>-46	>-10	>-16	>-22	>-28	>-16	>-22	>-28	>-34	>-10	>-16	>-22	>-28	>-16	>-22	>-28	>-34	>-40	
<b>Original Binder</b>																						
Flash point temp, T 48, min °C	230																					
Viscosity, T 316: <sup>b</sup> Max 3 Pa•sm test temp, °C	135																					
Dynamic shear, T 315: <sup>c</sup> G*/sinδ <sup>d</sup> , min 1.00 kPa test temp @ 10 rad/s, °C	46				52				58				64									
<b>Rolling Thin-Film Oven Residue (T 240)</b>																						
Mass change, <sup>e</sup> max, percent	1.00																					
Dynamic shear, T 315: G*/sinδ <sup>d</sup> , min 2.20 kPa test temp @ 10 rad/s, °C	46				52				58				64									
<b>Pressurized Aging Vessel Residue (R 28)</b>																						
PAV again temperature, °C <sup>d</sup>	90				90				100				100									
Dynamic shear, T 315: G*/sinδ <sup>d</sup> , max 5000 kPa test temp @ 10 rad/s, °C	10	7	4	25	22	19	16	13	10	7	25	22	19	16	13	10	7	25	22	19	16	
Critical low cracking temp, R 49: <sup>f</sup> Critical cracking temp determined by R 49, test temp, °C	-24	-30	-36	0	-6	-12	-18	-24	-30	-36	-6	-12	-18	-24	-30	-36	0	-6	-12	-18	-24	-30

- Notes:
- a. Pavement temperatures are estimated from air temperatures using an algorithm contained in the LTPP Bind program, may be provided by the specifying agency, or by following the procedures as outlined in M 323 and R 35.
  - b. This requirement may be waived at the discretion of the specifying agency if the supplier warrants that the asphalt binder can be adequately pumped and mixed at temperatures that meet all applicable safety standards.
  - c. For quality control of unmodified asphalt binder production, measurement of the viscosity of the original asphalt binder may be used to supplement dynamic shear measurements of G\*/sinδ at test temperatures where the asphalt is a Newtonian fluid.
  - d. G\*/sinδ = high temperature stiffness and G\* sinδ = intermediate temperature stiffness.
  - e. The mass change shall be less than 1.00 percent for either a positive (mass gain) or negative (mass loss) change.
  - f. The PAV aging temperature is based on anticipated climatic conditions and is one of three temperatures, 90°C for climates requiring PG 52-xx and below, 100°C for climates requiring PG 58-xx to PG 70-xx, or 110°C for climates requiring PG 76-xx and above. Normally, the PAV aging temperature is specified based on the PG grade. However, when the binder is being used in a different climate due to grade bumping or needed for softer binder due to blending, the PAV aging temperature may be specified as 100°C when used in climates requiring PG 58-xx to PG 70-xx, or 110°C when used in climates requiring PG 76-xx and above.
  - g. For verification of grade, at a minimum perform T 313 at the test temperature and at the test temperature minus 6°C ant T 314 at the test temperature. Testing at additional temperatures for T 313 may be necessary if 300 MPa is not bracketed at the initial two test temperatures. Compare the failure stress from T 314 to the calculated induced thermal stress per R 49. If the failure stress exceeds the induced thermal stress, the asphalt binder is deemed a "PASS" at the specification temperature.

Table 6.1.9: AASHTO M320 Table 2 (continued)

Performance Grade	PG 70					PG 76					PG 82						
	10	16	22	28	34	40	10	16	22	28	34	40	10	16	22	28	34
Average 7-day max pavement design temperature, °C <sup>a</sup>	<70																
Min pavement design temperature, °C <sup>a</sup>	>-10	>-16	>-22	>-28	>-34	>-40	>-10	>-16	>-22	>-28	>-34	>-40	>-10	>-16	>-22	>-28	>-34
<b>Original Binder</b>																	
Flash point temp, T 48, min °C	230																
Viscosity, T 316: <sup>b</sup> Max 3 Pa•sm test temp, °C	135																
Dynamic shear, T 315: <sup>c</sup> G*/sinδ <sup>d</sup> , min 1.00 kPa test temp @ 10 rad/s, °C	70					76					82						
<b>Rolling Thin-Film Oven Residue (T 240)</b>																	
Mass change, <sup>e</sup> max, percent	1.00																
Dynamic shear, T 315: G*/sinδ <sup>d</sup> , min 2.20 kPa test temp @ 10 rad/s, °C	70					76					82						
<b>Pressurized Aging Vessel Residue (R 28)</b>																	
PAV again temperature, °C <sup>f</sup>	100 (110)					100 (110)					100 (110)						
Dynamic shear, T 315: G*/sinδ <sup>d</sup> , max 5000 kPa test temp @ 10 rad/s, °C	34	31	28	25	22	19	37	34	31	28	25	40	37	34	31	28	28
Critical low cracking temp, R 49: <sup>g</sup> Critical cracking temp determined by R 49, test temp, °C	0	-6	-12	-18	-24	-30	0	-6	-12	-18	-24	0	-6	-12	-18	-24	-24

Notes:

- a. Pavement temperatures are estimated from air temperatures using an algorithm contained in the LTPP Bind program, may be provided by the specifying agency, or by following the procedures as outlined in M 323 and R35.
- b. This requirement may be waived at the discretion of the specifying agency if the supplier warrants that the asphalt binder can be adequately pumped and mixed at temperatures that meet all applicable safety standards.
- c. For quality control of unmodified asphalt binder production, measurement of the viscosity of the original asphalt binder may be used to supplement dynamic shear measurements of G\*/sinδ at test temperatures where the asphalt is a Newtonian fluid.
- d. G\*/sinδ = high temperature stiffness and G\* sinδ = intermediate temperature stiffness.
- e. The mass change shall be less than 1.00 percent for either a positive (mass gain) or negative (mass loss) change.
- f. The PAV aging temperature is based on anticipated climatic conditions and is one of three temperatures, 90°C for climates requiring PG 52-xx and below, 100°C for climates requiring PG 58-xx to PG 70-xx, or 110°C for climates requiring PG 76-xx and above. Normally, the PAV aging temperature is specified based on the PG grade. However, when the binder is being used in a different climate due to grade bumping or needed for softer binder due to blending, the PAV aging temperature may be specified as 100°C when used in climates requiring PG 58-xx to PG70-xx, or 110°C when used in climates requiring PG 76-xx and above.
- g. For verification of grade, at a minimum perform T 313 at the test temperature and at the test temperature minus 6°C and T 314 at the test temperature. Testing at additional temperatures for T 313 may be necessary if 300 MPa is not bracketed at the initial two test temperatures. Compare the failure stress from T 314 to the calculated induced thermal stress per R 49. If the failure stress exceeds the induced thermal stress, the asphalt binder is deemed a "PASS" at the specification temperature.

**APPENDIX A: METHOD FOR DETERMINING FILM THICKNESS****B1 Surface Area Factors ( $S_a$ ):**

Sieve Size ( $\mu\text{m}$ )	Surface Area Factor ( $\text{m}^2/\text{kg}$ )
5000	0.38
2500	0.78
1250	1.55
630	2.90
315	5.60
160	12.20
80	29.00

Determine total surface area as the sum of the surface areas for the seven specified sieve sizes according to the formula:

$$S_a = 0.38 + \frac{\sum (\% \text{ Passing} \times \text{Surface Area Factor})}{100}$$

**B2 Corrected  $S_a$  ( $S_{ac}$ ):**

Correct  $S_a$  for actual Aggregate Bulk Specific Gravity by the formula:

$$S_{ac} = S_a \times (2.650 / \text{Actual Bulk Specific Gravity})$$

**B3 Film Thickness ( $F_t$ ) Calculation:**

$$F_t = 10 \times (P_{ac} - P_{abs}) / S_{ac} \times SG_{ac} \quad \text{in microns (mm)}$$

Where:

- $P_{ac}$  = Percent Asphalt Cement Content by dry mass of Aggregate
- $P_{abs}$  = Percent of Absorbed Asphalt Cement by dry mass of Aggregate
- $S_{ac}$  = Corrected  $S_a$
- $SG_{ac}$  = Specific Gravity Asphalt Cement

## 6.2 STONE MASTIC ASPHALT CONCRETE

### 6.2.1 General

#### 6.2.1.1 Content

This section includes the production of a hot mixture of asphalt binder and aggregate for paving, and the requirements for mix design, quality control, and quality assurance.

#### 6.2.1.2 Related Sections

- Section 2.1 – Aggregate
- Section 6.3 – Stone Mastic Asphalt Paving

#### 6.2.1.3 Definitions

SGC Specimens: Test specimens prepared using the SHRP Gyrotory Compactor (SGC) at the specified number of  $N_{\text{Design}}$  gyrations of 100.

#### 6.2.1.4 Submittals

##### ○ Submittal of Asphalt Cement Data

Submit certified test results in writing with the mix design that the asphalt cement complies with the specifications. This certification shall include, but not be limited to:

- Name of the Supplier
- Source(s) of the Base Asphalt Cement(s)
- Type and Source(s) of admixture(s)
- Proportions of materials
- Laboratory test results of the Asphalt Cement
- Certification statement that the Asphalt Cement complies with the requirements of this specification.

Certification shall be submitted (1) for a binder used in the design of a job mix formula as part of a submittal, and, (2) during the life of an approved job mix formula.

##### ○ Mix Design

- Submit a mix design carried out by an independent laboratory to the Technical Services Section at least 10 days before the start of any SMA production, and for each subsequent change in supplier or source of materials. No hot-mix production can proceed until the applicable mix design and job-mix formula is approved by the Engineer.

- Submit all SMA mix design characteristics, including graphs used in arriving at the final mix design; the bulk specific gravity of individual aggregates and the combined aggregates; individual aggregate and mineral filler gradations and combined aggregate gradations: the graph of maximum specific gravity versus asphalt content; Blends and Job Mix Formula; the asphalt absorption of the combined aggregates and the Tensile Strength Ratio (TSR) as well as results of Asphalt Pavement Analyzer (APA) testing.
- Submit, with the mix design, six 4-litre containers of PMA asphalt binder, and a sufficient quantity of each aggregate component to result in a 100-kg sample of combined aggregate at the design proportions.
- Plant Scale Certificate
- Provide a copy of the plant scale certificates to the Technical Services Section at least 10 days prior to any SMA production.
- **Job Mix Formula**

Submit with the SMA Mix design the proportions of materials and plant settings to include the following.

- For Batch Plant:
  - Sieve analysis of combined aggregate in the mix.
  - Sieve analysis of aggregate in each bin separation to be used.
  - Mass of material from each bin for each batch of mix.
  - Mass of asphalt binder in each batch.
  - Mixing temperature of asphalt binder determined from its temperature-viscosity curve, or as recommended by the manufacturer.
- For Continuous or DrumMix Plant:
  - Sieve analysis of each aggregate and mineral filler.
  - Sieve analysis of combined aggregate in the mix.
  - Mass of asphalt binder per tonne of mix.
  - Mixing temperature of asphalt binder determined from its temperature-viscosity curve, or as recommended by the manufacturer.
  - Settings of aggregate and asphalt binder feed systems (blend).

- **Quality Control Plan**

Before beginning hot-mix production, submit a quality control plan to the Technical Services Section including the following recommended tests and frequency. Submit test results daily to the Engineer for review.

Tests:            2 Superpave Gyratory Compactor (SGC) per test  
Asphalt binder content  
Air voids  
Voids in the mineral aggregate (VMA)  
Voids filled with asphalt binder  
Moisture content of the mix  
Gradation of the mix  
Plant discharge temperature  
Asphalt storage temperature

Frequency:      A minimum of 2 tests per day of production.

- **Aggregates**

Submit abrasion, soundness, flat and elongated, detrimental matter and clay content test results for each aggregate source. Submit results of sieve analysis to ASTM C136, and crushed face count at the following frequencies:

- For a stockpile existing at the time of contract award: a minimum of one sieve test and one crushed face count per 1 000 tonnes of aggregate. In addition, submit the average gradation of an entire stockpile when submitting a mix design using aggregate from the stockpile.
- For aggregate stockpiled during the contract: a minimum of one sieve test and one crushed face count per 1 500 tonnes of aggregate, or each day's production, whichever is less.

Submit results to the Technical Services Section within 24 hours of testing. Do not use aggregate until test results have been reviewed and accepted by the Engineer.

### **6.2.1.5 Quality Assurance**

- **Inspection and Testing**

In addition to field inspections by the Engineer, the quality assurance laboratory will conduct plant inspection and materials sampling and testing described in the following paragraphs.



- **Asphalt Concrete Plant**

Inspections will be conducted at least once a week during production to check plant calibrations, plant operation, production settings, temperatures, and materials handling. Samples of materials and mixture will be taken and tested.

- **Asphalt Cement**

Quality assurance sampling and testing of the asphalt cement shall be performed by the QA, to verify compliance to the specification. A sample shall be taken at random during paving operations on City projects from a load(s) delivered to the Contractor's asphalt plant at least twice a month or as otherwise determined by TSS. It is the contractor's responsibility to inform TSS of the delivery of asphalt Cement to their facility for sampling.

- If non-complying material is identified, the paving program may be suspended for 24 hours, as directed by the Engineer, during which time the Contractor and the Engineer will meet to determine the impact of the non-compliance, and specify the necessary remedial action to be taken by the Contractor. Remedial action shall be either acceptance, or acceptance at a pay adjustment, or removal and replacement at no cost to the City of Edmonton. The paving program may continue upon written authorization by the Engineer.
- Production binder identified to be in non-compliance shall not be shipped to a project. Asphalt concrete batched and placed with non-complying binder shall be removed and replaced, as directed by the Engineer with complying material by the Contractor at no cost to the City of Edmonton.
- Binder substitution in an authorized job mix formula shall not be allowed, without prior approval of the Engineer.
- Actual asphalt cement content, in which unit price adjustments will be based on, is defined as the amount of asphalt cement in the mix as determined through the Quality Assurance testing program.

- **Production Mix Analysis**

Full SGC testing will be conducted at a minimum frequency of one test, with two SGC specimens per test, for each 500 tonnes of hot-mix, or a day's production, whichever is less. Determine the asphalt cement content and the Maximum Theoretical Density (MTD) of SMA at a minimum frequency of one test for every 250 tonnes of hot-mix produced, or a day's production, whichever is less

- **Job Mix Formula**

The quality assurance laboratory will test a trial batch of the job-mix formula to verify the mix design. The mix design and job-mix formula will not be approved until successful results are obtained.

- **Aggregate Gradation Tolerance**

The variation from the approved job-mix aggregate gradation shall not exceed the following limits:

**Table 6.2.1: Aggregate Gradation Tolerance**

Sieve Size (µm)	% Passing by Mass	
	Individual Sample	Average of Last 3 Samples
5 000	± 3.0	± 3.0
1 250	± 3.0	± 2.5
630	± 3.0	± 2.0
315	± 3.0	± 2.0
160	-1.0 to +3.0	-1.0 to +2.0
80	-1.0 to +2.5	-0.5 to +1.0

- **Asphalt Content Tolerance**

The allowable variation from the approved design asphalt content shall be ± 0.2% by mass of mix.

- **Air Void Tolerance**

The allowable variation from the design air voids in the mix shall be ± 0.5%.

- **Mixing Temperature Tolerance**

The allowable variation from the design mixing temperature shall be ± 9 °C.

## 6.2.2 Products

### 6.2.2.1 Materials

- **Polymer Modified Asphalt Cement:** to AASHTO M320, Table 2 (included in this specification as Table 6.2.8), grade PMA PG 76-28, PG 70-28, or as otherwise set forth in the contract documents. For the Polymer Modified PG 76-28 and PG 70-28 Straight asphalt cement shall be modified with SB-type copolymers to reach the specified performance grade. No other modifiers are allowed unless approved in writing by the City of Edmonton
- **Aggregates:** to Section – 2.1 – Aggregates and as shown below.

The Stone Mastic combined aggregate gradation requirements, including the required mineral filler shall be as per Table 6.2.2.

**Table 6.2.2: Stone Mastic Combined Aggregate Gradation Requirements**

Sieve Size (µm)	Percent Passing by Mass
20 000	Minimum 100
16 000	97 - 100
12 500	88 - 100
10 000	30 - 80
6 300	22 - 45
5 000	20 - 35
2 500	16 - 26
1 250	14 - 22
630	13 - 20
315	12 - 18
160	10 - 16
80	10 - 14

Additional Stone Mastic aggregate properties shall be as follows:

**Table 6.2.3: Coarse Aggregate Physical Properties**

Property	Test Method	Requirement
LA Abrasion, % loss Grading B for plus 10 mm material Grading C for minus 10mm material	AASHTO T 96/ ASTM C131	22% Maximum
Flat & Elongated, % 3:1 5:1	ASTM D 4791	20% maximum. 5% Maximum
Absorption, %	AASHTO T 85	2% Maximum.
Soundness (5 Cycles), % Sodium sulfate Magnesium Sulfate	AASHTO T 104	15% Maximum 20% Maximum
Detrimental Matter, %	Alberta Infrastructure TLT 107	2% Maximum
Crushed Face Count, % One Face Two Faces	ASTM D 5821	100% with at least 1 100% with at least 2

**Table 6.2.4: Fine Aggregate Physical Properties**

Property	Test Method	Requirement
Soundness (5 Cycles), % Sodium sulfate Magnesium Sulfate	AASHTO T 104	15% Maximum 20% Maximum
Angularity, %	AASHTO TP 33	45% Minimum
Liquid Limit, %	AASHTO T 89	25% Maximum
Plasticity Index	AASHTO T 90	Non-Plastic

- **Fine Aggregate:** that fraction of the total aggregate passing the 5 000  $\mu\text{m}$  sieve. Fine aggregate shall contain 100% manufactured or crushed fines
- **Mineral Filler:** The mineral filler should consist of Limestone dust or approved alternate meeting the requirements of AASHTO M-17 or ASTM D242. Filler should be free from organic impurities and the portion passing the 80  $\mu\text{m}$  sieve size shall have a Plasticity Index of zero.

The mineral filler shall meet the following gradation requirements:

**Table 6.2.5: Mineral Filler Gradation Requirements**

Sieve size ( $\mu\text{m}$ )	Percent Passing (by Mass)
600	100
300	92-100
80	60-100

- **Stabilizing Agent:** Cellulose fibers shall be added at a rate of approximately 0.3 percent by total mass of mix in order to prevent draindown. The exact cellulose fibre addition rate to be determined by the SMA mix design.

The cellulose fibers shall meet the following requirements:

**Table 6.2.6: Cellulose Fibers Requirements**

Property*	Requirement
<b>Sieve Analysis:</b>	
<b>Method A – Alpine Sieve Analysis</b>	
Fiber Length	6 mm Maximum
Passing 0.150 mm	70 +/- 10 %
<b>Method B – Mesh Screen Analysis</b>	
Fiber Length	6 mm Maximum
Passing 0.850 mm	85 +/- 10 %
Passing 0.425 mm	65 +/- 10 %
Passing 0.160 mm	30 +/- 10%
Ash Content	18 +/- 5% non-volatiles
pH	7.5 +/- 1.0
Oil Absorption	5.0 +/- 1.0 times fiber mass
Moisture Content	Less than 5% (by mass)

\*Note: Test methods in accordance with those outlined in : Fiber Length "Designing Stone Matrix Asphalt Mixtures Volume IV – Mixture Design Method, Construction Guidelines and Quality Control Procedures" report dated July, 1998 and prepared by the National Center for Asphalt Technology (NCAT).

**6.2.2.2 Equipment**

- **Asphalt Plant**
- Asphalt Mixing Plant: conforming to ASTM D995, capable of consistently producing a homogeneous mixture in which all aggregate particles are uniformly and thoroughly coated with asphalt, and meeting the following supplementary requirements:
- Provide free and safe access for the Engineer to verify proportions, settings, and temperatures, and to take samples of asphalt, aggregate and mixture.
- All asphalt-paving plants are required to be operated in accordance with the Alberta Environmental Protection Code of Practice. All contractors operating asphalt plants shall provide proof of registration with Alberta Environmental Protection and agree that the asphalt plant shall be operated in accordance with the Code of Practice.
- Mix Design
- The SMA Mix design shall be performed by an independent laboratory according to the procedures outlined in NCHRP Report 425 "Designing Stone Matrix Asphalt Mixtures for Rut Resistant Pavements – Part 2 Mixture Design Methods, Construction Guidelines and Quality Control/Quality Assurance Procedures" subject to the following parameters:

**Table 6.2.7: Mix Design Requirements**

Selected Parameters	Requirement
<b>Superpave Gyratory Compactor Design (100 Gyration)</b>	
Air Voids, % <sup>1</sup>	3.5% +/- 0.5%
VMA, %	17 Minimum
VCA <sub>mix</sub> , %	Less than VCA <sub>dry</sub>
Tensile Strength Ratio % (AASHTO T283) <sup>2</sup>	75 Minimum
Draindown @ production temperature, %	0.3 Maximum

Note 1: The mix design air voids shall be selected at the mid-point of the specified range or the lowest value within the range in which all the other mix design criterion are met;

Note 2: Minimum Tensile Strength Ratio to be determined in accordance with AASHTO T283, with optional freeze-thaw, at air voids content of 7.0+/- 0.5 percent;

- **Rutting Susceptibility Testing:** SMA shall be subjected to the Asphalt Pavement Analyzer (APA) procedure during the mix design process and will be subjected to testing during actual production of the mixture, as deemed necessary by the Engineer. APA testing will be carried out by the City of Edmonton Quality Assurance laboratory or conversely the contractor may use an independent certified laboratory to perform APA testing. The APA device must meet the requirements of AASHTO T 340-10 and must be equipped with an automatic rut measurement system. The APA device must be calibrated at least once per year according to the procedures in the test method and a certificate of calibration must be submitted with test results. In addition, the load cell used for checking wheel loads shall be calibrated at least once per year. Each test shall have 6 cylindrical samples fabricated and tested with the interior temperature of the APA set at 52° C. The downward force shall be set at 45 Kg and the hoses shall be pressurized to 689 kPa. Each specimen shall be compacted so that 7+/- 0.5 percent air voids are achieved. The APA rut test results shall be provided to the nearest 0.1 mm. The average rut depth for the specimens tested shall not exceed 5.0mm.
- Modifications to the Stone Mastic mix design procedure or criteria are as follows:
  - Metric sieves in accordance with CGSB Specification 8-GP-2M shall be used in place of the sieves specified in the Asphalt Institute Manual.
  - PG Asphalt Cement content shall be reported based on the total mass of the mix
  - Fine aggregate angularity criteria shall be as defined in Clause 6.2.2.1 – Table 6.2.3.
  - The Alberta Transportation and Utilities ATT and TLT test procedures shall be used to determine fine aggregate angularity.

- **JobMix Formula**

Do not make changes to the approved jobmix formula without written approval from the Engineer. Display the currently approved jobmix formula in clear sight of the plant operator.

### **6.2.3 Execution**

#### **6.2.3.1 Production of Mix**

- **Good Practice Guide**

Refer to the Quality Improvement Series 122 “Designing and Constructing SMA Mixtures – State of the Art Practice” as published by The National Asphalt Pavement Association (NAPA), for guidance in good practices of handling materials and hot-mix production insofar as consistent with this Section.

- **Production Rate**

Produce hot-mix at a rate compatible with the rate of placement and compaction on the job.

#### **6.2.3.2 Aggregate in Stockpile**

- Stockpile aggregate in horizontal lifts. Stacking conveyors are not allowed for stockpiling. Draw aggregate from stockpile in a manner that mixes the full depth of stockpile face.
- When it is necessary to blend aggregates from one or more sources to produce the combined gradation, stockpile each source or size of aggregate individually. Do not blend aggregates in a stockpile.
- If one or more of the mix properties are not met, the Engineer will order suspension of mix production until the Contractor has demonstrated to the Engineer's satisfaction that corrective measures have been taken to produce a mix that meets the requirements of this section.

## 6.3 SGC HOT-MIX ASPHALT PAVING

### 6.3.1 General

#### 6.3.1.1 Content:

This section includes the supply and placement of SGC hot-mix asphalt concrete for roadway paving.

#### 6.3.1.2 Related Sections:

- Section 6.1 – SGC Hot-Mix Asphalt Concrete
- Section 6.6 Pavement Cold Milling
- Section 6.7 Liquid Asphalt Coats

#### 6.3.1.3 Definitions

- **QA:** A Certified Quality Assurance Laboratory or TSS – Technical Services Section, Integrated Infrastructure Services – City of Edmonton.
- **Overlay:** paving over an existing pavement for rehabilitation purposes and not as part of staged paving.
- **Staged Paving:** paving where a lift or lifts that form part of the total pavement structure are deferred to a future date.
- **SGC Density:** the Superpave Gyrotory Compactor (SGC) shall be used to prepare laboratory formed specimens at Ndesign of either 75 or 100 gyrations. The SGC formed specimens shall be used for the determination of volumetric properties on a field produced SGC hot-mix as outlined in the Asphalt Institute SP-2 Manual.

#### 6.3.1.4 Quality Assurance

- **Thickness Cores**

##### QA will:

- i. Take a minimum of one core per 1,000 m<sup>2</sup> of SGC hot-mix asphalt pavement and determine the thickness of the mat, for each stage of paving.
- ii. For a staged paving project, a thickness deficiency at the completion of the first stage of paving may be accepted by the City provided the deficiency is less than 12mm and the deficient thickness can be included in the subsequent stage of paving.
- iii. For non-staged paving projects the thickness tolerances as per Table 6.3.5 shall apply.



- iv. If the initial core thickness is deficient at the completion of the final lift of paving, that initial thickness is discarded, and 3 new cores will be taken within 10 m of the original core location at a minimum spacing of 2.5 m between cores. The average thickness of the 3 new cores represents that area.
  - Asphalt Cement Content and Density Specimen Sampling and Testing

**QA will:**

- i. Determine the Maximum Theoretical Density (MTD) and asphalt cement content of the SGC hot-mix at a minimum frequency of one test for every 250 tonnes of SGC hot-mix produced, or a day's production, whichever is less.
- ii. Obtain one core from compacted mat placed from same load of SGC hot-mix from which SGC specimens were obtained, or from suspect compacted mat, and test for density. Where specified in the special provisions of the contract obtain a second core from the compacted mat for rut testing in the Asphalt Pavement Analyzer (APA).
- iii. Obtain one core from compacted mat representing 1,000 m<sup>2</sup> and test for density.
- iv. Basis of Acceptance: SGC hot-mix pavement compaction will be accepted based on the ratio (in percent) of the core density to the MTD. If cores were taken from a mat where no MTD are available, acceptance will be based on the ratio of core density to the average MTD for that day's production.
- v. Representative Cores: A single core is initially taken representing the quantity of SGC hot-mix in not more than 1,000 m<sup>2</sup> of mat, with a minimum of one core taken from a day's production. If the initial core density is below specified, that initial density is discarded, and 3 new cores will be taken within 10 m of the original core location at a minimum spacing of 2.5 m between cores. The average density of the 3 new cores represents that area.
  - Rutting Susceptibility Specimen Sampling and Testing (Where Specified)

**QA will:**

- i. Where specified, determine the rutting susceptibility of laboratory SGC hot-mix specimens at a minimum frequency of one test for every 5,000 tonnes of SGC hot-mix produced, for an individual project by subjecting the SGC hot-mix specimens to the APA procedure. The APA device will meet the requirements of AASHTO TP63-03 and is equipped with an automatic rut measurement system. The APA device will be calibrated at least once per year according to the procedures in the test method. In addition, the load cell used for checking wheel loads will be calibrated at least once per year. Each test shall have 6 cylindrical samples fabricated and tested with the interior temperature of the APA set at 52°C. The downward force shall be set at 45 Kg and the hoses shall be pressurized to 689 kPa. Each

specimen shall be compacted so that 7.0+/- 0.5 percent air voids are achieved. The APA rut test results shall be provided to the nearest 0.1 mm

- ii. Where specified, determine the rutting susceptibility of SGC hot-mix field core specimens taken at the location of the SGC hot-mix samples by subjecting the field core specimens to the APA procedure as described in the above section. The average rut depth for the specimens tested shall not exceed the specified APA requirements for the mix type. If the initial APA rutting is above specified, that initial APA result is discarded, and 6 new cores will be taken within 10 m of the original core location at a minimum spacing of 2.5 m between cores. The average APA result of the 6 new cores will be taken as to represent that area.
- Tensile Strength Ratio (TSR) Specimen Sampling and Testing (Capital Program)

QA will:

Determine the TSR of SGC hot-mix field samples at a minimum frequency of one test for every 5,000 tonnes of SGC hot-mix produced, for an individual project, in accordance with AASHTO T283, including the optional freeze-thaw cycle.

### **6.3.2 Products**

#### **6.3.2.1 Materials**

- **SGC Hot-Mix Asphalt Concrete**

To Section 6.1 – SGC Hot-Mix Asphalt Concrete.

- **Tack Coat**

To Section 6.7 Liquid Asphalt Coats

#### **6.3.2.2 Equipment**

- **Trucks for Transporting Mix:**

Trucks shall be compatible with size and capacity of the paver; with clean, tight, smooth-sided boxes equipped with waterproof tarpaulins of sufficient size to securely cover all material when boxes are fully loaded. The side of the truck box shall have a 12-mm diameter hole 300 mm from bottom for checking mix temperature. Use only approved release agents, such as water based liquid soap, dry soap powder or approved material and drain all excess release agents from truck beds prior to loading SGC hot-mix. Petroleum derivatives are not permitted as release agents.

- **Paver:**

Pavers shall be self-propelled; with automatic screed controls to maintain grade from a reference string line or ski and to control crossfall, smoothness and joint matching; with vibratory screed equipped with vibratory extensions and augers capable of uniformly spreading the mixture to specified widths and depths without segregation or tearing. Follow the manufacturer's recommended operating procedures.

- **Rollers:**

Shall be self-propelled, reversible; static, oscillating or vibratory steel-drum or pneumatic-tired rollers; with wetting and scraping devices to prevent adhesion of mix to drums or tires (petroleum derivatives are not permitted for cleaning); capable of attaining required density and smoothness; and pneumatic-tired rollers to be equipped with wind skirts. Follow the manufacturer's recommended operating procedures.

- **Hand Tools:**

Rakes, lutes, tampers, straightedges, levels, and other hand tools as necessary to complete the work shall be available.

### 6.3.3 Execution

#### 6.3.3.1 Good Paving Practice

- Production, Placement, Compaction and Quality Assurance of the SGC hot-mix mix should be pursuant to the requirements of TB-1 "Hot Mix Asphalt Materials, Mixture Design and Construction" as prepared by the National Centre for Asphalt Technology (NCAT) and published by the National Asphalt Pavement Association (NAPA), for guidance in good practices of handling materials and hot-mix production insofar as consistent with this Section.
- Refer to the latest edition of the "*Construction of Hot Mix Asphalt Pavements*", Asphalt Institute Manual Series No. 22 (MS22), for guidance in good paving practice insofar as consistent with this Section.
- Provide an experienced foreman who shall be in full time attendance on the paving site to take charge of the entire paving operation from transporting of the mix to final rolling.

#### 6.3.3.2 Preparation

- The Engineer will inspect the existing pavement, base, or subbase before SGC hot-mix paving. The Contractor shall repair imperfections and clean up as directed by the Engineer. Surface shall be true to line and grade within tolerance, firm, dry, and free of loose and deleterious material.

- For new construction or as directed by the Engineer all Catch basins, manholes, water valves, and other fixtures shall be brought to proper grade before final lift paving. Provide temporary protection where necessary until completion of paving. If catch basins, manholes, water valves, and other fixtures are not raised prior to final lift paving as required and are required to be raised subsequent to final lift paving a \$2,000.00 penalty per occurrence, as documented by the Engineer, will be assessed.

- **Multiple Lift Paving**

Apply tack coat to the previous lift before placing a lift, unless permitted otherwise by the Engineer. Clean the exposed surface before tacking.

- Preparation for Overlay or for Succeeding Stage Paving
  - **Sweeping and Cleaning:** Sweep the existing pavement surface with an approved mechanical sweeper. Remove all residual debris and accumulations of deleterious material.
  - **Surface Milling:** If specified, grind the existing surface to specified depth according to Section 6.6– Pavement Cold Milling
  - **Tack Coat:** When the existing surface has passed inspection by the Engineer, apply tack coat to Section 6.7 Liquid Asphalt Coats.
  - Apply tack coat to surfaces intended to be in contact with SGC hot-mix, including the sides of gutters, catch basins, manholes, and other concrete and metal fixtures. Before placing SGC hot-mix, let tack coat completely cure and have tacked surfaces inspected by the Engineer
  - **Asphalt Levelling Course:** The Engineer will designate those areas having 20 mm or greater depressions for levelling course application. Spread the levelling course of SGC hot-mix with a paver one lift at a time, not exceeding 60 mm compacted thickness, and compact to required density.

### 6.3.3.3 Weather Limitations

- No paving is permitted when rain or snow is imminent, or when the surface or base to be paved is wet, icy, snow-covered, or frozen, unless waived by the Engineer.
- No paving is permitted when air temperature and wind speed conditions are below the applicable mat curve in Chart 6.3.1, unless waived by the Engineer.

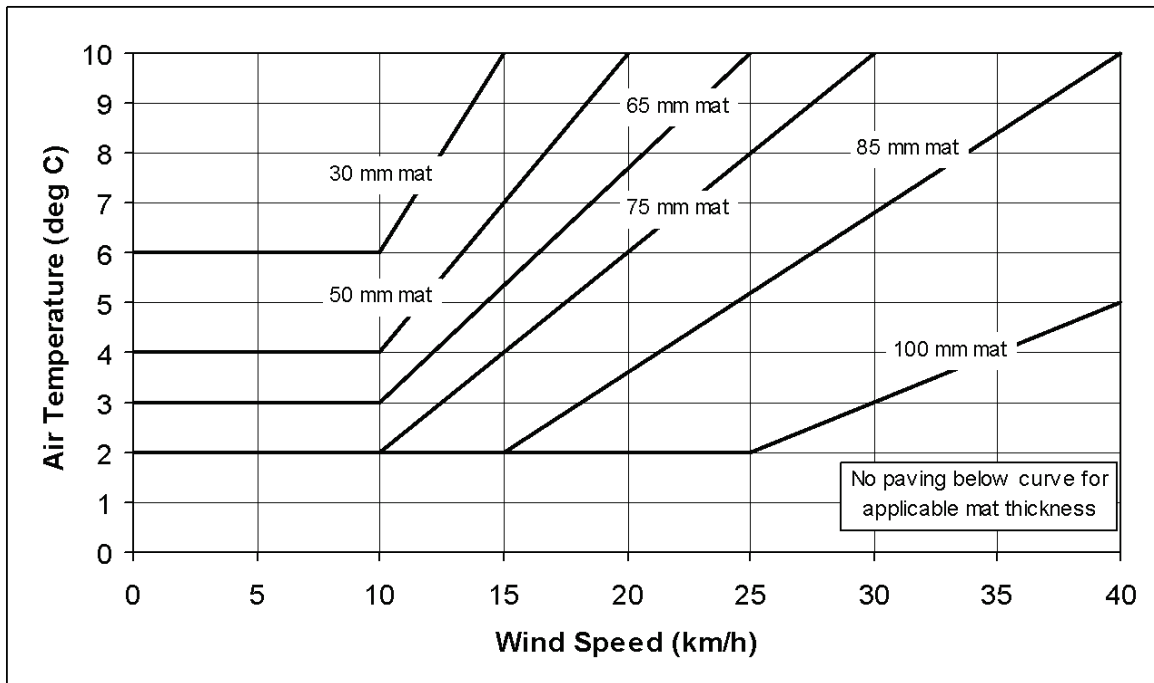
**Chart 6.3.1: Air Temperature and Wind Limitations on Paving**

#### 6.3.3.4 Transportation of SGC Hot-Mix

- Transport the SGC hot-mix in approved trucks with protective covers properly secured to the sides and back of truck box so that no funnelling air movement develops under the cover during hauling.
- Before loading with SGC hot-mix, thoroughly clean the box of any accumulation of asphaltic material. Lubricate inside surfaces with a light coating of soap, detergent solution or an approved release agent. Petroleum derivatives are not permitted.
- Maintain trucks clean of mud and other material that could contaminate the paving area.
- Discharge SGC hot-mix into the paver hopper without spilling and without the truck box bearing down on the hopper.
- If the unit for payment is tonnes, no payment will be made for SGC hot-mix tonnage unless the Engineer is provided with a copy of the corresponding asphalt mix load ticket immediately upon arrival at the site.

#### 6.3.3.5 Spreading

- Placing the SGC hot-mix shall be a continuous operation with the paver moving at a uniform speed compatible with the rate of compaction rolling and SGC hot-mix mix delivery.

- **Spreading of Mix**
  - Ensure that mix compaction temperature meets the asphalt cement manufacturer's requirements, as measured in the mat, immediately behind the paver.
  - Spread the SGC hot-mix uniformly in one or more lifts, or as directed by the Engineer, to depths sufficient to obtain a minimum compacted thickness of 30 mm for 10mm-LT and 10mm-HT mixes and 45 mm for 20mm-B mixes and a maximum compacted thickness of 75 mm for 10mm-LT and 10mm-HT mixes and 100 mm for 20mm-B mixes.
  - Excess SGC hot-mix is to be wasted. Do not pick up any SGC hot-mix materials that has been placed through a paver and put back into the paver hopper. Placing of any excess paver laid SGC hot-mix back into the paver hopper will be assessed a \$500.00 penalty per occurrence, as documented by the Engineer.
- **Segregation**
  - If segregation of mix material occurs, the Engineer will immediately suspend spreading until the cause is determined and corrected.
  - Prior to roller compaction, remove fat spots, sandy accumulations, high and low spots, and other irregularities and repair with SGC hot-mix. Scratch surface with rake tines to ensure bonding of added mix. Do not spread loose SGC hot-mix that has been raked off onto the mat.

#### **6.3.3.6 Hand Spreading**

- Hand spread SGC hot-mix in small areas not accessible to paver, and where permitted by the Engineer.
- Do not broadcast SGC hot-mix. Hand place mix carefully to avoid the segregation of coarse and fine aggregate. Use lutes and rakes to thoroughly loosen and uniformly distribute the SGC hot-mix. Remove lumps that do not break down readily.
- Heat hand tools to prevent asphalt sticking. Do not overheat tools to prevent damaging of the SGC hot-mix.
- Before rolling, check surface with template or straightedge, and correct irregularities.

#### **6.3.3.7 Compaction**

- Compact the SGC hot-mix mat with rollers in good working order and operated by competent operators. Use the number, type, and mass of rollers required to obtain the required compaction within the available compaction time and compatible with the rate of SGC hot-mix placement.

- Develop and follow the best pattern of rolling to obtain the uniform compaction across the mat including joints and edges without degrading the aggregate through over compaction. Indicate the rolling pattern to the Engineer when requested.
- Perform compaction rolling with rollers following the paver as closely as possible, until required density is obtained. Perform finish rolling to eliminate equipment marks and to create a surface with a uniform tightly knit texture.
- Complete final rolling before the mat surface temperature reaches 40°C as determined with an infrared thermometer. If a second lift of asphalt is required the surface temperature of the first lift should be no more than 30°C at the time of placement of the second lift.
- For small areas inaccessible to rollers, use an approved vibratory plate compactor or hand tamper to thoroughly compact the SGC hot-mix.
- If compaction or finish rolling difficulties occur, suspend paving operations, redesign the mix and obtain Engineer's approval of a trial batch before resuming paving.

#### **6.3.3.8 Joints**

- Transverse Joint
  - Plan length of spread to provide for a minimum 1 m offset of transverse joints in successive lifts and adjacent mats.
  - Transverse joints shall be straight, have a vertical face painted with tack coat before placement of the adjacent mat, be thoroughly compacted, and meet surface tolerances.
- Longitudinal Joint
  - Location: Plan mat limits to ensure that surface longitudinal joints will be offset not more than 150 mm from the centre of a proposed pavement marking line between travel lanes. If permitted by the Engineer, the joint may be located at the centre of a travel lane.
  - Plan width of spread to provide for a minimum 150 mm offset (in a dovetail pattern) of longitudinal joints in successive lifts.
  - Create a longitudinal joint while the temperature at the edge of the first of two adjacent mats is above 80°C. Allow an overlap of 25 to 50 mm between mats. This may be accomplished by multiple pavers in staggered formation, or by limiting paver advance.

- Do not roll the 150 mm wide strip along edge of first mat until the adjacent mat is placed. Roll the joined mat immediately to insure bonding while the mix at the joint is about 80°C.
- If a hot longitudinal joint as described in above cannot be created, then carefully roll the edge of the first mat, form or cut a clean vertical face 150 mm back from the mat edge and to the full depth of the mat, and paint with tack coat before placing the adjacent mat.
- Should the longitudinal joint treatment indicated in above not be performed where required, the area of asphalt pavement will be assessed a pay factor of 95 percent. This pay factor will be applied to the price of the total quantity of asphalt placed in the mat area
- The finished longitudinal joint shall be thoroughly compacted and shall meet surface tolerances.

### 6.3.3.9 Mix Production and Paving Tolerances

#### ○ Aggregate Gradation Tolerance

The variation from the approved job-mix aggregate gradation shall not exceed the following limits:

**Table 6.3.1: Aggregate Gradation Tolerance**

Sieve Size (µm)	% Passing by Mass	
	Individual Sample	Average of Last 3 Samples
20 000	± 2.0	± 1.0
16 000	± 3.0	± 1.0
12 500	± 4.0	± 2.0
10 000	± 5.0	± 3.0
8 000	± 4.0	± 3.0
6 300	± 4.0	± 3.0
5 000	± 3.0	± 3.0
2500	± 3.0	± 2.5
1250	± 3.0	± 2.5
630	± 3.0	± 2.0
315	± 3.0	± 2.0
160	-3.0 to +1.0	-2.0 to +1.0
80	-2.5 to +1.0	-1.0 to +0.5



- **Asphalt Content Field Mix Tolerance:** Allowable variation from approved design asphalt content shall be  $\pm 0.3$  percent by mass of mix.
- **Tolerance for Air Voids in Field Mix:**

**Table 6.3.2: Tolerance for Air Voids in Field Mix**

Mix Type:	10mm - HT	10mm - LT	20mm - B
Air Voids, %:	4.0 $\pm$ 0.5	3.0 $\pm$ 0.5	3.5 $\pm$ 0.5

- **Minimum Film Thickness in Field Mix:**

**Table 6.3.3: Minimum Film Thickness in Field Mix**

Mix Type:	10mm - HT	10mm - LT	20mm - B
Min Film Thickness, $\mu\text{m}$ :	7.5 min.	7.5 min.	6.5 min.

- **Voids Filled in field Mix:**

**Table 6.3.4: Voids in Field Mix**

Mix Type:	10mm - HT	10mm - LT	20mm - B
Voids Filled, %:	70 - 80	73 - 85	65 - 75

- **Mixing Temperature Tolerance:**

The allowable variation from the design mixing temperature shall be  $\pm 10^\circ\text{C}$ .

- **Mixture Handling Tolerance:**

In accordance with Section 6.3.3.5; \$500.00 penalty per documented occurrence.

- **Smoothness Tolerances:**

Maximum variation under 3 m straightedge as follows:

- Longitudinal (in the direction of travel): 3 mm.
- Transverse (across the direction of travel): 6 mm.  
(straight crossfall)

- **Grade:** ±6 mm maximum variation from designated grade elevations.
- **Texture:** Finished surface shall be free of visible signs of poor workmanship such as, but not limited to:
  - Segregation, as demonstrated through sandy spots or excessively open spots (areas of water bleeding from the mat),
  - Areas exhibiting excess or insufficient asphalt cement, as demonstrate through fat spots or open textured spots,
  - Improper matching of longitudinal and transverse joints,
  - Dimpling, roller marks, cracking, or tearing.

If surface and grade tolerances are exceeded, or if surface texture is not met, grind down and resurface defective areas as directed by the Engineer.

- **Thickness Tolerance:**
  - **Deficient Thickness:** If average core thickness is deficient that area of asphalt pavement will be assessed a pay factor according to Table 6.3.5 to be applied to the price of the quantity of SGC hot-mix in that mat area.
  - **Excess Thickness:** Asphalt pavement with excess thickness may be accepted with no extra payment, if surface and grade tolerances and texture are met.

**Table 6.3.5: Asphalt Thickness Pay Factors**

THICKNESS DEFICIENCY (%)	PAY FACTOR (%)
10.0	100.0
11.0	97.0
12.0	93.7
13.0	90.0
14.0	85.5
15.0	80.5
16.0	75.0
17.0	68.0
18.0	60.0
19.0	50.0
Over 19.0 %	Grind and Resurface

- **Density Tolerance**

**Required Density:** Each mat of hot-mix placed shall be compacted to the following minimum density (Percent of Maximum Theoretical Density (MTD)) for the type of paving, or as indicated in the contract Special Provisions.

**Table 6.3.6: Density Requirements**

Minimum Density	Type of Paving
94%	All stages in staged paving for freeways, arterials, industrial/commercial roadways and residential collector roadways, and residential local roadways including FAC Overlays
94%	Paving on FDR locations where 10mm-HT is utilized
93%	Alley paving.
93%	Paving on FDR locations where 10mm-LT is utilized
93%	Rehabilitation overlay (mill and overlay locations)
93%	Asphalt walk/bikeway.

- **Deficient Density:** If the average core density is below specified, the represented area of mat may be accepted subject to a pay factor according to Table 6.3.7 to be applied to the price of the quantity of SGC hot-mix in that mat area.

**Table 6.3.7: Asphalt Density Pay Factors**

Percentage of MTD 94% MTD Required	Pay Factor (%)	Percentage of MTD 93% MTD Required	Pay Factor (%)
94.0	100.0	93.0	100.0
93.9	99.9	92.9	98.4
93.8	99.8	92.8	96.8
93.7	99.6	92.7	95.2
93.6	99.4	92.6	93.9
93.5	99.1	92.5	92.0
93.4	98.7	92.4	90.4
93.3	98.3	92.3	88.8
93.2	97.8	92.2	87.3
93.1	97.2	92.1	85.7
93.0	96.5	92.0	84.1
92.9	95.8	91.9	82.5
92.8	95.0	91.8	80.9
92.7	94.2	91.7	79.3
92.6	93.3	91.6	77.7
92.5	92.3	less than or equal to 91.5	Grind and Resurface
92.4	91.1		
92.3	89.8		
92.2	88.5		
92.1	87.1		
92.0	85.5		
91.9	83.8		
91.8	82.0		
91.7	80.0		
91.6	77.7		
less than or equal to 91.5	Grind and Resurface		

○ **APA Tolerance (Where Required)**

Maximum APA rutting: If average core APA rutting is above 5.0 mm for 10mm-HT and 20mm-B and 7.0 mm for 10mm-LT, that area of asphalt pavement will be assessed a pay factor according to Table 6.3.8 to be applied to the price of the quantity of SGC hot-mix in that mat area.

**Table 6.3.8: APA Rutting Pay Factors**

10mm - HT & 20mm - B, APA RUTTING MEASUREMENT (mm)	10 mm - LT, APA RUTTING MEASUREMENT (mm)	PAY FACTOR (%)
5.0	7.0	100.0
5.2	7.2	95.0
5.4	7.4	90.0
5.6	7.6	85.0
5.8	7.8	80.0
6.0	8.0	75.0
6.2	8.2	70.0
6.4	8.4	65.0
6.6	8.6	60.0
6.8	8.8	55.0
Over 7.0 mm	Over 9.0 mm	Grind and Resurface

- **Asphalt Cement Content Tolerance**

- The allowable variation from the approved design asphalt content shall be  $\pm 0.30$  Percent by mass of mix.
- **Deficient Asphalt Cement Content:** If the asphalt cement content, as determined by TSS indicates low or high asphalt cement content, the represented area of mat may be accepted subject to a pay factor according to Table 6.3.9 and is to be applied to the unit price of the 250 tonnes or equivalent area of hot-mix in the mat.

**Table 6.3.9: Asphalt Cement Content Pay Factor**

ESS Asphalt Cement Content (%)	PAY FACTOR (%)
$\pm 0.00 - 0.30$	100.0
$\pm 0.31 - 0.35$	94.0
$\pm 0.36 - 0.40$	90.0
$\pm 0.41 - 0.45$	86.0
$\pm 0.46 - 0.50$	78.0
$\pm 0.51$	Grind and Resurface

- **Asphalt Cement Content Appeal Mechanism (Capital Projects)**

In the event of a Deficient Asphalt Cement Content result the following Asphalt Cement Content Appeal Mechanism will be allowed by the City of Edmonton:

- i. The original core location shall be confirmed by the TSS;
- ii. The TSS will then re-core for determination of asphalt cement content. The re-coring (which may require multiple cores to obtain the required quantity of materials for a re-test) will be taken from the mat representing the original test within 10 meters on either side of the original test location. Only a single test is required for verification process. All core holes to be filled with hot-mix asphalt, by the Contractor, to the satisfaction of the Engineer.
- iii. The asphalt cement content test result from the re-core will supersede the original QA result.
- iv. If the asphalt cement content of the re-core is within the penalty range the penalty will be calculated in accordance with Table 6.3.9 Asphalt Cement Pay Factors for the quantity of asphalt represented by the test. No further re-coring is allowed.
- v. If the asphalt cement content of the re-core is in the “remove and replace” range, additional cores will be taken at equal distances on either side of the original core and tested for asphalt cement content. This process is to be repeated until locations on either side of the re-core identify asphalt within specification. The spacing is at the discretion of the contractor.
- vi. Once the area of asphalt to be removed and replaced” is identified, the area inclusive of the last core used to delineate the deficient area shall be removed and replaced to the satisfaction of the Engineer.

- **Asphalt Cement Content Appeal Mechanism (Private Development):**

In the event of a Deficient Asphalt Cement Content result the following Asphalt Cement Content Appeal Mechanism will be allowed by the City of Edmonton and shall be paid for by the Contractor:

- i. The original core location shall be confirmed by Engineer, the Quality Assurance agency and the City Inspector;
- ii. The Contractor will then be allowed to re-core for determination of asphalt cement content. The re-coring (which may require multiple cores to obtain the required quantity of materials for a re-test) will be taken from the mat representing the original test within 10 meters on either side of the original test location. Only a single test is required for verification process. All core holes to

be filled with hot-mix asphalt, by the contractor, to the satisfaction of the Engineer.

- iii. The asphalt cement content test result from the re-core, along with the original test result, shall be submitted to the City of Edmonton for review. The result from the asphalt cement content test from the re-core will supersede the original QA result.
- iv. If the asphalt cement content of the re-core is within the penalty range the penalty will be calculated in accordance with Table 6.3.9 Asphalt Cement Pay Factors for the quantity of asphalt represented by the test. No further re-coring is allowed.
- v. If the asphalt cement content of the re-core is in the “remove and replace” range, additional cores will be taken at equal distances on either side of the original core and tested for asphalt cement content. This process is to be repeated until locations on either side of the re-core identify asphalt within specification. The spacing is at the discretion of the contractor.
- vi. Once the area of asphalt to be removed and replaced” is identified, the area inclusive of the last core used to delineate the deficient area shall be removed and replaced to the satisfaction of the Engineer.

○ **TSR Tolerance**

**Deficient TSR (Capitol Program):** If the TSR result, as determined by ESS, of field samples is below 80.0 percent (for laboratory prepared samples of field mix), the following actions will be taken by TSS:

- First occurrence; the contractor will receive a warning letter from the TSS indicating the deficient TSR value.
- Second consecutive occurrence; In the event of a second consecutive low TSR value below 80.0 percent the contractor will have their production suspended until it can provide acceptable TSR test results to the TSS. During this period of time the Contractor, the Engineer, and TSS will meet to determine the impact of the non-compliance, and specify the necessary remedial action to be taken by the Contractor. Remedial action shall be either acceptance, acceptance at a pay adjustment as detailed in the following Table 6.3.10, or removal and replacement at no cost to the City. If suspended, the paving program shall only continue upon approval by TSS.

**Table 6.3.10: TSR Pay Factors**

Percentage of TSR	Pay Factor (%)
80.0 or higher	100.0
78.0 to 79.9	99.0
76.0 to 77.9	97.0
74.0 to 75.9	95.0
72.0 to 73.9	92.0
70.0 to 71.9	89.0
68.0 to 69.9	85.0
66.0 to 67.9	81.0
64.0 to 65.9	76.0
62.0 to 63.9	71.0
60.0 to 61.9	65.0
Less than 59.9	Grind and resurface

### 6.3.3.10 Cleanup

- Leave site clean and free of debris and surplus materials.
- Opening to Traffic: Open new SGC hot-mix pavement to traffic when the surface has cooled to ambient temperature or when authorized by the Engineer. Remove barricades and signs when no longer needed.



## 6.4 STONE MASTIC ASPHALT PAVING

### 6.4.1 General

#### 6.4.1.1 Content:

This section includes the supply and placement of Stone Mastic Asphalt (SMA) concrete for roadway paving.

#### 6.4.1.2 Related Sections:

- Section 6.4 – Stone Mastic Asphalt Concrete
- Section 6.6 Pavement Cold Milling
- Section 6.7 Liquid Asphalt Coats

#### 6.4.1.3 Definitions:

- **Overlay:** paving over an existing pavement for rehabilitation purposes and not as part of staged paving.
- **Staged Paving:** paving where a lift or lifts that form part of the total pavement structure are deferred to a future date.
- **SGC Density:** The SHRP Gyrotory Compactor (SGC) shall be used to prepare formed specimens at  $N_{\text{Design}}$  gyrations of 100. The SGC formed specimens shall be used for the determination of volumetric properties on a field produced mix as outlined in the Asphalt Institute SP-2 Manual.

#### 6.4.1.4 Quality Assurance:

- **Thickness Cores**

At the Engineer's request, the quality assurance laboratory will take one or more sets of cores from SMA pavement suspected to be deficient in total thickness, each set comprising 3 cores whose average thickness represents an area of not more than 1 000 m<sup>2</sup> of SMA pavement.

- **Asphalt Cement Content and Density Specimen Sampling and Testing**

The Quality Assurance Laboratory will:

- Determine the Maximum Theoretical Density (MTD) and asphalt cement content of SMA Field Specimens at a minimum frequency of one test for every 250 tonnes of SMA produced, or a day's production, whichever is less.

- Obtain two sets of cores from compacted mat placed from same load of SMA from which MTD specimens were obtained, and representing 1,000 m<sup>2</sup> or from suspect compacted mat, and test one set for density and the second set for rut testing (APA).
- **Basis of Acceptance:** Pavement compaction will be accepted on the basis of the ratio (in percent) of the core density to the Maximum Theoretical Density (MTD). If cores were taken from a mat where no MTD are available, acceptance will be based on the ratio of core density to the average MTD for that day's production.
- **Representative Cores:** A single core is initially taken representing the quantity of SMA in not more than 1 000 m<sup>2</sup> of mat, with a minimum of one core taken from a day's production. If the initial core density is below specified, that initial density is discarded, and 3 new cores will be taken within 10 m of the original core location at a minimum spacing of 2.5 m between cores. The average density of the 3 new cores represents that area.
- **Rutting Susceptibility Specimen Sampling and Testing**

The quality assurance laboratory will:

- Determine the rutting susceptibility of SMA Field Specimens at a minimum frequency of one test for every 500 t of SMA produced, or a day's production, whichever is less by subjecting the SMA specimens to the Asphalt Pavement Analyzer (APA) procedure. APA testing will be carried out by the City of Edmonton Quality Assurance laboratory or conversely the contractor may use an independent laboratory to perform APA testing. The APA device must meet the requirements of AASHTO T 340-10 and must be equipped with an automatic rut measurement system. The APA device must be calibrated at least once per year according to the procedures in the test method. In addition, the load cell used for checking wheel loads shall be calibrated at least once per year. Each test shall have 6 cylindrical samples fabricated and tested with the interior temperature of the APA set at 52° C. The downward force shall be set at 45 Kg and the hoses shall be pressurized to 689 kPa. Each specimen shall be compacted so that 7+/- 0.5 percent air voids are achieved. The APA rut test results shall be provided to the nearest 0.1 mm. The average rut depth for the specimens tested shall not exceed 5.0mm
- Determine the rutting susceptibility of SMA Field core Specimens taken at the location of the MTD samples by subjecting the SMA Field core specimens to the Asphalt Pavement Analyzer (APA) procedure as described in the above section. The average rut depth for the specimens tested shall not exceed 5.0mm. If the initial APA rutting is above specified, that initial APA result is discarded, and 3 new cores will be taken within 10 m of the original core location at a minimum spacing of 2.5 m between cores. The average APA result of the 3 new cores will be taken as to represent that area.

- **Tensile Strength Ratio (TSR) Specimen Sampling and Testing**

The quality assurance laboratory will:

- Determine the TSR of SMA Field Specimens at a minimum frequency of one test for every 500 t of SMA produced, or a day's production, whichever is less in accordance with AASHTO T283. The TSR must Exceed 75%

## **6.4.2 Products**

### **6.4.2.1 Materials**

- Stone Mastic Asphalt Concrete To Section 6.4 – Stone Mastic Asphalt Concrete.
- Tack Coat To Section 6.7 Liquid Asphalt Coats

### **6.4.2.2 Equipment**

- **Trucks for Transporting Mix:**

Trucks shall be compatible with size and capacity of the paver; with clean, tight, smooth-sided boxes equipped with waterproof tarpaulins of sufficient size to securely cover all material when boxes are fully loaded. The side of the truck box shall have a 12-mm diameter hole 300 mm from bottom for checking mix temperature. Use only approved release agents, such as water based liquid soap or dry soap powder and drain all excess release agents from truck beds.

- **Paver:**

Pavers shall be self-propelled; with automatic screed controls to maintain grade from a reference stringline or ski and to control crossfall, smoothness and joint matching; with vibratory screed equipped with vibratory extensions and augers capable of uniformly spreading the mixture to specified widths and depths without segregation or tearing. Follow the manufacturer's recommended operating procedures.

- **Rollers:**

Shall be self-propelled, reversible; static, oscillating or vibratory steel-drum rollers; with wetting and scraping devices to prevent adhesion of mix to drums or tires (petroleum derivatives are not permitted for cleaning); capable of attaining required density and smoothness. Follow the manufacturer's recommended operating procedures. Pneumatic-tired rollers are not to be used on SMA.

- **Hand Tools:**

Rakes, lutes, tampers, straightedges, levels, and other hand tools as necessary to complete the work shall be available.

### **6.4.3 Execution**

#### **6.4.3.1 Good Paving Practice**

- Production, Placement, Compaction and Quality Assurance of the SMA mix should be pursuant to the requirements of Chapter Three “Construction Procedures” as outlined in National Asphalt Paving Association’s QIP-122 booklet entitled “Designing and Constructing SMA Mixtures, State-of the Practice”.
- Refer to the latest edition of the “*Construction of Hot Mix Asphalt Pavements*”, Asphalt Institute Manual Series No. 22 (MS22), for guidance in good paving practice insofar as consistent with this Section.
- Provide an experienced foreman who shall be in full time attendance on the paving site to take charge of the entire paving operation from transporting of the mix to final rolling.
- **Test Strips and JMF Adjustment.** Do not begin full production of the SMA until receiving authorization from the Engineer. This authorization will be based on the successful construction of one or more test strips. Test strips will consist of 100 - 150 tons of SMA produced and placed in accordance with these specifications. No further SMA production will occur that day unless another test strip is needed. A test strip will consist of a full roadway width and be consistent with the contractor’s proposed laydown procedure. Test strips are incidental to the pay item. During the construction of a test strip, perform 1 set of quality control tests as described above and obtain and test 3 random cores of the compacted pavement. Within 1 working day after a test strip is completed, the Engineer, the Quality Control Laboratory and the Contractor will determine if any changes in the SMA JMF, production, or placement procedures are needed. If there is a redesign of the JMF another test strip may be required. The Quality Control Laboratory will notify the Engineer of any JMF adjustments. Do not start production until notified by the Engineer.

#### **6.4.3.2 Preparation**

- The Engineer will inspect the existing pavement, base or subbase before SMA paving. The Contractor shall repair imperfections and clean up as directed by the Engineer. Surface shall be true to line and grade within tolerance, firm, dry and free of loose and deleterious material.

- Catch basins, manholes, water valves, and other fixtures shall be brought to proper grade before the final lift. Provide temporary protection where necessary until completion of paving.
- Multiple Lift Paving
- Apply tack coat to the previous lift before placing a lift, unless permitted otherwise by the Engineer. Clean surface before tacking.
- Preparation for Overlay or for Succeeding Stage Paving
  - **Sweeping and Cleaning:** Sweep the existing pavement surface with an approved mechanical sweeper. Remove all residual debris and accumulations of deleterious material.
  - **Surface Milling:** If specified, grind the existing surface to specified depth according to Section 6.6 Pavement Cold Milling
  - **Tack Coat:** When the existing surface has passed inspection by the Engineer, apply tack coat to Section 6.7 Liquid Asphalt Coats.
  - Apply tack coat to surfaces intended to be in contact with SMA, including the sides of gutters, catch basins, manholes, and other concrete and metal fixtures. Before placing SMA, let tack coat completely cure and have tacked surfaces inspected by the Engineer
  - Asphalt Levelling Course: The Engineer will designate those areas having 25 mm or greater depressions for levelling course application. Spread the levelling course of SMA with a paver one lift at a time, not exceeding 75 mm compacted thickness, and compact to required density.

#### 6.4.3.3 Weather Limitations

- No paving is permitted when rain or snow is imminent, or when the surface or base to be paved is wet, icy, snow-covered or frozen, unless waived by the Engineer.
- No paving is permitted when air temperature and wind speed conditions are below the applicable mat curve in Chart 6.4.1, unless waived by the Engineer.

**Chart 6.4.1: Air Temperature and Wind Limitations on Paving**

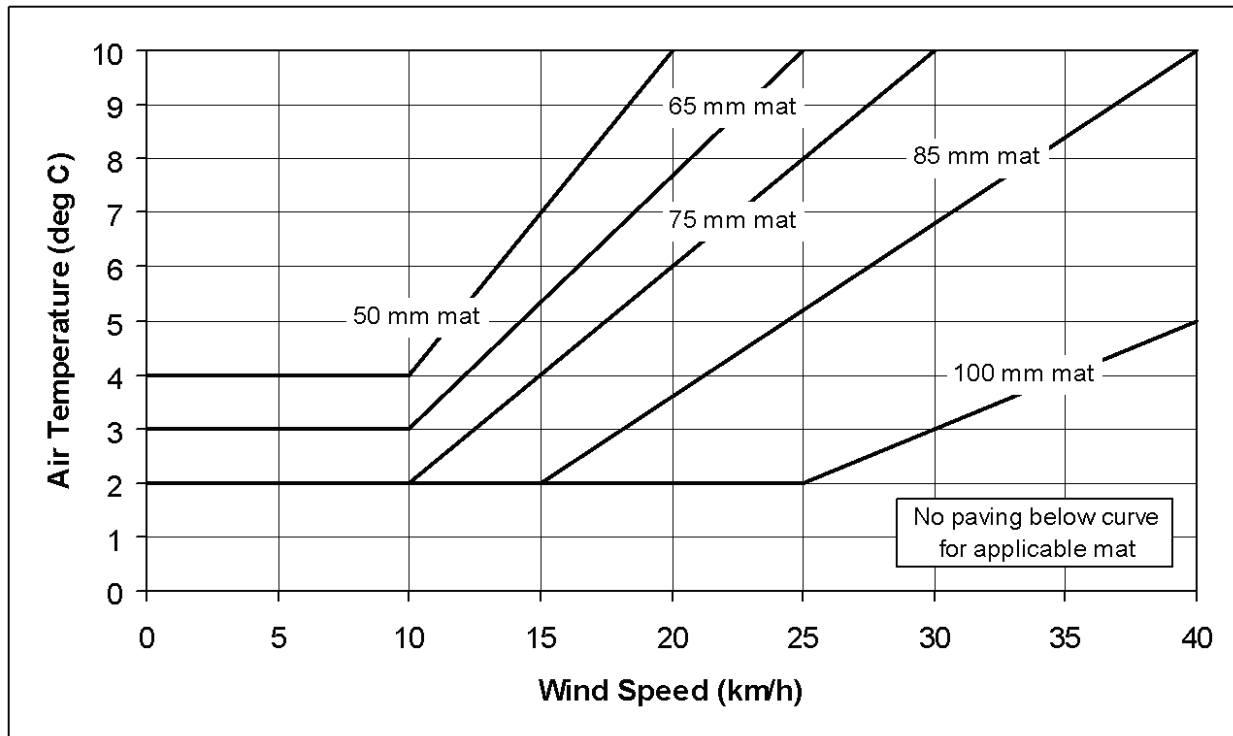

**6.4.3.4 Transportation of SMA**

- Transport the SMA in approved trucks with protective covers properly secured to the sides and back of truck box so that no funneling air movement develops under the cover during hauling.
- Before loading with SMA, thoroughly clean the box of any accumulation of asphaltic material. Lubricate inside surfaces with a light coating of soap or detergent solution. Petroleum derivatives are not permitted.
- Maintain trucks clean of mud and other material that could contaminate the paving area.
- Discharge SMA into the paver hopper without spilling and without the truck box bearing down on the hopper.
- If the unit for payment is tonnes, no payment will be made for SMA tonnage unless the Engineer is provided with a copy of the corresponding asphalt mix load ticket immediately upon arrival at the site.

#### 6.4.3.5 Spreading

Placing the SMA shall be a continuous operation with the paver moving at a uniform speed compatible with the rate of compaction rolling and SMA mix delivery.

- **Spreading Temperature of Mix**

Ensure that mix temperature meets the PMA binder manufacturer's requirements.

- **Segregation**

If segregation of mix material occurs, the Engineer will immediately suspend spreading until the cause is determined and corrected.

Prior to roller compaction, remove fat spots, sandy accumulations, high and low spots, and other irregularities and repair with SMA. Scratch surface with rake tynes to ensure bonding of added mix. Do not spread loose SMA that has been raked off onto the mat.

#### 6.4.3.6 Hand Spreading

- Hand spread SMA in small areas not accessible to paver, and where permitted by the Engineer.
- Do not broadcast SMA. Hand place carefully to avoid segregation of coarse and fine aggregate. Use lutes and rakes to thoroughly loosen and uniformly distribute the SMA. Remove lumps that do not break down readily.
- Heat hand tools to prevent asphalt sticking. Do not overheat tools to prevent damaging of the SMA.
- Before rolling, check surface with template or straightedge, and correct irregularities.

#### 6.4.3.7 Compaction

- Compact the asphalt mat with rollers in good working order and operated by competent operators. Use the number, type and mass of rollers required to obtain the required compaction within the available compaction time and compatible with the rate of hot-mix placement.
- Develop and follow the best pattern of rolling to obtain the most uniform compaction across the mat including joints and edges without degrading the aggregate through over compaction. Indicate the rolling pattern to the Engineer when requested.
- Perform compaction rolling with rollers following the paver as closely as possible, until required density is obtained. Perform finish rolling to eliminate equipment marks and to create a surface with a uniform tightly knit texture.
- Complete final rolling before the mat temperature reaches 90°C.

- For small areas inaccessible to rollers, use an approved vibratory plate compactor or hand tamper to thoroughly compact the SMA.
- If compaction or finish rolling difficulties occur, suspend paving operations, redesign the mix and obtain Engineer's approval of a trial batch before resuming paving.

#### **6.4.3.8 Joints**

- **Transverse Joint**
  - Plan length of spread to provide for a minimum 1 m offset of transverse joints in successive lifts and adjacent mats.
  - Transverse joints shall be straight, have a vertical face painted with tack coat before placement of the adjacent mat, be thoroughly compacted, and meet surface tolerances.
- **Longitudinal Joint**
  - Location: Plan mat limits to ensure that surface longitudinal joints will be offset not more than 150 mm from the centre of a proposed pavement marking line between travel lanes. If permitted by the Engineer, the joint may be located at the centre of a travel lane.
  - Plan width of spread to provide for a minimum 150 mm offset (in a dovetail pattern) of longitudinal joints in successive lifts.
  - Create a longitudinal joint while the temperature at the edge of the first of two adjacent mats is above 100 °C. Allow an overlap of 25 to 50 mm between mats. This may be accomplished by multiple pavers in staggered formation, or by limiting paver advance. Allow an overlap of 25 to 50 mm between mats
  - Do not roll the narrow strip along edge of first mat until the adjacent mat is placed. Roll the joined mat immediately to insure bonding while the mix is still hot.
  - If a hot longitudinal joint as described in 3.8.2.3 cannot be created, then carefully roll the edge of the first mat, form or cut a clean vertical face to full depth of the mat, and paint with tack coat before placing the adjacent mat.
  - The finished longitudinal joint shall be thoroughly compacted and shall meet surface tolerances.



### 6.4.3.9 Field Quality Control

- Smoothness Tolerances

Maximum variation under 3 m straightedge as follows:

- Longitudinal (in the direction of travel): 3 mm.

Transverse (across the direction of travel): 6 mm  
(straight crossfall)

- Grade:  $\pm 6$  mm maximum variation from designated grade elevations.

- **Texture:** Finished surface shall be free of visible signs of poor workmanship such as, but not limited to:

- Segregation, as demonstrated through sandy spots or excessively open spots (areas of water bleeding from the mat),
- Areas exhibiting excess or insufficient PMA Binder, as demonstrate through Fat spots.
- Improper matching of longitudinal and transverse joints,
- Dimpling, roller marks, cracking, or tearing.
- If surface and grade tolerances are exceeded, or if surface texture is not met, grind down and resurface defective areas as directed by the Engineer.

- **Thickness Tolerance:**

- Deficient Thickness: If average core thickness is deficient that area of asphalt pavement will be assessed a pay factor according to Table 6.4.1 to be applied to the price of the quantity of SMA in that mat area.
- Excess Thickness: Asphalt pavement with excess thickness may be accepted with no extra payment, if surface and grade tolerances and texture are met.

**Table 6.4.1: Asphalt Thickness Pay Factors**

THICKNESS DEFICIENCY (%)	PAY FACTOR (%)
10.0	100.0
11.0	97.0
12.0	93.7
13.0	90.0
14.0	85.5
15.0	80.5
16.0	75.0
17.0	68.0
18.0	60.0
19.0	50.0
Over 19.0 %	Grind and resurface

○ **Density Tolerance**

- Required Density: Each mat of SMA placed shall be compacted to 94% of MTD.
- Deficient Density: If the average core density is below specified, the represented area of mat may be accepted subject to a pay factor according to Table 6.4.2 to be applied to the price of the quantity of SMA in that mat area.

**Table 6.4.2: Asphalt Density Pay Factors**

Percentage of MTD	Pay Factor (%)
94.0	100.0
93.9	99.9
93.8	99.8
93.7	99.6
93.6	99.4
93.5	99.1
93.4	98.7
93.3	98.3
93.2	97.8
93.1	97.2
93.0	96.5
92.9	95.8
92.8	95.0
92.7	94.2
92.6	93.3
92.5	92.3
92.4	91.1
92.3	89.8
92.2	88.5
92.1	87.1
92.0	85.5
91.9	83.8
91.8	82.0
91.7	80.0
91.6	77.7
less than or equal to 91.5	REJECT

- **APA Tolerance**

Maximum APA rutting: If average core APA rutting is above 5.0mm that area of asphalt pavement will be assessed a pay factor according to Table 6.4.3 to be applied to the price of the quantity of SMA in that mat area.

**Table 6.4.3: Asphalt APA Rutting Pay Factors**

APA RUTTING MEASUREMENT (mm)	PAY FACTOR (%)
5.0	100.0
5.2	95.0
5.4	90.0
5.6	85.0
5.8	80.0
6.0	75.0
6.2	70.0
6.4	65.0
6.6	60.0
6.8	55.0
Equal to or over 7.0 mm	Grind and resurface

○ **Asphalt Cement Content Tolerance**

Deficient Asphalt Cement Content: If the asphalt cement content as determined by the Quality Assurance agency indicates low or high asphalt cement content, the represented area of mat may be accepted subject to a pay factor according to Table 6.4.4 to be applied to the unit price of the 250 tonnes or equivalent area of hot-mix in the mat.

**Table 6.4.4: Asphalt Cement Pay Factors**

Quality Assurance Asphalt Cement Content (%)	PAY FACTOR (%)
± 0.0 – 0.20	100.0
± 0.21 - 0.25	98.0
± 0.26 – 0.30	94.0
± 0.31 - 0.35	90.0
± 0.36 – 0.40	86.0
± 0.41 – 0.45	82.0
± 0.46 – 0.50	78.0
± 0.50	Reject

#### **6.4.3.10 Cleanup**

- Leave site clean and free of debris and surplus materials.
- Opening to Traffic: Open new pavement to traffic when the surface has cooled to ambient temperature and when authorized by the Engineer. Remove barricades and signs when no longer needed.

## 6.5 PAVING BRICK ON SAND BED

### 6.5.1 General

#### 6.5.1.1 Content

This section includes to supply and placement of clay paving brick with sand bedding on soil cement base, for pedestrian and light vehicle traffic.

#### 6.5.1.2 Related Sections

- Aggregate Section 2.1
- Concrete Base Section 7.4
- Cement Concrete Section 7.1
- Concrete for Roadways Section 7.3

#### 6.5.1.3 Submittals

- Submit the manufacturer's product data together with 2 samples representative of style, size, colour range and surface texture to the City at least 14 days prior to delivery of brick pavers on site. Submit further samples as requested by the City.
- Submit source and gradation of bedding and joint sand to the Technical Services Section, Transportation and Streets Department at least 7 days prior to use.

#### 6.5.1.4 Quality Assurance

- The quality assurance laboratory will test paving brick for compressive strength and absorption to ASTM C902.
- Brick not meeting specifications shall be replaced.

### 6.5.2 Products

#### 6.5.2.1 Materials

- **Paving Brick:** to ASTM C902, class SX, type 1, solid fired clay units, conforming to the following:
  - Compressive strength at time of delivery: minimum 55 MPa average of 5 test samples with no unit less than 50 MPa.
  - Moisture absorption at time of delivery: maximum 8% average of 5 test samples with no unit more than 11%.
  - Size: 200 mm x 100 mm x 60 mm  $\pm$ 2 mm in any dimension.

- Shape and Colour: as indicated on drawings or as ordered.
- **Bedding Sand:** to Section 2.1 - Aggregate, Designation 4, class 10.
- **Joint Sand:** to Section 2.1 - Aggregate, Designation 4, class 2.5, with 6% bentonite.
- **Edge Restraint:** pressure treated wood, concrete or other material or structure as indicated on drawings.
- **Weed Barrier:** as indicated on drawings.
- **Insulation:** as indicated on drawings.

### 6.5.3 Execution

#### 6.5.3.1 Preparation

- Construct concrete base to Section 7.1 – Cement Concrete and 8.3 – Concrete for Roadways with the following modified tolerances:
  - Smoothness: 8 mm maximum variation under 3 m straightedge.
  - Grade: 0 mm maximum variation above designated elevation.
    - 8 mm maximum variation below designated elevation.
- The concrete base shall be inspected by the City before placing bedding sand. Repair imperfections and clean surface of debris and loose material. Do not use bedding sand for corrective levelling.
- Edge Restraint: Install as detailed on drawings.
- Weed Barrier: Install as detailed on drawings.
- Insulation: Install as detailed on drawings.

#### 6.5.3.2 Sand Bedding

- Bedding sand shall have a uniform moisture content of 6% to 8% by mass when spread.
- Spread sand uniformly and screed lightly to achieve a uniform thickness of 30 ±8 mm after placement and tamping of paving brick.
- Alternatively, spread sand in a loose lift of sufficient thickness to achieve 2/3 of the required thickness and lightly tamp with one pass of a plate vibrator. Then spread and screed the remaining lift of loose sand onto which the paving brick can be laid.
- Once screeded, the sand shall not be disturbed. If screeded sand is disturbed or exposed to rain or dew, it shall be removed or loosened, re-spread and re-screed.

- Place no more sand than will be covered with paving brick on the same day.

#### **6.5.3.3 Laying Paving Brick**

- Lay paving brick on sand bed in the specified pattern, leaving joint spaces no wider than 3 mm.
- Arrange brick to maximize the use of full bricks and to minimize the use of slivers. Fill edge gaps with units cut with a masonry saw.
- Use planks for foot and wheelbarrow traffic to prevent disturbance of units prior to tamping.
- Tamp brick with a flat plate vibrator shortly after laying to bring surface to correct grade, eliminate lipping between adjacent units and consolidate sand bedding. Remove and replace damaged brick.
- Tamp all brick laid in a day's work except brick within 1 m of laying edge.
- Brush and vibrate joint sand to completely fill joints between units. Sweep and remove excess sand and leave finished surface clean.
- Check finished surface to ensure surface and grade tolerances are met.

#### **6.5.3.4 Field Quality Control**

- Surface Tolerance:      6 mm maximum variation under 3 m straightedge.  
   2 mm maximum differential level between adjacent units and between units and edge restraint.
- Grade Tolerance:      6 mm maximum variation above designated elevation.  
   0 mm maximum variation below designated elevation.

#### **6.5.3.5 Protection and Cleanup**

- Do not open newly installed paving brick to pedestrian or vehicle traffic until directed by the Engineer.
- Before opening to traffic, ensure that surface is clean and free of surplus material or debris.



## 6.6 PAVEMENT COLD MILLING

### 6.6.1 General

#### 6.6.1.1 Content:

This section includes cold milling or grinding of existing asphalt or concrete pavement surfaces.

### 6.6.2 Products

#### 6.6.2.1 Materials

**Millings:** Unless stated otherwise in the Special Provisions, millings shall become the property of the Contractor, who shall remove and transport the millings to the location of the Contractor's choice at the Contractor's expense.

#### 6.6.2.2 Equipment

- Cold Planer: Selfpropelled; capable of milling 4,000 m<sup>2</sup> of pavement surface in an 8 hr shift; capable of loading millings into haul vehicles; with a mandrel cutting a minimum width of 1.52 m; with sufficient power to cut a minimum 50 mm depth in one pass; with slope and grade adjustment controls.
- All equipment shall be suitably muffled to conform to the City of Edmonton's Bylaw 1460 Community Standards Bylaw Part III – Noise Control.

### 6.6.3 Execution

#### 6.6.3.1 Traffic Safety

- ,Provide signed advance warning of cold milled areas opened to traffic before paving, as follows:
  - 'Bump'** - all transverse milled edges and edges at exposed utility structures.
  - 'Uneven Pavement'** - all longitudinal milled edges, and edges within pedestrian crosswalk areas.
- Ramp vertical edges created by milling operations according to the following tables. Material used in ramping must be approved by the Engineer and must be maintained until removal prior to paving.

**Table 6.6.1: Transverse Edges**

Depth of Milling (mm)	Speed Limit (km/h)	Length of Ramp (mm)	Location of Ramp
0 - 50	< 60	600	At end of milled area (up ramp)
0 - 50	≥ 60	1200	At end of milled area (up ramp)
> 50	< 60	600	At start of milled area (down ramp)
		600	At end of milled area (up ramp)
> 50	≥ 60	600	At start of milled area (down ramp)
		1200	At end of milled area (up ramp)

**Table 6.6.2: Localized Edges - Manholes, Vault Covers, Valves, Etc**

Depth of Milling (mm)	Speed Limit (km/h)	Length of Ramp (mm)	Location of ramp
< 25	all speeds	N/A	Paint all edges in fluorescent colour
25 or greater	all speeds	600	At all edges of milled area

**Table 6.6.3: Patch Milled Edges**

Length of Milled Area (m)	Speed Limit (km/h)	Length of Ramp (mm)	Location of Ramp
0 - 15	< 60	600	At start of milled area (down ramp)
		600	At end of milled area (up ramp)
0 - 15	≥ 60	600	At start of milled area (down ramp)
		1200	At end of milled area (up ramp)

**6.6.3.2 Preparation**

- Sweep the pavement surface with a mechanical sweeper to remove debris and dirt accumulations.
- Remove any standing water from the pavement surface.

### **6.6.3.3 Milling**

- Mill to depth and/or gradeline as determined by the Engineer.
- Mill pavement to expose vertical surface of gutter face, manhole frames, water valves, survey monuments, power, telephone, or water vaults, or any other structures within milling area for the full required depth of milling.
- Load millings into haul vehicles and transport to the Contractor's chosen location.
- Minimize use of water during milling.

### **6.6.3.4 Cleanup**

- Leave milled areas clean to the satisfaction of the City upon the completion of milling.
- Immediately remove and dispose of any spilled millings on milled areas and on haul routes.

## 6.7 LIQUID ASPHALT COATS

### 6.7.1 General

#### 6.7.1.1 Content

This section includes:

- **Asphalt prime coat:** the supply and application of liquid asphalt to seal the surface of granular base courses or soil cement and to provide a bond with subsequent paving courses.
- **Asphalt tack coat:** the supply and application of liquid asphalt to provide a bond between existing asphalt or concrete surface and the overlying asphalt course.
- Specifications for liquid and emulsified asphalts.

#### 6.7.1.2 Submittals

Submit refinery data to the Technical Services Section, Integrated Infrastructure Services prior to first use and as requested by the Engineer

#### 6.7.1.3 Quality Assurance

The quality assurance laboratory may take and test samples of liquid asphalt used weekly from each source. Material not meeting specifications shall be replaced.

### 6.7.2 Products

#### 6.7.2.1 Materials

Liquid or Emulsified Asphalt: types and grades as indicated below and conforming to related properties in Tables 6.7.2 and 6.7.3.

**Table 6.7.1: Liquid or Emulsified Asphalt Types and Grades**

	Liquid Asphalt Type & Grade	Application Rate litres/m <sup>2</sup>	Concentration
<b>Prime Coat</b>	MS-1	1.5 ±0.5	100%
<b>Tack Coat</b>	SS1	0.5 ±0.2	50%
	MS-1	0.5±0.2	100%
	MC-30*	0.3 ±0.1	100%

\*Note: only to be used for paving on Bridge Decks

Dilute SS1 emulsified asphalt with an equal amount of water.

### 6.7.2.2 Equipment

- **Pressure Distributor:** shall be self-powered, equipped with a tachometer, a pressure gauge, an adjustable length spray bar, a positive displacement asphalt pump with a separate power unit, heating coils and a burner for even heating of asphalt and a thermometer. The pressure distributor shall be capable of maintaining a uniform speed and provide uniform application of liquid asphalt at the designated rate to areas up to 4 m wide.
- **Hand Spray Wand:** shall have a nozzle connected by a hose to a pressure distributor and shall be capable of the uniform application of liquid asphalt.

### 6.7.3 Execution

#### 6.7.3.1 Common Requirements

- Prepare surface to be coated to the applicable Section. Have the surface inspected by the City before coating.
- Protect adjoining curb, gutter, walk, slabs, barrier, poles and other surfaces not intended for coating, from splattering or overspray. Remove any splattering stains.
- Do not apply liquid asphalt when the weather is foggy, rainy, windy, or when the air temperature is below 2°C, unless otherwise permitted by the Engineer.
- Spray liquid asphalt to a uniform coat. Do not spray excessively to create ponding. Hand spray areas missed by or inaccessible to the distributor.

#### 6.7.3.2 Prime Coat

- Apply prime coat while the soil cement surface is still moist.
- Do not allow traffic on prime coat within 6 hours of application or until the prime coat has cured.

#### 6.7.3.3 Tack Coat

- Do not apply tack coat unless the surface is dry and free of dust and other material that could reduce the bond.
- Apply tack coat only to an area that can be paved in the next 24 hours.
- Minimize construction traffic on the cured tack coat. Reapply the tack coat if damaged by traffic.

Table 6.7.2: Specifications for Medium Curing Asphalt

ASPHALT GRADE REQUIREMENTS	ASTM TEST	MC-30	
		Min	Max
Flash Point, Open Tag, °C	D-1310	38	-
Kinematic Viscosity at 60°C, mm <sup>2</sup> /s	D-2170	30	60
Distillation Test:			
% by volume of total distillate to 360°C	D-402		
- 190°C		-	-
- 225°C		-	25
- 260°C		40	70
- 315°C		75	93
Residue from distillation to 360°C			
Volume % by difference		50	-
Tests on Residue from Distillation:			
Penetration at 25°C, 100 g, 5 s, dmm	D-5	120	250
Ductility at 25°C, cm	D-113	100	-
Solubility in Trichloroethylene, % by mass	D-2042	99.5	-
Water, % by mass or volume	D-95	-	0.2
Delivery Temperature, °C		35	55

Note: If the ductility at 25°C is <100 cm, the material will be acceptable if the ductility at 15°C is >100 cm

**General Requirements:** The asphalt shall not foam when heated to the application temperature range.  
The asphalt shall be produced by the refining of petroleum and shall be uniform in character

**Table 6.7.3: Specifications for Anionic Emulsified Asphalt**

ASPHALT GRADE REQUIREMENTS	ASTM TEST	SS-1		SS-1H		MS-1	
		Min	Max	Min	Max	Min	Max
Viscosity at 25°C, SF s	D-88	20	60	20	60	20	100
Residue by Distillation, % by mass	D-244	55	-	55	-	55	-
Settlement in 5 days, % difference by mass	D-244	-	5	-	5	-	5
Storage Stability Test, 24 hour, % by mass	D-244	-	1	-	1	-	1.5
Retained on No. 1000 sieve, % by mass	D-244	-	0.10	-	0.10	-	0.10
Cement Mixing Test, % by mass	D-244	-	2.0	-	2.0	-	2.0
Tests on Residue from Distillation:							
Penetration at 25°C, 100 g, 5 s, dmm	D-5	100	200	40	100	100	200
Ductility at 25°C and 5 cm/minute, cm	D-113	60	-	60	-	40	-
Solubility in Trichloroethylene, % by mass	D-2042	97.5	-	97.5	-	97.5	-
Delivery Temperature, °C		40	70	40	70	40	70

**Notes:** The upper limit on % residue is governed by the consistency limits.  
 The test for settlement may be waived when the emulsified asphalt is used in less than 5 days.  
 The 24 hour storage test may be used in place of the 5 day settlement test. However, in case of dispute the 5 day storage settlement test shall govern.  
 CAN/CGSB8.2M Sieves, woven wire, metric shall be used for the sieve test.

**General Requirements:** All tests shall be performed within 15 days of the date of delivery.  
 The asphalt shall be uniform in character and shall have a refined petroleum base.

## 6.8 FULL DEPTH RECLAMATION USING FOAMED ASPHALT

### 6.8.1 General

#### 6.8.1.1 Content

This section includes the pulverization of existing asphalt, soil cement and/or aggregate roadway structures, the addition and mixing of stabilizing agents into the reclaimed base, and the grading and compaction of the reclaimed base course.

#### 6.8.1.2 Related Sections

- Grading Section 2.3
- Cement Stabilized Subgrade Section 4.2
- Proof Rolling Section 4.3
- Granular Base Courses Section 5.1
- Full Depth Reclaimed Base Course Section 6.8

#### 6.8.1.3 Definitions

##### **Full Depth Reclamation Using Foamed Asphalt:**

- Full Depth Reclamation (FDR) Using Foamed Asphalt shall consist of a full depth recycling process, where the existing bituminous cover and the top portion of the underlying base material are reclaimed and transformed into a homogenous mixture by an in-place process using foamed asphalt and if required additional course aggregate and granular material;
- FDR shall be performed by utilizing a recycling machine to pulverise, to the depth shown on the plans, the materials in the upper layers of the existing pavement structural section together with any imported aggregate base and to achieve the required grading and consistency of mix in a single pass. The recycled material shall exit from the mixing chamber in a manner that prevents particle segregation. Spreading and placing to form the new structural section shall be by motor grader or screed mounted on the rear of the recycling machine. Pre-pulverizing may be done prior to the foamed asphalt application with no extra compensation.
- Pulverize and reuse materials in the upper layers of the existing roadway structural section;
- Adjust the gradation of the existing materials by the addition of imported aggregate base (Admixture Aggregate) if and where necessary;
- Procure, furnish, and mix in a combination of foamed bitumen and cementitious stabilizing agents together with sufficient water to approximate the optimum moisture content; and



- Place and compact to achieve a new structural section, as shown on the plans, as specified in the Standard Specifications and these special provisions, unless otherwise directed by the Engineer.

#### 6.8.1.4 Quality Assurance

- **Maximum Density:** the dry unit mass of a sample at optimum moisture content as determined in the laboratory according to ASTM D1557
- **Required Density:** a minimum of 98% of the maximum density in accordance with ASTM D1557 for the full depth foam in-place recycled material.
- **Testing Frequency:** the quality assurance laboratory will take a minimum of one field density test for each 1 000 m<sup>2</sup> of compacted full depth foam in-place recycled material according to ASTM D2167 or ASTM D2922 for comparison with a maximum density determined according to ASTM D1557.
- Where subgrades/bases are not protected, density tests obtained prior to a rain event are obsolete and the lot must be retested.

### 6.8.2 Products

#### 6.8.2.1 Materials

- **Cementitious Stabilizing Agent:** Cement to, CSA A3001Type GU, General use cement shall be the only cementitious stabilizing agent employed in the full depth foam in-place Recycling process
- **In-Situ Materials:** The existing pavement structure to be pulverized has been investigated, and the results are included in the contract Special Provisions. If additional coring or sampling is desired, the coring or sampling shall be at the expense of the Contractor.
- **Bituminous Stabilizing Agents:** Foamed bitumen shall be the only bituminous stabilizing agent employed in the full depth foam in-place recycling process. Foamed bitumen shall be produced from Asphalt Cement: PG 58-28 to AASHTO M320, Table 2 which is included in these specifications as Table 6.8.5 and Table 6.8.6.
- **Water:** May be obtained from City fire hydrants according to the General Requirements. Other water sources are subject to the Engineer's approval.
- **Admixture Aggregate:** 20mm aggregate to be incorporated into the existing road structure to ensure adequate fines for stabilization shall meet the following gradation:

**Table 6.8.1: Gradation Requirements for Admixture Aggregate**

Sieve Size	Percent Passing
20 000	100
12 500	60-90
5 000	40-60
2 000	25-45
400	15-25
160	10-20
80	10-15

### 6.8.2.2 Foamed Bitumen Mix Design

- Submit to the TSS for approval a Foamed Bitumen Mix Design performed by a qualified laboratory at least 14 days before initial Foamed Bitumen Recycling work for each location. The mix design should be carried out in accordance with the mix design method detailed in the Wirtgen Cold Recycling Manual current edition.
- The design of the foamed asphalt shall be completed with a laboratory asphalt expanding plant. The half -life and expansion ratio of the expanded asphalt bitumen shall be determined at a minimum of five (5) moisture contents. A minimum of two (2) trials shall be completed for each moisture content and the average values obtained shall be used in the final analysis. The moisture content of the expanded asphalt bitumen shall be established to provide a maximum expansion ratio and maximum half-life. The moisture content of the binder shall be selected to provide a minimum half-life of eight (8) seconds.
- The mix design sample shall be a representative sample of the roadway being rehabilitated and shall be obtained using the anticipated recycling equipment.

### 6.8.2.3 Foamed Bitumen Mix Design Criteria

- **Aggregate Gradation:** The combined/pulverized material should meet the following gradation:

**Table 6.8.2: Aggregate Gradation for the Combined/Pulverized Material**

Sieve Size	Percent Passing
38 000	100
20 000	70-100
12 500	60-85
5000	45-70
2 500	33-60
400	15-35
160	10-25
80	5-20

- **Cement Content:** minimum 1.0% by mass of dry aggregate used for tendering mix design requirement governs.
- **Bitumen:** Minimum 2.6% by mass of dry aggregate used for tendering mix design requirement governs.
  - The mix design should be performed at various bitumen contents using Marshall criteria of 75 blows per face. The Indirect Tensile Strength (ITS) of the specimens should be determined for both the soaked and un-soaked specimens. The soaked specimens should be placed under water at 25° C ± 1° C for 24 hours. Remove the specimens from the water and surface dry the specimen prior to performing ITS testing. The ratio of un-soaked to soaked Tensile Strength (TSR) must be a minimum of 50%
  - The final design shall be based on a foamed bitumen content that provides:
    - Optimum bulk Density
    - Optimum dry strength properties
    - Optimum wet strength properties
    - Optimum resistance to moisture penetration

**6.8.2.4 Equipment**

- **Reclaimer/Stabilizer:** a roadway structure pulverizing machine with the following characteristics, and subject to the Engineers approval:
  - A minimum power capacity of 600 horsepower;
  - A milling drum that rotates upward into the direction of advance with a minimum cut width of 2.0 m;

- The capability of pulverizing asphalt, soil cement and gravel roadway structures to depths of at least 400 mm in a single pass, and accurately maintaining a pre-set depth of cut;
  - Due to the cut depths as detailed in the contract documents, there is no requirement for the effective volume of the mixing chamber to be increased in relation to the depth of cut.
  - Two microprocessor controlled systems, complete with two independent pumping systems and spraybars, one to regulate the application of foamed bitumen stabilizing agent and a separate system to regulate the water (for increasing the moisture content of the recycled material), both in relation to the forward speed and mass of the material being recycled;
  - Two spraybars shall each be fitted with nozzles at a maximum spacing of one nozzle for each 155mm width of chamber; the contractor shall ensure that all nozzles utilized in the foamed asphalt process shall be maintained in working order for the duration of the process;
  - The foamed bitumen shall be produced at the spraybars in individual expansion chambers, or one large expansion chamber, into which hot bitumen and water are injected under pressure through orifices that promote atomization. The rate of addition of water into hot bitumen shall be kept at a constant (percentage by mass of bitumen) by the same microprocessor;
  - An inspection (or test) nozzle shall be fitted at one end of the spraybar that produces a representative sample of foamed bitumen;
  - An electrical heating system capable of maintaining the temperature of all bitumen flow components above 150°C;
  - A single bitumen feed pipe installed between the modified milling or recycling machine and the supply tanker can be used. A system that incorporates a return pipe to the supply tanker may be used providing the overall temperature of the bitumen can be maintained;
- **Compaction Equipment:** self-propelled vibratory steel drum, sheepfoot/padfoot rollers and pneumatic-tired rollers capable of achieving the required compaction of the cold foam in-place recycled material, and providing a surface suitable for the placement of hot-mix asphalt concrete. The frequency and amplitude of vibrating rollers shall exceed a static mass of 15 tons and shall be adjustable.
  - Supply Tankers for Bituminous Stabilizing Agent: Only tankers with a capacity exceeding 10,000 L shall be used to supply the recycling machine with bitumen. Each tanker shall be fitted with two recessed pin-type two hitches, one in front and the other in the rear,

thereby allowing the tanker to be pushed from behind by the recycling machine, and to push a water tanker in front. No leaking tanker will be permitted on the job site. In addition, each tanker shall be equipped with the following:

- A thermometer to show the temperature of the bottom third of the tank;
- A rear feed valve, with a minimum internal diameter of 75mm, capable of draining the contents of the tank when fully opened;
- All-round cladding to retain heat;
- A calibrated dipstick marked at intervals of no more than 100 litres, for measuring the contents of the tank.

### 6.8.3 Execution

#### 6.8.3.1 Preparation

- Roadway areas to be reclaimed will be indicated on plans or designated by the Engineer.
- Ensure that any conflicts with underground utilities in the zone of reclamation are resolved prior to pulverization.
- The Contractor is responsible for clearing all foreign matter from the entire roadway width, including any adjacent lanes or shoulders that are not to be recycled.
- The contractor is responsible for the removal of all standing water.

#### 6.8.3.2 Unsuitable Weather Conditions

- **Wet Weather:** No full depth foam reclamation work shall be performed during wet conditions, nor started without completing before wet conditions set in.
- **Cold Weather:** No full depth foam reclamation work shall be performed if the ambient pulverized roadway material temperature is below 0°C other than finishing and compaction operations.
- **Windy Weather:** Spreading of cementitious stabilizing agents on the roadway ahead of the recycling machine will not be allowed when windy conditions adversely affect the operations.
- **Time Limitations:**
  - The maximum time period between mixing the recycled material with a stabilizing agent and compacting the placed material shall be determined by the type of stabilizing agent applied. Where combinations of two or more different stabilizing agents are used, the stabilizing agent that predominates shall dictate

the time limitation. Where Cement is added in conjunction with a bituminous stabilizing agent at an application rate of less than 2 percent, the time limit of the bituminous stabilizing agent shall apply. The maximum time periods shall be as follows:

**Table 6.8.3: Time Limitations**

Stabilizing Agent	Time Limit
GU Cement	3 Hours
Bitumen Emulsion	Before the emulsion breaks
Foamed Bitumen	24 Hours if kept moist

**6.8.3.3 Production Plan**

- Prior to beginning with the recycling work each day, the Contractor shall prepare a production plan detailing proposals for the forthcoming day’s work. The production plan shall contain the following information:
- A sketch showing the overall layout of the length and width of roadway intended for recycling during the day, broken into the number of parallel cuts required to achieve the stated width, and the overlap dimensions at each joint between cuts;
- The sequence and length of each cut to be recycled before starting on the adjacent or following cut;
- An estimate of the time required for pulverizing, mixing and compacting the cut. The sketch shall also show the time when completion of each is expected;
- The proposed water addition for each cut;
- The quantity and location where aggregate base is to be imported;
- The amount and type of stabilizing agent, or agents, to be applied to each cut;
- The proposed quality control testing program; and
- Any other information that is relevant for the intended work.

**6.8.3.4 Pulverization**

- Pulverize the existing roadway structure into fragments no larger than 25mm maximum dimension, exclusive of existing aggregate. The forward speed of the recycling machine, rotation rate of the recycling drum, and the positioning of the gradation control beam shall be set to break down the in-situ material to an acceptable grading.

- The Contractor shall take all necessary steps to ensure that the grading of the recycled material conforms to the requirements specified in “Test Sections” of these specifications.
- In the event that the roadway is pre-pulverized, shaped and recompacted prior to the addition of stabilizing admixtures. The pre-pulverized material shall be compacted to the satisfaction of the Engineer to allow use of the roadway prior to further processing.

#### **6.8.3.5 Addition of Water and Stabilizing Admixtures**

- Add stabilizing admixtures to the reclaimed base course as specified or as directed by the Engineer.
- **Cement:** as detailed in Section 6.8.2.1 Cementitious Stabilizing Asphalt of these Specifications.
- **Bituminous stabilizers:** as detailed in Section 6.8.2.1 – Bituminous Stabilizing Agent of these Specifications.
- Ensure that the stabilizing admixtures are uniformly distributed and mixed with the pulverized material. The microprocessor control system for the addition of water and foamed bitumen shall be set and carefully monitored to meet the required compaction moisture and stabilizer content. Bulk bitumen tankers shall be dipped at the end of each cut in order to determine actual usage against the calculated theoretical demand.

#### **6.8.3.6 Overlap of Longitudinal Joints**

- Premark cut lines on the road surface designating the width of each cut in a section of the roadway.
- To ensure complete recycling across the full width of the roadway, longitudinal joints between successive cuts shall overlap a minimum of 150mm.
- Pre-marked cut lines on the road surface shall be checked to ensure that the width of the first cut is equal to that of the milling drum and that the width of all successive cuts shall be narrower than the drum width by at least 150mm. The milling/Recycling machine shall be steered so as to accurately follow the pre-marked lines. Any deviation in excess of 50mm shall be rectified immediately by reversing to where the deviation commenced and reprocessing along the correct line, without the addition of any further water or stabilizing agent.
- The overlap width shall be confirmed before starting each new cut sequence and any adjustments made to ensure that the amount of water and fluid stabilizing agents to be added is reduced proportionately by the width of the overlap.

### **6.8.3.7 Continuity of Stabilized Layer**

- The Contractor shall ensure that there is no gap of unrecycled material created between successive cuts (along the same longitudinal cut line), nor any untreated wedges created by the entry of the milling drum into existing material by:
- Carefully marking the exact location at which each cut terminates, this mark shall coincide with the position of the center of the pulverizing drum at the point at which the supply of stabilizing agent ceased.
- Start the next successive cut at least 0.5m behind this mark to ensure continuity.

### **6.8.3.8 Subgrade Instability**

- Where subgrade instability is encountered during the recycling process, the subgrade shall be:
- Excavated and removed to a depth of 600mm; and
- Replaced and backfilled with 3-20A granular base placed in lifts not exceeding 150mm when compacted and followed by successive layers until the level of the existing roadway is reached.

### **6.8.3.9 Grading and Compaction**

- To Section 2.3 – Grading and Section 5.1 – Granular Base Courses.
- Leave the surface of the compacted recycled material slightly higher than the required elevation; then trim to the design crown and grade. Leave the finished surface even and free of depressions, humps or loose material.
- Rolling shall commence as soon as it is practical, and follow the predetermined sequence specified in “Test Sections” of these specifications.

### **6.8.3.10 Watering, Finishing and Curing**

- After compaction the roadway surface shall be treated with a light application of water, and rolled with pneumatic-tired rollers to create a close-knit texture. The finished layer shall be free from:
- Surface Laminations;
- Segregation of fine and course aggregate;
- Corrugations or any other defects that may adversely affect the performance of the layer.
- Tack coat shall not be applied until the moisture content of the recycled layer is at least 2 percent below the as placed moisture content.



### 6.8.3.11 Test Sections

- At the start of the project the contractor shall assemble all items of plant and equipment for the recycling operations and process a section of the roadway to:
- Demonstrate that the equipment and processes and produce recycled layers to meet the requirements specified in these provisions;
- Determine the effect on the grading of the recycled material by varying the forward speed of the recycling machine and the rotation of the pulverizing drum;
- Determine the sequence and manner of rolling necessary to obtain the minimum compaction requirements.
- The test section shall be at least 100m in length of a full lane-width.
- If the test section fails or if modifications are made to the methods, processes, equipment, and materials, additional test sections shall be performed in accordance with the requirements listed above before further work can be performed.

### 6.8.3.12 Field Quality Control

- Check the finished surface of the reclaimed base course to ensure it meets the following tolerances:

Grade: 6 mm maximum variation above design elevation.

6 mm maximum variation below design elevation.

- **When Tolerance Exceeded:**
  - Trim high areas and refinish surface to within tolerance.
  - Add recycled material to low areas, scarify and blend to full reclamation depth, re-compact to required density, and refinish surface.
  - **Density Tests:** If a density test result is less than the required density, the initial test result is discarded and three retests shall be performed on the area represented by the failed test. The average of the three retests shall represent the density of that area. If this average is less than the required density, the area shall be reworked to the full depth of the lift; the moisture content altered as necessary and re-compacted to the required density. If the area is not retested but is reworked and re-compacted the area shall be tested at normal testing frequencies.

### **6.8.3.13 Protection of Finished Work**

- Do not permit vehicular traffic over the recycled material until permitted by the Engineer.
- If the recycled material floods, drain immediately by natural flow or by pumping to catch basins, manholes, or ditches.
- Maintain protection of the recycled material until paved with hot-mix asphalt concrete. Repair recycled material if damaged.

**Table 6.8.4: Specifications for Premium Grade Asphalt Cements**

TEST CHARACTERISTICS	A.S.T.M. TEST METHOD	Premium Grades of Asphalt Cements					
		150-200 (A)			200-300 (A)		
Absolute Viscosity, 60°C, Pa - s	D2171	The viscosity and penetration values must fall within the area bounded by A-B-C-D-A plotted as straight lines on a full logarithmic plot (log-log), with the co-ordinates of the points as follows:			The viscosity and penetration values must fall within the area bounded by C-D-E-F-C plotted as straight lines on a full logarithmic plot (log-log), with the co-ordinates of the points as follows:		
Penetration, 25°C, 100g, 5s, dmm	D5	Pt.	Abs. Visc	Pen.	Pt.	Abs. Visc.	Pen.
		A	155	150	C	50	200
		B	70	150	D	92	200
		C	50	200	E	45	300
		D	92	200	F	26.5	300
Kinematic Viscosity, 135°C, sq. mm/s	D2170	The viscosity and penetration values must fall within the area bounded by A-B-C-D-A plotted as straight lines on a full logarithmic plot (log-log), with the co-ordinates of the points as follows:			The viscosity and penetration values must fall within the area bounded by C-D-E-F-C plotted as straight lines on a full logarithmic plot (log-log), with the co-ordinates of the points as follows:		
Penetration, 25°C, 100g, 5s, dmm	D5	Pt.	Kin. Visc	Pen.	Pt.	Kin. Visc	Pen.
		A	360	150	C	205	200
		B	225	150	D	285	200
		C	205	200	E	205	300
		D	285	200	F	150	300
Flash Point, Cleveland Open Cup, °C minimum	D92	205			175		
Solubility in Trichlorethelene, % minimum	D2042	99.5			99.5		
Tests on Residue from Thin Film Oven Test: Ratio of Absolute Viscosity of Residue from Thin-Film Oven Test to Original Absolute Viscosity, maximum:	D1754	4.0			4.0		
	D2171						
Ductility, 25°C, cm, maximum	D113	100			-		
Ductility, 15.6°C, cm, minimum		-			100		

**General Requirement:**

- The asphalt shall be prepared by the refining of petroleum. It shall be uniform in character and shall not foam when heated to 175°C.
- The temperature at delivery to the site shall be between 170°C and 190°C.

Chart 6.8.1: Specifications for Asphalt Cement Absolute Viscosity

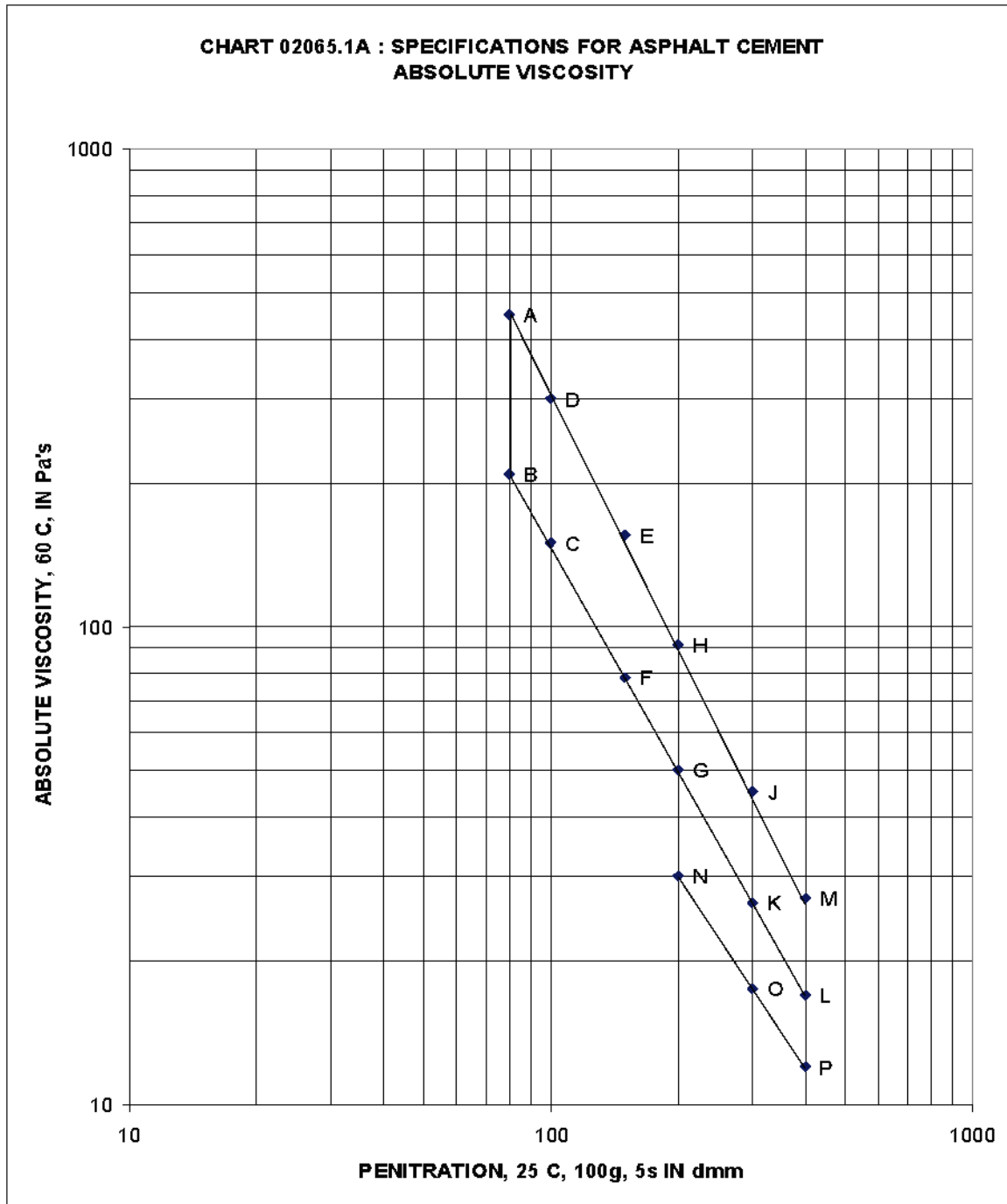

Chart 6.8.2: Specifications for Asphalt Cement Absolute Viscosity

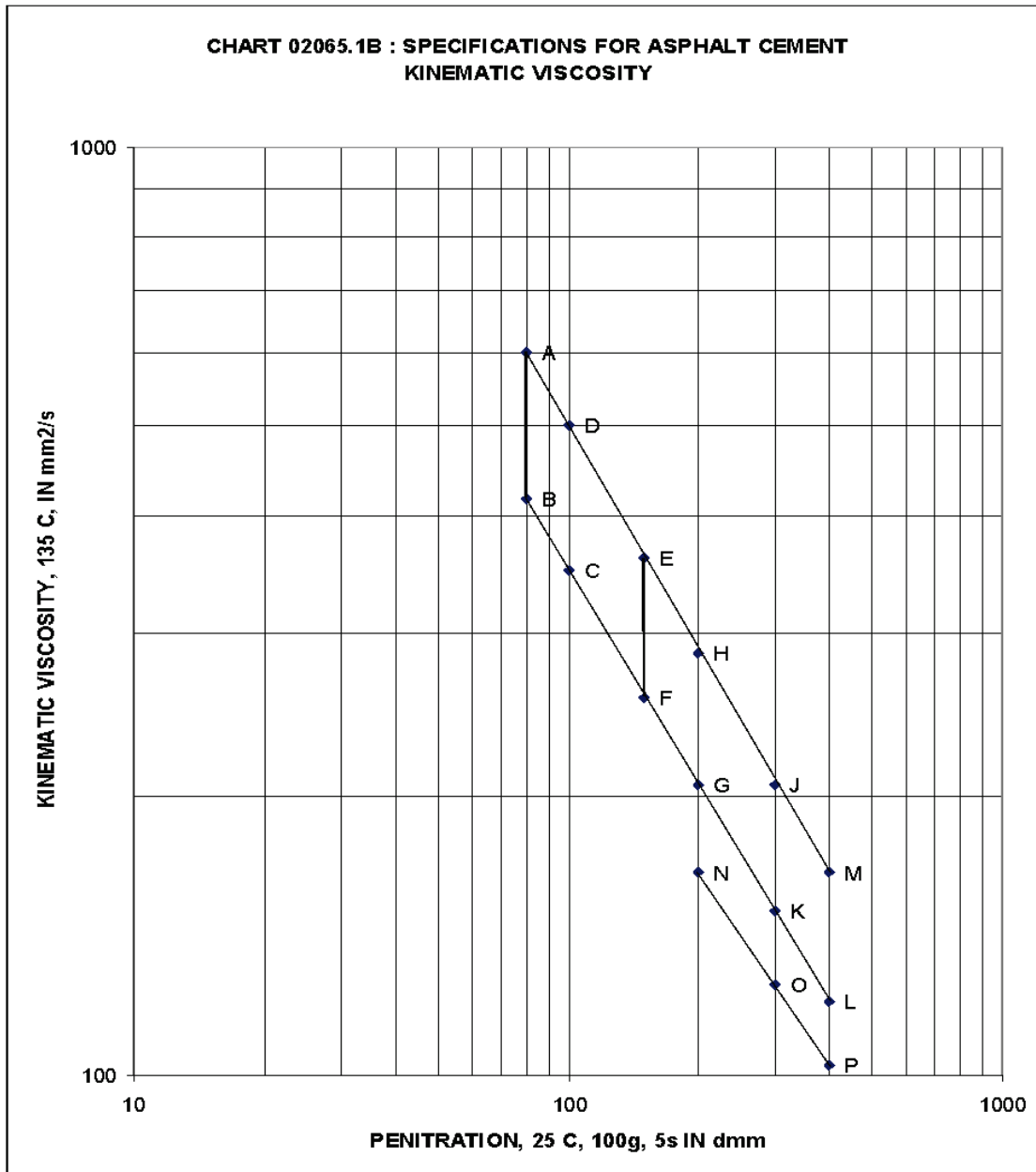

Table 6.8.5: AASHTO M320 Table 2

Performance Grade	PG 46					PG 52					PG 58					PG 64					
	34	40	46	10	16	22	28	34	40	46	16	22	28	34	40	10	16	22	28	34	40
Average 7-day max pavement design temperature, °C <sup>a</sup>	<46																				
Min pavement design temperature, °C <sup>a</sup>	>-34																				
Original Binder																					
Flash point temp, T 48, min °C	230																				
Viscosity, T 316: <sup>b</sup> Max 3 Pa•s <sup>m</sup> test temp, °C	135																				
Dynamic shear, T 315: <sup>c</sup> G*/sinδ <sup>e</sup> , min 1.00 kPa test temp @ 10 rad/s, °C	46																				
Mass change, <sup>f</sup> max, percent	1.00																				
Rolling Thin-Film Oven Residue (T 240)																					
Dynamic shear, T 315: G*/sinδ <sup>e</sup> , min 2.20 kPa test temp @ 10 rad/s, °C	46																				
Pressurized Aging Vessel Residue (R 28)																					
PAV again temperature, °C <sup>d</sup>	90																				
Dynamic shear, T 315: G*/sinδ <sup>e</sup> , max 5000 kPa test temp @ 10 rad/s, °C	10	7	4	25	22	19	16	13	10	7	25	22	19	16	13	31	28	25	22	19	16
Critical low cracking temp, R 49: <sup>f</sup> Critical cracking temp determined by R 49, test temp, °C	-24	-30	-36	0	-6	-12	-18	-24	-30	-36	-6	-12	-18	-24	-30	0	-6	-12	-18	-24	-30

- Notes:
- a. Pavement temperatures are estimated from air temperatures using an algorithm contained in the LTPP Bind program, may be provided by the specifying agency, or by following the procedures as outlined in M 323 and R35.
  - b. This requirement may be waived at the discretion of the specifying agency if the supplier warrants that the asphalt binder can be adequately pumped and mixed at temperatures that meet all applicable safety standards.
  - c. For quality control of unmodified asphalt binder production, measurement of the viscosity of the original asphalt binder may be used to supplement dynamic shear measurements of G\*/sinδ at test temperatures where the asphalt is a Newtonian fluid.
  - d. G\*/sinδ = high temperature stiffness and G\* sinδ = intermediate temperature stiffness.
  - e. The mass change shall be less than 1.00 percent for either a positive (mass gain) or negative (mass loss) change.
  - f. The PAV aging temperature is based on anticipated climatic conditions and is one of three temperatures, 90°C for climates requiring PG 52-xx and below, 100°C for climates requiring PG 58-xx to PG 70-xx, or 110°C for climates requiring PG 76-xx and above. Normally, the PAV aging temperature is specified based on the PG grade. However, when the binder is being used in a different climate due to grade bumping or needed for softer binder due to blending, the PAV aging temperature may be specified as 100°C when used in climates requiring PG 58-xx to PG70-xx, or 110°C when used in climates requiring PG 76-xx and above.
  - g. For verification of grade, at a minimum perform T 313 at the test temperature and at the test temperature minus 6°C and T 314 at the test temperature. Testing at additional temperatures for T 313 may be necessary if 300 MPa is not bracketed at the initial two test temperatures. Compare the failure stress from T 314 to the calculated induced thermal stress per R 49. If the failure stress exceeds the induced thermal stress, the asphalt binder is deemed a "PASS" at the specification temperature.

Table 6.8.6: AASHTO M320 Table 2 (continued)

Performance Grade	PG 70					PG 76					PG 82						
	10	16	22	28	34	40	10	16	22	28	34	40	10	16	22	28	34
Average 7-day max pavement design temperature, °C <sup>a</sup>	<70																
Min pavement design temperature, °C <sup>a</sup>	<76																
Min pavement design temperature, °C <sup>a</sup>	>-10	>-16	>-22	>-28	>-34	>-40	>-10	>-16	>-22	>-28	>-34	>-40	>-10	>-16	>-22	>-28	>-34
<b>Original Binder</b>																	
Flash point temp, T 48, min °C	230																
Viscosity, T 316: <sup>b</sup> Max 3 Pa*sm test temp, °C	135																
Dynamic shear, T 315: <sup>c</sup> G*/sinδ <sup>d</sup> , min 1.00 kPa test temp @ 10 rad/s, °C	76																
<b>Rolling Thin-Film Oven Residue (T 240)</b>																	
Mass change, <sup>e</sup> max, percent	1.00																
Dynamic shear, T 315: G*/sinδ <sup>d</sup> , min 2.20 kPa test temp @ 10 rad/s, °C	76																
<b>Pressurized Aging Vessel Residue (R 28)</b>																	
PAV again temperature, °C <sup>f</sup>	100 (110)																
Dynamic shear, T 315: G*/sinδ <sup>d</sup> , max 5000 kPa test temp @ 10 rad/s, °C	34	31	28	25	22	19	37	34	31	28	25	40	37	34	31	28	28
Critical low cracking temp, R 49: <sup>g</sup> Critical cracking temp determined by R 49, test temp, °C	0	-6	-12	-18	-24	-30	0	-6	-12	-18	-24	0	-6	-12	-18	-24	-24

Notes:

- a. Pavement temperatures are estimated from air temperatures using an algorithm contained in the LTPP Bind program, may be provided by the specifying agency, or by following the procedures as outlined in M 323 and R35.
- b. This requirement may be waived at the discretion of the specifying agency if the supplier warrants that the asphalt binder can be adequately pumped and mixed at temperatures that meet all applicable safety standards.
- c. For quality control of unmodified asphalt binder production, measurement of the viscosity of the original asphalt binder may be used to supplement dynamic shear measurements of G\*/sinδ at test temperatures where the asphalt is a Newtonian fluid.
- d. G\*/sinδ = high temperature stiffness and G\* sinδ = intermediate temperature stiffness.
- e. The mass change shall be less than 1.00 percent for either a positive (mass gain) or negative (mass loss) change.
- f. The PAV aging temperature is based on anticipated climatic conditions and is one of three temperatures, 90°C for climates requiring PG 52-xx and below, 100°C for climates requiring PG 58-xx to PG 70-xx, or 110°C for climates requiring PG 76-xx and above. Normally, the PAV aging temperature is specified based on the PG grade. However, when the binder is being used in a different climate due to grade bumping or needed for softer binder due to blending, the PAV aging temperature may be specified as 100°C when used in climates requiring PG 58-xx to PG70-xx, or 110°C when used in climates requiring PG 76-xx and above.
- g. For verification of grade, at a minimum perform T 313 at the test temperature and at the test temperature minus 6°C and T 314 at the test temperature. Testing at additional temperatures for T 313 may be necessary if 300 MPa is not bracketed at the initial two test temperatures. Compare the failure stress from T 314 to the calculated induced thermal stress per R 49. If the failure stress exceeds the induced thermal stress, the asphalt binder is deemed a "PASS" at the specification temperature.

## 6.9 PAVEMENT CRACK SEALING

### 6.9.1 General

#### 6.9.1.1 Content

This section includes the routing, cleaning and sealing cracks and joints in asphalt pavement.

#### 6.9.1.2 Submittals

Submit crack or joint sealant manufacturer's product data to the Technical Services Section, Integrated Infrastructure Services at least 7 days prior to use.

#### 6.9.1.3 Quality Assurance

- The quality assurance laboratory will perform the following to determine acceptability of the work and end product:
  - Evaluate rout width, depth and centering along the crack.
  - Check sealant temperatures at the heating kettle and at application.
  - Test sealant penetration and flow.
- Definitions: For purposes of evaluating rout width, depth and centering accuracy, a lot is equal to a day's production of a sealing crew, or a portion thereof as designated by the Engineer. Each lot will be represented by a series of measurements at a minimum of 40 points in the lot. The compliance\_percentage each for width/depth ratio and centering accuracy will be the number of points meeting the specified tolerances divided by the total number of points, expressed in percent.
- For each day's production of a sealing crew, a sample of molten sealant will be taken and tested for penetration and flow.

### 6.9.2 Products

#### 6.9.2.1 Materials

- **Crack or Joint Sealant:** hot-poured rubberized asphalt sealant conforming to physical requirements in ASTM D1190. The sole acceptable brand

#### 6.9.2.2 Equipment

- **Mechanical Router:** portable and capable of cutting the pavement surface in a single pass to a width of 40 mm and to a depth of 8 mm. The Contractor shall demonstrate that the router is capable of following meandering cracks and keeping the crack centred within  $\pm 8$  mm of the centre of rout.



- **Compressed Air Lance:** capable of blowing dry, oil-free compressed air at a minimum line pressure of 690 kPa.
- **Melting Kettle:** mobile, rubber tired, double jacketed oil bath kettle, using high flash point oil heat transfer medium; with an automatic agitator to continuously stir the sealant during heating; with 2 thermocouple devices to monitor the temperatures of the heating oil and the sealant with temperature indicators which can be read by the Engineer at road level. The temperature readings shall be in Celsius degrees with an accuracy of  $\pm 2\%$ . The use of a direct fired kettle is not permitted.
- **Sealant Dispenser:** wand fitted with the proper size tip and connected to a low pressure pump from the melting kettle.

### 6.9.3 Execution

#### 6.9.3.1 Routing and Sealant Preparation

- Before routing, sweep designated pavement area clean of dirt accumulations to expose cracks and joints.
- Rout cracks and joints that are 2 mm to 25 mm wide, unless directed otherwise by the Engineer. Do not rout cracks in areas with severe block cracking.
- Rout crack or joint to a width of 40 mm and a depth of 8 mm.
- Sealant Preparation: Slowly melt the sealant in the heating kettle with continuous agitation. Do not add any other material to the sealing compound. The preferred temperature range for sealant heating is 190°C to 200°C and sealant shall not be heated to temperatures greater than 205°C at any time. Discard overheated or burnt sealant.

#### 6.9.3.2 Sealant Application

- After routing, air-blow loose debris to the edge of the road away from the area to be sealed to ensure that fresh sealant is not contaminated. Sealed cracks that are contaminated with routing debris will be rejected.
- Immediately before pouring the sealant, use the compressed air lance to blow any remaining dust and loose debris from the routed groove.
- Carefully apply the sealant with the tip of wand placed close to the bottom of the routed groove to ensure uniform application. Fill the groove only to the extent that when cooled the sealant is flush with the adjacent pavement surface within  $\pm 2$  mm.
- Use traffic barriers to prevent tracking of uncured sealant. Newly sealed cracks may be dusted with an approved material only when permitted by the Engineer. Do not open the road to traffic until the sealant has properly set up and no danger of damage to the sealant exists, a minimum of 20 minutes after sealant placement.

- Allow the sealant to set and cure for 48 hours after application prior to cleanup sweeping, unless permitted otherwise by the Engineer.

### 6.9.3.3 Field Quality Control

- **Rout Cross-Section Dimensions:**
  - Width: 40 mm
  - Depth: 8 mm
  - Width/Depth Ratio: 4.5 to 5.5
- **Non-compliance:** A lot with a compliance percentage of less than 90% for width/depth ratio shall be subject to a pay factor equal to the compliance percentage.
- **Rout Centering along Crack**

Centre of crack shall not be more than 8 mm from the centre of rout.

Non-compliance: A lot with a compliance percentage of less than 80% shall be subject to a pay factor equal to 1.25 multiplied by the compliance percentage for centering.
- **Heating Temperature**

At no point in the heating process shall the sealant temperature exceed 205°C. Discard all overheated or burnt sealant.
- **Application Temperature**

The sealant temperature at the time of application shall not be less than 185°C. If the application temperature is less than 185°C, suspend application until sealant temperatures are corrected in the kettle without overheating.
- **Sealant Quality**
  - When tested according to ASTM D5329, the sealant shall have the following properties:
    - Penetration at 25°C: 90 maximum
    - Flow at 60°C: 5 mm maximum
    - Non-compliance: If the maximum penetration is exceeded, the day's production represented by the failed test shall be subject to the following pay factors:

**Table 6.9.1: Excess Penetration Pay Factor**

Penetration at 25°C	Pay Factor
91-92	100.0%
93-94	99.4%
95-96	98.6%
97-98	97.2%
99-100	95.6%
101-102	93.5%
103-104	91.1%
105-106	88.4%
107-108	85.3%
109-110	80.0%
>110	Reject

The pay factors shall be individually applied, where applicable, to the contract price.

#### 6.9.3.4 Rejected Work

- Sealed cracks shall be rejected if there is evidence of poor workmanship or obvious defects, including:
  - Routed crack not filled completely
  - Lack of bond to sides of rout
  - Excessive debris or moisture in the rout
  - Contamination of the sealant
  - Routed crack not filled flush within  $\pm 2$  mm
  - Tracking of uncured sealant
  - Excessive rounding or spalling of the routed edges

- Repair of Rejected Work

Repair rejected sealed cracks by removing the sealant and resealing the cracks, to the Engineer's satisfaction and at no further cost to the City.

#### 6.9.3.5 Warranty

- Completed and accepted pavement crack sealing shall be guaranteed for a one year period following the date of the Construction Completion Certificate.
- If, during the warranty period, there is evidence of bond failure or of water or material ingress through the crack, remove the sealant, clean the crack and reseal, to the Engineer's satisfaction.

### **6.9.3.6 Cleanup and Opening to Traffic**

- Remove excess material and clean up soiled pavement and concrete surfaces within 48 hours after the sealant has properly cured.
- Keep traffic off the newly sealed pavement until the sealant has properly set up and is in no danger of being damaged or pulled out by traffic.
- Repair damage to the sealant caused by traffic and by the Contractor's operations.

## 6.10 BRIDGE DECK ASPHALT SURFACING

### 6.10.1 General

#### 6.10.1.1 Content

Provide all labour, materials, products and equipment required to remove existing asphalt from bridge deck and supply and place a polymer modified asphalt membrane/mastic surface wearing course to the bridge deck and approaches.

#### 6.10.1.2 Related Sections

- SGC Hot-Mix Asphalt Concrete Section 6.1
- Liquid Asphalt Coats Section 6.7
- SGC Hot-Mix Asphalt Paving Section 6.3

#### 6.10.1.3 Quality Assurance

- **Inspection and testing**
  - All products and workmanship will be inspected by the Engineer. The Technical Services Section, Integrated Infrastructure Services, City of Edmonton (ESS) will conduct plant inspection and materials sampling and testing described in the following paragraphs.
  - The Contractor shall notify the Engineer and TSS in ample time to permit inspection and testing.
  - The Contractor shall co-operate with the Engineer and TSS on the inspection of materials and sampling.
  - The Contractor shall not cover any work before inspection and testing unless authorized by the Engineer, in writing.
  - The Contractor shall remove and replace or repair defective products or work that fails to meet the specified requirements as directed by the Engineer, at no cost to the City.
- **Asphalt Plant**

Inspections will be conducted at least once during production to check plant calibrations, plant operation, production settings, temperatures, and materials handling. Samples of materials and mixture may be taken and tested.

- **Asphalt Cement**

- Quality assurance sampling and testing of the asphalt cement shall be performed by the TSS, to verify compliance to the specification. A sample shall be taken at random during paving operations on City projects from a load(s) delivered to the Contractor's asphalt plant at least twice a month or as otherwise determined by the TSS. It is the contractor's responsibility to inform the TSS of the delivery of asphalt Cement to their facility for sampling.
- If non-complying material is identified, the paving program may be suspended for 24 hours, as directed by the Engineer, during which time the Contractor, the Engineer, and TSS will meet to determine the impact of the non-compliance, and specify the necessary remedial action to be taken by the Contractor. Remedial action shall be either acceptance, acceptance at a pay adjustment, or removal and replacement at no cost to the City. If suspended, the paving program shall only continue upon written authorization by TSS.
- Asphalt cement identified to be in non-compliance shall not be shipped to a project. SGC hot-mix mixed and placed with identified non-complying asphalt cement shall be removed and replaced, as directed by the Engineer with complying material by the Contractor at no cost to the City.

- **Production Mix Analysis**

- Full mix sample testing will be conducted at a minimum frequency of one test, for each day's production. Three briquettes will be made and tested for Marshall Properties and Maximum Theoretical Density, and three briquettes will be made and tested for permeability.
- The determination of the asphalt cement content will utilize the asphalt ignition oven correction factor, as determined by the ESS.
- QA will conduct nuclear density testing on the compacted mat at locations which represent 1,000 m<sup>2</sup>
- Basis of Acceptance: Bridge deck hot-mix pavement compaction will be accepted based on the ratio (in percent) of the results obtained from the calibrated nuclear densometer density to the MTD. If results are obtained from a mat where no MTD are available, acceptance will be based on the ratio of nuclear densometer density to the average MTD for that day's production.

- **Job Mix Formula**

- The QA will test a trial batch of the Bridge Deck hot-mix job mix formula to verify the mix design. The mix design and job mix formula will not be approved by the Engineer until successful results are obtained by the TSS.

- The QA will use the mix provided in the Trail Batch to produce specimens with which to calibrate the nuclear densometer for performing field density determinations.

#### **6.10.1.4 Quality Control**

##### ○ **General**

The Contractor is responsible for quality control throughout all stages of the SGC hot-mix production and placement including the aggregates, asphalt cement, and any other materials used in the mix. The Contractor shall utilize a qualified testing laboratory to undertake the quality control sampling and testing to determine and monitor the properties of the materials being produced and used on the project.

##### ○ **Sampling and Testing**

The Contractor shall follow the sampling and testing methods and frequencies indicated in their quality control plan and/or as accepted or modified by TSS.

##### ○ **Curing Requirement**

No traffic shall be allowed on newly placed asphalt until densities have been reached and surface has cooled down to 32° C.

##### ○ **Existing Asphalt Depth**

Asphalt depth data is described in the Special Provisions. No additional payments will be made for removal of asphalt below indicated depths.

##### ○ **Haul Routes**

- Haul routes shall be approved by the Engineer and in accordance with the General Conditions.
- Ensure that all vehicles used are equipped to prevent spilling or leaking of any part of the load.

##### ○ **Equipment**

- Pavers: mechanical automatic grade controlled self-powered pavers capable of spreading mix within specified tolerance, true to line, grade and crown indicated.
- Rollers: sufficient number of rollers of type and weight to obtain specified density of compacted mix. Vibrators on vibratory rollers shall NOT be activated. The Engineer, at his sole discretion, may allow the Contractor to activate vibrators on vibratory rollers not exceeding 5 tonnes in weight.

- **Haul Trucks**

- Haul trucks: of adequate size, speed and condition to ensure orderly and continuous operation and as follows:
- Clean, tight, smooth sided boxes.
- Covers of sufficient size and weight to completely cover and protect asphalt mix when truck fully loaded.
- In cool weather or for long hauls, insulate entire contact area of each truck box.

- **Hand Tools**

- Lutes or rakes with covered teeth shall be used during spreading and finishing operations.
- Tamping irons having mass not less than 13 kg and a bearing area not exceeding 310 cm<sup>2</sup> for compacting material along curbs, gutters and other structures inaccessible to roller. Mechanical compaction equipment, when approved by the Engineer, may be used instead of tamping irons.
- Straight edges, 4.5 m in length, to test finished surface.

- **Longitudinal Joints**

If application of the wearing course is to be stopped and delayed for 6 hours or more, the temperature of the joint material cannot be maintained at a minimum of 115 °C and/or the edge of the longitudinal joint has been deformed due to vehicles driven over, carefully roll the edge of the mat. Prior to placement of the adjoining mat, trim off the rolled material from the first mat to a width of 150mm resulting in a clean vertical face to the full depth of the mat and paint with a tack coat sealer before placing the adjacent mat.

## **6.10.2 Products**

### **6.10.2.1 Materials for Polymer Modified Asphalt**

- **Asphalt Cement:** Polymer Modified Bridge Mastic, supplied by Husky Oil Ltd., meeting the requirements given in Table A. No alternatives will be allowed.
- Aggregates shall be approved by the Engineer and shall meet the gradation requirements given in Table B.
- **Fine aggregate:** That fraction of the total aggregate passing the 5 000 µm sieve. Fine aggregate shall contain a minimum 75 percent manufactured or crushed fines. The total



percent of manufactured fines in a mix is taken as the percentage of manufactured fines in the minus 5 000  $\mu\text{m}$  sieve fraction of the total combined aggregate.

- **Coarse aggregate:** That fraction of the total aggregate retained on the 5 000  $\mu\text{m}$  sieve. A minimum of 75% of the coarse aggregate particles shall have at least two crushed faces.
- **Tack coat:** Cutback Asphalt, grade MC-30 or approved alternate, subject to approval by the Engineer. Tack coat utilizing water as a carrier will not be allowed.

#### 6.10.2.2 Mix Properties for Polymer Modified Asphalt

- Submit a mix design carried out by a qualified laboratory, to TSS for review a minimum of 4 weeks prior to commencement of the work.
- The mix design shall include:
  - Legal description of all aggregate sources;
  - Individual aggregate gradations;
  - Water absorption of the individual aggregates and the combined aggregates;
  - Aggregate blend;
  - Combined aggregate gradation;
  - Bulk specific gravity of individual aggregates and mineral filler;
  - Based on the individual aggregate results, the calculated bulk specific gravity of the combined aggregates;
  - A minimum of five individual and separate asphalt cement contents must be used in the mix design and each individual asphalt cement content must be separated by a minimum of 0.40 to a maximum of 0.60 percent (by dry weight of aggregate);
  - Graph of mix's Theoretical Maximum Density (MTD) versus asphalt cement content (by total mix) reported to two significant digits;
  - All other graphs used in the mix design (by total mix);
  - Individual mix property results are to be plotted and a second order polynomial graph drawn through the individual data points.
  - Recommended initial asphalt cement content and associated mix parameters;
  - Asphalt cement absorption of the combined aggregates;
  - Ignition oven asphalt cement content correction factor;
  - The results of permeability testing carried out on briquettes at the design binder content.
- Mix design for single lifts shall meet the requirements given in Table C for a laboratory compacted mix mixed at 180°C and compacted at 168°C with 50 blows from a mechanical compactor. Mix temperature at the plant shall NOT exceed 185 °C.

- Mix design for membrane in multiple lifts shall meet the requirements given in Table D for a laboratory compacted mix mixed at 180°C and compacted at 168°C with 50 blows from a mechanical compactor. Mix temperature at the plant shall NOT exceed 185 °C.
- Mix design for overlays in multiple lifts shall meet the requirements given in Table E for a laboratory compacted mix mixed at 180°C and compacted at 168°C with 50 blows from a mechanical compactor. Mix temperature at the plant shall NOT exceed 185 °C.
- Allowable variations in aggregate gradation between the job mix and the approved mix design:
  - 3% on material retained on the 160 µm and coarser sieve.
  - 1% on material retained on the 80 µm sieve.

### **6.10.2.3 Tolerances**

- **Marshall Tolerances**
  - The tolerances for the required Marshall properties for quality assurance testing are detailed in Tables C, D, or E depending on the mix designation.
- **Permeability Tolerance**
  - Permeability testing shall be carried out in accordance with ASTM D 5084-90 on three briquettes molded at the time of Marshall Field sample preparation.
  - If the average permeability of the tests of the three samples does not meet the permeability specified, the Contractor shall remove and replace the deficient areas at no cost to the Owner. The replacement of the materials shall be performed in accordance with these specifications.
- **Density Tolerance**
  - Required Density: Each mat of hot-mix placed shall be compacted to a minimum of 94 Percent of Maximum Theoretical Density (MTD), or as otherwise indicated in the contract Special Provisions.
  - Deficient Density: If the average density as determined through use of the nuclear densometer is below specified, the represented area of mat may be accepted subject to a pay factor according to Table 6.3.5 to be applied to the price of the quantity of hot-mix in that mat area
- **Thickness Tolerance**
  - As detailed in Section 6.3 SGC Hot-Mix Asphalt Paving

### 6.10.2.4 Field Quality Control

- **Smoothness Tolerances**
  - Maximum variation under 4.5 m straight edge as follows:
  - Longitudinal in direction of travel: 6 mm.
  - Transverse to direction of travel: 6 mm.
  - (Straight crossfall)
- - Grade: +/- 6 mm maximum variation from designated grade elevations.
  - Texture: The finished surface shall have a tightly knit texture free of visible signs of poor workmanship including but not limited to:
  - Segregation, waves, hairline cracks, roller marks or other unevenness.
  - If the finished surface of the mat does not comply with the above requirements, the Contractor shall remove and replace the deficient areas at no cost to the Owner. The replacement of the mat shall be performed in accordance with these specifications.
- **Plant and Mixing Requirements**
  - Refer to City of Edmonton Specification Section 6.1 – SGC Hot-Mix Asphalt Concrete.

### 6.10.3 Execution

#### 6.10.3.1 Removal of Existing Deck Materials

- The existing deck materials shall be removed through use of milling equipment. A minimum of 90% of the area of the concrete bridge deck must be visible after the removal operation. Any materials left in place shall not exceed 10 mm in height. Remove all unbounded, loose materials by scraping and sandblasting.
- Place protection in all expansion joints prior to the removal operation. Protection to be left in place until after paving is completed.
- Clean bridge surface after removal operation is complete and blow dry entire concrete deck.
- Temporary ramping is to be placed at all manholes and expansion joint and left in place until just prior to paving.

### 6.10.3.2 Site Preparation

- The Contractor must provide, at his expense, a satisfactory working area at both ends of the bridge to maneuver trucks and clean truck tires, paving equipment, including the spreader, steel rollers and pneumatic rollers, etc., using concrete, asphaltic concrete or other material acceptable to the Engineer.
- Blow dry the deck using min. of 125 cubic feet per minute (CFM) compressed air to ensure that no mud, dirt, standing water, or surface moisture is left in place.
- Depressions greater than 10 mm in depth shall be brought level with surrounding areas by manual application and tamping of the mastic pavement mixture.
- Apply a tack coat of MC-30 or approved alternate at a rate of 0.3 liters per square meter. Complete drying of the tack coat is required before paving can commence.
- Adjacent structures and appurtenances shall not be spattered by the tack coat. The Contractor shall remove any spattering and make good the affected surface to the satisfaction of the Engineer at no cost to the Owner.
- Apply a uniform coating of MC-30 or approved alternate along gutter lines, adjacent to expansion joints and around drainpipes using a brush or squeegee. Vertical faces of curbs and other appurtenances shall be brush coated with a rubberized asphaltic compound such as Bakor 570-05 (CR-10) rubber asphalt edge sealer or approved equal.
- The tack coat shall be applied only when the surface to be treated is dry, when the weather is not foggy or rainy, and when the surface temperature is above 15°C.
- The tack coat shall be applied by means of a self-propelled pressure bituminous material distributor subject to the approval of the Engineer.
- The tack coat shall be applied in a single application.
- The Contractor must be responsible for accidents or damage resulting from the use of excessive temperatures and shall replace, at no expense to the Owner, any material destroyed.
- Areas missed by the distributor or inaccessible to the distributor, shall be treated using hand spray prior to tacking section adjacent.
- No traffic shall be allowed on the tack coat until the material is fully cured and approved by Engineer.

### 6.10.3.3 Mix Delivery

- Transport mix to the job site in vehicles cleaned of foreign material.
- Paint or spray truck beds with light oil, limewater, soap or detergent solution at least once a day or as required. Elevate truck bed and thoroughly drain. No excess solution will be permitted.
- Schedule delivery of material for placing in daylight, unless the Engineer approves artificial light.
- Deliver material to paver at a uniform rate in an amount within capacity of paving and compacting equipment.
- Deliver loads continuously in covered vehicles and immediately spread and compact.
- Loaded or empty trucks shall not be turned around on the bridge deck.
- Ensure vehicle tires are clean of deleterious material prior to driving onto the bridge deck.
- Maintain asphalt within truck at a temperature greater than 160°C. The load will be rejected by the Engineer or his representative if the asphalt temperature of the truckload falls below 160°C.

### 6.10.3.4 Placing

- Placing - Single Lift
  - Standard paving machines shall be adjusted to place a continuous mat of asphalt to match existing thickness.
  - Place asphalt mixtures only when air temperature is above 12°C and deck temperature is above 10°C. Secondary rolling will be completed before the temperature of the mat falls below 90°C.
  - Coverage of the single lift membrane/wearing course pavement shall be a minimum of no less than 45 mm pavement thickness in any area, and no more than 80 mm. Some adjustment of mat thickness may be required to match the elevations of existing features.
  - The Engineer may suspend spreading if segregation of mix material occurs until such time as the cause can be determined and corrected.
- Placing - Multiple Lifts
  - Membrane Placement

Standard paving machines shall be adjusted to place a continuous mat of 25 mm nominal thickness.

The thickness of the mastic membrane shall at no time be less than 20 mm.

Place asphalt mixtures only when air temperature is above 12°C and deck temperature is above 10°C. Secondary rolling will be completed before the temperature of the mat falls below 90°C.

- **Overlay Placement**

Surface course asphalt shall be applied at a minimum thickness of 75 mm or as indicated on the drawings. Some adjustment of mat thickness may be required to match elevations of existing features.

If application of the wearing course is delayed for more than 48 hours, or if construction traffic creates a visible coating of dust or dirt, a tack coat of emulsion, approved for standard pavement construction, shall be applied. Use of tack coat on top of the membrane pavement shall be subject to the approval of the Engineer.

Longitudinal joints in the surface course shall be offset 300 mm lateral distance, or greater, from the longitudinal joint in the underlying membrane mix.

The Engineer may suspend spreading if segregation of mix material occurs until such time as the cause can be determined and corrected.

### **6.10.3.5 Compacting**

- Asphaltic concrete shall be compacted to not less than 94 percent of Maximum Theoretical Density (MTD).
- Steel and pneumatic-tired rollers shall be kept slightly moistened by water. Steel rollers shall be equipped with scrapers. Pneumatic tire rollers shall be equipped skirting. Excessive use of water will not be permitted.
- The roller shall not be driven onto or off the mat over the longitudinal edge of mat.
- Do not turn rollers around on the deck. The roller must run off the deck to stop and turn.
- The line of rolling shall not suddenly be changed or the direction of rolling suddenly reversed. Any pronounced change or direction shall be made on stable material.
- Rollers shall not be permitted to stand on the mat.

**Table A**

Property	Units	ASTM No.	Minimum	Maximum
<b>LOW SERVICE TEMPERATURE CHARACTERISTICS</b>				
Stiffness Modulus @ -20°C (Loading Time 500sec) (Recommended Method)	Pa			$5 \cdot 10^7$
Pen @ 0°C, 200g 60sec. (Alternate Method Only)	Dmm	D5	30	
<b>HIGH SERVICE TEMPERATURE CHARACTERISTICS</b>				
Viscosity @ 60°C (Shear Rate $5 \cdot 10^{-2} \text{s}^{-1}$ )	Pa · s		600	
Elastic Behavior (@ Room Temperature)				
Toughness	J	Benson Test (or Equivalent)	10	
Tenacity	J	Benson Test (or Equivalent)	8	
<b>TECHNICAL CHARACTERISTICS</b>				
Kinematic Viscosity @ 135°C	mm <sup>2</sup> /s	D2170		3000
Flashpoint	°C	D92	230	
<b>AGING CHARACTERISTICS</b>				
(Test After Thin Film Oven Test)				
Weight Loss	%	D1754		1.0
Aging Index				4.0

$$\text{Aging Index} = \frac{\text{Viscosity @ 60 °C (Shear rate } 5 \cdot 10^{-2} \text{s}^{-1} \text{) after TEOT}}{\text{Viscosity @ 60 °C (Shear rate } 5 \cdot 10^{-2} \text{s}^{-1} \text{) before aging}}$$

**Table B**

Sieve Size (µm)	% Passing
10 000	100
5 000	90 – 95
2 500	70 – 76
160	8 – 16
80	6 – 10

**Table C**

Property	Limit	ASTM Designation
Binder Content (%)	8.5 min.	D2172/ATT-12 Part II
Marshall Stability (N)	6000 min.	D1559
Flow (250 µm)	20 max.	D1559
VMA (%)	14 min.	
Air Voids (%)	3 – 5	
Permeability @ 70 kPa (cm/s)	10 <sup>-7</sup> max.	D5084-90
Film Thickness (microns)	8.0 min.	

**Table D**

Property	Limit	ASTM Designation
Binder Content (%)	9.5 min.	D2172/ATT-12 Part II
Marshall Stability (N)	5200 min.	D1559
Flow (250 µm)	20 max.	D1559
VMA (%)	18 min.	
Air Voids (%)	3 - 5	
Permeability @ 70 kPa (cm/s)	10 <sup>-7</sup> max.	D5084-90
Film Thickness (microns)	8.0 min.	



**Table E**

Property	Limit	ASTM Designation
Binder Content (%)	6.5 ± 0.3%	D2172/ATT-12 Part II
Marshall Stability (N)	7000 min.	D1559
Flow (250 μm)	20 max.	D1559
VMA (%)	14 min.	
Air Voids (%)	3 – 5	
Permeability @ 70 kPa (cm/s)	10 <sup>-7</sup> max.	D5084-90
Film Thickness (microns)	7.0 min.	

## 6.11 RECYCLED ASPHALT PAVING

### 6.11.1 General

#### 6.11.1.1 Content

This section includes the reclaiming existing asphalt pavement, the design and production of recycled asphalt hot-mix and the placing recycled asphalt hot-mix.

#### 6.11.1.2 Related Sections

- SGC Hot-Mix Asphalt Concrete Section 6.1
- SGC Hot-Mix Asphalt Paving Section 6.3
- Pavement Cold Milling Section 6.6

#### 6.11.1.3 Quality Assurance

- To Section 6.1 – SGC Hot-Mix Asphalt Concrete.

### 6.11.2 Products

#### 6.11.2.1 Materials

- **Reclaimed Asphalt Pavement (RAP):** Rap is salvaged, milled, pulverized, broken, or crushed asphalt pavement removed from an existing pavement.
- **Recycled Asphalt Shingles (RAS):** Pre-consumer or post-consumer shingles that have been processed, sized, and are ready for incorporation into a hot mix Asphalt mixture.
- **Virgin Aggregate:** New aggregate to Section 6.1 – SGC Hot-Mix Asphalt Concrete.
- **Aggregate in Recycled Asphalt Mix:** to Section 6.1 – SGC Hot-Mix Asphalt Concrete modified as follows:

Mix Type:	20mm – B	10mm – HT	10mm – LT
Designation 1 class:	20	10.0	10.0
Sieve Size (µm)	Total Passing by Mass		
160	9-16	7-16	8-16
80	4-9	4-9	4-9

- **Asphalt Cement:** The extracted blended asphalt cement shall meet the PG requirements as detailed in Section 6.1 – SGC Hot-Mix Asphalt Concrete.

### 6.11.2.2 Mix Design and Proportioning

- Submit a recycled asphalt mix design to Section 6.1 – SGC Hot-Mix Asphalt Concrete for the specified mix type based on the following maximum RAP, RAS, or combination of RAP and RAS content:

**Table 6.11.1: Maximum RAP and RAS Content per Recycled Asphalt Mix Design**

Mix type:	20mm - B	10mm - HT	10mm - LT
Maximum RAP content if only using RAP in the mix (% by mass of total mix)	25	10	20
Maximum RAS content if only using RAS in the mix (% by mass of total mix)	3	3	3
Maximum RAP and RAS content if using both RAP and RAS in the mix, subject to the above noted individual maximums (% by mass of total mix)	25	10	20

- Determine asphalt content and gradation of the RAS material for mixture design purposes in accordance with AASHTO T-164, Method A or B and AASHTO T-30. Calculate and ensure the ratio of the virgin binder to total binder is greater than 80% in surface mixtures and 75% in non-surface mixtures. “Surface” mixtures are defined as mixtures that will be final lifts or riding surfaces of a pavement structure. “Non-Surface” mixtures are defined as mixtures that will be intermediate or base layers in a pavement structure.
- RAS shall contain no more that 0.5% by total cumulative weight of extraneous waste materials including but not limited to, metals, glass, paper, rubber, wood nails, plastics, soil, brick tars, and other contaminating substances. This percentage shall be determined on material retained on the 5.000mm sieve
- RAS shall be free from asbestos fibers.
- The Contractor shall, with the mix design, furnish PG test results from the virgin binder, the binder extracted from the individual RAP or RAS materials and PG test results indicating that the binder in the mix resulting from the blending of the RAP, RAS, or RAP and RAS materials meets the grade specified in the contract.

### 6.11.2.3 Asphalt Plant

- In addition to the requirements of Section 6.1 – SGC Hot-Mix Asphalt Concrete, the mixing plant shall be capable of receiving and mixing the proportions of RAP, RAS, virgin aggregate and asphalt cement as designed.
- The mixing plant shall be capable of thorough degradation and heating of RAP and RAS particles and blending with virgin aggregate and asphalt cement to produce a homogeneous mix at the point of discharge.

### 6.11.2.4 Equipment

- **Cold Planer:** to Section 6.6 - Pavement Cold Milling.
- **Haul Vehicle:** capable of receiving milled material directly from the cold planer and hauling directly to a stockpile.
- **Weigh Scale:** shall meet the following requirements:
  - Inspected and certified by Weights and Measures Inspection Services of Canada Consumer and Corporate Affairs as often as directed by the Engineer, with the inspection certificate exhibited as required.
  - Of sufficient size and capacity for weighing any haul vehicle in one operation with all wheels on the platform.
  - Scale house to be provided complete with furnishings, subject to the approval of the Engineer.
- **Mechanical Sweeper:** capable of removing loose material and debris from the milled surface
- **Asphalt Shingle Grinder:** capable of receiving and processing asphalt shingles meeting the end product size requirements listed.

## 6.11.3 Execution

### 6.11.3.1 Reclaiming Asphalt Pavement

- **Cold Milling:** Mill the designated pavement with a cold planer to Section 02961 - Pavement Cold Milling, supplemented as follows:
  - **Sweeping before Milling:** Before milling, sweep the pavement surface with a mechanical sweeper to remove debris and dirt accumulations that may contaminate the millings.
  - Operate the planer in a manner that will minimize tearing and breaking of the underlying and adjacent pavement.

- **Water Use:** Carefully control the amount of water used in milling. Moisture in the RAP is of critical importance during hot-mix production.
  - Load milled material directly from the planer into the haul vehicle.
  - **Sweeping after Milling:** Immediately sweep the milled surface clean with a mechanical sweeper following the planer by not more than 100 m.
  - **Milling Stop Line:** Terminate milling at a uniform line across the roadway at the end of a working day. Provide a transition in the road surface profile at a slope of not more than 25 mm/m.
  - **Rain:** Suspend the milling operation in the event of rain or other inclement weather. Fill the milled area with a paving mix if the potential to pond water exists. Remove the temporary cover before resuming milling operations.
  - **Traffic Hazard:** Promptly repair, to the Engineer's satisfaction, any distress in the newly milled surface which could become a hazard to vehicular traffic.
  - Minimize contamination of the RAP with granular, clay and other deleterious materials at all times.
- **Stockpiling RAP**
    - The RAP becomes the Contractor's property after removal from the jobsite, unless otherwise stated in the Special Provisions of the contract. The Contractor is responsible for stockpiling RAP in accordance with the following guidelines.
    - **Drainage:** Choose a site that has positive surface drainage away from the base of the stockpile.
    - **Stockpile Base:** Must have adequate strength to support the anticipated volume of RAP in the stockpile.
    - **Particle Sizes:** RAP being stockpiled shall meet the following gradation, or must be crushed to obtain the required gradation.

**Table 6.11.2: Stockpiles RAP Gradation**

Sieve Size (mm)	Total % Passing by Mass
125	100
80	99 - 100
40	95 - 100

- Ensure that the RAP is not disturbed after stockpiling. The RAP shall remain loose and un-compacted. No equipment shall be permitted to operate on the stockpile.

### 6.11.3.2 Recycled Asphalt Shingles (RAS)

○ **RAS Production**

Process the RAS by ambient grinding or granulating to meet the requirements in the following table when tested in accordance with AASHTO T27 (prior to extraction process)

**Table 6.11.3: RAS Gradation Requirements**

Sieve Size (µm)	Total % Passing by Mass
10 000	100
5 000	70.0 - 95.0
160	15.0 Max.
80	7.0 Max.

○ **Stockpiling RAS:**

The Contractor is responsible for stockpiling RAS in accordance with the following guidelines.

- **Drainage:** Choose a site that has positive surface drainage away from the base of the stockpile.
  - **Stockpile Base:** Must have adequate strength to support the anticipated volume of RAS in the stockpile
  - Ensure that the RAS is not disturbed after stockpiling. The RAS shall remain loose and un-compacted. No equipment shall be permitted to operate on the stockpile.
    - i. The Contractor may uniformly blend sand or fine aggregate with RAS in stockpiles if needed to keep the processed material workable. The sand or fine aggregate added must be considered in the final gradation of the new HMA.
    - ii. Use RAS that is sufficiently dry to be- free flowing and to prevent foaming when blended with the hot binder.
- If the Contractor elects to use RAS, the following additional conditions shall apply:

The Contractor shall have an approved Quality Control Plan (QCP) that details how the RAS will be processed and controlled. When the Contractor intends to use RAS from a

RAS Supplier, that supplier's QCP shall be submitted by the Contractor. The QCP shall be submitted with the Contractor's HMA mix design and shall address the following:

- **RAS Processing Techniques.** This requires a schematic diagram and narrative that explains the processing (grinding, screening, and rejecting) and stockpile operation for this specific project. Hand sorting of deleterious material prior to grinding is required. In addition, this plan must address the control of agglomeration and moisture.
- **Determination and Control of RAS Asphalt Binder Content (AASHTO T-164, Method A or B):** Frequency: 1/200 tonnes of processed RAS material (minimum five tests).
- **Control of RAS Gradation (CP31 or AASHTO T-30):** Frequency: 1/200 tonnes of processed RAS material (minimum three tests)
- **Asbestos content of RAS:** Frequency: 1/1000 tonnes of processed RAS material (minimum three tests)
- **Moisture content of RAS:** Frequency: 1/day
- **Deleterious Material: Frequency:** 1/1000 tonnes of RAS material (minimum three tests)

#### 6.11.3.3 Production of Recycled Asphalt Mix

Production: Produce recycled asphalt mixture in accordance with the approved mix design and to Section 6.1 – SGC Hot-Mix Asphalt Concrete.

#### 6.11.3.4 Paving

- Paving Operation: to Section 6.3 – SGC Hot-Mix Asphalt Paving.
- Substitute Mix: Provide at least 24 hours' notice to the Engineer if recycled asphalt hot-mix cannot be produced as intended.
- Tolerances: to Section 6.3 – SGC Hot-Mix Asphalt Paving

## 7. CONCRETE

### 7.1 CEMENT CONCRETE

#### 7.1.1 General

##### 7.1.1.1 Content

This section includes the production of Cement Concrete and the requirements for concrete mix design, quality control, quality assurance and placement. The most current editions of industry standards shall be applied except where stated specifically.

##### 7.1.1.2 Related Sections

- Concrete for Roadways Section 7.3
- Concrete Forms and Accessories Section 7.10
- Reinforcing Steel Section 7.12
- Concrete for Water and Drainage Structures Section 03310 – Volume 3: Drainage

##### 7.1.1.3 Submittals

- Submit the cement manufacturer's mill test reports to the Technical Services Section, Transportation Department, monthly or as requested by the City.
- Submit physical fly-ash producer test reports to the Technical Services Section, Integrated Infrastructure Services, monthly or as requested by the City. The test reports shall identify the fly ash source and product stream if available.

##### 7.1.1.4 Quality Assurance

- Provide, without charge, access for the City to inspect equipment, materials and processes used in the production and delivery of concrete and to obtain samples for testing.
- Approval of a mix design, or inspection and testing by the City shall not relieve the Contractor of responsibility for the quality of concrete used in the Work and the provision of a controlled environment for the initial curing of field test specimens (See CSA A23.2-25C).
- The quality assurance laboratory will perform concrete plant checks and quality assurance sampling and testing for slump, air content, air voids system analysis and compressive strength.



- Quality assurance testing shall be performed by a technician certified by **CCIL** or ACI.
- **Slump Tests**
  - **Methods:** to CSA A23.21C and CSA A23.25C.
  - **Test Frequency:** Slump tests will be taken between the 10% and 90% points of discharge of a concrete load with every strength test and as required by the Engineer.
- **Air Content Tests**
  - **Methods:** to CSA A23.21C and CSA A23.24C or CAN CSA A23.26C.
  - **Test Frequency:** Air content tests will be taken between the 10% and 90% points of discharge of a concrete load with every strength test and as required by the Engineer.
- **AirVoid Examination**
  - **Method:** to ASTM C457, modified pointcount traverse method at 100X magnification.
  - **Sample:** a 100 mm diameter core drilled from hardened concrete.
  - **CrossSection Preparation:** The top of the core shall be ground to 2 mm  $\pm$ 0.5 mm below and parallel to the finished concrete surface to produce a surface suitable for microscopic examination.
  - **Maximum Allowable Spacing Factor:** If the spacing factor obtained by a full traverse of the crosssection of the single core is greater than 0.23 mm, the concrete represented by the core shall be removed and replaced.
- **Strength Tests**
  - **Methods:** Compressive strength test specimens shall be cast and cured in accordance with CSA A23.2-3C. Initial curing **period minimum and maximum daily** temperatures must be reported. Test specimens cast from concrete mixes with slump levels equal to or less than 40mm shall be consolidated by **vibration**. The testing agency shall ensure complete densification of the test cylinders and will confirm that corresponding unit weights are characteristic of the mix design unit weights. Test cylinders exhibiting a lack of consolidation will be weighed and the unit weight and accompanying remarks recorded on the concrete test report. Compressive strength determination shall be in accordance with CSA A23.2-9C.

- **Test Frequency:** Standard tests for strength will be conducted at a frequency of not less than one strength test for each 60m<sup>3</sup> of concrete or fraction thereof, for each class of concrete produced in any one day from each individual plant/supplier.
- Definition of a Strength Test: to CSA A23.1.
- For standard strength tests, either 150mm x 300mm cylinders or 125mm x 250mm cylinders may be used. Note: 100mm x 200mm cylinders may be used for summer mixes providing the General Contractor makes provisions on site for a controlled level storage environment free from vibration and that maintains test specimens within a range of 15°C to 25°C for the initial curing period confirmed with field sensor data and with maximum and minimum temperatures for the period of initial curing recorded on the field test report.
- **Required Strength:** The result of each compressive strength test shall equal or exceed the specified minimum compressive strength. In accordance with CSA A23.2.2-25 for a strength determination as a basis for acceptance a minimum of two test cylinders shall be tested.

## 7.1.2 Products

### 7.1.2.1 Concrete Materials

- **Cement:** to CSA A3000 of the following types.
  - Type GU – General use cement, or  
Type GUL - General use cement\*, or  
Type GULb - General use cement\*
  - Type HE - High early-strength cement, or  
HEL - High early-strength cement\*
  - Type HS – High sulphate-resistant cement, or
  - Type HSL - High sulphate resistant cement\*, or
  - Type HSLb - High sulphate-resistant cement\*

\*Portland Limestone Cement meeting the same requirements as the Portland cement equivalent.

Note: Type HSL High Sulphate-resistant Concrete is listed in CSA A3000-18 (2021 Amendment) It is anticipated to be included in the next edition of CSA A23.1 to be published in 2024.

- **Aggregate:** to CSA A23.1/CSA A23.2-30A, testing shall include but not be limited to: unconfined Freeze-thaw in course aggregate,  $MgSO_4$  soundness loss, petrographic examination, alkali-aggregate reactivity, and ironstone content.
- **Water:** to CSA A23.1, clear, free from injurious amounts of oil, acid, alkali, organic matter, sediment, or other substance harmful to the mixing and curing of concrete. For concrete and fillcrete, the City of Edmonton will allow a Maximum of 20% of the mix water can consist of recycled slurry water. If recycled slurry water is utilized in the production of concrete or fillcrete the supplier shall provide quality assurance reports for the slurry water to the Technical Services Section, Transportation Department.
- **Air Entraining Admixture:** to ASTM C260.
- **Chemical Admixtures:** to ASTM C494, including water reducing admixtures, set retarders and accelerators. Chemical admixtures other than Type A, D, F or G water reducing admixtures shall not be used unless permitted in writing by the City or Engineer.
- **Fly Ash:** to CSA A3000 Supplementary Cementitious Material Type F.

#### 7.1.2.2 Forms

To Section 7.10 - Concrete Forms and Accessories.

#### 7.1.2.3 Reinforcement

To Section 7.12 - Reinforcing Steel.

#### 7.1.2.4 Production of Concrete

Produce concrete to clause 5.2, CSA A23.1 and conforming to the approved mix design requirements of Section 7.3 - Concrete for Roadways or Section 03310 - Concrete for Water and Drainage Structures – Volume 3: Drainage.

### 7.1.3 Execution

#### 7.1.3.1 Inspection of Formwork and Reinforcement

- Carefully inspect the installed work of all other trades prior to all of the Work of this section, and verify that all such work is complete to the point where this Work may properly commence.
- Provide 48 hours notice and obtain the City's approval before placing concrete.
- Ensure that reinforcement, formwork, inserts or accessories are securely fastened and will not be disturbed during concrete placement.

- Verify that all items to be embedded in concrete are in place.
- Verify that concrete may be placed to the lines and elevations indicated on the Drawings with all required clearance for reinforcement. In the event of any discrepancy, immediately notify the City. Do not proceed with installation until all such discrepancies have been fully resolved.

### 7.1.3.2 Delivery of Concrete

- Deliver concrete to the job site to CSA A23.1, as supplemented or modified below.
- **Rotating Drum Trucks:** Transport concrete using only equipment with mixing or agitating capability.
- Rotate the drum on the job site at mixing speed for 3 minutes immediately before discharge.
- The minimum load size to be delivered to site is 3 cubic meters.
- **Re-tempering with Water:** Do not add water after the initial introduction of mixing water at the plant except as follows:
  - When the slump at the point of initial discharge is less than specified
  - Introduce additional water into the drum mixer in an amount not exceeding 12 litres/m<sup>3</sup>, to bring the slump to within specified limits. The total amount of water added to the concrete shall not exceed the SSD water content of the approved mix design.
  - Rotate the drum a minimum of 30 revolutions at mixing speed until the required uniformity of concrete is attained.
  - Do not subsequently add any further water to the load.
  - If a load of concrete is re-tempered with water and the resulting slump exceeds the specified maximum slump, that load of concrete will be rejected.
  - If the need for re-tempering with water becomes persistent or continuous, the Engineer or his representative may refuse to accept concrete loads that have been re-tempered with water.
- Slow rotation of the drum for extended periods of time for the purpose of slump reduction in loads of concrete delivered with a slump exceeding the specified maximum slump will only be permitted for concrete placed by extrusion.
- Re-tempering with Air-Entraining Admixtures is only permitted under the following conditions:

- Re-tempering on site with an approved air-entraining admixture shall only be performed by a quality control technician working for the concrete supplier or the Contractor. Dry, powdered, bagged or pre-measured liquid air-entraining admixtures may be added by the concrete truck operator under the direction of the supplier’s quality control technician. For re-tempering purposes the concrete supplier shall use an air-entraining admixture compatible with what was originally approved for use in the mix design. Rotate the drum for 3 to 5 minutes at mixing speed or until the mix is uniform, after the addition of the air entraining admixture.
- The quality assurance technician shall perform an air content test on each load of concrete re-tempered with air-entraining admixtures and shall immediately provide the test results to the Engineer.
- Guidelines for re-tempering with air-entraining admixtures

**Table 7.1.1: Re-Tempering Guidelines with Air-Entraining Admixtures**

Measured Air Content (%)	Action
5.0 – 5.4	Addition of water or air-entraining admixtures as deemed necessary by the supplier to meet specifications
4.0 – 4.9	Air-entraining admixtures or air-entraining admixtures and water must be added as deemed necessary by the supplier to meet specifications
< 3.9	No re-tempering with air-entraining admixtures or water is permitted; load will be rejected

- When re-tempering with air-entraining admixtures, the supplier will be given one opportunity to meet the specified air content provided that the maximum allowable discharge time will not be exceeded.
- When initial load requires re-tempering, the quality assurance technician shall perform an air content test to verify air content on subsequent loads until such time air content is acceptable.
- If the need for re-tempering with air-entraining admixtures becomes persistent or continuous, the Engineer or his representative may refuse to accept concrete loads that have been re-tempered with air-entraining admixtures.
- The use of de-airentraining admixtures is not permitted.
- A load of concrete will be rejected if it is re-tempered with air-entraining admixtures and fails to meet specified air content.
- A load of concrete that is rejected at the jobsite may not be re-tempered at the concrete plant with cement, aggregate, sand or admixtures and subsequently returned to any City jobsite.

- On site mix adjustments with cementitious materials, sand aggregate or any chemical admixtures other than air-entraining admixtures and superplasticizers will not be permitted.
- When the ambient air temperature in the shade is 23° C or higher, concrete at time of placement shall not have a temperature exceeding 30° C.
- When the ambient air temperature is lower than 5° C, the concrete delivered to the site shall have a temperature between 15° C and 30° C.
- **Discharge Time:** Complete the discharge of concrete within 90 minutes of the initial introduction of mixing water to the cement and aggregate at the plant. The discharge time may be extended to 120 minutes by incorporating hydration control admixtures. The supplier must submit mix designs for approval and provide evidence that the plastic concrete properties (slump, air content and temperature) can be maintained through the extended discharge time period.
- **Delivery Record:** Provide the Engineer, contractor or owner with a delivery ticket either in paper or electronic format showing the batch plant location, the supplier's name, ticket and truck numbers, mechanically punched/batch system electronically logged date and time of initial plant mixing, class and mix design designation, cement type and aggregate sizes, type and amount of admixtures or water added at site, volume of concrete, site arrival time, start and end of discharge time and other information requested by the Engineer, contractor or owner.

### 7.1.3.3 Placing Concrete

- Handle, deposit and consolidate fresh concrete to CSA A23.1 and as supplemented below.
- Moisten the surface of the subgrade or subbase before placing concrete to minimize absorption of water from the deposited concrete. Do not create mud, nor let water pond.
- Ensure that reinforcement and formwork are thoroughly cleaned and that form release agent is applied only to the form face and not intentionally to any of the reinforcement before placing concrete.
- Do not place concrete during rain or when there is imminent danger of rain or if the weather, in the opinion of the Engineer, is not suitable.
- Place hot and cold weather concrete to CSA A23.1. Ensure that the procedures used are approved by the Engineer.
- Pour concrete continuously and as rapidly as possible between predetermined construction joints to the approval of the Engineer.

- Locate construction joints to Section 7.10- Concrete Forms and Accessories.
- Consolidate concrete in accordance with CSA A23.1.
- Concrete cover over reinforcing steel shall be to CSA A23.1.

#### **7.1.3.4 Finishing**

- Perform the initial and final finishing of the plastic concrete surfaces to CSA A23.1 and as supplemented below.
- Do not apply water to the concrete surface to facilitate finishing under any circumstances. To retain surface moisture and facilitate concrete finishing, the contractor may apply an evaporation retarder to the surface during the pause interval between floating and finishing operations.
- Protect the Work from rain to avoid excessive moisture on the unfinished surface and to prevent pitting to the finished surface if still plastic.
- Concrete finishing shall be performed by or under the direct site supervision of a certified Journeyman concrete finisher.

#### **Curing**

Cure exposed concrete surfaces using a specified curing compound applied with a pressurized spray nozzle per the manufacturer's recommendations. Curing compound shall be applied within 5 to 15 minutes after completion of the finishing process and cover the entire exposed surface with an unbroken and uniform film.

## 7.2 CONCRETE SIDEWALK, CURB AND GUTTER, AND SLABS

### 7.2.1 General

#### 7.2.1.1 Content

This section includes the construction of Cement concrete curb, curb and gutter, gutter, walk, monolithic curb, gutter and walk, median or island slabs, curb ramp and crossings.

#### 7.2.1.2 Related Sections

- Aggregate Section 2.1
- Cement Concrete Section 7.1
- Concrete for Roadways Section 7.3
- Concrete Forms and Accessories Section 7.10
- Reinforcing Steel Section 7.12
- Subgrade Preparation Section 4.1

#### 7.2.1.3 Quality Assurance

Slump, Air Content, Nuclear Density Tests, AirVoid Examination, Strength Tests and Acceptance Criteria to Section 7.1 - Cement Concrete.

### 7.2.2 Products

#### 7.2.2.1 Materials

- Concrete: Class A or Class C, to Section 7.1 - Cement Concrete and Section 7.3 - Concrete for Roadways.
- Joint Sealant, Preformed Joint Filler, Curing Compound and Probe Hole Grout To Section 7.3 - Concrete for Roadways.
- Reinforcement Bars, Tie Bars, Dowels, Welded Steel Wire Fabric To Section 7.12 - Reinforcing Steel

### 7.2.3 Execution

#### 7.2.3.1 Types of Construction

The Contractor has the option of constructing the following types of work by hand forming or by slipforming methods, or by a combination of both. Construct as detailed on plans and drawings, or in the contract Special Provisions, or as directed by the Engineer.



- **Curb, Curb and Gutter, Gutter**

Construct curb, curb and gutter and gutter on prepared subgrade, cement stabilized subgrade, granular base course, soil cement, or asphalt concrete, as indicated on the drawings.

- **Walk**

Construct walk on a granular base course.

- **Monolithic Walk Curb and Gutter**

Construct the walk portion of monolithic walk, curb and gutter on a granular base course. If the walk portion is wider than 2 m, place longitudinal and transverse crack control joints at the proper spacing.

- **Curb Ramps**

Curb ramps are an incline built monolithically into curb cut and walk. Construct curb ramps on a granular base course.

- **Alley Crossings**

The Engineer will set stakes for alley crossings. Construct alley crossings on a granular base course and monolithically with the drop curb and gutter. All alley crossings are to be Class A concrete.

- **Commercial and Private Crossings**

Commercial and private crossings will be staked by the property owner who has obtained the required permit. Do not construct the crossing beyond the extension of the property line across the walk or boulevard. Construct commercial or private crossings on a granular base course and monolithically with the drop curb and gutter. Commercial crossings are to be Class A concrete.

- **Median or Island Strip**

Construct median or island strips on a granular base course between curbs in the median or island.

- **Slabon Median or Island**

Construct slab-on medians or islands on the existing pavement surface.

### 7.2.3.2 Preparation

Verify that the prepared subgrade or base is ready for concrete placement and repair any deterioration or damage.

- **Cut behind Curb**

Compact soil to Section 4.1 - Subgrade Preparation and trim to within 25 mm of the back of curb.

- **Granular Base Course**

The granular base course under concrete walk, curb ramps, lane crossings, commercial and private crossings, median or island strips and the walk portion of monolithic walk, curb and gutter shall consist of 150 mm compacted thickness of Designation 3 Class 20A aggregate. Compaction and tolerance testing shall be to Section 5.1 – Granular Base Courses.

### 7.2.3.3 Hand Forming

- Place forms to Section 7.10 - Concrete Forms and Accessories and as supplemented below.
- Use flexible forms to construct curves of less than 40 m radius.
- Place a minimum 50 m of forms before a concrete pour to allow checking for true line and grade.
- The Engineer will not allow the use of forms that are out of shape, dented, rough, or otherwise unsuitable.

### 7.2.3.4 Placing Reinforcement

Place reinforcement of the type, size and spacing as detailed on drawings or as required by Engineer, to Section 7.12 - Reinforcing Steel.

### 7.2.3.5 Placing Concrete

- Place concrete to Section 7.1 - Cement Concrete and Section 7.3 - Concrete for Roadways and as supplemented below.
- Use 50 mm pencil vibrators for curb and gutter and approved vibrating screeds for walk and slabs.
- Place concrete continuously until the scheduled pour is complete. Arrange the rate of concrete delivery to ensure that the discharge interval between successive loads does not exceed 30 minutes. If the discharge interval is greater than 30 minutes, place a construction joint.

- Where possible curblines, curbs, ramps and curbside crossings shall be poured monolithically. Where it is possible to pour the curblines, curbs, ramps and curbside crossings monolithically the use of dowels and joint sealant at the back of the curb is not permitted.

#### **7.2.3.6 Slipforming**

- Slipform concrete to Section 7.10 - Concrete Forms and Accessories and as supplemented below.
- Hand form and place concrete at corners, driveways and catch basins concurrent with the slipforming operation. Where concurrent work is not practical, complete this work within 7 days of the slipforming of adjacent work.

#### **7.2.3.7 Finishing**

- Finish concrete to Section 7.1 - Cement Concrete and Section 7.3 - Concrete for Roadways and as supplemented below.
- Tool all edges and joints to a width of 50 mm and round edges to a 6 mm radius unless indicated otherwise.
- Apply a brush final finish longitudinally along curb and gutter and transversely on walk and slabs.
- Name Plate
  - Stamp the Contractor's name and year of construction in the plastic concrete on:
  - The top of the curb in each block or at 200 m intervals, whichever is less and
  - The walk at the end of each block on an extension of a property line.

#### **7.2.3.8 Crack-Control Joints**

- Formed or tooled to Section 7.3 - Concrete for Roadways and as supplemented below.
- **Contraction Joint Size**
  - 3 mm to 5 mm wide at the following depths:
    - **For curb and gutter:** 50 mm minimum to a maximum of 25% of the gutter depth.
    - **For walk and slabs:** 25 mm minimum to a maximum of 25% of the walk or slab thickness.
    - **Contraction Joint Spacing:** 3 m maximum.

- **Surface Dummy Joints:** tooled 5 mm wide by 10 mm deep, centred between contraction joints across walk and slabs. In monolithic construction, place surface joints across the walk portion and contraction joints on the curb and gutter, both joints being on same line. Where required, place a longitudinal surface joint on walk and slabs continuing on through alley crossings and driveways.

#### **7.2.3.9 Transverse Construction Joints**

- Place to Section 7.3 - Concrete for Roadways and as supplemented below.
- Use 10M deformed tie bars at 300 mm spacing and extending 300 mm minimum into both sides of the joint.
- Vary joint spacing near the end of a concrete pour as follows:
- If a concrete pour ends within 300 mm of a required joint location, average the spacing of last two joints.
- If a concrete pour ends within 800 mm of a required joint location, average the spacing of last 3 joints.

#### **7.2.3.10 Longitudinal Construction Joints**

- Place according to Section 7.3 - Concrete for Roadways and as supplemented below.
- Use 10M deformed tie-bars at 1 m spacing and extending 300 mm minimum into both sides of the joint.

#### **7.2.3.11 Joints Abutting Existing Curb**

- Form a 10 mm wide by 30 mm deep slot between the back of curb and the walk or slab.
- Fill the slot with a specified joint sealant.

#### **7.2.3.12 Isolation Joints**

Construct to Section 7.3 - Concrete for Roadways.

#### **7.2.3.13 Protection and Curing**

Protect and cure concrete to Section 7.3 - Concrete for Roadways.

#### **7.2.3.14 Backfilling**

- **Backfill Material**

If excavation is part of the work, use approved material from site excavation. If excavation is not part of the work, supply fill material approved by the Engineer.

- **Behind Curb**

Backfill with suitable clay within 7 days of concrete placement and before placing the initial paving course against the curb and gutter, a minimum of 300 mm width behind the curb in two 150 mm lifts. Tamp each lift with mechanical tampers to a minimum 95% of maximum density. Backfill to the top of curb elevation, unless topsoil placement or walk/slab construction immediately follows, in which case leave backfill low to accommodate subsequent work.

Please note the requirements of Section 7.2.3.14 of Volume 2 in this regard with respect to backfill behind curb and gutter. Any requirement for 300 mm of topsoil is overridden by the requirement to brace curb and gutter against rotation due to paving or soil pressure over time.

- **Along Slab Edges**

Backfill along the edge of the walk or slab as soon as practical after the removal of concrete forms, allowing for topsoil depth, unless otherwise directed by the Engineer. Tamp with mechanical tampers a minimum 300 mm width along the slab edge to a minimum 92% of maximum density.

- **Maximum Density**

As used in this Section, is the dry unit mass of sample at optimum moisture content as determined in the laboratory according to ASTM D698 Method A.

### **7.2.3.15 Field Quality Control**

- **Walk or Slab Surface Tolerances**

Maximum variation under a 3 m straightedge: 6 mm.

Maximum variation from walk crossfall:  $\pm 1\%$  provided the finished crossfall is not less than 1% nor more than 4%.

- **Gutter Surface and Curb Top Tolerances**

Maximum variation under a 3 m straightedge: 6 mm.

- **Grade of Gutter Lip and Walk/Slab Tolerances**

- Maximum variation from designated elevation at any station as established from the survey stake:  $\pm 6$  mm.
- Maximum variation from the difference in designated elevations between 2 consecutive stations as established from survey stakes, provided there is positive drainage in the designated direction:  $\pm 12$  mm.

- Lip of Gutter Alignment Tolerances

Maximum deviation: ±12 mm in 30 m.

- When Tolerances Exceeded: If any of the tolerances above are exceeded, remove or correct the concrete work in question as directed by the Engineer.
- Walk, Median Strip, Slab-on, Ramps or Crossing Thickness:

At the City's request, the quality assurance laboratory will take one or more sets of cores from suspect concrete walk or crossing, each set comprising 3 cores whose average thickness represents not more than 500 m<sup>2</sup> of concrete walk or crossing. If the average core thickness is deficient that area will be assessed a pay factor according to Table 7.2.1

**Table 7.2.1: Concrete Walk/Crossing Thickness Pay Factors**

THICKNESS DEFICIENCY (mm)	PAY FACTOR (% of Contract Price)
6	100.0
7	97.0
8	93.7
9	90.0
10	85.5
11	80.5
12	75.0
13	68.0
14	60.0
15	50.0
Over 15	Remove and replace

Concrete walk or crossing with excess thickness may be accepted if surface and grade tolerances are met, but no claim for additional payment will be accepted.

**7.2.3.16 Rejected Concrete Work**

Remove and replace rejected concrete work by full segments or slabs between crack control or construction joints.

**7.2.3.17 Protection of Finished Work**

- Protect finished work from damage. Repair if damaged.
- Do not open walk or crossings to traffic until permitted by the City. When opening to traffic, leave walk or crossings clean and free of debris and remove signs and barricades no longer needed.

## 7.3 CONCRETE FOR ROADWAYS

### 7.3.1 General

#### 7.3.1.1 Content

This section includes the production of Cement concrete for pavement and associated structures, and additional requirements for concrete mix design, quality control, quality assurance, and placement for pavement and associated structures.

#### 7.3.1.2 Related Sections

- Trench and Backfill Section 3.1
- Cement Concrete Section 7.1
- Concrete Forms and Accessories Section 7.10
- Reinforcing Steel Section 7.12

#### 7.3.1.3 Submittals

- Submit a mix design for each designated class of concrete to the Technical Services Section, Transportation Department, at least 14 days prior to initial concrete work and when there is a change in materials, sources or proportions. Submit separate mix designs specifically designed for particular placement applications (i.e. pumping, hand placement, slip form placement, etc.)
- Submit a complete petrographic analysis of the fine and coarse aggregate proposed for use with the concrete mix design. The petrographic analysis shall include the results of unconfined Freeze-thaw in course aggregate,  $MgSO_4$  soundness loss and alkali-aggregate reactivity evaluation.
- Submit the results of ironstone determination to the Technical Services Section, Transportation Department, at least once per week.
- Submit the results of acceptance testing for compliance with the “Limits for deleterious substances and physical properties of aggregates” provided in CSA A23.1 Table 12.
- Submit the results of and the evaluation of alkali-aggregate reactivity.

#### 7.3.1.4 Quality Assurance

To Section 7.1 Cement Concrete

### 7.3.1.5 Quality Control

- The supplier shall conduct a quality control program that will ensure their concrete product meets the specifications. The supplier shall provide test results, if requested by the Engineer. The quality control program should be conducted at the plant with corresponding spot checks at the jobsite. Construction sites are not to be used as reactionary quality control points by the supplier to deficiencies in the supplied product through excessive or continuous re-tempering of the mix.
- Quality control testing initiated by the supplier shall be performed by a CSA or ACI certified technician.

## 7.3.2 Products

### 7.3.2.1 Materials

- **Cement:** To Section 7.1 Section 3.1
- Cement Concrete
- **Aggregate:** To Section 7.1 Cement Concrete, and as supplemented below:
  - **Petrographic Analysis:** To be performed by a qualified laboratory to CSA-A23.2-15A.
  - **Ironstone Content:** To be performed by an approved facility to the Method for Ironstone Content Determination in Fine and Coarse Concrete Aggregates, which is available from the Technical Services Section, Integrated Infrastructure Services. Do not use aggregate until the corresponding results have been reviewed by the Engineer. Ironstone content in coarse aggregate shall not exceed 1.0% by mass of the total coarse sample (retained on the 5 mm sieve and larger), and in fine aggregate shall not exceed 1.5% by mass of the total dry, unwashed fine aggregate sample (passing the 5 mm sieve to that retained on the 2.5 mm sieve). Any concrete supplied with aggregate exceeding the specified ironstone content will be rejected, and shall be removed by the Contractor as directed by the Engineer.
- **Water:** To Section 7.1 Section 3.1
- Cement Concrete
- **Fly Ash:** For Class A, B, and C concrete no replacement of the specified minimum cement content with fly ash from the commencement of the construction season to May 15 and after September 30 unless permitted by the City Engineer.



- **Sulfate Resistant Concrete:** Sulphate resistant concrete made with Portland or Portland Limestone Cements with less than 4.0% C<sub>3</sub>A shall not be placed after September 30, for Class A, B, and C concrete.
- **Curing compound:** to ASTM C309, Type 2, class B, white pigmented, resin based, liquid membrane-forming compound.
- **Evaporation Retarder:** The concrete evaporation retardant must be a commercially available monomolecular film compound. Currently there is no ASTM designation for this product, however the manufacturer must certify the evaporation retardant has no adverse effect on the cement hydration process or the concrete and that it reduces surface moisture evaporation from the concrete when performing concrete operations in direct sun, wind, high temperatures, or low relative humidity.
- **Preformed Joint Filler:** to ASTM D1751.
- **Joint Sealant:** to AASHTO M324 or ASTM D6690 and D5078, Sika 2c or approved equivalent.
- **Forms:** To Concrete Forms and Accessories.
- **Reinforcement:** To Section 7.12 Reinforcing Steel.

### 7.3.2.2 Mix Design

- Application of concrete classes:
  - Class A: One course exposed pavements, commercial and residential alley crossings.
  - Class B: Unexposed pavement base.
  - Class C: All exposed road associated works including curb and gutter, sidewalks, walkways, private crossings, swales, medians, New Jersey barriers and parapet walls.
  - Class D: Structural pile foundations, sign and street light bases.
  - Class E: Exposed retaining walls.
- Mix design criteria for each class of concrete:

**Table 7.3.1: Spring and Fall Mixes**

Class	Minimum 28 Day Compressive Strength (MPa)	Slump (mm)	Entrained Air Limits (% by volume)	Maximum Aggregate Size (mm)	Maximum Water to Cementing Materials Ratio (by mass)	Minimum Portland Cement/ Portland Limestone Cement Content (kg/m <sup>3</sup> )	Cement Type
A	30	80 ± 20	5.5 - 8.0	20	0.45	335	GU/GUL GUb/GULb
B	30	80 ± 20	5.5 - 8.0	20	0.45	335	GU/GUL GUb/GULb*
C	30	80 ± 20	> 5.5	20	0.45	335	GU/GUL GUb/GULb*
D	30	80 ± 20	5.5 - 8.0	20	0.45	335	HS/HSL** HSb/HSLb*
E	30	80 ± 20	5.5 - 8.0	20	0.45	300	HS/HSL** HSb/HSLb*

\* Note: GUb/GULb and HSb/HSLb cements can be used only upon approval of the Engineer and must meet the minimums stipulated in Table 7.3.1.

\*\*Type HSL High sulphate-resistant cement is listed in CSA A3000-18 (2021 Amendment) It is anticipated to be included in the next edition of CSA A23.1 to be published in 2024.

**Table 7.3.2: Summer Mixes**

Class	Minimum 28 Day Compressive Strength (MPa)	Slump (mm)	Entrained Air Limits (% by volume)	Maximum Aggregate Size (mm)	Maximum Water to Cementing Materials Ratio (by mass)	Minimum Portland Cement/ Portland Limestone Cement Content (kg/m <sup>3</sup> )***	Cement Type
A	30	80 ± 20	5.5 - 8.0	20	0.45	302	GU/GUL GUb/GULb
B	30	80 ± 20	5.5 - 8.0	20	0.45	302	GU/GUL GUb/GULb*
C	30	80 ± 20	> 5.5	20	0.45	302	GU/GUL GUb/GULb*
D	30	80 ± 20	5.5 - 8.0	20	0.45	335	HS/HSL** HSb/HSLb*
E	30	80 ± 20	5.5 - 8.0	20	0.45	300	HS/HSL** HSb/HSLb*

\* Note: GUb/GULb and HSb cements must meet the minimums stipulated in Table 7.3.2.

\*\*Type HSL High sulphate-resistant cement is listed in CSA A3000-18 (2021 Amendment) It is anticipated to be included in the next edition of CSA A23.1 to be published in 2024.

\*\*\*Values shown are minimum cement content only (not cement + fly ash). Total values for cement content + fly ash content are as shown in Table 7.3.1

- **Class C concrete:** shall attain the minimum compressive strength corresponding to the percentage of entrained air in the plastic concrete as follows.

**Table 7.3.3: Class C Concrete Compressive Strength Requirement**

Air Content (%)	Minimum 28 Day Compressive Strength (MPa)
5.5 to 5.9	30.0
6.0 to 8.0	42 - (2 * Air Content)
greater than 8.0	26.0

- **High Early Strength Concrete:** For special situations or conditions the Engineer may require that the specified 28 day compressive strength be met in 7 days.
- If any class of concrete is to be placed by pumping, the specified slump and air content shall be met at the point of pump discharge. Samples for testing will be obtained at the point of pump discharge.

NOTE: Pump boom configuration, line size, distance, pump rate, and ambient conditions may influence plastic air results observed at the point of discharge when pumping (air content may increase or decrease). Contractors are permitted to work with the concrete supplier to achieve the specified air entrainment and slump at the point of placement provided that affected concrete is discharged into the element within the specified time limit. While it should be the goal of both parties to minimize the need for onsite adjustments, it is recognized that multiple adjustments may on occasion be required when conditions change.

- For Class C extruded parapet retaining walls and New Jersey Barriers the mix shall contain 0.6kg of synthetic micro fibres or approved equivalent per m<sup>3</sup> of concrete.
- For Class E concrete the following mix conditions shall apply:
  - A minimum ratio of supplementary cementitious materials to total mass of cementitious materials of 0.15, and
  - A minimum sand content of 45% by total weight of aggregate.
  - Slump may be increased using an approved superplasticizer to 120 mm for a mix with GU/GUL/GULb/HS/HSL/HSLb cement and 90 ± 30 mm for mixes where high early strength is a requirement.
- **Application of concrete classes:**
  - Class A: One course exposed pavements, commercial and residential alley crossings.
  - Class B: Unexposed pavement base.

- Class C: All exposed road associated works including curb and gutter, sidewalks, walkways, private crossings, swales, medians, New Jersey barriers and parapet walls.
- Class D: Structural pile foundations, sign and street light bases
- Class E: Exposed retaining walls.

○ **Seasonal concrete mix requirements:**

● **Spring Mixes**

From the commencement of the construction season to May 15, or as directed by the City: no replacement of the minimum cement content with fly ash (Clause 7.3.2.1 – Fly Ash) is permitted.

● **Summer Mixes**

From May 16 to September 30: no more than 10% of the specified minimum cement content may be replaced with fly ash. Minimum cement content values shown in Table 7.3.2 already account for the maximum fly ash replacement. Total values for cement content + fly ash content are as shown in table 7.3.1. For example, for summer mixes Type A, B and C the minimum total cement content + fly ash content is 335 kg/m<sup>3</sup>, with a minimum of 302 kg/m<sup>3</sup> cement content.

● **Fall Mixes**

From October 1 to October 15: no replacement of the minimum cement content with fly ash is permitted (Clause 7.3.2.1-Fly Ash) and cements with less than 4.0% C<sub>3</sub>A may not be used (Clause 7.3.2.1 - Sulfate Resistant Concrete ).

● **Cold Weather Mixes**

From October 16 to the end of the construction season, or as defined by the Engineer: meet the requirements for cold weather concrete below.

- **Cold weather concrete:** All classes of concrete placed after October 15 shall attain a minimum compressive strength of 27.0 MPa in 7 days and shall be provided with cold-weather protection to CSA A23.1. High early strength concrete (as defined in CSA A23.1 shall attain a minimum compressive strength of 30.0 MPa in 7 days and shall be provided with cold weather protection to CSA A23.1 (type 2 curing). This cold weather protection must be adequate to maintain concrete surface temperatures at a minimum of 10° C for a period of 7 days following placement.
- For slipformed (machine placed) concrete, limit slump as follows:
- 20 ± 10 mm for curb, curb and gutter and New Jersey barrier, and

- 30 ± 10 mm for walk, monolithic walk and pavement.
- Type HE/HEL or Type HS/HSL\*\*/HSLb cement may be substituted for Type GU cement, except as limited in Clause 7.3.2.2 –Class E Concrete.
- Class A, C and E concrete may be subjected to air-void system examination.
- Concrete mix designs shall be prepared by a CSA approved laboratory, or by a concrete supplier with the capability and a facility approved by the City.
- If requested, the supplier shall provide evidence that proportions in the mix design will produce concrete of the quality specified. Include strength tests on trial mixes made under plant conditions.
- Concrete production may not proceed until the City has approved the applicable mix design.

### 7.3.3 Execution

#### 7.3.3.1 Placing

- Place concrete to Section 7.1 Section 3.1
- Cement Concrete.

#### 7.3.3.2 Finishing

- Finish concrete to Section 7.1 Cement Concrete, and as supplemented below:
- **Brush or Broom Finish:** Use a brush or a broom with nylon bristles that can form surface grooves no deeper than 3 mm. Remove excess water from the bristles before brushing. Brush in the designated direction.

#### 7.3.3.3 Joints

Construct joints as required in each type of construction to the following standards as applicable.

- **CrackControl Joints:** intended to control the location of shrinkage cracks in hardening concrete. Construct joints to the indicated dimensions, spacing, and pattern by any of the following methods:
- **Formed Joint:** Form the groove by inserting a metal or fibre strip, or polyethylene film into the plastic concrete. Finish the edges to a 6 mm radius. Remove the insert immediately after the initial set of the concrete. Seal the joint with a specified sealant.

- **Tooled Joint:** Hand form the groove using a jointing tool with a thin metal blade to impress a plane of weakness into the plastic concrete. Finish the edges to a 6 mm radius. Seal the joint with a specified sealant.
- **Sawed Joint:** Cut the groove with a concrete saw as soon as the concrete surface has hardened sufficiently to resist raveling as the cut is made, but before shrinkage cracks form in the concrete. The Contractor is responsible for the proper timing of the saw cut. Immediately flush the saw cut clean with water. Once the joint surfaces are dry, seal the joint with a specified sealant.
- **Isolation Joint:** required where concrete is placed adjacent to an immovable structure or where indicated on the Drawings. Construct the joint by sawing or forming to create a clean break through the full cross section of the concrete member. Make the joint wide enough to permit a snug fit for the pre-formed joint filler. Alternatively, place the pre-formed joint filler against the structure and pour the concrete against the pre-formed joint filler.
- **Construction Joint:** required between concrete pours or for joining new concrete to existing work. Construct the joint with a keyway, dowels or tie bars as detailed on the drawings or as directed by the Engineer. Finish edges to a 6 mm radius. Vertically trim the existing concrete by sawing at least 50 mm deep and breaking. Leave the joint form in place until the concrete has set, then remove the joint form without damaging the concrete.

#### 7.3.3.4 Protection and Curing

- Protect freshly placed concrete from freezing, premature drying, temperature extremes, adverse weather conditions, and physical disturbance to clause 7.4, CSA A23.1, and as supplemented below.
- **Cold Weather Protection:** Concrete shall be protected from freezing for a minimum of 7 days after placement or for the time necessary to achieve 75% of the specified 28-day compressive strength.
- **Membrane Curing:** Cure exposed concrete surfaces using a specified curing compound applied with a pressurized spray nozzle. Curing compound shall be applied within 5-15 minutes after final finishing and cover the entire exposed surface with an unbroken and uniform film at a rate depending on surface roughness but not less than 1 litre per 4 m<sup>2</sup> of surface. Membrane curing will not be required when the maximum daily air temperature for the 72 hours following placement of the concrete is not expected to be greater than 5° C.
- **Moist Curing:** Use where specified or directed by the Engineer. After the concrete has set, maintain exposed surfaces continuously moist using wet burlap or polyethylene film in contact with the concrete for a minimum of 7 consecutive days after placement when

Type GU/GUL/GULb or Type HS/HSL\*\*/HSLb cement is used, or a minimum of 3 consecutive days when Type HE/HEL cement is used.

- **Surface Sealant:** An approved sealing solution shall be sprayed on all exposed concrete surfaces in accordance with the manufacturers recommendations. The concrete shall be dry and swept clean prior to the application of the sealant.

**7.3.3.5 Field Quality Assurance**

- The contractor and the concrete supplier shall assist the field technician in obtaining samples for quality assurance testing.

The contractor shall suspend pouring operations after sampling until the results of the field quality tests are known.

- **Inadequate Protection and Curing**

For concrete where the surface temperature is measured to be below 0°C the concrete may be accepted subject to a pay factor according to Table 7.3.4.

**Table 7.3.4: Cold Weather Protection Pay Factors**

TIME AFTER PLACEMENT THAT CONCRETE TEMPERATURE DROPS BELOW 0° C	PAY FACTOR (% of Contract Price)
> 96 hours	100.0
72 to 96 hours	80.0
48 to 72 hours	70.0
< 48 hours	Remove and Replace

- **Deficient Slump**

For any load of concrete, if the measured slump is outside the specified limits, a check test is taken on another portion of the load, or a retest is done if re-tempering with water is permitted by the Engineer. If the second test fails, the Engineer may reject that load of concrete including removal of the portion already poured. When the slump exceeds the maximum allowable, no retesting of the concrete will be allowed

- **Deficient Air Content**

- For any load of concrete, if the tested air content is outside the specified limits, the Engineer will require one of the following:
  - **Air content between 5.0% and 5.5%:** Concrete poured from the load shall be removed and the rest of the load shall be discarded. However, the Contractor may elect at the Contractor’s risk to pour the rest of the load provided that within 40 days of placement, the Contractor submits to the Engineer proof that the load of concrete meets the required spacing factor as determined from air void examination

performed by a qualified laboratory to CSA A23.2, failing which the Contractor shall remove and replace all concrete represented by the failed test.

- **Air content below 5.0%:** Concrete poured from the load shall be removed and the rest of the load shall be discarded.
- **Air content above 8.0%:** Except for class C concrete, concrete poured from the load shall be removed and the rest of the load discarded. For class C concrete where high early strength is not specified, the concrete will be accepted if the specified 28 day strength is met.
- If the measured air content is below the specified minimum air content, then the contractor may elect to re-temper with air entraining admixtures to Section 7.1 - Cement Concrete, clause 3.2.6.

- **When Air Void Examination Is Required:**

The quality assurance laboratory will drill cores from the hardened concrete for air void examination to Section 7.1Section 3.1

Cement Concrete, Clause 7.1.1.4 Quality Assurance – Air-Void Examination, at a frequency of at least one core for each 2,000 m of local and collector sidewalk, curb and gutter or monolithic walk, curb and gutter, or as requested by the City for arterial, industrial or commercial roadways or small residential subdivisions.

- Where concrete has been rejected and is to be removed for not meeting the spacing factor requirement in Section 7.1 Cement Concrete Clause 7.1.1.4 Quality Assurance – Air Void Examination, the Contractor at the Contractor’s expense shall prove that the concrete left in place at both ends of the removal meets the specified spacing factor by air void examination to be performed by a qualified laboratory to Section 7.1 Cement Concrete. The test results shall be submitted to the Engineer.
- **Deficient Strength:**
    - Concrete work for roadways represented by a strength test result which is less than specified may be accepted subject to a pay factor according to Table 7.3.5. If strength deficiencies persist, the Engineer will require changes in the concrete mix design for the remainder of the work.



**Table 7.3.5: Concrete Strength Pay Factors**

CYLINDER STRENGTH (% of Specified Strength)	PAY FACTOR* (% of Contract Price)
97.0	100.0
96.0	99.2
95.0	98.2
94.0	96.9
93.0	95.4
92.0	93.6
91.0	91.7
90.0	89.4
89.0	86.7
88.0	83.5
87.0	79.7
86.0	75.5
85.0	70.0
Under 85.0	No Payment**

\*Pay factors do not apply to lighting bases or structural piles

\*\*The City may require removal and replacement of concrete below 85% of specified strength

- **Optional core strength test:**

The Contractor has the option at the Contractor’s expense of providing evidence of strength by coring and testing to CSA A23.214C moisture conditioned, by a qualified laboratory within 7 days of a failed 28-day cylinder test or within 3 days of a failed 7-day cylinder test. Three cores shall be drilled from the hardened concrete represented by the failed cylinder strength tests at locations approved by the Engineer.

The average strength of the 3 cores shall equal 100% of the specified cylinder strength; if the concrete fails to meet 100% of the specified cylinder strength then the concrete represented by the testing will be subject to the pay factors of Table 7.3.5 on the basis of the cylinder strength tests.

- Optional core strength test results shall be submitted to the Engineer with a copy to the Technical Services Section, Integrated Infrastructure Services.

## 7.4 CONCRETE BASE

### 7.4.1 General

#### 7.4.1.1 Content

This section includes the construction of non-reinforced Cement concrete base for streets and alleys intended for asphalt surfacing.

#### 7.4.1.2 Related Sections

- Aggregate Section 2.1
- Cement Concrete Section 7.1
- Concrete for Roadways Section 7.3
- Concrete Forms and Accessories Section 7.10
- Reinforcing Steel Section 7.12
- SGC Hot-Mix Asphalt Concrete Section 6.1
- SCG HotMix Asphalt Paving Section 6.3

#### 7.4.1.3 Quality Assurance

- Slump, air content and strength tests and acceptance criteria: to Section 7.3 - Concrete for Roadways.

### 7.4.2 Products

#### 7.4.2.1 Materials

- Concrete: class B, to Section 7.3 - Concrete for Roadways.
- Tie bars, reinforcement if required, preformed joint filler and curing compound: to Section 7.1 - Cement Concrete, Section 7.3 - Concrete for Roadways and Section 7.12 - Reinforcing Steel.
- Granular Backfill: to Section 2.1 - Aggregate, Designation 3 Class 20A.

#### 7.4.2.2 Equipment

Slipform Paver: to Section 7.10 - Concrete Forms and Accessories, equipped with adequate internal vibrators to consolidate concrete to the full depth and width of the slab; adjustable to crown and crossfall; subject to approval by the City.

### 7.4.3 Execution

#### **7.4.3.1 Preparation**

- Have prepared subgrade or sub-base inspected by the City prior to placing concrete.
- Repair and retest disturbed subgrade or sub-base and remove debris and loose material from the surface.

#### **7.4.3.2 Hand Forming and Placing Concrete**

- Place forms, reinforcement if required and concrete to Section 7.1 - Cement Concrete, Section 7.3 - Concrete for Roadways, Section 7.10 - Concrete Forms and Accessories and Section 7.12 - Reinforcing Steel and as supplemented in this section.
- Place concrete continuously until scheduled pour is complete. Arrange the rate of concrete delivery to ensure that the discharge interval between successive loads does not exceed 30 minutes. If this discharge interval is exceeded, place a construction joint.

#### **7.4.3.3 Slipforming**

- Place concrete by slipform paver to Section 7.10 - Concrete Forms and Accessories, and as supplemented below.
- Remove excess mortar that may accumulate on slipformed vertical edges.
- If the slab edge sags, repair immediately by hand forming; do not use concrete mortar to top off the sag. If edge sagging persists, suspend operations and perform corrective measures.

#### **7.4.3.4 Finishing**

- Finish concrete to Section 7.1 - Cement Concrete and Section 7.3 - Concrete for Roadways.
- Continually check the concrete surface while it is still plastic to ensure that surface and grade tolerances are met. Immediately correct excessive variations.

#### **7.4.3.5 Joints**

- CrackControl Joints: formed or tooled, to Section 7.3 - Concrete for Roadways; at 6 m maximum spacing.
- Isolation and Construction Joints: to Section 7.3 - Concrete for Roadways.

#### **7.4.3.6 Protection and Curing**

Protect and cure concrete to Section 7.3 - Concrete for Roadways

#### **7.4.3.7 Backfill Along Alley Edges**

- Backfill areas between alley pavement and parking lots or driveways with specified granular material compacted to a minimum of 97.0% of maximum density according to ASTM D698 Method A.
- Backfill other areas along alley edges with 150 mm of lightly tamped topsoil shaped to match adjacent landscaped areas.

**7.4.3.8 Field Quality Control**

- **Surface:** Maximum variation under a 3 m straightedge:
  - Parallel to the direction of travel: 6 mm.
  - Transverse to the direction of travel: 6 mm.
- **Grade:** ±6 mm maximum variation from designated elevation.
- **Thickness:** At the City's request, the quality assurance laboratory will take one or more sets of cores from suspect concrete base, each set comprising 3 cores whose average thickness represents not more than 500 m<sup>2</sup> of concrete base.
  - **Deficient Thickness:** If the average core thickness is deficient, that area of concrete base will be assessed a pay factor according to Table 7.4.1

**Table 7.4.1: Concrete Base Thickness Pay Factors**

THICKNESS DEFICIENCY (mm)	PAY FACTOR (% of Contract Price)
6	100.0
7	97.0
8	93.7
9	90.0
10	85.5
11	80.5
12	75.0
13	68.0
14	60.0
15	50.0
>15	Remove and replace

- **Excess Thickness:** Concrete base with excess thickness may be accepted if surface and grade tolerances are met, but no claim for additional payment will be accepted

**7.4.3.9 Rejected Concrete Base**

- Remove and replace rejected concrete base by full slabs between transverse and longitudinal joints.

#### **7.4.3.10 Asphalt Surfacing**

- Asphalt surfacing to Section 6.3 - Hot-Mix Asphalt Paving may proceed when the concrete has attained at least 75% of its specified strength, as confirmed by a test on a field-cured cylinder.
- If surfacing cannot proceed on schedule, do not allow vehicular traffic on the new concrete base until cylinder testing has confirmed that the concrete has attained 75% of its specified strength.
- The Contractor shall at the Contractor's expense remove and replace asphalt surfacing if the concrete base requires removal due to unacceptable strength test results.

#### **7.4.3.11 Opening to Traffic**

- Do not open finished pavement to traffic until directed by the City.
- When opening to traffic, leave pavement clean and free of debris and remove signs and barricades no longer required.

## 7.5 CONCRETE PAVEMENT

### 7.5.1 General

#### 7.5.1.1 Content

This section includes the construction of onecourse non-reinforced Cement concrete pavement for streets and alleys.

#### 7.5.1.2 Related Sections

- Aggregate Section 2.1
- Cement Concrete Section 7.1
- Concrete for Roadways Section 7.3
- Concrete Forms and Accessories Section 7.10
- Reinforcing Steel Section 7.12

#### 7.5.1.3 Quality Assurance

- The quality assurance laboratory will conduct slump, air content, nuclear density tests, airvoid examination, strength tests and acceptance criteria to Section 2.1 - Aggregate and Section 7.1 - Cement Concrete.
- **Thickness**

At the City's request, the quality assurance laboratory will take one or more sets of cores from suspect concrete pavement, each set comprising 3 cores whose average thickness represents not more than 500 m<sup>2</sup> of concrete pavement

### 7.5.2 Products

#### 7.5.2.1 Materials

- Concrete Class A to Section 2.1 - Aggregate and Section 7.1 - Cement Concrete.
- Tie bars, reinforcement if required, joint sealant, preformed joint filler, curing compound to Section 7.12- Reinforcing Steel.
- Granular backfill to Section 2.1 - Aggregate, Designation 3 class 20A.

#### 7.5.2.2 Equipment

**Slipform Paver:** To Section 7.10- Concrete Forms and Accessories; equipped with adequate internal vibrators to consolidate concrete to full depth and width of slab; adjustable to crown and crossfall; subject to the approval of the Engineer

### **7.5.3 Execution**

#### **7.5.3.1 Preparation**

- The prepared subgrade or sub-base shall be inspected by the City prior to placing concrete.
- Repair and retest disturbed subgrade or sub-base and remove debris and loose material from the surface.

#### **7.5.3.2 Slipforming**

- Slipform concrete to Section 7.10 - Concrete Forms and Accessories and as supplemented below.
- Remove excess mortar that may accumulate on a slipformed vertical edge.
- If slab edge sags, repair immediately by hand forming; do not use concrete mortar to top off the sag. If edge sagging persists, suspend operations and perform corrective measures.

#### **7.5.3.3 Hand Forming and Placing Concrete**

- On areas impractical for slipforming, place forms, reinforcement if required and concrete to Section 7.1 - Cement Concrete, Section 7.3 - Concrete for Roadways, Section 7.10 - Concrete Forms and Accessories and Section 7.12 - Reinforcing Steel and as supplemented below.
- Place concrete continuously until the scheduled pour is complete. Arrange the rate of concrete delivery to ensure that the discharge interval between successive loads does not exceed 30 minutes. If the discharge interval is exceeded, place a construction joint.

#### **7.5.3.4 FINISHING**

- Finish concrete to Section 7.1 - Cement Concrete and Section 7.3 - Concrete for Roadways. Apply a burlap final finish.
- Continually check the plastic concrete surface to ensure that surface and grade tolerances are met. Immediately correct excessive variations.

#### **7.5.3.5 JOINTS**

- CrackControl Joints

Sawcut, to Section 7.3- Concrete for Roadways, at a 6 m maximum spacing, to the width and depth detailed on the drawings.

- Isolation and Construction Joints

To Section 7.3 - Concrete for Roadways.

#### **7.5.3.6 Protection and Curing**

Protect and cure concrete to Section 7.3 - Concrete for Roadways.

#### **7.5.3.7 Backfill Along Alley Edges**

- Backfill areas between alley pavement and parking lots or driveways with specified granular material compacted to a minimum of 97% of maximum density according to ASTM D698 Method A.
- Backfill other areas along alley edges with 150 mm of lightly tamped topsoil shaped to match adjacent landscaped areas.

#### **7.5.3.8 SITE QUALITY CONTROL**

- **Surface Tolerance**

Maximum variation under a 3 m straightedge:

Mainline parallel to direction of travel: 3 mm

Transverse to direction of travel and at intersections and ramps: 6 mm

- **Grade Tolerance**

Maximum variation from designated grade elevations:  $\pm 3$  mm

- **Correction of Hardened Surface**

The following techniques shall be used to correct excessive variations from flatness or grade once the concrete has set.

- Areas higher than the designated grade from 3 mm to 15 mm: Grind down with an approved machine to within tolerance and not to a polished surface but to a texture as close as possible to a burlap finish.
- Areas exceeding 3 mm below, or exceeding 15 mm above, the designated grade: Remove and replace pavement to the full width between longitudinal joints and not less than 1.5 m in length. If the area extends to within 1.5 m of a transverse joint, replace the pavement to that joint.

- **Deficient Thickness**

If the average core thickness is deficient, that area of concrete pavement will be assessed a pay factor according to Table 7.5.1.



**Table 7.5.1: Concrete Pavement Thickness Pay Factor**

THICKNESS DEFICIENCY (mm)	PAY FACTOR (% of Contract Price)
3	100.0
4	99.5
5	98.6
6	97.4
7	95.6
8	93.2
9	90.0
10	85.5
11	80.5
12	75.0
13	68.0
14	60.0
15	50.0
Over 15	Remove and Replace

- **Excess Thickness**

Concrete pavement with excess thickness may be accepted if surface and grade tolerances are met, but no claim for additional payment will be accepted.

**7.5.3.9 Rejected Concrete Pavement**

Remove and replace rejected concrete pavement by full slabs between transverse and longitudinal joints.

**7.5.3.10 Opening to Traffic**

- Do not open new pavement to vehicular traffic until cylinder testing has confirmed that the concrete has attained 75% of the specified strength, or until directed by the City.
- When opening the new pavement to traffic, leave the pavement clean and free of debris and remove signs and barricades no longer required

## 7.6 CONCRETE PAVING UNITS

### 7.6.1 General

#### 7.6.1.1 Content

This section includes the supply and placement of interlocking concrete paving units on soil cement base for pedestrian and vehicle traffic.

#### 7.6.1.2 Related Sections

- Aggregate Section 2.1
- Concrete for Roadways Section 7.3
- Concrete Base Section 7.4

#### 7.6.1.3 Submittals

- Submit the manufacturer's product data together with 2 samples representative of style, size, colour range and surface texture to the City at least 14 days prior to delivery of concrete pavers on site. Submit further samples as requested by the City.
- Submit source and gradation of bedding and joint sand to the Technical Services Section, Transportation and Streets Department at least 7 days prior to use.

#### 7.6.1.4 Quality Assurance

- The quality assurance laboratory will test paving units for compressive strength and absorption according to ASTM C936.
- Units not meeting specifications shall be replaced.

### 7.6.2 Products

#### 7.6.2.1 Materials

- Concrete Paving Units: manufactured to ASTM C936 and conforming to the following:
  - **Compressive strength at delivery:** minimum 55 MPa average of test samples with no unit less than 50 MPa.
  - **Moisture absorption at delivery:** maximum 5% average of test samples with no unit more than 7%.
  - **Size:** to manufacturer's standard size within a tolerance of  $\pm 2$  mm in length and width.

- **Thickness:** 60 mm or 80 mm as indicated, within a tolerance of  $\pm 3$  mm.
- **Shape and Colour:** as indicated on drawings or as ordered.
- **Bedding Sand:** to Section 2.1 - Aggregate, Designation 4, class 10.
- **Joint Sand:** to Section 2.1 - Aggregate, Designation 4, class 2.5, with 6% bentonite.
- **Edge Restraint:** pressure treated wood, concrete or other material or structure as indicated on drawings.
- **Weed Barrier:** as indicated on drawings.
- **Insulation:** as indicated on drawings.

### 7.6.3 Execution

#### 7.6.3.1 Preparation

- Construct Class B concrete base to Section 7.3 – Concrete for Roadways with the following modified tolerances:
  - Smoothness: 8 mm maximum variation under 3 m straightedge.
  - Grade: 0 mm maximum variation above designated elevation.  
8 mm maximum variation below designated elevation.
- The Class B concrete base shall be inspected by the City before placing bedding sand. Repair imperfections and clean surface of debris and loose material. Do not use bedding sand for corrective levelling.
- **Edge Restraint:** Install as detailed on drawings.
- **Weed Barrier:** Install as detailed on drawings.
- **Insulation:** Install as detailed on drawings.

#### 7.6.3.2 Sand Bedding

- Bedding sand shall have a uniform moisture content of 6% to 8% by mass when spread.
- Spread sand uniformly and screed lightly to achieve a uniform thickness of  $30 \pm 8$  mm after placement and tamping of pavers.
- Alternatively, spread sand in a loose lift of sufficient thickness to achieve 2/3 of the required thickness and lightly tamp with one pass of a plate vibrator. Then spread and screed the remaining lift of loose sand onto which the pavers can be laid.



## 7.7 ROLLER COMPACTED CONCRETE

### 7.7.1 General

#### 7.7.1.1 Content

Production of roller-compacted concrete (RCC) and construction of RCC pavement for roadways, with or without asphalt surfacing.

#### 7.7.1.2 Related Sections

- Aggregate Section 2.1
- Cement-Stabilized Subgrade Section 4.2
- Granular Base Courses Section 5.1.
- SGC Hot-Mix Asphalt Concrete Section 6.1
- SGC Hot-Mix Asphalt Paving Section 6.3.
- Liquid Asphalt Coats Section 6.7.

#### 7.7.1.3 Submittals

- **Mix Design**
  - Submit to the Technical Services Section (ESS), a RCC mix design performed by a qualified laboratory at least 14 days before the initial RCC work and when there is a change in materials, sources or proportions.
  - If requested, provide evidence that the proportions in the mix design will produce RCC of the quality specified. Include strength tests on trial mixes made under plant conditions.

- **Optional Coring Test Results**

Optional coring test results shall be submitted to the Engineer with a copy sent to **the Technical Services Section.**

- **Job-Mix Formula**

Submit to ESS, at least seven days before production, the proportions of materials and plant settings, based on the approved mix design.

#### 7.7.1.4 Quality Assurance

- ESS will conduct the plant checks, sampling and testing described in the following paragraphs.

- **Plant Check**

RCC plant inspections will be conducted at random to check the settings, operation, materials and mixtures produced. The Engineer will order the plant shut down if deficiencies are found, such as deviation from the approved job-mix formula, segregation in the mix, or inconsistent plant operation.

- **RCC Unit Area and Cores**

- RCC pavement will be accepted or rejected, based on a unit area of 1,000 sq. m. or less. The unit area is represented by three cores taken according to A23.2-14C when the RCC is 28 days old. The cores will be measured for thickness and tested for compressive strength.
- Fill the core holes with Cement mortar as directed.

- **Thickness**

- **Required Thickness:** The average thickness of the three cores, taken for a unit area of RCC, shall equal the specified thickness.
- **Deficient Thickness:** A unit area of RCC, represented by a deficient thickness, will be assessed a pay factor according to Table 7.7.2.
- **Excessive Thickness:** A unit area of RCC, with excessive thickness, may be accepted if surface and grade tolerances are met, but without extra payment.
- **Compressive Strength**
- **Procedure:** The 28-day cores will be tested for compressive strength according to CSA A23.2 -9C (current edition). Additional cores may be taken if necessary for a 7-day strength test.
- **Required Strength:** The average compressive strength of three, 28-day cores, taken for a unit area of RCC, shall not be less than 85% of the specified 28-day strength, with no single core strength below 75% of specified strength.
- **Deficient Strength:** A unit area of RCC, represented by a deficient strength, may be accepted subject to a pay factor according to Table 7.7.3. If strength deficiencies persist, the Engineer will also require changes to mix proportions for the remainder of the work. The Contractor is responsible for taking corrective actions in the mix production and placement operations.
- **Optional Coring by the Contractor:** The Contractor has the option, at his expense, to show evidence of strength by coring and testing according to CSA A23.1-14C (current edition), performed by a qualified laboratory within seven days after the failed 28-day core test. Three cores shall be drilled from the RCC unit area represented by a failed core strength test. If the average strength of the three new cores is equal to

85% of the specified strength and on one core is less than 75% of the specified strength, then the specified strength will be considered met. Otherwise, the RCC will be subject to a pay factor as stated in Table 7.7.3 on the basis of the original core strength test.

## 7.7.2 Products

### 7.7.2.1 Materials for RCC

- **Cement**
  - To CSA-A3001, Type GU/GUL/GULb General Use Cement. Submit to the Services Section, the cement manufacturer’s mill test reports monthly or as requested by the Engineer.
- **Fly Ash**
  - To CSA A3001, Supplementary Cementitious Material Type F Type F. Submit to the Technical Services Section, physical test reports monthly or as requested by the Engineer.
- **Water**
  - To Clause 4.2.2, CSA A23.1 (current edition), clear, free from injurious amounts of oil, acid, alkali, organic matter, sediment, or other substance harmful to the mixing and curing of RCC.
- **Aggregates**
  - Normal-density, coarse and fine aggregates, conforming to CSA A23.1 (current edition), modified as follows:
  - **Combined Grading:** Conforming to Section 02060, Designation 1, Class 20.
  - **Gradation Tolerances:** Gradation of the aggregate used in the mix shall match the gradation of samples furnished for the mix design within the following tolerances:

**Table 7.7.1: Gradation Tolerance**

Sieves (µm)	Tolerance (±% Points)
12,500; 10,000	5
5,000; 1,250; 630	4
315; 160	3
80	2

- **Crushed Faces:** Not less than 50%, by mass of the aggregate portion larger than 5,000 mm to have at least two crushed faces.
- **Particle Shape:** Flat particles (length to thickness ratio >5) and elongated particles (length to width ratio >5) not to exceed 15% by mass, of the aggregate portion larger than 5,000 mm, as determined according to CSA A23.2 (current edition).
- **Curing Compound**
  - RCC without Asphalt Surfacing: white pigmented, liquid, membrane-forming compound conforming to ASTM C309, Type 1.
  - RCC with Asphalt Surfacing or with Deferred Asphalt Surfacing: SS-1, emulsified asphalt conforming to Section 6.7 Liquid Asphalt Coats.

### 7.7.2.2 Equipment

- **Mixing Plant**

A central batch concrete plant or a continuous flow mobile concrete plant with a twin shaft pugmill mixer, capable of continuous or batch mixing; equipped with synchronized metering devices and feeders to maintain the correct proportions of aggregate, cement and water; and capable of producing a uniform mixture. The pugmill shall be equipped with a discharge hopper having the capacity of at least one tonne. The discharge hopper shall be equipped with dump gates to ensure rapid and complete discharge without segregation.

- **Paver**

An asphalt type paver modified or equipped with dual tamping bars and vibrating screed, capable of laying down the RCC mix to at least 90% of required density. The paver shall be of suitable weight and stability to spread and finish the concrete without segregation to the required thickness, smoothness, surface texture, cross-section, and grade; subject to approval by the Engineer.

- **Compaction Rollers**

Self-propelled steel drum rollers of the 9-tonne to 18-tonne class, capable of vibratory, primary compaction; self-propelled steel drum or rubber-tired rollers of the 18-tonne class, for static finish rolling; and suitable.

### 7.7.2.3 Mix Designs

- **Cement Content**

A minimum of 13% by mass of dry aggregate.



- **Fly Ash**

Not more than 25% of the cement content may be replaced with fly ash. After September 15, no fly ash shall be used in the mix.

- **Water Content**

Within +2% of optimum moisture content to achieve the maximum density of the mix when compacted and to produce zero slump.

- **Compressive Strength**

A minimum of 30 MPa at 28 days to CSA A23.2 (current edition), or as designated by the Engineer.

### **7.7.3 Execution**

#### **7.7.3.1 Subbase Preparation**

- Prepare the subgrade according to Section 4.1 – Subgrade Preparation, or alternatively stabilize the subgrade with cement according to Section 4.2 – Cement Stabilized Subgrade. If required, construct a granular subbase according to Section 5.1 – Granular Base Course.
- Moisten the surface of the subgrade or subbase, without creating mud or the ponding of water, to minimize absorption of water from the RCC mix to be deposited.

#### **7.7.3.2 RCC Production**

Display the approved job mix formula in sight of the plant operator. Failure to display will result in a shutdown order by the Engineer. Do not make changes to the formula without the Engineer's concurrence.

#### **7.7.3.3 Unsuitable Weather Conditions**

- **Wet Weather**

Do not place RCC during rain or when rain is imminent. Take precautions that a light mist will not result in RCC tracking by the rollers.

- **Cold Weather**

- Do not place RCC on frozen subbase or subgrade, and when ambient air temperature is 5°C and falling, or when 0°C weather is expected within 48 hours.
- Do not place RCC after September 30, unless permitted by the Engineer as a result of favourable weather.

- Protect RCC from freezing for at least seven days.
- **Hot Weather**
  - Provide protective measures from hot-weather and drying conditions, according to Clause 21.2.2, CSA A23.1 (current edition).
  - If the above measures are not effective in preventing plastic cracking of the RCC surface, suspend placement immediately until favourable conditions exist.

#### **7.7.3.4 Placing RCC**

- **Test Strip**

The Contractor shall construct a test strip of thickness, equal to the design thickness with a minimum of 75 tonnes of mix. The strip will be used to resolve anticipated problems with equipment, mix behaviour, compaction, or strength characteristics. The test strip shall be constructed at a location chosen by the Contractor, at least 35 days prior to the start of paving operations. The Contractor shall cooperate fully with the Engineer during the construction and testing of the test strip.

- **Transporting**

Transport the RCC mixture to site in dump trucks with boxes cleaned out before loading, and provided with protective covers, properly secured in place until discharge. The trucks shall dump directly into the hopper of the paver unless placement is by hand as directed by the Engineer. Dumping the RCC mix directly onto the underlying course will not be permitted. Hauling over the freshly placed RCC will not be permitted.

- **Continuity**

Coordinate RCC delivery, so that the mix can be spread and rolled within the appropriate time limit and to ensure uniform progress of the paver until the scheduled spread is complete. The time between mixing and placing the RCC shall not exceed 45 minutes. This time limit may be increased or decreased by the Engineer dependent upon ambient conditions of temperature and humidity.

- **Spreading**

With the paver, spread the mix to a sufficient depth that will produce the specified thickness when compacted and conform to the required cross-section and grade. Operate the paver in a manner that will prevent segregation and produce a smooth, continuous surface without tearing, pulling or shoving. Placing of the RCC mix shall be done in a pattern so that the water from previously placed RCC will not pose a runoff problem on the fresh RCC surface.

- **Segregation**

If segregation occurs, suspend the spreading operation until the cause is determined and corrected. Rake off the segregated, coarse aggregate before rolling. Broadcasting or fanning of the RCC mixture onto areas being compacted is not permitted.

- **Length of Spread**

Limit the length of the RCC spread to that, which can be compacted and finished within the appropriate, time limit under the prevailing air temperature, wind and other climactic conditions.

- **Placing Adjacent Lanes**

Not more than 45 minutes shall elapse between the placement of the RCC in adjacent lanes, unless a cold joint is provided. Joints shall be made to assure a continuous bond between the old and the new sections of pavement. The time limit may be increased or decreased, depending on ambient conditions of temperature and humidity.

### **7.7.3.5 Compaction and Finishing**

- **Required Density**

The Contractor is responsible for achieving 98% of the maximum dry density, when the maximum dry density is defined as the dry unit mass of the sample at the optimum moisture content as determined in the laboratory to ASTM D1557.

- **Start of Rolling**

Begin compaction rolling with fifteen (15) minutes after spreading the RCC mix. Any additional delay will result in the coring of the affected areas at the Contractor's expense to ensure that it meets the requirements of this specification.

- **Rolling Pattern**

Establish a rolling pattern that will achieve the required density with a minimum number of roller passes.

- **Vibratory Rolling**

During vibratory compaction, never let the roller start or stop in vibratory mode. Stagger the stopping point of successive rolling passes to avoid forming a depression on the surface.

- **Surface Check**

Continually check the RCC surface, while still plastic, to ensure surface and grade tolerances are met. Immediately correct excessive variations.

- **Finish Rolling**

Immediately follow vibratory compaction with passes of the rubber-tired roller so that surface voids and fissures are closed to form a tight, surface texture. Remove any roller marks on the surface using a steel drum roller in static mode.

- **Lane Edge**

Each edge of each lane shall be constructed with a vertical or 15 degree from vertical configuration.

### **7.7.3.6 Small Areas**

- Spread the RCC mix by hand in areas not accessible by the paver, as directed by the Engineer.
- Compact the mix to the required density using suitable, vibratory compaction equipment.

### **7.7.3.7 RCC Joints**

- **Fresh Joint**

A fresh joint is made when an adjacent RCC lane is placed within 45 minutes after placing the previous lane. Ensure that the contact face is vertical. Before rolling, hand-finish the joint as necessary to produce a tight surface. Roll extra passes, as necessary, to achieve the required density and smoothness in the joint area.

- **Cold Joint**

A cold joint is made when an adjacent RCC lane is placed more than 45 minutes after placing the previous lane. Sawcut the edge of the previous lane back to sound RCC to form a vertical face. Trimming by grader blade may be permitted if done at the end of the workday or first thing the following morning. Dampen the vertical face just before placing the fresh RCC against it. Before rolling, hand-finish the joint, as necessary, to produce a tight surface. Roll extra passes, as necessary, to achieve the required density and smoothness in the joint area. Every effort shall be made to maintain longitudinal joints as a fresh joint as described in Clause 7.7.3.5 above. Longitudinal, cold joints shall be avoided at all times.

- **Transverse Joint**

May be a fresh or a cold joint.

### 7.7.3.8 RCC Curing

- **RCC without Asphalt Surfacing**

Keep the RCC surface continuously moist by water or fog spray, or wet burlap, for a minimum of seven days before applying the curing compound. Apply the specified membrane-forming, curing compound at a rate of not less than 0.25 litre/m<sup>2</sup> of surface, ensuring that a continuous, void-free membrane is formed.

- **RCC with Asphalt Surfacing (within 24 hours)**

Immediately after final rolling, apply the SS-1 liquid asphalt coating, according to Section 6.7 at a rate of 0.5 ± 0.2 litre/m<sup>2</sup> of surface.

- **RCC with Deferred Asphalt Surfacing**

Keep the RCC surface continuously moist by water or fog spray, or wet burlap, for a minimum of seven days before applying the SS-1 liquid asphalt coating, according to Section 6.7, at a rate of 0.5 ± 0.2 litre/m<sup>2</sup> of surface, ensuring that a continuous, void-free membrane is formed.

### 7.7.3.9 Backfill

Backfilling of the edge of the RCC pavement shall not commence prior to the approval of the Engineer. Backfill shall be done in accordance with Section 2.3 – Grading.

### 7.7.3.10 Quality Control

- **Surface Tolerances**

A 6 mm maximum variation, under 3 m straightedge. Surface texture shall be tight.

- **Grade Tolerances**

A 3 mm maximum variation above designated elevation, a 9 mm variation below designated elevation.

### 7.7.3.11 Defective RCC

- **Repairs**

All repairs are subject to the Engineer's approval. Correct deficiencies while the RCC is still plastic; otherwise, repair after seven days. After seven days, the RCC shall be removed by sawcutting full-depth before removal. Replace the RCC utilizing Cast-in-Place concrete which meets the requirements of Section 03060, Class B Concrete. The new concrete shall be doweled into the existing RCC utilizing epoxy-coated, 15M reinforcing bars.

- Remove and replace the RCC if surface cracks, wider than 15 mm, occur after seven days.
- Remove and replace the RCC if deficient in thickness by more than 10% of the specified total thickness.
- Remove and replace the RCC if the compressive strength is under 80% of specified strength.
- Grind off, high surface variations to a finish acceptable by the Engineer.
- Filling low areas with fresh RCC is not permitted.
- If asphalt surfacing is specified, low areas shall be made up with additional surfacing material without extra payment.

#### **7.7.3.12 Asphalt Surfacing**

- Do not allow traffic, except for the water truck, on the RCC until it has cured for at least seven days or as directed by the Engineer.
- If specified, asphalt surfacing according to Section 3.2 – Utility Cut Restoration may proceed after seven days of curing of the RCC or as directed by the Engineer.
- The Contractor shall, at his expense, remove and replace asphalt surfacing if the RCC pavement has to be removed and replaced because of unacceptable thickness or strength.

**Table 7.7.2: RCC Thickness Pay Factors**

THICKNESS DEFICIENCY (% of Total Thickness)	PAY FACTOR (% of Contract Price)
4.8	100.0
5.2	97.0
5.8	93.7
6.4	90.0
7.0	85.5
7.6	80.5
8.2	75.0
8.8	68.0
9.4	60.0
10.0	50.0
Over 10.0	Remove and Replace

**Table 7.7.3: RCC Strength Pay Factors**

CORE STRENGTH (% of Specified Strength)	PAY FACTOR (% of Contract Price)
85.0	100.0
84.5	97.5
84.0	95.0
83.5	92.5
83.0	90.0
82.5	87.5
82.0	85.0
81.5	82.5
81.0	80.0
80.5	77.5
80	75.0
Under 80.0	No Payment

## 7.8 PATTERNED CONCRETE SLAB

### 7.8.1 General

#### 7.8.1.1 Content

This section includes the supply of materials and construction

#### 7.8.1.2 Related Sections

- Cement Concrete Section 7.1
- Concrete for Roadways Section 7.3
- Concrete Pavement Section 7.5
- Concrete Sidewalk, Curb and Gutter, and Slabs Section 7.2

### 7.8.2 Products

#### 7.8.2.1 Materials

- **Concrete:** to Section 7.1 - Cement Concrete and Section 7.3 - Concrete for Roadways, modified as follows:
  - For hand-placed concrete, a slump of 80 ±20 mm is allowable for Classes A and C.
- **Colouring Agent:** iron oxide pigments conforming to ASTM C979, colours as designated on plans and approved by the City. The pigment shall be added during concrete mixing to produce a uniform colour throughout the pavement or walk/slab.
- **Release Agent:** generally consisting of talc, colour, binder and bentonite-like material; shall be kept absolutely dry prior to use so it can be powdered on; shall be capable of preventing adhesion of stamping tools to the concrete surface, preventing loss of entrained air from the surface and being power-washed off when the concrete has partially cured.
- **Curing Agent:** to ASTM C309, type I, class B, clear, resin based.
- **Concrete Sealer:** apply a proprietary slip resistant sealer to the concrete surface in accordance with the manufacturer's recommendations.
- **Concrete Stamping Tools:** capable of stamping the specified pattern and texture.



### 7.8.2.2 Mix Design

- Submit a concrete mix design to Section 7.3 - Concrete for Roadways and including the following:
- The brand and colour of colouring agent used.
- The amount of colouring agent expressed as a percentage by mass of cement in the mix (10% maximum).
- The amount of entrained air adjusted as may be required by the type of colouring agent used.
- Confirmation that no admixtures containing calcium chloride will be used.
- Relevant information on reinforcing fibres, if used.

### 7.8.2.3 Quality Control

Prior to installing patterned colored concrete, provide a 2.5 m x 2.5 m mock-up at the job site for the City's approval of colour, pattern, texture and workmanship. The approved mock-up shall serve as a standard for judging the completed work.

## 7.8.3 Execution

### 7.8.3.1 Concrete Placement

- **Concrete Pavement:** to Section 7.5 - Concrete Pavement.
- **Concrete Walk:** to Section 7.2 – Concrete Sidewalk, Curb and Gutter, and Slabs.
- **Curb Ramp:** to Section 7.2 - Concrete Sidewalk, Curb and Gutter, and Slabs; surface finish according to standard drawings. No stamped pattern is permitted.
- **Manhole, Valve and Other Fixtures:** Concrete pavement around such fixtures shall be poured separately using isolation joints as detailed on drawings. Isolation joints are not required on concrete walk or other slabs.

### 7.8.3.2 Installing Patterned Concrete Surface

- **Temperature:** When colour additives are used, a minimum air temperature of 8°C in shade is required. If dark pigmentation is used, the maximum air temperature shall not exceed 27°C in shade.
- **Surface Float:** Float the concrete surface instead of applying a burlap or broom finish.
- **Release Agent Application:** Before using the stamping tool, apply the specified release agent according to manufacturer's specifications.

- **Polyethylene Sheet:** If appropriate for the work, a polyethylene sheet may be used in lieu of a release agent to prevent the stamping tool from adhering to the concrete surface. Carefully cover the floated concrete surface with the sheet. After stamping and while the surface is still plastic, carefully remove the sheet and apply a brush finish if specified.
- **Stamping:** While the concrete is still in its plastic state, impress the specified pattern on the surface using the stamping tools. Tamp the tools properly into the surface to achieve the desired texture.
- **Pavement Joints:** Sawcut and seal pavement joints to Section 7.3 - Concrete for Roadways. Immediately remove excess release agent, sawcut debris and stains.
- **Walk or Slab Joints:** These joints may be hand-tooled to Section 7.2 – Concrete Sidewalk, Curb and Gutter, and Slabs before applying release agent and stamping. Remove excess release agent and stains before applying the curing seal.
- **Curing:** Apply at least one coat of the specified curing seal to the dry concrete surface according to the manufacturer's specifications.

#### **7.8.3.3 Workmanship**

- The concrete work is subject to the same tolerances and quality assurance as specified in Section 7.5 - Concrete Pavement, or Section 7.2 - Concrete Sidewalk, Curb and Gutter, and Slabs.
- The patterned concrete surface shall be uniform in colour, pattern and texture, conforming to the approved job mock-up.
- The patterned concrete surface shall exhibit no efflorescence, discoloration and other defects for a period of 24 months after placement. Any such defects occurring during that period shall be remedied before final acceptance of the work.

#### **7.8.3.4 Open to Traffic**

- Do not open the completed work to traffic until cylinder testing has confirmed that the concrete has attained 75% of its specified strength, or until directed by the City.
- Before opening to vehicle traffic, clean all debris from the pavement, walk or slab and remove signs no longer required.

#### **7.8.3.5 Tools for Repair**

Provide stamping tools of the specified patterns to the City for the sole purpose of repair work when maintenance of the work is assumed by the City, unless otherwise directed by the City.

## 7.9 ULTRATHIN WHITETOPPING

### 7.9.1 General

#### 7.9.1.1 Content

This section includes the requirements for the construction of Ultra-thin Whitetopping of existing asphalt pavement and additional requirements for concrete mix design, quality control, quality assurance, and placement for pavement and associated structures.

#### 7.9.1.2 Related Sections

- Pavement Cold Milling Section 6.6
- Cement Concrete Section 7.1
- Concrete Forms and Accessories Section 7.10
- Reinforcing Steel Section 7.12

#### 7.9.1.3 Submittals

- Submit to the Technical Services Section a mix design for each designated class of concrete at least 14 days prior to initial concrete work and when there is a change in materials, sources or proportions.
- Submit a complete petrographic analysis of the aggregate proposed for use with the concrete mix design.
- Submit the results of ironstone determination to the Technical Services Section at least once per week.
- Submit test results on concrete with fly ash with the mix design.
- Optional core strength test results shall be submitted to the Engineer with a copy to the Technical Services Section.

#### 7.9.1.4 Quality Assurance

To Section 7.1– Cement Concrete.

#### Quality Control

- The supplier shall conduct a quality control program that will ensure their concrete product meets the specifications. The supplier shall provide test results, if requested by the Engineer. The quality control program should be conducted at the plant with corresponding spot checks at the jobsite. Construction sites are not to be used as

reactionary quality control points by the supplier to deficiencies in the supplied product through excessive or continuous re-tempering of the mix.

- A technician certified by CSA or ACI shall perform quality control testing initiated by the supplier.

## 7.9.2 Products

### 7.9.2.1 Materials

- **Cement:** To Section 7.1 – Cement Concrete.
- **Aggregates:** To Section 7.1 – Cement Concrete, and as supplemented below:
  - **Petrographic Analysis:** To be performed by a qualified laboratory to the “Procedures for the Petrographic Analysis of Coarse and Fine Aggregate (Ontario)”, which is available from the Technical Services Section, Integrated Infrastructure Services.
  - **Ironstone Content:** To be performed by an approved facility to the Method for Ironstone Content Determination in Fine and Coarse Concrete Aggregates, available from the Technical Services Section, Integrated Infrastructure Services. Do not use aggregate until the Engineer has reviewed the corresponding results. Ironstone content in coarse aggregate shall not exceed 1.0% by mass of the total coarse sample (retained on the 5 mm sieve and up), and in fine aggregate shall not exceed 1.5% by mass of the total fine sample (passing the 5 mm sieve to that retained on the 2.5 mm sieve). Any concrete supplied with aggregates exceeding the specified ironstone content will be rejected, and shall be removed by the Contractor as directed by the Engineer.
- **Water:** To Section 7.1 Cement Concrete.
- **Fly Ash:** For Class A, B, and C concrete not more than 10% of the specified minimum cement content may be replaced with fly ash from May 15 until September 30 unless not permitted by the City Engineer.
- **Sulphate Resistant Concrete:** Concrete utilizing cement with less than 4.0% C<sub>3</sub>A shall not be placed after September 30, for Class A, B, and C concrete.
- **Curing compound:** to ASTM C309, type 2, class B, white pigmented, resin based, liquid membrane-forming compound.
- **Synthetic Fibers:** to ASTM C1116. Fibers must provide a residual strength of at least 0.6 Mpa as measured by ASTM C 1399.
- **Preformed Joint Filler:** to ASTM D1751.
- **Joint Sealant:** to ASTM D1190, hotpoured elastic type.

- **Forms:** To Section 7.10 – Concrete Forms and Accessories.
- **Reinforcement:** To Section 7.12 – Reinforcing Steel.

### 7.9.2.2 Mix Design

- For Ultra-thin Whitetopping the concrete mix shall be designed to meet the following performance criteria:
  - CSA A23.1 Table 2 Class C1 Exposure
  - Maximum Water/cementing materials ratio: 0.40
  - Air Content 6.0 +/- 1%
  - Minimum Compressive Strength:
    - 20 MPa at 2 days
    - 35 MPa at 28 days
  - Slump 70 +/- 20mm
  - kg/m<sup>3</sup> Synthetic Fiber
  - Minimum toughness Performance Level III at 7 days to ASTM C1018.

If the above class of concrete is to be placed by pumping, the specified slump and air limits shall be met at pump discharge.

- **Seasonal concrete mix requirements:**
  - Spring Mixes – from the commencement of the construction season to May 15 or as defined by the Engineer
  - No replacement of the minimum cement content with fly ash (Clause 7.9.2.1 Fly Ash) is permitted.
  - Summer Mixes – May 16 to September 30
  - No more than 10% of the specified minimum cement content may be replaced with fly ash.
  - Fall Mixes – October 1 to October 15
  - No replacement of the minimum cement content with fly ash is permitted (Clause 7.9.2.1 Fly Ash) and cements with less than 4.0% C<sub>3</sub>A cannot be used (Clause 7.9.2.1 Sulfate Resistant Concrete).

- Cold Weather Mixes – October 16 to the end of the construction season, or as defined by the Engineer

Meet the requirements for cold weather concrete in below.

- **Cold weather concrete:**

- All Concrete placed after October 15 shall attain a compressive strength of 27.0 MPa in 7 days and shall be provided with cold-weather protection in accordance with CSA-A23.1.
- High early strength concrete placed after October 15 shall attain a compressive strength of 30.0 Mpa in 7 days and shall be provided with cold-weather protection in accordance with CSA-A23.1.
- Protection as described in CSA A23.1 shall be adequate to maintain concrete surface
- For slipformed (machine placed) concrete, limit slump as follows:
  - 20 ± 10 mm for curb, curb and gutter and New Jersey barrier, and
  - 30 ± 10 mm for walk, monolithic walk and pavement.
- HE/HEL or HS/HSL\*\* cement may be substituted for GU/GUL cement, except as defined in Clause 7.9.2.1 Materials – Sulphate Resistant Concrete.
- Class A, C and E concrete may be subjected to air-void examination.
- Concrete mix designs shall be performed by a qualified laboratory or by a concrete supplier with the capability and a facility approved by the Engineer.
- If requested, provide evidence that proportions in the mix design will produce concrete of the quality specified. Include strength tests on trial mixes made under plant conditions.
- Concrete production may not proceed until the City Engineer has approved the applicable mix design.

### 7.9.3 Execution

#### 7.9.3.1 Asphalt Surface Preparation

- Mill existing asphalt surface to the depth indicated on the project drawings to Section 6.6 – Pavement Cold Milling.
- Sawcut the longitudinal and transverse edges of the scarified asphalt to provide a vertical face.

- Mechanically sweep the roadway clean of all loose or foreign material (i.e. dirt in a subsidence, grass along a gutter face, grindings, etc.). The Contractor shall dispose of all sweepings.
- Water and air blast the surface of the roadway clean of all loose or foreign material.

#### **7.9.3.2 Formwork**

- Set, align and brace forms to Section 7.10 - Concrete Forms and Accessories.
- Apply form release agent to inside face of forms prior to placement of the concrete. Do not apply form release agent to the prepared asphalt surface.

#### **7.9.3.3 Placing Fixed Formed Pavement**

- Deposit concrete directly from the transporting equipment onto the prepared dry asphalt surface.
- Do not place concrete when the asphalt surface temperature is less than 0° C.
- Deposit the concrete between forms to a uniform height.
- Vibrate concrete to remove voids and air pockets. Do not move the concrete horizontally with the vibrator.
- Strike off concrete between forms using a form riding paving machine or vibrating screed. Vibrate the surface of the concrete at a frequency of no less than 3500 vibrations/minute.

#### **7.9.3.4 Placing Slipform Pavement**

- Slipform paving equipment can be used. Furnish machines capable of spreading, consolidating, screeding and finishing concrete in one pass.
- Deposit concrete in accordance with Section 7.9.3.3.
- Produce a dense and homogeneous concrete overlay requiring minimal hand finishing by vibrating the surface of the concrete with a pan vibrator operating at a frequency of no less than 3500 vibrations/minute.

#### **7.9.3.5 Finishing**

- Finish concrete to Section 7.1 – Cement Concrete, and as supplemented below:
- **Tine Finish:** Tine the surface in the transverse direction to a depth of 3 to 6 mm and individual tine width of 2.5 to 3.5 mm. Space tines randomly at a minimum spacing of 13 mm apart, a maximum spacing of 38 mm apart, with no more than 50% of the tines apart by more than 25 mm.

### 7.9.3.6 Joints

- Construct joints at a minimum 1.2-meter spacing as required in each type of construction to the following standards as applicable.
  - The minimum angle between any two intersecting joints shall be 80 degrees.
  - Joints shall intersect the pavement free edges at a 90-degree angle and shall extend straight for a minimum of 0.3 m from the pavement edge.
  - Align joints of adjacent panels.
  - Minimum joint depth shall be 25 mm or one-fourth of the Ultra-thin Whitetopping thickness.
- **CrackControl Joints:** intended to control the location of shrinkage cracks in hardening concrete. Construct joints to the indicated dimensions, spacing, and pattern by sawcutting of the fresh concrete
  - **Sawed Joint:** Cut the groove with a concrete saw as soon as the concrete surface has hardened sufficiently to resist raveling as the cut is made, but before shrinkage cracks form in the concrete. The Contractor is responsible for the proper timing of the saw cut. Immediately flush the saw cut clean with water.
- **Isolation Joint:** required where concrete is placed adjacent to an immovable structure or where indicated on the Drawings. Construct the joint by sawing or forming to create a clean break through the full crosssection of the concrete member. Make the joint wide enough to permit a snug fit for the pre-formed joint filler. Alternatively, place the pre-formed joint filler against the structure and pour the concrete against the pre-formed joint filler.
- **Construction Joint:** required between concrete pours or for joining new concrete to existing work. Construct the joint with a keyway, dowels or tie bars as detailed on the drawings or as directed by the Engineer. Finish edges to a 6-mm radius. Vertically trim the existing concrete by sawing at least 50 mm deep and breaking. Leave the joint form in place until the concrete has set, then remove the joint form without damaging the concrete.

### 7.9.3.7 Protection and Curing

- Protect freshly placed concrete from premature drying, temperature extremes, adverse weather conditions, and physical disturbance to CSA A23.1, and as supplemented below:
- **Moist Curing:** Use where specified or directed by the Engineer. After the concrete has set, maintain exposed surfaces continuously moist using wet burlap or polyethylene film in contact with the concrete for a minimum of 48 consecutive hours after placing.



### 7.9.3.8 Opening to Traffic

Open the pavement to vehicular traffic after the concrete compressive strength exceeds 20.7 MPa or when accepted for opening to traffic.

### 7.9.3.9 Field Quality Control

- The contractor and the concrete supplier shall assist the field technician in obtaining samples for quality assurance testing.
- The contractor shall suspend pouring operations after sampling until the results of the field quality tests are known.

- **Deficient Slump**

For any load of concrete, if the measured slump is outside the specified limits, a check test is taken on another portion of the load, or a retest is done if re-tempering with water is permitted by the Engineer. If the second test fails, the Engineer may reject that load of concrete including removal of the portion already poured.

- **Deficient Air Content**

- For any load concrete, if the tested air content is outside the specified limits, the Engineer will require one of the following:
- Air content below 5.0%: Concrete poured from the load shall be removed and the rest of the load shall be discarded.
- Air content above 7.0%: Concrete poured from the load shall be removed and the rest of the load discarded.
- If the measured air content is below the specified minimum air content, then the contractor may elect to re-temper with air entraining agents in accordance with Section 7.1 - Cement Concrete, Clause 7.1.3.2 Re-tempering with Air-Entraining Admixtures.
- **When Air Void Examination Is Required:** The quality assurance laboratory will drill cores from the hardened concrete for air void examination to Section 3.1
- Cement Concrete, Clause 7.1.1.4 Quality – Air-Void Examination at a frequency of at least one core for each 2,000 m of residential and collector sidewalk, curb and gutter or monolithic walk, curb and gutter, or as requested by the city for arterial, industrial or commercial streets or small residential subdivisions.
- Where concrete has been rejected and is to be removed for not meeting the spacing factor requirement in Section 3.1

- Cement Concrete, Clause 7.1.1.4 Quality Assurance – Air-Void Examination, the Contractor at the Contractor’s expense shall prove that the concrete left in place at both ends of the removal meets the specified spacing factor by air void examination to be performed by a qualified laboratory to Section 3.1
- Cement Concrete. The test results shall be submitted to the Engineer.
- **Deficient Strength**
  - Concrete work for roadways represented by a strength test result which is less than specified may be accepted subject to a pay factor according to Table 7.9.1. If strength deficiencies persist, the Engineer will require changes in the concrete mix design for the remainder of the work.

**Table 7.9.1: Concrete Strength Pay Factors**

CYLINDER STRENGTH (% of Specified Strength)	PAY FACTOR (% of Contract Price)
97.0	100.0
96.0	99.2
95.0	98.2
94.0	96.9
93.0	95.4
92.0	93.6
91.0	91.7
90.0	89.4
89.0	86.7
88.0	83.5
87.0	79.7
86.0	75.5
85.0	70.0
Under 85.0	No Payment

- **Optional core strength test:**

The Contractor has the option at the Contractor’s expense of providing evidence of strength by coring and testing to CSA A23.214C by a qualified laboratory within 7 days of a failed 28-day cylinder test or within 3 days of a failed 7-day cylinder test. Three cores shall be drilled from the hardened concrete represented by the failed cylinder strength tests at locations approved by the Engineer.

The average strength of the 3 cores shall equal 100% of the specified cylinder strength; otherwise, the concrete will be subject to the pay factors of Table 7.9.1 on the basis of the cylinder strength tests alone.

No reduction in the specified 28-day strength for cold weather or air content will be applied to the core strength test results when high early strength concrete is specified.

## 7.10 CONCRETE FORMS AND ACCESSORIES

### 7.10.1 General

#### 7.10.1.1 Content

This section includes the supply of all labour, materials and equipment to complete the concrete formwork and falsework, including slipforming required for the work as indicated on the drawings or specified herein.

#### 7.10.1.2 Related Sections

- Reinforcing Steel Section 7.12
- Concrete for Water and Drainage Structures Section 03310 – Volume 3: Drainage

#### 7.10.1.3 Quality Assurance

- At least one person thoroughly familiar with the type of material being installed, the referenced standards and the requirements of this section shall direct this portion of the Work.
- Supply, erect and dismantle concrete formwork and falsework in accordance with CSA A23.1 except where specified elsewhere.
- The design of all formwork, falsework, scaffolding, shoring, etc. shall be the responsibility of the Contractor.
- Supply, erect and dismantle falsework in accordance with CSA S269.1 except where specified elsewhere.

### 7.10.2 Products

#### 7.10.2.1 Materials

- **Formwork Materials:** comply with CSA S269.3, plain reusable precoated plywood sheets or formed steel panels.
- **Falsework Materials:** comply with CSA S269.1.
- **Form Ties:** use removable or snap-off metal ties, fixed or adjustable length, free of devices leaving holes larger than 25 mm diameter in the concrete surface.
- **Form Release Agent:** chemically active release agents containing compounds that react with free lime in concrete resulting in water insoluble soaps.
- **Void Forms:** expanded polystyrene ‘Frost Cushion’ by Beaver Plastics, or equal.

- **Form Stripping Agent:** colourless mineral oil, free of kerosene, with viscosity between 15 to 24 mm<sup>2</sup>/s at 40°C, flashpoint minimum 150°C, open cup.
- All other materials, not specifically described but required for proper completion of concrete formwork, falsework, scaffolding, or shoring shall be as selected by the Contractor, subject to the advance approval of the Engineer.
- **Slipform Equipment:** of a design suitable to the type of work being constructed, for use with vibrators, and capable of uniformly extruding, spreading, shaping, and consolidating fresh concrete to produce a dense homogeneous mass with surfaces requiring a minimum of hand finishing; self-propelled and capable of automatically controlling alignment and grade from taut wires or string lines.

### 7.10.3 Execution

#### 7.10.3.1 Fabrication and Erection

- Verify lines, levels and centres before proceeding with formwork and falsework, and ensure dimensions agree with drawings.
- Obtain Engineer's approval for use of earth forms.
- Hand trim sides and bottoms and remove loose earth from earth forms before placing concrete.
- Fabricate and erect falsework in accordance with CSA S269.1.
- Do not place shores and mud sills on frozen ground.
- Provide site drainage to prevent washout of soil supporting mud sills and shores.
- Fabricate and erect formwork in accordance with CSA S269.3 to produce finished concrete conforming to shape, dimensions, locations and levels indicated within tolerances required by CSA A23.1.
- Align form joints and make watertight. Keep form joints to a minimum.
- Use 25 mm chamfer strips on external corners and 25 mm fillets at interior corners of concrete members, unless specified otherwise.
- Form chases, slots, openings, drips, recesses and expansion and control joints as indicated.
- Build in anchors, sleeves, and other inserts required to accommodate work specified in other sections. Assure that all anchors and inserts will not protrude beyond surfaces designated to receive applied finishes, including painting.

### **7.10.3.2 Slipforming**

- Set and maintain grade line by establishing taut string line or wire, based on Engineer's survey control datum.
- Provide stable support for travelling slipform machine. Protect adjacent work and repair if damaged.
- Coordinate concrete delivery and placing to ensure uniform progress of slipform machine without stoppage. If machine is stopped for any cause, immediately stop vibrating and tamping elements.
- Maintain proper slump to ensure slipformed concrete does not sag.
- Slipformed surfaces shall be smooth, dense, and free of pockets and honeycomb. Apply a minimum of hand finishing to correct minor irregularities.

### **7.10.3.3 Form Removal**

- Review the proper timing of form removal with the Engineer in all cases.
- Loosen all wall or beam side forms within the first 24 hours after placing for the purpose of spraying water between the concrete and the forms. Strip wall and column forms within 48 hours to facilitate finishing.
- Remove underside of slab or beam forms only after 28 days, or after concrete has attained a minimum of 75% of the specified 28 day strength, with results indicated by field cured test cylinders, and only as approved by the Engineer.
- Reshoring to remove forms will be permitted provided it is in accordance with CSA S269.1.

### **7.10.3.4 Construction Joints**

- Prior to commencing construction, the Engineer shall approve, in writing, the locations of all construction joints required for construction but not shown on the drawings.
- Construct joints in accordance with the details shown on the drawings.
- Roughen all formed construction joints to expose the aggregate of the hardened concrete. Method of roughening to remove laitance to be approved by the Engineer. Alternatively, apply a suitable retardant to the forms of the construction joint and remove retarded surface mortar with low pressure jets of water or stiff brushes.
- No vertical construction joints will be allowed within 3 m of wall intersections without prior written approval from the Engineer.

- Limit the length of any single wall pour to a maximum of 18 m and allow a minimum of seven days before placing any adjoining sections

## 7.11 FILLCRETE

### 7.11.1 General

#### 7.11.1.1 Content

This section includes the production and supply of unshrinkable fill (fillcrete) to be used for trench backfill.

#### 7.11.1.2 Submittals

- Submit a mix design to the Technical Services Section, Integrated Infrastructure Services, at least 14 days prior to initial fillcrete production. The mix design shall be performed by a qualified laboratory, or by the supplier, if approved by the Engineer.
- The supplier shall notify the Technical Services Section, Integrated Infrastructure Services, and shall resubmit a mix design whenever there is a change in materials, sources, or proportions.
- If requested, the supplier shall provide proof that the proportions in the mix design will produce fillcrete of the quality specified.
- No fillcrete shall be produced until the applicable mix design has been approved.

#### 7.11.1.3 Quality Assurance

- The supplier shall provide access to permit the inspection of equipment, materials and processes used in the production and delivery of fillcrete and to obtain samples for testing.
- Quality assurance sampling and testing for slump, air content and compressive strength shall be performed as follows:

- **Slump Tests:**

**Methods:** to CSA A23.21C and CSA A23.25C.

**Test Frequency:** Slump tests shall be taken between the 10% and 90% points of discharge of a fillcrete load with every strength test and as required by the Engineer.

- **Air Content Tests:**

**Methods:** to CSA A23.21C and CSA A23.24C.

**Test Frequency:** Air content tests shall be taken between the 10% and 90% points of discharge of a fillcrete load with every strength test and as required by the Engineer.



- **Strength Tests:**

**Methods:** to CSA A23.23C and CSA A23.29C.

**Test Frequency:** Standard tests for strength shall be conducted at a frequency of not less than one strength test per day per supplier, or as required by the Engineer.

NOTE: Use of 100mm x 200mm (4"x8") waxed cardboard moulds meeting ASTM C31, C39, C192, C470, C496; and AASHTO T22, T23, T126, and T198 is acceptable.

NOTE: Use of sulphur cement capping compound is acceptable for capping Cementitious Low Strength Materials (CLSM). If sulphur cement is used, oil should be placed on the capping plate to ensure release of the capping material from the capping plate. More oil may be required on the capping plate when capping CLSM cylinders than is normally used when capping concrete cylinders, capped CLSM cylinders will normally contain more air voids between the cap and the cylinder than capped concrete cylinders, and this should be considered if the caps are tapped to check for voids.

NOTE: Where it is not feasible to facilitate initial curing on site, samples may be placed in a sealed container to protect the sample from evaporation and contamination. Samples shall be expediently transported to the nearest laboratory within City limits where appropriate facilities are available for casting and protecting the samples during initial curing in accordance. Casting of moulds should occur as quickly as possible after samples are obtained.

## 7.11.2 Products

### 7.11.2.1 Materials

- **Cement:** to CSA A3000 of the following types.
  - Type GU/GUL/GULb – General use cement
  - Type HE/HEL - High early-strength cement
  - Type HS/HSL/HSLb\*\* – High sulphate-resistant cement
- **Fine Aggregate:** to CSA A23.1
- **Water:** to clause 4.2.2, CSA A23.1, clear, free from injurious amounts of oil, acid, alkali, organic matter, sediment, or other substance harmful to the mixing and curing of concrete.

- **Air-Entraining Admixture:** to ASTM C260. Chemical Admixtures: to ASTM C494, including water-reducing agents, retarders and accelerators. Chemical admixtures shall not be used unless permitted in writing by the Engineer.
- **Fly Ash:** to CSA-A3000 Supplementary Cementitious Material Type F.

**7.11.2.2 Mix Design**

Supply fillcrete in accordance with the following Table 7.11.1 or 7.11.2:

**Table 7.11.1: Fillcrete Requirements**

Compressive Strength at 28 Days (MPa)	Slump (mm)	Entrained Air (% by volume)	Maximum Aggregate Size (mm)	Minimum Cement (kg/m <sup>3</sup> )
Minimum - 0.15 Maximum - 0.40	100 ± 25	Min 3.0	5	30

**Table 7.11.2: Pumpable Fillcrete Requirements**

Compressive Strength at 28 Days (MPa)	Slump (mm)	Entrained Air (% by volume)	Maximum Aggregate Size (mm)	Minimum Cement (kg/m <sup>3</sup> )
Minimum - 0.7 Maximum - 2.0	200 ± 50	Min 3.0	5	30

**7.11.3 Execution**

**7.11.3.1 Production and Delivery**

- Fillcrete shall be produced in accordance with CSA A23.1 and shall conform to the approved mix design.
- Prior to loading fillcrete onto rotating drum trucks, the supplier shall ensure that the drum is clean and free of any paste or concrete materials remaining from previous concrete batches

**7.11.3.2 Production Facilities**

- The supplier shall maintain a minimum stockpile of 100 tonnes of cement powder at the production plant site at all times.
- Suppliers shall have a computerized batching system that provides computer printed reports and load tickets or Electronic Tickets. Hand written loading times will not be accepted.

- Plant scale certification shall be maintained to CSA A23.1.

#### **7.11.3.3 Protection of Finished Work**

- Protect fillcrete from freezing or other adverse weather conditions for a minimum of 24 hours after placement.
- Fillcrete that is exposed to significant infiltration of water within 24 hours of placement must be removed and replaced.
- A minimum 150mm granular base course must be placed on the fillcrete surface before allowing any vehicular traffic over the fillcrete. The granular base course must be placed to Section 5.1 - Granular Base Course, a minimum of 24 hours after fillcrete placement.

#### **7.11.3.4 Field Quality Control**

- The City will conduct an initial plant inspection prior to the production of any fillcrete. This inspection shall include, but not be limited to, an inspection of production and quality control facilities, as well as a review of supplier's quality control program.
- **Required Strength**

The result of each compressive strength test shall be within the specified compressive strength range.

## 7.12 REINFORCING STEEL

### 7.12.1 General

#### 7.12.1.1 Content

This section includes the supply of all labour, materials and equipment to complete the reinforcing steel required for the work, as indicated on the drawings or specified herein.

#### 7.12.1.2 Related Sections

- Concrete for Water and Drainage Structures Section 03310 – Volume 3: Drainage
- Concrete Forms and Accessories Section 7.1

#### 7.12.1.3 Quality Assurance

- At least one person thoroughly familiar with the type of material being installed, the referenced standards and the requirements of this section shall direct this portion of the Work.
- Install steel reinforcement in accordance with CSA A23.1 and CSAW186.
- Upon request, provide the Engineer with a certified copy of the mill test report of the proposed reinforcing steel, showing physical and chemical analysis, a minimum of 2 weeks prior to ordering of reinforcing steel, or as necessary to facilitate a review.
- Upon request, inform the Engineer of the proposed source of material to be supplied.

#### 7.12.1.4 Submittals

- Submit shop drawings, including placing of reinforcement.
- Indicate on shop drawings, bar bending details, lists, quantities of reinforcement, sizes, spacing, location of reinforcement and any mechanical splices (only if approved by the Engineer), with identifying code marks to permit correct placement without reference to structural drawings. Indicate sizes, spacing and locations of chairs, spacers and hangers.
- Prepare reinforcement drawings in accordance with the Reinforcing Steel Manual of Standard Practice - by the Reinforcing Steel Institute of Canada, or ACI 315 and ACI 315R, Manual of Engineering and Placing Drawings for Reinforced Concrete Structures.
- Detail lap lengths and bar development lengths to CSA A23.3.
- Locate laps in coordination with the location of construction joints.
- If in the opinion of the Engineer, the drawings are inadequate or inaccurately prepared, revise and resubmit all shop drawings.

## 7.12.2 Products

### 7.12.2.1 Materials

- **Reinforcing Steel:** billet steel, Grade 400, deformed bars to CSA-G30.18, unless indicated otherwise. Weldable low alloy steel deformed bars to CSA-G30.18.
- **Tie Bars:** to CSA-G30.18 grade 300, billet-steel, deformed bars, uncoated; and also to ASTM D3963 for epoxy-coated.
- **Steel Dowels:** to CSA-G30.18, clean, straight, free from flattened or burred ends, uncoated and also to ASTM D3963 for epoxy coated.
- **ColdDrawn Steel Wire:** to CSA-G30.3M, uncoated; to ASTM D3963 for epoxy coated.
- **Welded Steel Wire Fabric:** to CSA-G30.5M, uncoated; to ASTM D3963 for epoxy coated.
- Chairs, bolsters, bar supports, spacers: adequate for strength and support of reinforcing and live loads during construction conditions.
- **Tie Wire:** Cold-drawn annealed steel to CSA-G30.3.
- **Epoxy Coating:** to ASTM A775/A775M.
- **Galvanizing:** to CSA-G164.
- **Plain Round Bars:** to CSA-G40.21.
- All other materials not specifically described but required for a complete and proper installation of concrete reinforcement, shall be as selected by the Contractor and be subject to the approval of the Engineer.
- Supplementary cementing materials and their use to CSA-A3000.

### 7.12.2.2 Fabrication

- Fabricate reinforcing steel in accordance with CSA-A23.1, ACI 315, unless otherwise stated.
- Obtain Engineer's approval for locations of reinforcement splices other than those shown on placing drawings.
- Upon approval of Engineer, weld reinforcement in accordance with CSA-W186.
- Ship bundles of bar reinforcement, clearly identified in accordance with bar bending details and lists.

- Protect epoxy and paint coated portions of bars with covering during transportation and handling.

### **7.12.3 Execution**

#### **7.12.3.1 Field Bending**

- Do not field bend or field weld reinforcement except where indicated or authorized by the Engineer.
- When field bending is authorized, bend without heat, applying a slow and steady pressure.
- Replace bars that develop cracks or splits.

#### **7.12.3.2 Placing Reinforcement**

- Place reinforcing steel as indicated on approved drawings and in accordance with CSA-A23.1.
- Place sufficient chairs, and supports to adequately maintain the position of the reinforcing steel during placement of concrete, to within tolerances specified in the referenced CSA/CAN guidelines. Use tie wire to prevent the moving or dislodging of reinforcing steel during placement of the concrete.
- Use plain round bars as slip dowels in concrete. Paint portion of dowel intended to move within hardened concrete with one coat of asphalt paint. When paint is dry, apply a thick even film of mineral lubricating grease.
- Prior to placing concrete, obtain the Engineer's approval of reinforcing material placement.
- Ensure cover to reinforcement is maintained during concrete pour.
- Reinforcing steel, anchor bolts, or other required inserts shall not be inserted into concrete during placement.

#### **7.12.3.3 Field Touch-up**

Touch up damaged and cut ends of epoxy coated or galvanized reinforcing steel with compatible finish to provide continuous coating.

## 7.13 SLABJACKING

### 7.13.1 General

#### 7.13.1.1 Content

This section includes the raising depressed or settled concrete boulevard walk back to grade. Slabjacking cannot be used to correct deficiencies in new construction before final acceptance.

#### 7.13.1.2 Related Sections

- Aggregate Section 2.1
- Concrete Sidewalk, Curb and Gutter, and Slabs Section 7.2

#### 7.13.1.3 Submittals

Submit a grout mix design to the Technical Services Section, Integrated Infrastructure Services, at least 14 days prior to initial use and when there is a change in material, source, or proportion.

#### 7.13.1.4 Quality Assurance

The quality assurance laboratory will take random samples of the grout and test for spread, shrinkage and compressive strength.

### 7.13.2 Products

#### 7.13.2.1 Materials

- **Grout Cement:** Type GU/GUL/GULb/HS/HSL/HSLb – cement conforming to CSA A3000
- **Grout Aggregate:** to Section 2.1 - Aggregate, Designation 5 Class 5.
- **Pozzolanic Material:** to CSA A3000 Supplementary Cementitious Material Type F
- **Water:** to CSA A23.1
- **Admixtures:** powdered bentonite or water reducer as required.
- **Material Sources:** All material shall be obtained from the same source or manufacturer. Submit a written request for change of source to the Engineer 10 days prior to proposed change. No change shall be made until approved by the Engineer.

### 7.13.2.2 Equipment

- **Grout Pump:** non-pulsing, positive displacement pump, with a pressure capacity of 350 to 1750 kPa at the discharge hose outlet, with a flow capacity of 5 m<sup>3</sup>/h minimum and equipped with a device for accurately measuring the volume of grout pumped.
- **Drilling Rig:** capable of drilling a 75 mm maximum diameter hole through the concrete slab.

### 7.13.2.3 Mixes

- The grout mix design shall meet the following criteria:
- **Cement Content:** minimum of 160 kg/m<sup>3</sup>.
- **Fly Ash:** minimum of 160 kg/m<sup>3</sup>.
- **Compressive Strength:** minimum of 0.7 MPa at 28 days.

## 7.13.3 Execution

### 7.13.3.1 Preparation

- **Utilities:** The Contractor is responsible for obtaining the locations of underground utilities, including but not limited to buried electrical lines, cables, telephone lines and water and drainage pipes.
- **Site Protection:** Provide hoarding or suitable protection around the work site for public safety and to minimize disruption to adjacent residences and businesses.
- **Equipment Support:** Ensure that site conditions can support equipment for drilling and grouting.
- **Air Temperature:** Work shall not proceed when the air temperature is less than 5°C.

### 7.13.3.2 Jacking

- Remove sheet asphalt or grout on previously repaired walk.
- Mark strategic locations for drill holes on the walk. Drill holes through the slab to a grouting depth of 50 mm to 300 mm as required.
- Sawcut the slab where required to free it from binding.
- Pump grout to fill all voids below the slab while lifting it to a controlled elevation.
- Ensure that lifting of the slab is done in small increments to prevent slab cracking or damage.



- After grouting, fill the drill holes with 25 MPa at 28 days concrete grout, having 10 mm maximum size aggregate.
- **Record Keeping:** For each location, record the volume of grout pumped below the slab and the slab elevations on 3 m grid points before and after grouting. Submit records to the Engineer upon completion of the work at each location.

#### **7.13.3.3 Field Quality Control**

- **Tolerances along Centreline of Walk:** 6mm maximum variation under a 3 m straightedge or taut string line parallel to centreline of the walk.
- **Tolerances between Sections of Walk:** 6mm maximum differential level at a construction joint between adjacent sections of walk.

#### **7.13.3.4 Correction of Deficiencies**

- Change the grout mix proportions and/or change the composition or source of the aggregate to correct deficiencies in the grout strength.
- Continue jacking and grouting until the tolerances in 7.13.3.3 are met.
- Repair cracks  $\geq 3$  mm in width caused by jacking, to the satisfaction of the Engineer.
- Remove broken or damaged slab and replace with new concrete walk to Section 7.2 - Concrete Sidewalk, Curb and Gutter, and Slabs.

#### **7.13.3.5 Cleanup**

- If the slab jacked walk crosses an alley, do not open the alley to vehicle traffic until the grout has cured for at least 24 hours.
- Remove all surplus material and debris from site.
- Remove hoarding, barricades and signs no longer needed.

## 8 MISCELLANEOUS

### 8.1 GABIONS

#### 8.1.1 General

##### 8.1.1.1 Content

This section includes the supply and installation of gabion baskets and rock fill.

##### 8.1.1.2 Related Sections

Grading Section 2.3

##### 8.1.1.3 Definitions

- **Gabion:** a galvanized steel wire mesh basket filled with rock or broken concrete, and forming part of a larger monolithic structure of several such baskets, used for erosion control or other purposes.
- **Selvedge:** the thicker perimeter and edge wires to which the wire mesh is securely tied to withstand stress from any direction.
- **Corner Wire:** the thicker reinforcing wire built into each corner of a gabion basket fabricated as a single unit.
- **Binding Wire:** wire used to tie together components forming a gabion basket and to tie together adjoining baskets.
- **Connecting Wire:** internal wire used to connect opposite walls inside a basket cell to resist bulging.
- **Diaphragm:** a wire mesh used to partition a gabion basket into equal-sized cells.

#### 8.1.2 Products

##### 8.1.2.1 Gabions

- **Wire:** made of steel, hot-dip galvanized at a zinc coating of 256 g/m<sup>2</sup> minimum, with a tensile strength of 410 MPa minimum, capable of elongation of 10% minimum, and of the following diameters (±2%):
  - **Wire for Mesh:** 2.95 mm
  - **Selvedge and Corner Wires:** 3.85 mm
  - **Binding and Connecting Wires:** 2.20 mm

- **Wire Mesh:** to be fabricated as follows:
  - Pre-galvanized wire woven in a double twist pattern with uniform hexagonal openings approximately 80 mm by 100 mm.
  - To be non-raveling, that is, to resist pulling apart at any twist or connection forming the mesh.
  - Perimeter edges of mesh to be securely selvedge, to ensure that joints formed by tying selvedges are as strong as the body of the mesh.
- **Gabion Basket:** to be constructed as follows:
  - To be of single unit construction, or with joints having strength and flexibility equal to that of the mesh.
  - For jointed construction, bases, sides, ends, lids, and diaphragms can be readily assembled at site into rectangular baskets of sizes detailed on drawings.
  - When length exceeds 1.5 times the horizontal width, diaphragms of same mesh as gabion wall shall be securely placed to divide the basket into equal cells of a length not exceeding the width.
- **Alternate Fasteners:** Galvanized steel wire fasteners may be used in lieu of binding wire for gabion basket assembly and fastening baskets to one another, subject to prior approval of the Engineer. Such fasteners shall conform to the following:
  - Wire Diameter and Coating: 3.05 mm ( $\pm 2\%$ ) with zinc coating of 256 g/m<sup>2</sup> minimum.
  - Wire Tensile Strength: 1 700 MPa minimum.
  - Pull Strength: Fastener to remain locked and closed while resisting a pulling force of 110 kg minimum for assembling basket components, and 410 kg minimum for binding adjoining baskets.

#### 8.1.2.2 Rock Fill

- Quality: Rock shall be clean, hard and durable, and may be broken rock, quarry rock, or broken concrete which will not disintegrate when exposed to water, wave action, wetting and drying, or freezing and thawing cycles.
- Sizes: Rock pieces shall range from 100 mm minimum dimension to 300 mm maximum dimension.

### 8.1.3 Execution

#### 8.1.3.1 Site Preparation

Perform excavation and grading for the gabion structure to the indicated lines and grades according to Section 2.3 – Grading. Remove and dispose of stumps, roots, and debris.

#### 8.1.3.2 Placing Gabions

- **Basket Assembly:** Assemble each gabion basket, if not of single unit fabrication, by tying the selvedge of components at the joints with binding wire.
- **Binding Method:** Throughout the length of selvedge, loop the binding wire tightly around every other mesh opening, alternating single and double loops. Alternatively, place specified fasteners locked tight against the selvedge or seam.
- **Use of Fasteners:** In lieu of binding wire, where permitted by the Engineer, install approved fasteners at a maximum spacing of 75 mm, using suitable manual pliers or a hand-held pneumatic gun with magazine feed. Wrap each fastener tight around the seam to prevent ravelling. The Engineer will withdraw permission to use fasteners if he finds them loose or ravelling.
- **Placing Baskets:** Place the initial level of empty baskets into position. Secure adjacent baskets together with binding wire along corners and contacting selvedge edges as described above under Binding Method.
- **Filter Fabric:** If specified in the contract Special Provisions, place geotextile fabric against the gabion wall and top in contact with surrounding ground. Lap the fabric at joints a minimum of 500 mm.
- **Initial Filling and Stretching:** Partially fill the first basket in a row with enough rock to provide weight. Then stretch up to 4 or 5 baskets in a row taut, to the proper alignment.
- **Succeeding Level of Gabions:** Secure each new basket to the top of a fully filled gabion with binding wire along the base perimeter. In each succeeding level of gabions, stagger vertical joints between baskets so that no vertical joint is directly in line with a vertical joint in the next lower level.

#### 8.1.3.3 Rock Filling

- **Exposed Face:** On the exposed faces of gabion baskets, place rock by hand with flattest surfaces bearing against the face mesh to produce a satisfactory alignment and appearance. Fill the rest of the gabions by hand or by mechanical means, taking care to minimize voids and bulges.

- **Lifts:** Fill each basket cell to a depth of 300 mm at a time.
- **Connecting Wires:** After each 300 mm lift, connect opposite walls of cell with 2 connecting wires in each direction on top of lift. Loop each wire around 2 adjoining mesh openings, pull hand tight and twist the ends secure to prevent loosening.
- **Staged Filling:** To prevent local deformation, fill a cluster of gabion baskets in stages so that no basket is filled more than 300 mm higher than the adjoining baskets.
- **Securing Lids:** When a gabion basket is filled full, bend over the lid by hand and secure with binding wire to the basket rim and diaphragms in the same manner as 8.1.3.2 Binding Method.
- **Backfill and Cover:** Backfill gaps between the gabions and surrounding ground, and place clay cover as indicated on the drawings or as directed by the Engineer.

#### **8.1.3.4 Workmanship**

- No wire ends shall be left projecting outside exposed surfaces.
- All exposed geotextile fabric shall be trimmed flush with the cover material.
- There shall be no voids left between adjacent baskets. The use of binding wire or wire mesh to correct voids is not permitted.
- Joints between gabion baskets shall be as strong as the wire mesh, thereby making a monolithic structure.
- The installed gabions shall have proper alignment and a neat, compact, square appearance.

## 8.2 HEAVY ROCK RIP RAP

### 8.2.1 General

#### 8.2.1.1 Content

This section includes the supply, delivery, and installation of heavy rock riprap. This work shall include all necessary trimming, excavation, and fill required to satisfactorily place the rock riprap, such as:

- Excavation, trimming and shaping head slope
- Excavation at head slope toe, and for rock apron
- Excavation for rock in stream bank transition zone
- Supply and placing of geotextile filter fabric
- Supply and placing of gravel or granular bedding material

#### 8.2.1.2 Related Section:

- Section 2.3 – Grading

### 8.2.2 Products

#### 8.2.2.1 Rock Material

- **Quality:** Rock shall be clean, hard, durable and angular in shape, and may be broken rock, quarry rock, or broken concrete which will not disintegrate when exposed to water, wave action, wetting and drying, or freezing and thawing cycles, free from overburden, spoil, shale or shale seams and organic material, and shall meet the gradation requirements for the class specified. No sandstone will be permitted for all classes. The minimum dimension of any single rock shall be not less than one-third of its maximum dimension. The minimum acceptable unit weight if the rock is 2.5 tonnes/m<sup>3</sup>.
- **Sizes:** The material provided for each class specified shall have a gradation that conforms to Table 8.2.1:

**Table 8.2.1: Gradation Requirements**

Class		1M	1	2	3
Nominal Mass (kg)		7	40	200	700
Nominal Diameter (mm)		175	300	500	800
None Greater than:	Kg	40	130	700	1800
	or mm	300	450	800	1100
20% to 50%	Kg	10	70	300	1100
	or mm	200	350	600	900
50% to 80%	Kg	7	40	200	700
	or mm	175	300	500	800
100% greater than	Kg	3	10	40	200
	or mm	125	300	300	50

\*Percentages quoted are by mass.

\*\*Sizes Quoted are equivalent spherical diameters, and are for guidance only.

- Rip Rap shall meet the following minimum requirements for specific gravity, absorption and durability:

**Table 8.2.2: Rip Rap Minimum Requirements**

Method of Test	Requirements
California Department of Transportation Method of Test for Specific Gravity and Absorption of Coarse Aggregate ( California Test 206)	Maximum Specific Gravity = 2.60
	Maximum Absorption = 2.0%
California Department of Transportation Method of test for Durability Index (California Test 229)	Minimum Durability Index = 52
	Durability Index may be less than 52 if DAR*>23

\* Durability Absorption Ratio (Dar) = Durability Index/ (absorption% = 1%)

### 8.2.2.2 Sandbag Rip-Rap

Sandbag riprap is a “man-made” riprap consisting of burlap bags filled with fresh concrete and placed in a dense layer before the concrete has set.

### 8.2.2.3 Geotextile Filter Fabric

- Where geotextile filter fabric is specified, the slope shall be graded to provide a smooth, uniform surface. All stumps, large rock, brush or other debris that could damage the fabric shall be removed. All holes and depressions shall be filled so that the fabric does not bridge them. Loose or unstable soils shall be replaced.
- Non-woven geotextile filter fabric shall be used under all riprap in accordance with the following table of minimum average roll value properties (MARVs) for each specific Class of riprap:

**Table 8.2.3: Non-Woven Geotextile Filter Fabric Properties**

Non-Woven Geotextile Filter Fabric		
Specifications and Physical Properties		
	Class 1M, 1 and 2	Class 3
Grab strength	650 N	875 N
Elongation (Failure)	50%	50%
Puncture Strength	275 N	550 N
Burst Strength	2.1 MPa	2.7 MPa
Trapezoidal Tear	250 N	350 N
Minimum Fabric Lap to be 300 mm		

\*The non-woven geotextile filter fabric shall meet the specifications and physical properties as listed above.

- **Placement:**
  - The fabric shall be laid parallel to the slope direction. It shall be placed in a loose fashion; however folds and wrinkles shall be avoided. Adjacent strips of fabric shall be overlapped a minimum of 300 mm, except where placed underwater, the



minimum lap width shall be 1 m. Overlaps shall be pinned using 6 mm diameter steel pins fitted with washers and spaced at 1 m intervals along the overlaps.

- The top edge of the filter fabric shall be anchored by digging a 300 mm deep trench, inserting the top edge of the fabric and backfilling with compacted soil.
- Care shall be taken to prevent puncturing or tearing the geotextile. Any damage shall be repaired by use of patches that extend at least 1 m beyond the perimeter of the tear or puncture.
- The fabric shall be covered by rock riprap within sufficient time so that ultraviolet damage does not occur; in no case shall this time exceed 7 days for ultraviolet material and 14 days for ultraviolet protected and low ultraviolet susceptible polymer geotextiles.
- Riprap placement shall commence at the base of the blanket area and proceed up the slope. The height of drop of riprap shall be limited to 1.0 m or less, and the riprap shall not be allowed to roll down the slope. Heavy equipment will not be permitted to operate directly on the geotextile

### **8.2.3 Execution**

#### **8.2.3.1 Site Preparation**

Perform excavation and grading for the Rip Rap to the indicated lines and grades according to Section 2.3 – Grading. Remove and dispose of stumps, roots, and debris.

#### **8.2.3.2 Placing of Rock**

The rock shall be handled, dumped or placed into position to conform to the specified gradation and to the cross section shown on the drawings. The finished surface shall be reasonably uniform, free from bumps or depressions, and with no excessively large cavities below or individual stones projecting above the general surface.

#### **Placing of Sandbag Riprap**

Sandbag riprap is to be placed on a surface that is trimmed and dressed to the lines and grades shown on the plans. A trench may be required at the base of the slope to receive the bags. Sandbag riprap is used mainly as drain trough terminal protection as detailed in the applicable specification.

- The bags are to be filled approximately two-thirds full with concrete with the tops folded closed and they are to be placed immediately when the concrete is fresh.
- The bags are to be the prepared surface with the ends in the same direction in a manner that results in a shingled effect.

- The upstream end of any bag must be under the end of the bag placed next to it.
- The bags are to be placed from the downstream edge towards the upstream edge, and from the bottom row towards the top.
- The folded ends of the bags must be placed underneath.
- The bags are to be rammed and packed against each other to leave a uniform surface, with the layer not less than 130 mm thick.

**8.2.3.4 Inspection of Rock**

- Control of gradation will be by visual inspection. The Contractor shall provide a minimum of two samples of rock, of the minimum sample size specified below. These samples shall be proven to acceptably conform to the required gradation by direct weighing of all the individual pieces with suitable scales; the mass of each piece in the sample shall be painted on the piece. These samples, located as required by the Consultant at the construction site and at the source or quarry site, may be incorporated in the finished riprap when they are no longer required for reference purposes. The samples shall be used for frequent reference in judging the gradation of the riprap being loaded at the source and placed at the site. The minimum sample size in area shall be as follows:

<u>Class</u>	<u>Maximum Sample Size</u>
1M	1 m x 1 m
1	2 m x 2 m
2	3 m x 3 m
3	4 m x 4 m

- The Contractor shall provide, at no additional cost to the Department, whatever facilities are required to assist the Consultant in checking gradation and measuring riprap in place.
- If, during the delivery of the material to the site, a particular load is found to be made up of pieces predominantly one size, or to be lacking in pieces of one size, it shall be dumped in a suitable location outside the area to be protected. Additional material as required to make up the deficient sizes shall be added to this load such that the combination can then be placed to ensure uniformity.

## 8.3 BOX BEAM GUARD RAIL

### 8.3.1 General

#### 8.3.1.1 Content

This section includes the supply and installation of box beam guard rail.

#### 8.3.1.2 Related Sections

- Cement Concrete Section 7.1
- Hot-Mix Asphalt Concrete Section 6.1

### 8.3.2 Products

#### 8.3.2.1 Materials

- Box Beam Rail: steel tubing to ASTM A501, size as specified on drawings.
- Posts, Plates and Shapes: of steel conforming to ASTM A36M.
- Fastenings: steel bolts, U-bolts, studs, nuts and washers conforming to ASTM A325M.
- Zinc Coating: all steel products to be hot-galvanized according to ASTM A123.
- Hot-Mix Asphalt: appropriate mix to Section 6.1 - Hot-Mix Asphalt Concrete.
- Concrete: to Section 7.1 - Cement Concrete, class D.

#### 8.3.2.2 Fabrication

- Welding: to CSAW47.1 and CSAW59M.
- Edges cut by a welding torch shall be ground to a smooth finish.
- Galvanize steel products after fabrication and welding.

### 8.3.3 Execution

#### 8.3.3.1 Post Setting

- Without Asphalt or Concrete Base: Drive post into the ground.
- With Asphalt  $\leq 75$  mm and without Concrete Base: Drive post through the existing asphalt pavement. Patch with hot-mix asphalt concrete tamped around the post flush with existing surface.

- With Asphalt >75 mm, or with Concrete Base: Drill a 300 mm diameter hole, or sawcut a 300 mm square hole, through the existing asphalt pavement or through the existing concrete base. Drive the post into the hole. Tamp clay or gravel into the remaining void around the post and cap with 50 mm of hot-mix asphalt concrete tamped flush with existing surface.
- Each post shall have at least half of its length set below ground or pavement surface elevation.

#### **8.3.3.2 Field Cutting**

Steel material may be cut with a saw or with a welding torch. Grind smooth and round all rough and sharp edges.

#### **8.3.3.3 Field Welding**

Perform field welding if permitted by the Engineer. Remove slag and spatter and smooth surfaces.

#### **8.3.3.4 Touch Up**

Apply a coat of "Galvacon" to cut, welded and other surfaces where the galvanizing has been damaged.

#### **8.3.3.5 Concrete Anchor**

- **Precast Anchor:** Bury the anchor in a hole backfilled with clay compacted to a minimum 98% of maximum standard Proctor density according to ASTM D698 Method A.
- **Cast-in-Place Anchor:** Dig a hole to the specified anchor dimensions and fill with concrete. Trowel exposed surface to a smooth finish.
- **Surface Restoration:** Restore the surface around anchors with tamped hot-mix asphalt or with concrete to match the existing surface.

#### **8.3.3.6 Field Quality Control**

- **Elevation Tolerances:** 13 mm maximum variation from designated grade of top of guard rail.
- **Alignment Tolerances:** 50 mm in 10 m maximum deviation from designated alignment of guard rail.
- **Post Tolerances:** 13 mm maximum deviation from plumb position of post.
- **Deficiencies:** Guard rail not meeting the above tolerances shall be removed and replaced.

## 8.4 CONCRETE BARRIER

### 8.4.1 General

#### 8.4.1.1 Content

This section includes the construction of median or roadside Cement concrete barrier by slipforming, by casting in place or with precast units.

#### 8.4.1.2 Related Sections

- Cement Concrete Section 7.1
- Concrete for Roadways Section 7.3
- Concrete Forms and Accessories Section 7.10
- Reinforcing Steel Section 7.12

#### 8.4.1.3 Submittals

Submit a concrete mix design for precast barrier units or precast mini barrier unit to the Technical Services Section, Integrated Infrastructure Services at least 14 days prior to delivery.

#### 8.4.1.4 Quality Assurance

Slump, air content, airvoid examination, strength tests and acceptance criteria: to Section 7.1 - Cement Concrete

### 8.4.2 Products

#### 8.4.2.1 Materials

- Slipform or Cast-In-Place Concrete: Class C, to Section 7.1 - Cement Concrete and Section 7.3 - Concrete for Roadways.
- Reinforcement and Tie Bars for Cast-In-Place Units: epoxycoated, deformed, to Section 7.12 - Reinforcing Steel.
- Preformed joint filler and curing compound for Slipformed or Cast-In-Place Units: to Section 7.3 - Concrete for Roadways.
- **Precast Barrier Unit:** manufactured to CSA A23.4 and to the following requirements:
  - **Dimensions:** 3 m long and crosssection as detailed on drawings, with tolerances to CSA A23.4.

- **Concrete:** 30 MPa minimum compressive strength at 28 days, with 5.5% to 8% entrained air.
  - **Reinforcement:** epoxy coated, deformed, to Section 03210 - Reinforcing Steel.
  - End connection: 2 vertical tongue and groove keys, dimensioned to a tolerance of  $\pm 5$  mm for a tight fit.
  - **Surface finish:** steel form finish, not rubbed, smooth, dense, un-pitted and free from honeycomb.
  - **Curing methods:** accelerated steam curing, moist curing, or membrane curing.
- **Precast Mini-barrier Unit:** manufactured to CSA A23.4 and to following requirements:
    - **Dimensions:** 3 m long and crosssection as detailed on drawings, with tolerances to CSA A23.4.
    - **Concrete:** 30 MPa minimum compressive strength at 28 days, with 5.5% to 8% entrained air. Submit concrete mix design to the Technical Services Section at least 14 days prior to delivery.
    - **Surface finish:** steel form finish, not rubbed, smooth, dense, un-pitted and free from honeycomb.
    - **Curing methods:** accelerated steam curing, moist curing, or membrane curing.

#### 8.4.2.2 Equipment

Slipform Machine: to Section 7.10 – Concrete Forms and Accessories.

### 8.4.3 Execution

#### 8.4.3.1 Preparation

- Construct base of barrier as detailed on drawings.
- Light pole bases and conduits shall be in place prior to slipforming or casting in place.
- Have Engineer inspect base before slipforming or installing precast units.

#### 8.4.3.2 Slipform Construction

- Prior to slipforming, cast concrete in place for segments where slipforming is not practical.
- Slipform concrete to Section 7.10 – Concrete Forms and Accessories.

- Slipform over top of pole bases. Once machine is past, immediately remove concrete over pole base and clean thoroughly.
- Finish: Slipformed surfaces shall be smooth, dense, un-pitted and free of honeycombing. Perform the minimum amount of work required to correct minor irregularities.
- **Joints:**
  - **CrackControl Joints:** Saw cut or tool vertically 12 mm wide by 50 mm deep at maximum 6 m spacing to Section 7.1 - Cement Concrete. Match with joints of curb, gutter, or pavement.
  - **Isolation and Construction Joints:** vertical, to Section 7.1 - Cement Concrete.
- **Protection and Curing:** to Section 7.1 - Cement Concrete.

#### **8.4.3.3 Cast-In-Place Construction**

- Construct to Section 7.1 - Cement Concrete and Section 7.3 - Concrete for Roadways as supplemented below.
- **Finish:** Formed surfaces shall be smooth, dense and free of honeycombing.
- **Joints:** Saw cut or form crackcontrol joints to Section 7.3 - Concrete for Roadways. Place isolation and construction joints

#### **8.4.3.4 Precast Construction**

Place precast units true to alignment.

Make tight tongue and groove connection between units.

#### **8.4.3.5 Precast Minibarrier**

Place minibarrier units to designated alignment.

Make proper connections between units.

#### **8.4.3.6 Quality Control**

- **Slipform and Cast-In-Place Surface Tolerances:** 6 mm maximum variation under a 3 m straightedge.
- **Slipform and Cast-In-Place Barrier Top Elevation Tolerances:**  $\pm 6$  mm maximum variation from designated elevation.

- **Slipform and Cast-In-Place Barrier Top Alignment Tolerances:**  $\pm 10$  mm maximum variation from designated alignment in any 20 m length.
- **Slipform and Cast-In-Place Barrier Shape Tolerances:**  $\pm 10$  mm maximum variation from indicated crosssectional dimensions.
- In slipforming, continually check tolerances and immediately correct excessive variations while concrete is still plastic.
- The Engineer will suspend the Contractor's operations if poor workmanship persists or is not corrected.
- **Precast Barrier Top Elevation Tolerances:**  $\pm 10$  mm maximum variation from designated grade elevations.
- **Precast Barrier Top Alignment Tolerances:**  $\pm 10$  mm maximum variation from designated alignment in any 20 m length.
- **Tolerance for Lipping between Adjacent Precast Units:** 10 mm maximum.

#### **8.4.3.7 Protection of Finished Work**

- Protect finished work from damage. Repair if damaged.
- Leave completed work clean and free of debris and remove signs and barricades no longer needed.





# COMPLETE STREETS STANDARD DRAWINGS

*City of Edmonton*





## Standard Drawing Index

<b>SECTION 1000 - UTILITY CUT RESTORATION</b>	<b>497</b>
1000 PAVEMENT RESTORATION AFTER UTILITY CUT	498
1010 ROAD SURFACE RESTORATION AFTER UTILITY CUT	499
1020 TRANSVERSE CUT RESTORATION ARTERIAL ROAD	500
1021 TRANSVERSE CUT RESTORATION 14.5m COLLECTOR ROAD	501
1022 TRANSVERSE CUT RESTORATION 11.5m COLLECTOR ROAD	502
1023 TRANSVERSE CUT RESTORATION LOCAL INDUSTRIAL ROAD	503
1024 TRANSVERSE CUT RESTORATION LOCAL RESIDENTIAL ROAD	504
1025 TRANSVERSE CUT RESTORATION ALLEYS	505
1030 CURB AND GUTTER / MONOWALK REPLACEMENT SAWCUT DETAILS	506
<b>SECTION 2000 - CROSS-SECTIONS</b>	<b>507</b>
2000 TYPICAL BERM SECTION	508
2020 STAGED ARTERIAL GRADING REQUIREMENTS	509
2030 RESIDENTIAL SERVICE ROAD	510
2031 INDUSTRIAL SERVICE ROAD	511
2040 4.00m RESIDENTIAL ALLEY	512
2041 6.00m COMMERCIAL ALLEY	513
2042 RESIDENTIAL REVERSE HOUSING ALLEY - 7.50m ROW	514
2043 REVERSE HOUSING ALLEY WITH PARKING - 9.50m ROW	515
2050 9.00m RURAL LOCAL / COLLECTOR ROADWAY	516
2060 TEMPORARY ACCESS / DETOUR ROAD	517
2120 8.00m URBAN LOCAL RESIDENTIAL (MONOWALK BOTH SIDES) - 16.00m ROW	518

2125	8.00m STREET ORIENTED RESIDENTIAL LOCAL (ON BIKE NETWORK / NOT ON BIKE NETWORK) - 16.00m ROW	519
2200	9.00m URBAN LOCAL RESIDENTIAL (MONOWALK) - 17.00m ROW	520
2210	9.00m STREET ORIENTED RESIDENTIAL LOCAL (ON BIKE NETWORK / NOT ON BIKE NETWORK) - 17.00m ROW	521
2300	11.50m INDUSTRIAL LOCAL (MONOWALK) - 20.00m ROW	522
2310	11.50m INDUSTRIAL LOCAL (BOULEVARD WALK) - 20.00 ROW	523
2320	11.50m STREET ORIENTED RESIDENTIAL COLLECTOR (NOT ON BIKE NETWORK) - 20.00m ROW	524
2321	9.30m COLLECTOR (NOT ON BIKE NETWORK) - 18.00m ROW	525
2322	10.70m NON-STREET ORIENTED RESIDENTIAL COLLECTOR (ON BIKE NETWORK) - 19.00m ROW	526
2323	11.30m NON-STREET ORIENTED RESIDENTIAL OR COMMERCIAL/MIXED USE COLLECTOR (ON BIKE NETWORK) - 19.60m ROW	527
2324	13.75m STREET ORIENTED RESIDENTIAL COLLECTOR (ON BIKE NETWORK) - 22.0m ROW	528
2325	9.30m NON-STREET ORIENTED RESIDENTIAL OR COMMERCIAL / MIXED USE COLLECTOR (ON BIKE NETWORK) - 22.0m ROW	529
2326	12.00m STREET ORIENTED COMMERCIAL/MIXED USE COLLECTOR (NOT ON BIKE NETWORK) - 22.00m ROW	530
2327	11.50m STREET ORIENTED RESIDENTIAL COLLECTOR (ON BIKE NETWORK) - 22.0m ROW	531
2328	11.50m SCHOOL SITE COLLECTOR (NOT ON BIKE NETWORK) - 20.0m ROW	532
2341	16.30m STREET ORIENTED RESIDENTIAL COLLECTOR (ON BIKE NETWORK) - 24.00m ROW	533
2342	16.80m STREET ORIENTED COMMERCIAL MIXED-USE COLLECTOR (ON BIKE NETWORK) - 26.60m ROW	534
2410	13.70m URBAN COLLECTOR (BOULEVARD WALK) - 23.80m ROW	535
2411	13.20m INDUSTRIAL COLLECTOR (SHARED USE PATH) - 24.00m ROW	536
2420	11.10m HYBRID INDUSTRIAL COLLECTOR (BOULEVARD WALK) - 30.55m ROW	537
2421	9.50m HYBRID INDUSTRIAL LOCAL (BOULEVARD WALK) - 27.50m ROW	538
2430	9.00m RURAL INDUSTRIAL COLLECTOR - 42.90m ROW	539
2431	9.00m RURAL INDUSTRIAL LOCAL - 38.60m ROW	540
2500	5 LANE INDUSTRIAL URBAN UNDIVIDED ARTERIAL - 37.00m ROW	541
2510	FOUR LANE NON-STREET ORIENTED RESIDENTIAL DIVIDED ARTERIAL - 37.00m ROW - B	542
2510A	FOUR LANE NON-STREET ORIENTED RESIDENTIAL DIVIDED ARTERIAL - 37.00m ROW - B	543
2515	FOUR LANE STREET ORIENTED RESIDENTIAL DIVIDED ARTERIAL - 40.00m ROW	544

2520	6 LANE URBAN DIVIDED ARTERIAL - 44.00m ROW	545
2530	RURAL FIVE LANE INDUSTRIAL ARTERIAL (SHARED USE PATH) - 57.40m ROW	546
2600	UTILITIES LOCATION PLAN WALKWAYS	547
2720	SLOPE REGULATION RESIDENTIAL PRIVATE DRIVEWAY/PARKADE RAMP MONOWALK	548
2730	SLOPE REGULATIONS RESIDENTIAL PRIVATE DRIVEWAY/PARKADE RAMP BOULEVARD WALK	549
<b>SECTION 3000 - DESIGN DETAILS</b>		550
3000	INDUSTRIAL SERVICE ROAD "BULB" ENTRANCE	551
3010	MAJOR COMMERCIAL ACCESS TYPICAL CURB RETURN FORMAT	552
3020	RURAL LOCAL ACCESS	553
3030	ALLEY WIDENING IN LIEU OF 3.00m x 3.00m CORNER CUT-OFF	554
3040	PUBLIC ALLEY CUL-DE-SAC AND CORNER CUTS	555
3100	RIGHT TURN STANDARD ARTERIAL TO ARTERIAL CHANNELIZED HIGH ENTRY ANGLE (YIELD CONDITION)	556
3110	RIGHT TURN STANDARD ARTERIAL TO ARTERIAL CHANNELIZED LOW EXIT ANGLE (FREE FLOW)	557
3120	RIGHT TURN STANDARD ARTERIAL TO ARTERIAL UNCHANNELIZED SIMPLE CURVE (STOP CONDITION)	558
3130	RIGHT TURN WITH MOUNTABLE CURB	559
3200	RIGHT TURN BAY STANDARD ARTERIAL TO COLLECTOR	560
3210	RIGHT TURN BAY STANDARD ARTERIAL TO ARTERIAL	561
3300	LEFT TURN BAY STANDARD NARROW MEDIAN	562
3310	LEFT TURN BAY STANDARD WIDE MEDIAN	563
3320	LEFT TURN STANDARD CHANNELIZED SLOT	564
3350	RIGHT AND LEFT TURN BAY STANDARD CURVED MAIN LINE	565
3400	ISLAND LAYOUT FOR INTRODUCTION OF CHANNELIZATION	566
3500	RESIDENTIAL CUL-DE-SAC (WITHOUT ISLAND)	567
3510	RESIDENTIAL CUL-DE-SAC (CIRCULAR ISLAND)	568
3520	RESIDENTIAL CUL-DE-SAC (CIRCULAR OFFSET ISLAND)	569
3530	RESIDENTIAL CUL-DE-SAC (CIRCULAR ISLAND)	570
3540	SIDEWALK REQUIREMENTS CUL-DE-SAC	571
3700	NEIGHBORHOOD TRAFFIC CIRCLE 9m URBAN LOCAL x 9m URBAN LOCAL	572

3710	MINI ROUNDABOUT 11.5m URBAN COLLECTOR x 11.5m URBAN COLLECTOR WITH SHARED-USE PATH AND ON-STREET BIKE LANE	573
3720	MULTILANE ROUNDABOUT 13.9m URBAN COLLECTOR x 13.9m URBAN COLLECTOR	574
3800	RAISED INTERSECTION CROSSING - ASPHALT	575
3805	RAISED INTERSECTION CROSSING - CONCRETE	576
3810	CONCRETE DETAILS - RAISED CROSSING	577
3815	RAISED INTERSECTION - ASPHALT	578
3830	RAISED MID BLOCK CROSSING - ASPHALT	579
3835	RAISED MID BLOCK CROSSING - CONCRETE	580
3840	CONTINUOUS CROSSING	581
3845	CONTINUOUS CROSSING ISOMETRIC DETAIL	582
3900	BOULEVARD SIDEWALK TRANSITION AT TRANSFORMER	583
<b>SECTION 4000 - TRANSIT DETAILS</b>		584
4000	LOCATION OF BUS STOP (UNCHANNELIZED INTERSECTION)	585
4010	LOCATION OF BUS STOP (CHANNELIZED INTERSECTION)	586
4100	BUS STOP AND AMENITIES PAD MONOWALK	587
4110	BUS STOP AND AMENITIES PAD BOULEVARD WALK	588
4200	BUS STOP AND AMENITIES PAD RURAL ROADWAY	589
4250	CLASS 'A' CONCRETE BUS STOP PAD (RETROFIT)	590
4300	TRANSIT TURNAROUND (OFFSET)	591
4400	SAWTOOTH TRANSIT BAY TRANSIT TERMINAL SITE	592
<b>SECTION 5000 - CONSTRUCTION DETAILS</b>		593
5000	150mm CURB WITH 250mm GUTTER	594
5001	150mm CURB WITH REVERSE 250mm GUTTER	595
5010	150mm CURB AND 250mm GUTTER WITH MONO CONCRETE HEADER	596
5011	150mm CURB AND 250mm REVERSE GUTTER WITH MONO CONCRETE HEADER	597
5020	STRAIGHT FACE CONCRETE CURBLINE WALK/BUS STOP (RETROFIT)	598
5021	ROLLED FACE CURBLINE WALK (RETROFIT)	599
5022	150mm CURB AND 500mm GUTTER (RETROFIT)	600
5023	125mm SEMI-MOUNTABLE CURB AND 250mm GUTTER	601

5024	80mm ROLLED MOUNTABLE FACE CURB AND 250mm GUTTER	602
5030	500mm/1000mm CONCRETE V-GUTTERS	603
5040	CONCRETE BARRIER CURB	604
5051	TEMPORARY SLAB-ON CONCRETE CURB	605
5052	TEMPORARY SLAB-ON ASPHALT CURB	606
5060	DEPRESSED CURB AND GUTTER FOR CATCHBASIN	607
5061	CATCHBASIN TREATMENT 50mm OVERLAY OF GUTTER	608
5070	LAWN MOWER ACCESS TO MEDIAN	609
5100	MONOLITHIC WALK WITH 150mm CURB AND 250mm GUTTER	610
5110	MONOLITHIC WALK WITH 150mm CURB AND 500mm GUTTER (RETROFIT)	611
5120	ROLLED FACE MONOLITHIC WALK AND GUTTER	612
5130	EMERGENCY ACCESS ROAD CONCRETE	613
5140	CONCRETE WALKWAY - 1.80m	614
5150	CONCRETE WALKWAY - GREATER THAN 1.80m	615
5160	SHARED USE PATH	616
5165	TOP OF BANK TRAIL	617
5170	GRANULAR WALKWAY	618
5180	SIDEWALK CONSTRUCTION AT TREE OPENING	619
5200	WOODEN WALK	620
5201	WOODEN STAIRS AND SUPPORT STRUCTURE	621
5205	WOODEN NOISE ATTENUATION FENCE	622
5210	PAVING BRICK SIDEWALK CONSTRUCTION	623
5215	PAVING BRICK CROSSWALK CONSTRUCTION	624
5300	ALLEY CROSSING BOULEVARD WALK AND APRONS	625
5310	ALLEY CROSSING MONOWALK AND APRONS	626
5320	PRIVATE CROSSING SEPARATE WALK AND APRONS	627
5330	PRIVATE CROSSING MONOWALK AND APRONS	628
5340	PRIVATE CROSSING MONOWALK (RETROFIT)	629
5400	COMMERCIAL CROSSING BOULEVARD WALK AND APRONS (BOULEVARD > 1.50m)	630
5410	COMMERCIAL CROSSING MONOWALK AND BOULEVARD WALK (BOULEVARD < 1.50m)	631

5500	CURB RAMP LOCATIONS	632
5510	CURB RAMP	633
5520	TACTILE WALKING SURFACE INDICATOR (TWSI) LAYOUT FOR SEPARATE WALK	634
5521	TACTILE WARNING SURFACE INDICATOR (TWSI) LAYOUT FOR WALK	635
5522	TACTILE WALKING SURFACE INDICATOR (TWSI) LAYOUT FOR MID-BLOCK CROSSING	636
5523	TACTILE WALKING SURFACE INDICATOR (TWSI) ORIENTATION FOR OFFSET INTERSECTIONS	637
5524	TACTILE WALKING SURFACE INDICATOR (TWSI) MEDIAN DETAIL	638
5530	TYPE A RAMP TWSI OPTION 1	639
5531	TYPE A RAMP TWSI OPTION 2	640
5600	MID-BLOCK BIKEWAY SLIP RAMP	641
5610	CENTRE MEDIAN END TREATMENT	642
5620	WIDE MEDIAN END TREATMENT	643
5630	CENTER MEDIAN REHABILITATION	644
5700	MULTI-PARTY UTILITIES TRENCHING	645
<b>SECTION 6000/7000 - MISCELLANEOUS</b>		646
6010	SLIPFORMED CONCRETE BARRIER 5.50m MEDIAN	647
6020	CONCRETE BARRIER ON PAVED MEDIAN	648
6030	END TRANSITION CONCRETE BARRIER	649
6050	LIFT OUT FOR CONCRETE BARRIER	650
6060	830mm CONCRETE SLIP-FORMED PARAPET WITH 1.00m SWALE	651
6085	HANDRAIL DETAILS	652
6090	STANDARD TAPER AT BRIDGE PIERS CONCRETE BARRIER	653
6100	PRE-CAST CONCRETE MINI-BARRIER	654
6101	END TRANSITION PRE-CAST CONCRETE MINI-BARRIER	655
6200	TYPICAL BOLLARD LAYOUT AND INSTALLATION FOR 1.80m CONCRETE WALKWAYS	656
6210	TYPICAL BOLLARD LAYOUT AND INSTALLATION FOR 3.00m SHARED-USE PATH	657
6220	TYPICAL BOLLARD WITH GALVANIZED STEEL W-SECTION	658
6230	TYPICAL BOLLARD LAYOUT FOR 3.00m ASPHALT SHARED-USE PATH WITHIN PIPELINE/POWER ROW	659
6240	EMERGENCY KNOCK-DOWN POST (RETROFIT)	660

6250	T-BOLLARD IN EMERGENCY ACCESS	661
6251	T-BOLLARD ASSEMBLY DETAIL	662
6300	ASPHALT SPEED HUMP	663
6500	COST SHARE PROJECT SIGN	664
6510	AUXILIARY PROJECT SIGN	665
6520	ARTERIAL ROAD PROJECT SIGN DEVELOPER-BUILT PROJECTS	666
6525	BRIDGE/CULVERT STANDARD IDENTIFICATION PLAQUES AND BENCHMARK TABLETS	667
6530	TYPICAL A-FRAME SIGN	668
6600	MANHOLE INSTALLATION FOR SURVEY CONTROL MARKERS DEPTHS BETWEEN 0.20m - 0.60m	669
7976	CATCH BASINS IN WALKWAY RIGHT-OF-WAY	670
7980	BACKFILL DETAIL OF MANHOLE AND VALVE RAISED TO GRADE	671
7981	BACKFILL DETAIL OF MANHOLE AND VALVE RAISED TO GRADE (FILLCRETE OPTION)	672





## Standard Drawings

### SECTION 1000 – Utility Cut Restoration

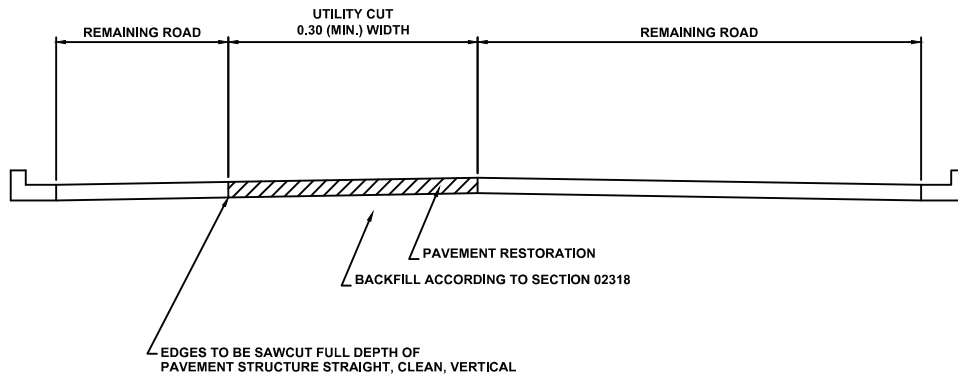
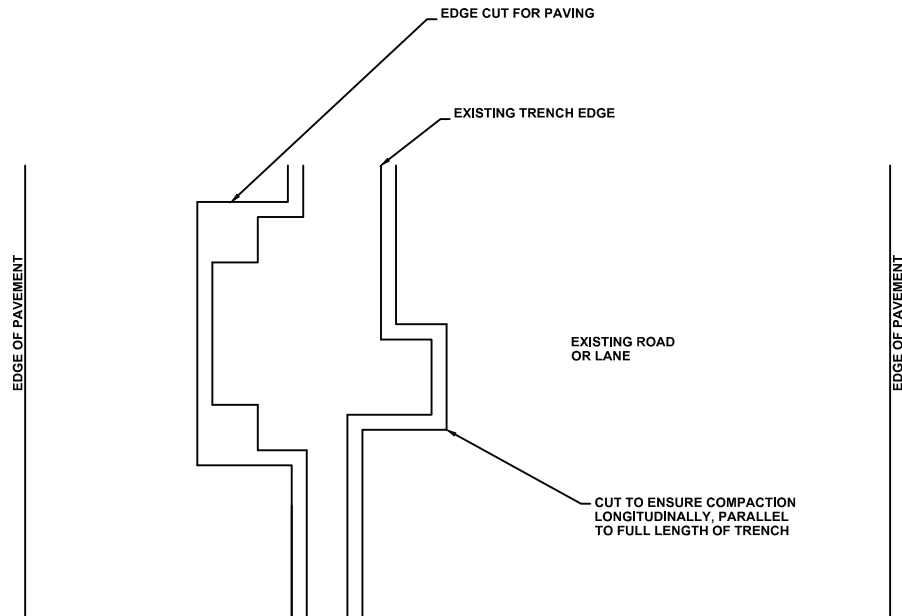

NOTE:

- 1. REMOVE AND REPLACE PAVEMENT STRUCTURE TO EDGE OF PAVEMENT (TO LIP OF GUTTER) WHEN WIDTH OF REMAINING ROAD < 1.50m.
- 2. REFER TO CONSTRUCTION SPECIFICATIONS SECTION 3.2 - UTILITY CUT RESTORATION.

**ALL DIMENSIONS  
IN METRES UNLESS  
OTHERWISE NOTED**



STANDARD DRAWING

## PAVEMENT RESTORATION AFTER UTILITY CUT

DATE APPROVED: **2018**

SCALE: **N.T.S.**

DRAWN BY: **KSYC**

CHECKED BY: **JN**

APPROVED: *M.A.R.*

DRAWING NUMBER: **1000**

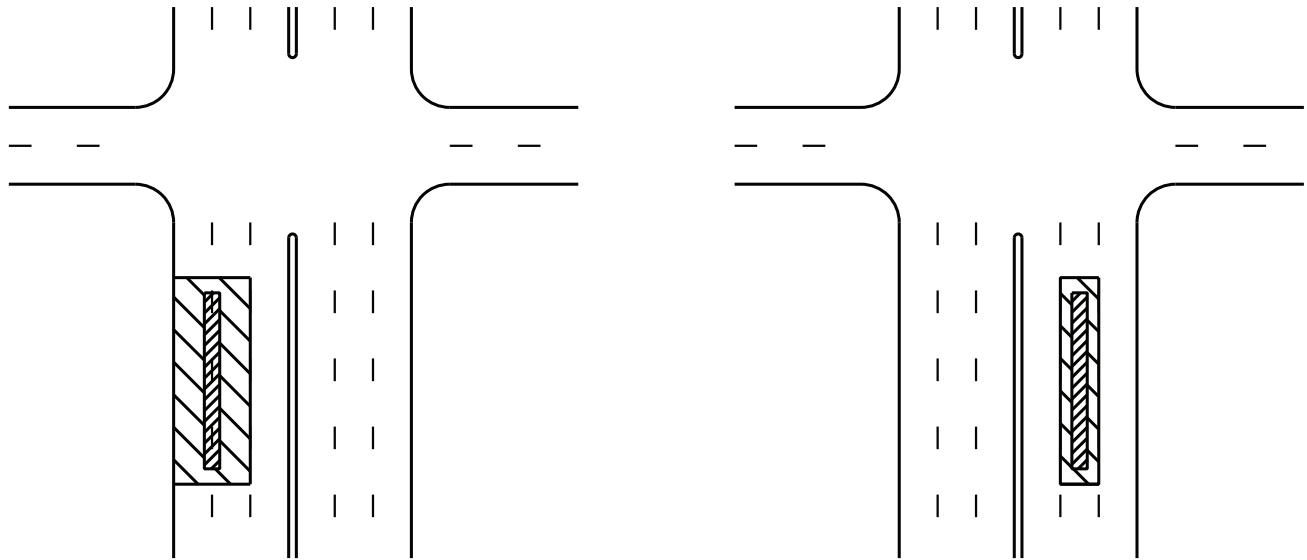

ROAD SURFACE WITH LANE MARKINGS

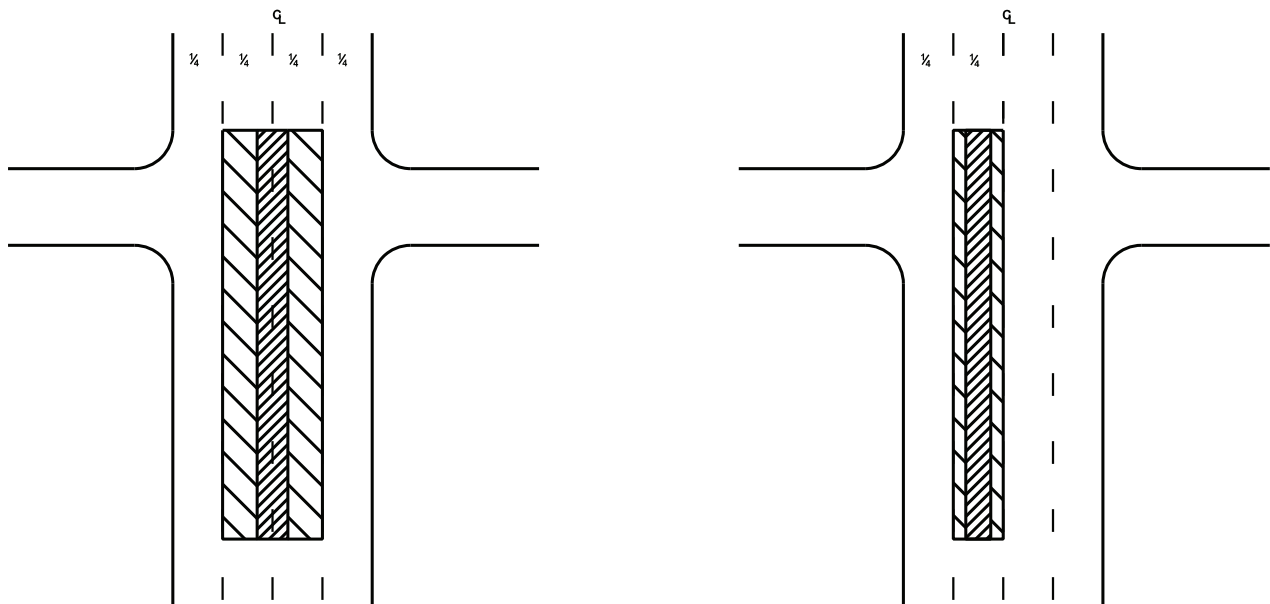

ROAD SURFACE WITH NO LANE MARKINGS

- LEGEND**
- PAVEMENT EDGE
  - - - LANE MARKING
  - ▨ UTILITY CUT
  - ▧ OVERLAY

**ROAD SURFACE RESTORATION AFTER UTILITY CUT**



STANDARD DRAWING

DATE APPROVED: **2018**

DRAWN BY: **KSYC**

APPROVED: *M.R.*

DRAWING NUMBER: **1010**

SCALE: **N.T.S.**

CHECKED BY: **JN**

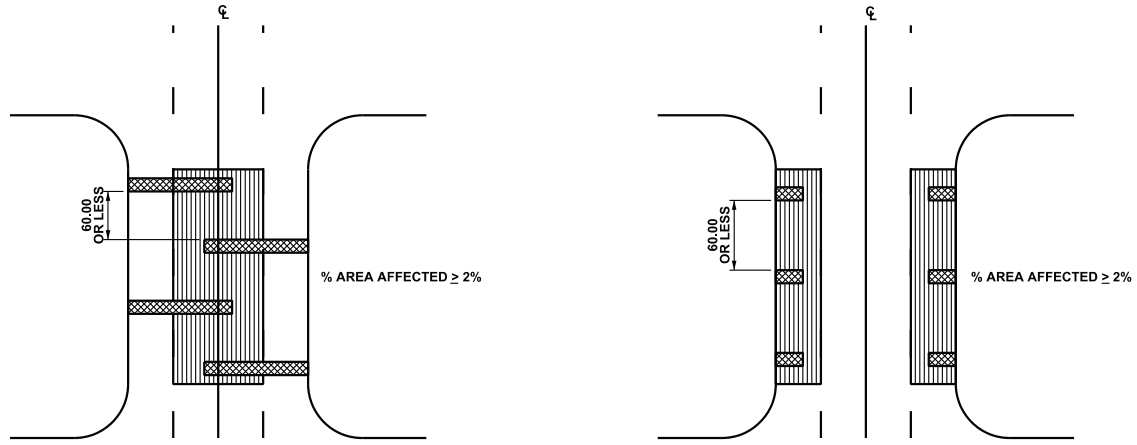

3 YEAR NO-CUT LOCATIONS

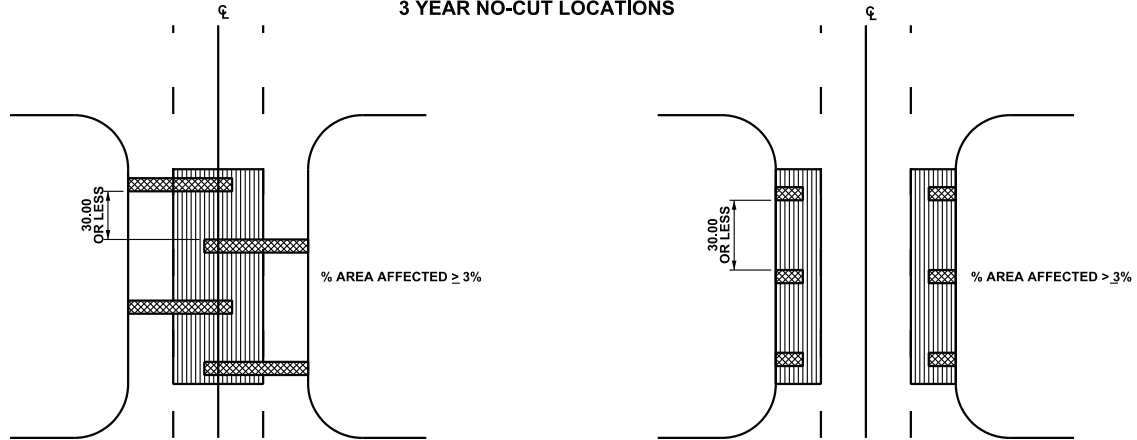

PQI ≥ 5.0 (OTHER LOCATIONS)

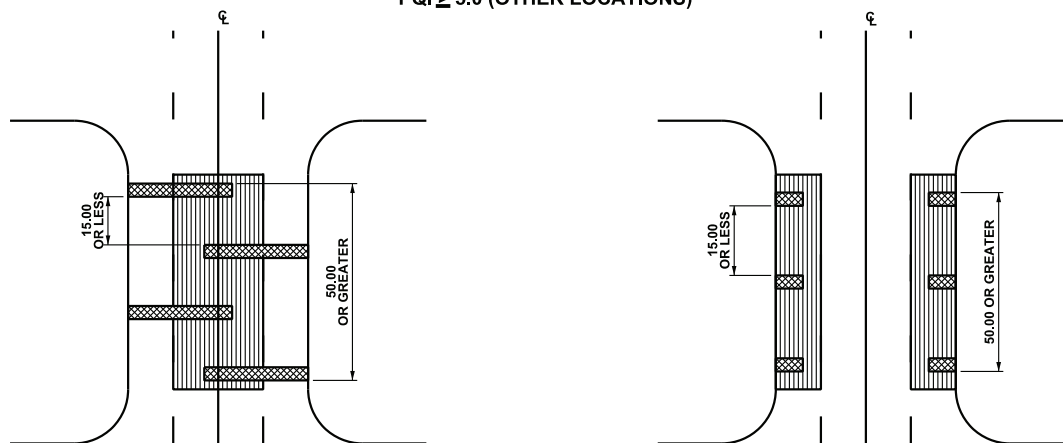

PQI < 5.0 (OTHER LOCATIONS)

LEGEND

- CURB & GUTTER / EDGE OF PAVEMENT
- UTILITY RESTORATION AREA
- REPAIR AREA

$$\% \text{ AREA AFFECTED} = \frac{\text{TOTAL REPAIR AREA}}{\text{UTILITY RESTORATION AREA}} \times 100$$

**ALL DIMENSIONS  
IN METRES UNLESS  
OTHERWISE NOTED**



STANDARD DRAWING

2023-08-31

**TRANSVERSE CUT RESTORATION ARTERIAL ROAD**

DATE APPROVED: **2017**

DRAWN BY: **KSYC**

APPROVED: *M.R.*

DRAWING NUMBER: **1020**

SCALE: **N.T.S.**

CHECKED BY: **JN**

v05

Page 500

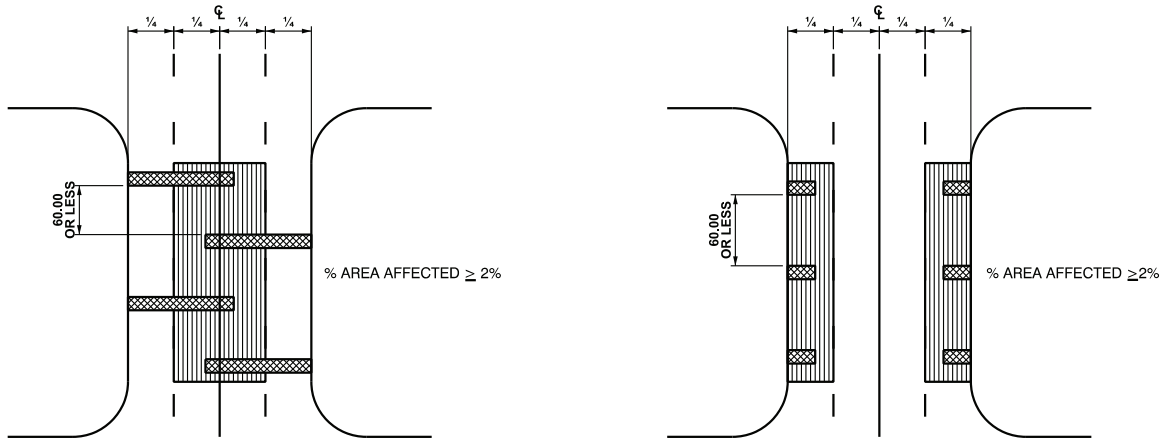

**3 YEAR NO-CUT LOCATIONS**

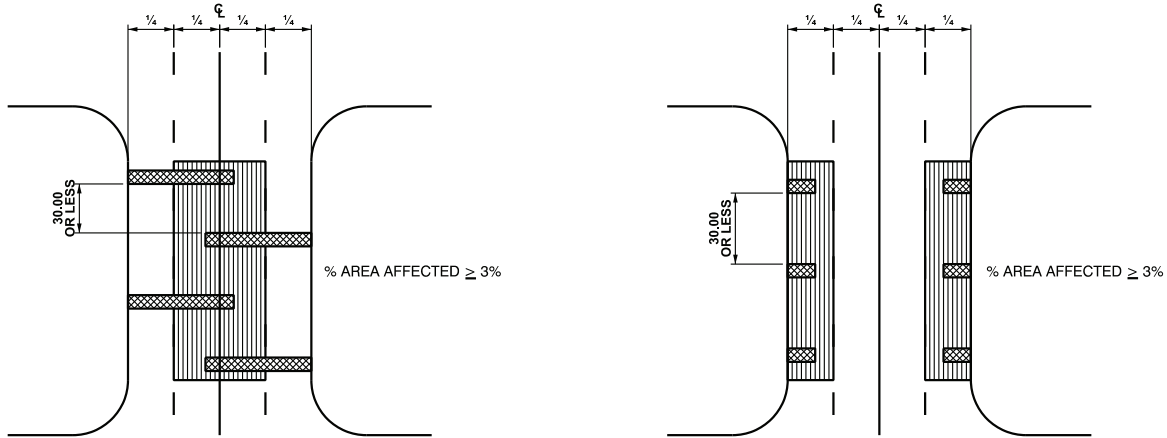

**PQI ≥ 5.0 (OTHER LOCATIONS)**

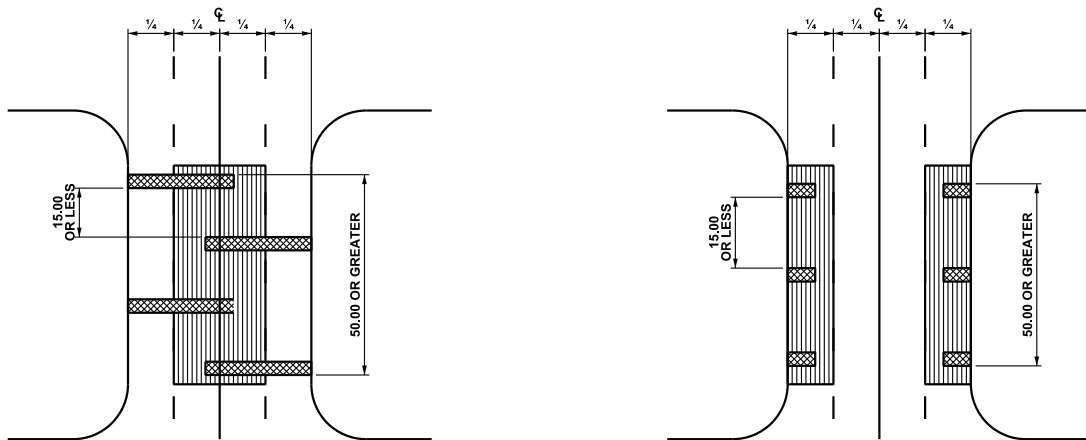

**PQI < 5.0 (OTHER LOCATIONS)**

**LEGEND**

- CURB & GUTTER / EDGE OF PAVEMENT
- UTILITY RESTORATION AREA
- REPAIR AREA

$$\% \text{ AREA AFFECTED} = \frac{\text{TOTAL REPAIR AREA}}{\text{UTILITY RESTORATION AREA}} \times 100$$

**ALL DIMENSIONS  
IN METRES UNLESS  
OTHERWISE NOTED**

STANDARD DRAWING

**TRANSVERSE CUT RESTORATION 14.5m COLLECTOR ROAD**

DATE APPROVED: **2018**  
SCALE: **N.T.S.**

DRAWN BY: **KSYC**  
CHECKED BY: **JN**

APPROVED:

DRAWING NUMBER: **1021**

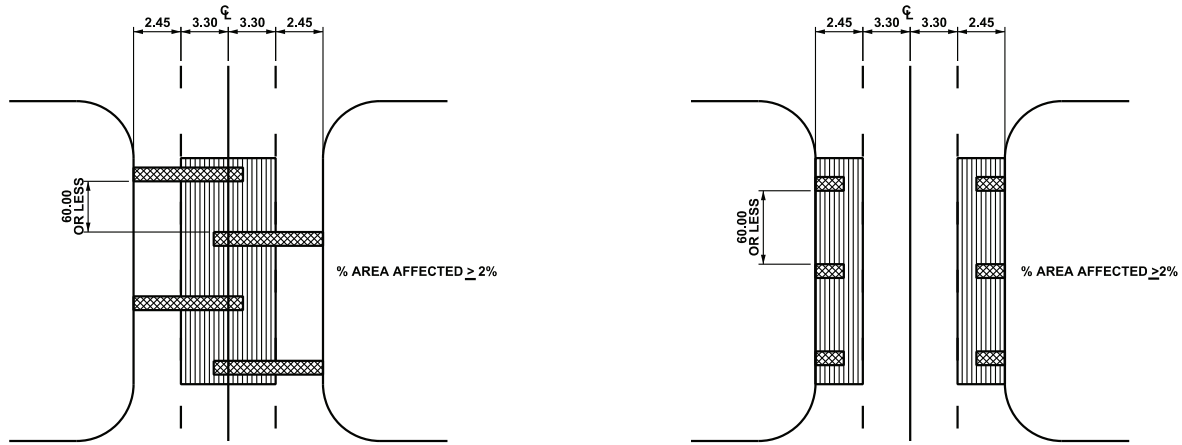

3 YEAR NO-CUT LOCATIONS

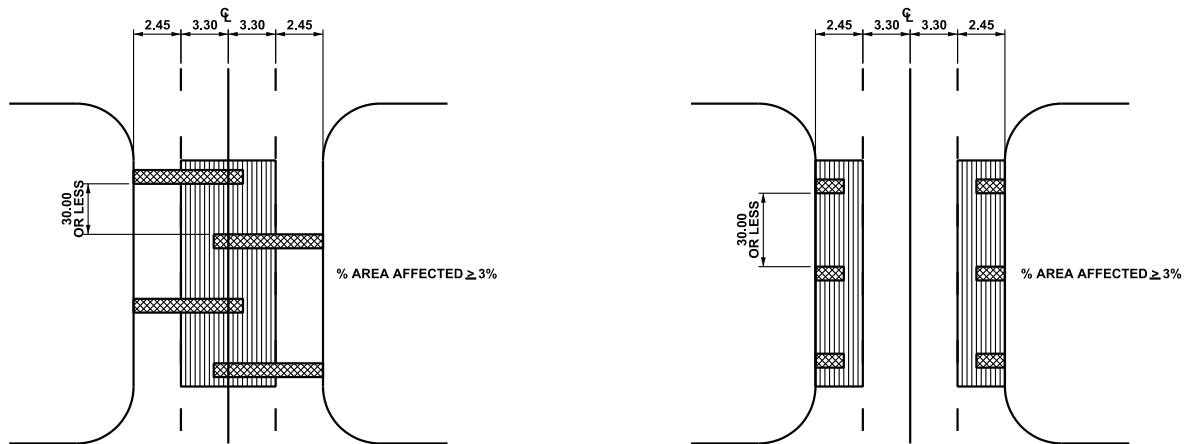

PQI ≥ 5.0 (OTHER LOCATIONS)

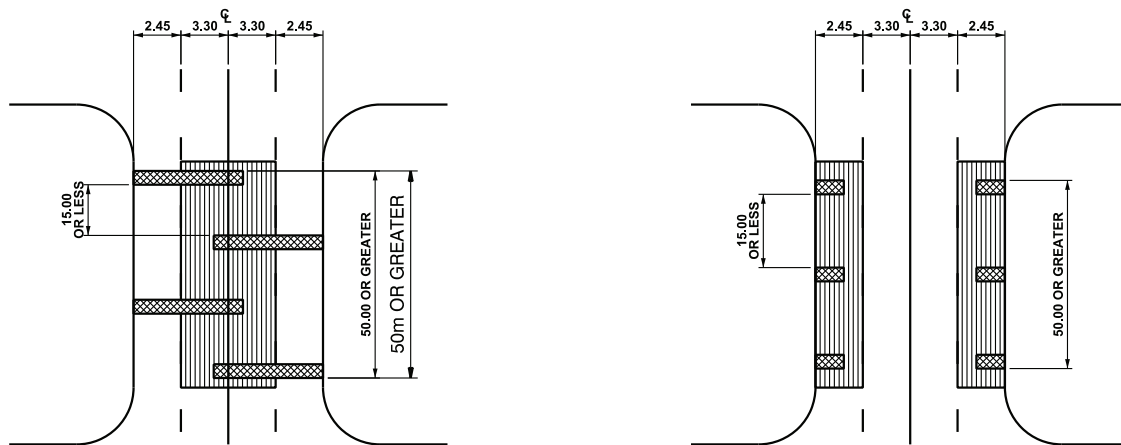

PQI < 5.0 (OTHER LOCATIONS)

LEGEND

- CURB & GUTTER / EDGE OF PAVEMENT
- UTILITY RESTORATION AREA
- REPAIR AREA

$$\% \text{ AREA AFFECTED} = \frac{\text{TOTAL REPAIR AREA}}{\text{UTILITY RESTORATION AREA}} \times 100$$

**ALL DIMENSIONS  
IN METRES UNLESS  
OTHERWISE NOTED**



STANDARD DRAWING

2023-08-31

TRANSVERSE CUT RESTORATION 11.50m COLLECTOR ROAD

DATE APPROVED: **2018**

DRAWN BY: **KSYC**

APPROVED:

DRAWING NUMBER: **1022**

SCALE: **N.T.S.**

CHECKED BY: **JN**

v05

Page 502

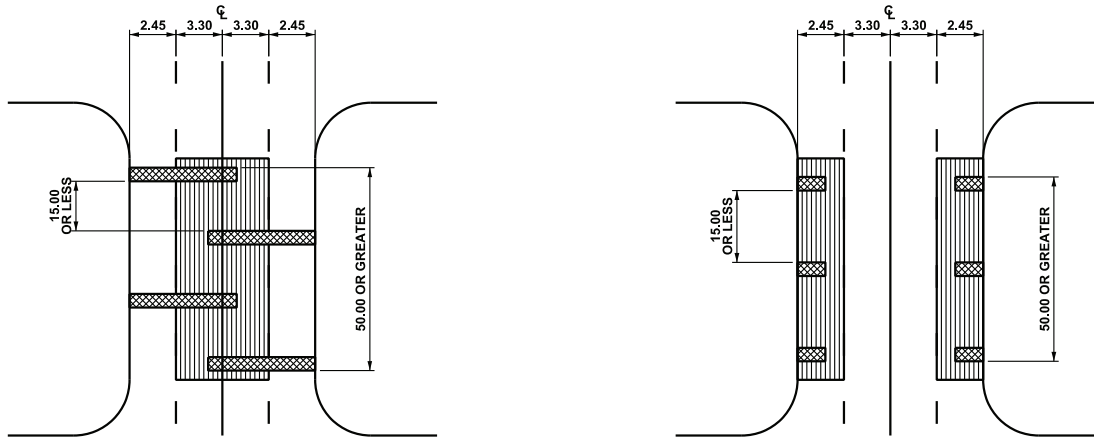

3 YEAR NO-CUT LOCATIONS

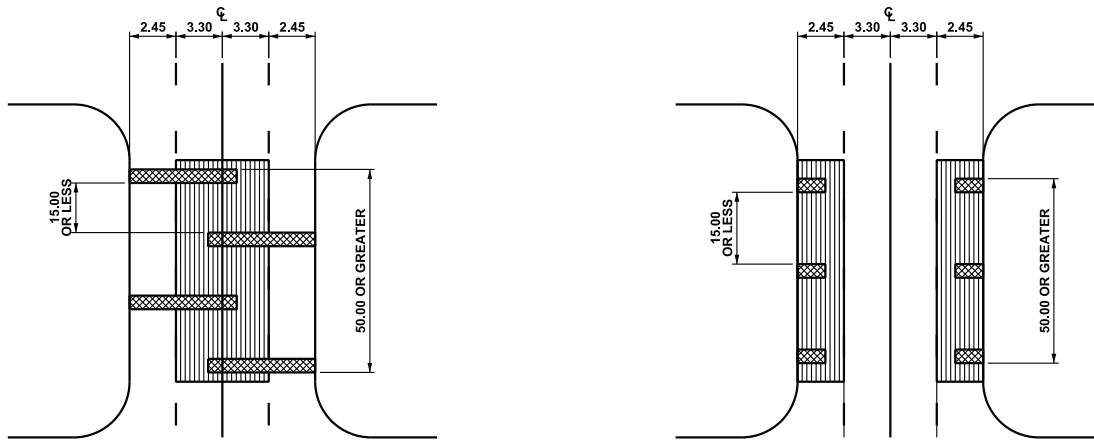

PQI ≥ 5.0 (OTHER LOCATIONS)

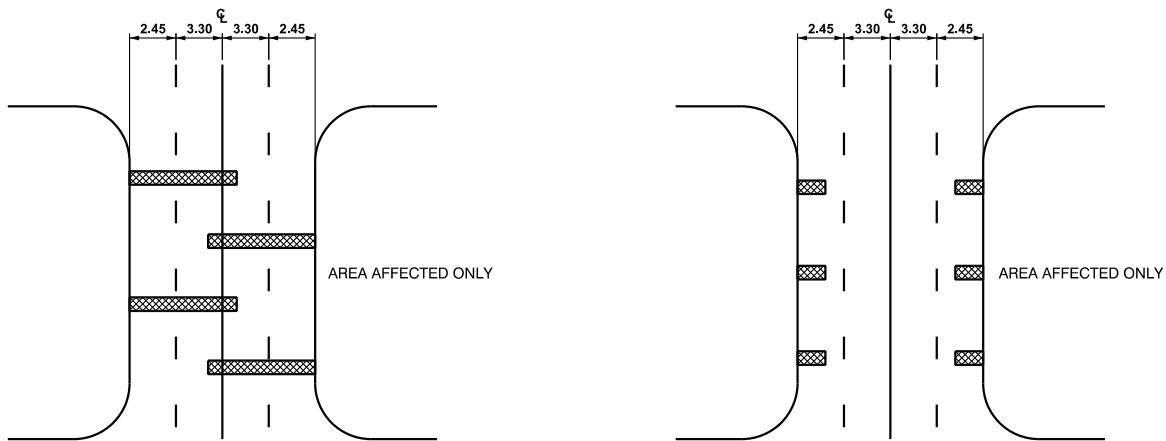

PQI < 5.0 (OTHER LOCATIONS)

LEGEND

- CURB & GUTTER / EDGE OF PAVEMENT
- UTILITY RESTORATION AREA
- REPAIR AREA

$$\% \text{ AREA AFFECTED} = \frac{\text{TOTAL REPAIR AREA}}{\text{UTILITY RESTORATION AREA}} \times 100$$

**ALL DIMENSIONS  
IN METRES UNLESS  
OTHERWISE NOTED**



STANDARD DRAWING

## TRANSVERSE CUT RESTORATION LOCAL INDUSTRIAL ROAD

DATE APPROVED: **2018**

SCALE: **N.T.S.**

DRAWN BY: **KSYC**

CHECKED BY: **JN**

APPROVED: 

DRAWING NUMBER: **1023**

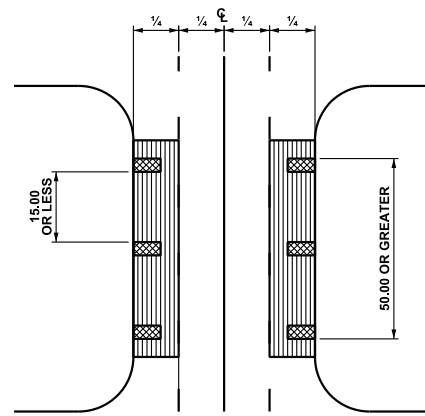
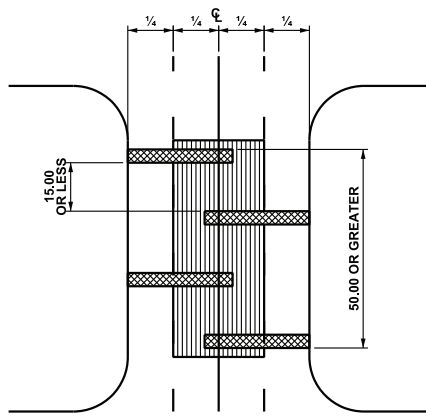

3 YEAR NO-CUT LOCATIONS

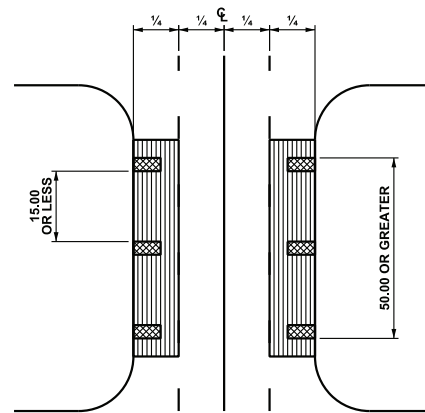
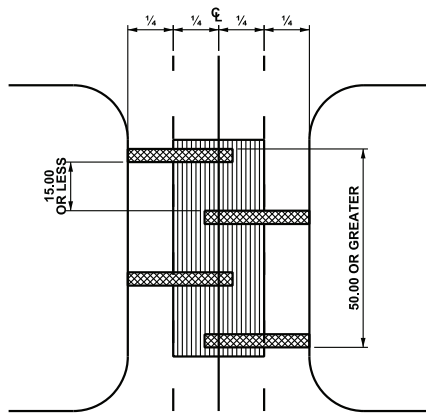

PQI ≥ 5.0 (OTHER LOCATIONS)

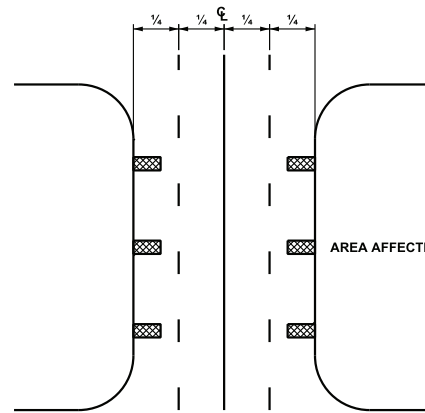
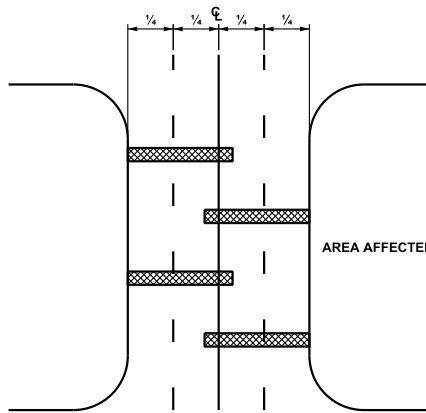

PQI < 5.0 (OTHER LOCATIONS)

LEGEND

- CURB & GUTTER / EDGE OF PAVEMENT
- UTILITY RESTORATION AREA
- REPAIR AREA

$$\% \text{ AREA AFFECTED} = \frac{\text{TOTAL REPAIR AREA}}{\text{UTILITY RESTORATION AREA}} \times 100$$

**ALL DIMENSIONS  
IN METRES UNLESS  
OTHERWISE NOTED**



STANDARD DRAWING

2023-08-31

**TRANSVERSE CUT RESTORATION LOCAL RESIDENTIAL ROAD**

DATE APPROVED: **2018**

DRAWN BY: **KSYC**

APPROVED: *M.A.R.*

DRAWING NUMBER: **1024**

SCALE: **N.T.S.**

CHECKED BY: **JN**

v05

Page 504



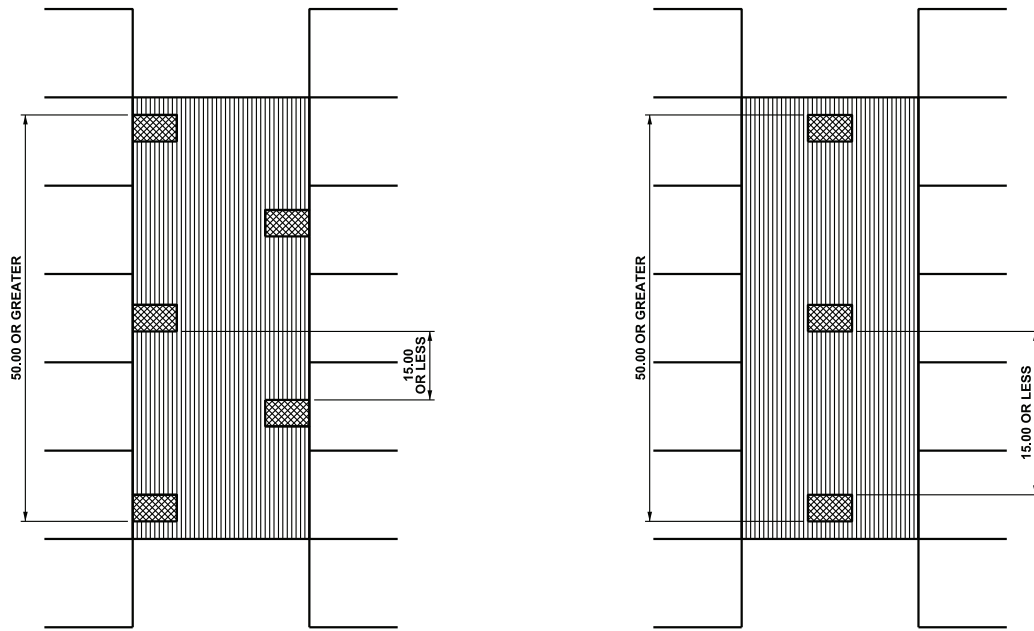

3 YEAR NO-CUT LOCATIONS AND VCI ≥ 5.0 (OTHER LOCATIONS)

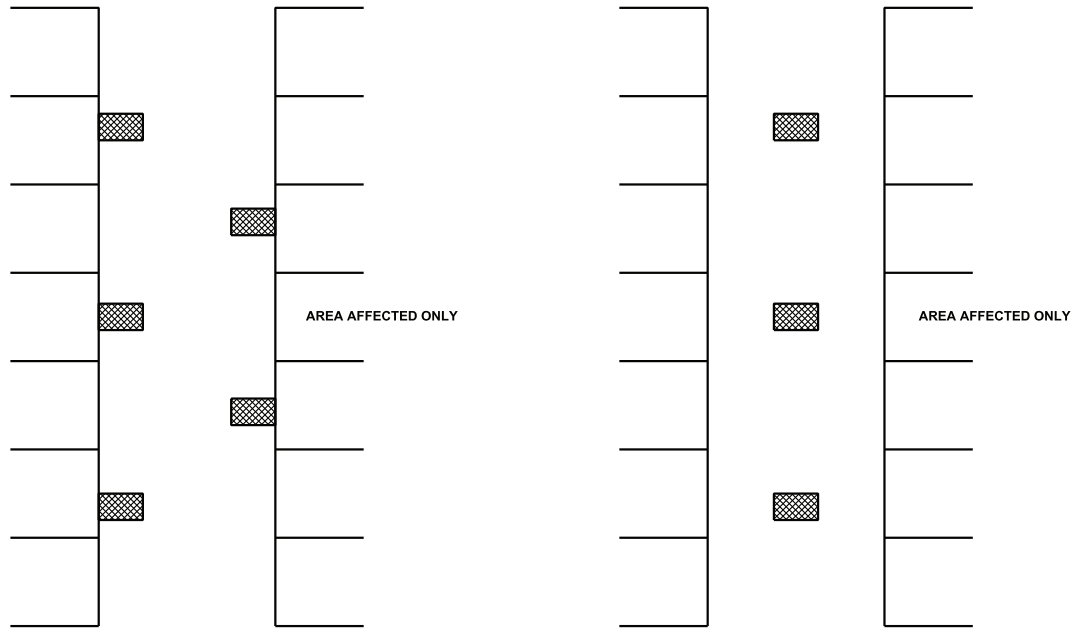

VCI < 5.0 (OTHER LOCATIONS)

LEGEND

- CURB & GUTTER / FENCE LINE
- PROPERTY LINE
- ▨ UTILITY RESTORATION AREA
- ▩ REPAIR AREA

$$\% \text{ AREA AFFECTED} = \frac{\text{TOTAL REPAIR AREA}}{\text{UTILITY RESTORATION AREA}} \times 100$$

**ALL DIMENSIONS  
IN METRES UNLESS  
OTHERWISE NOTED**



STANDARD DRAWING

2023-06-21

TRANSVERSE CUT RESTORATION ALLEYS

DATE APPROVED: 2018

DRAWN BY: KSYC

APPROVED: *M.R.*

DRAWING NUMBER: 1025

SCALE: N.T.S.

CHECKED BY: JN

v04

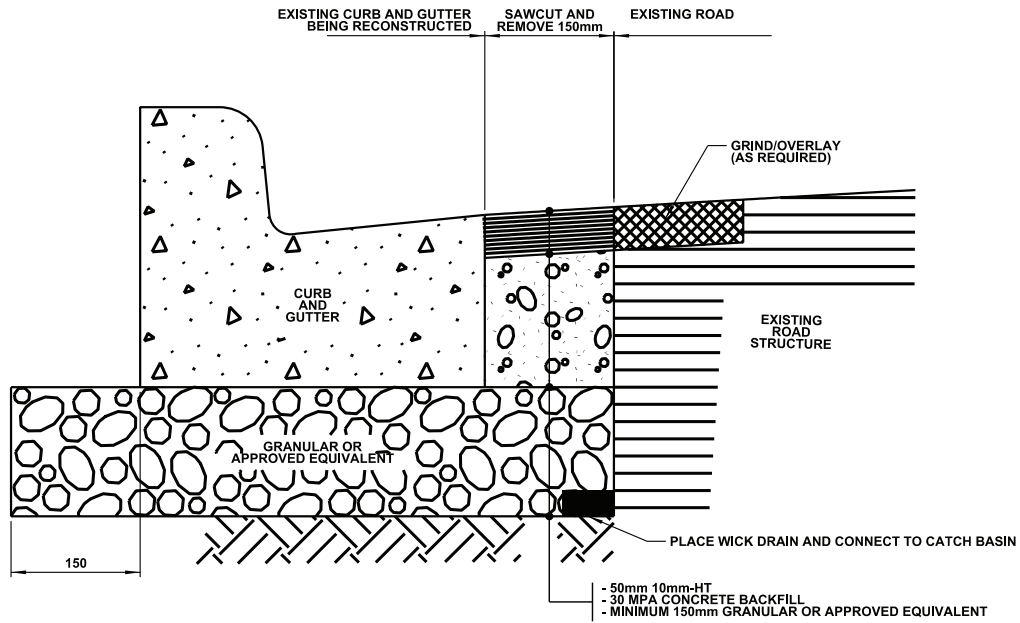

**CURB AND GUTTER REPLACEMENT**

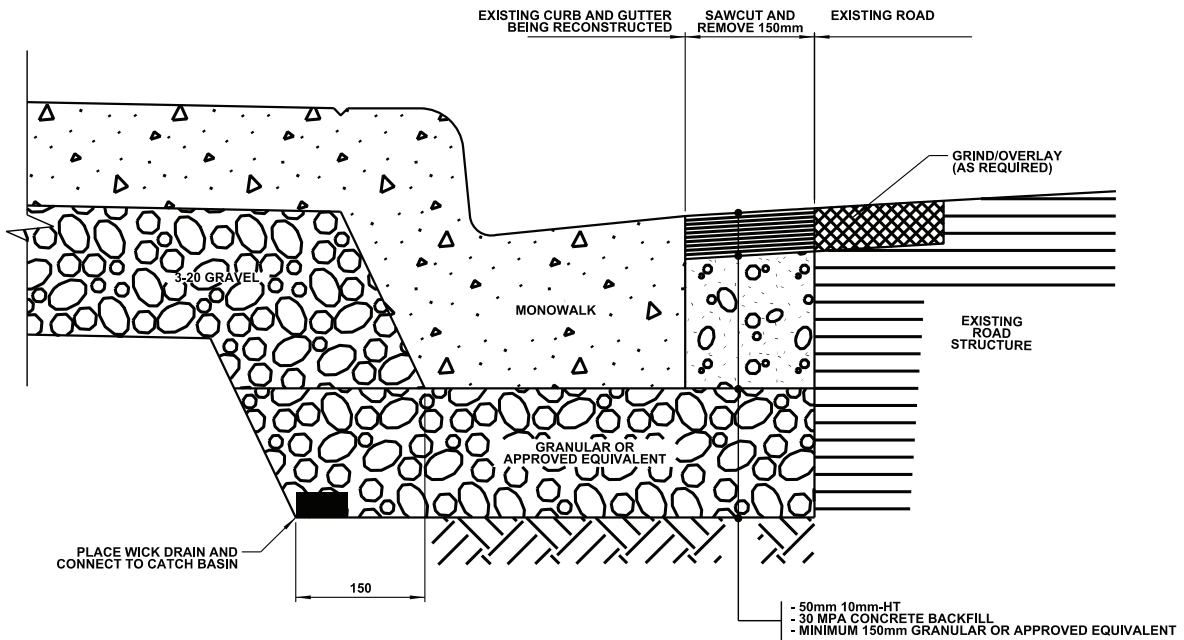

**MONOWALK REPLACEMENT**

**ALL DIMENSIONS  
IN MILLIMETRES UNLESS  
OTHERWISE NOTED**

STANDARD DRAWING

**CURB AND GUTTER / MONOWALK REPLACEMENT  
SAWCUT DETAILS**

DATE APPROVED: **2018**

SCALE: **N.T.S.**

DRAWN BY: **KSYC**

CHECKED BY: **JN**

APPROVED: *M.A.R.*

DRAWING NUMBER: **1030**



## Standard Drawings

### SECTION 2000 – Cross-Sections

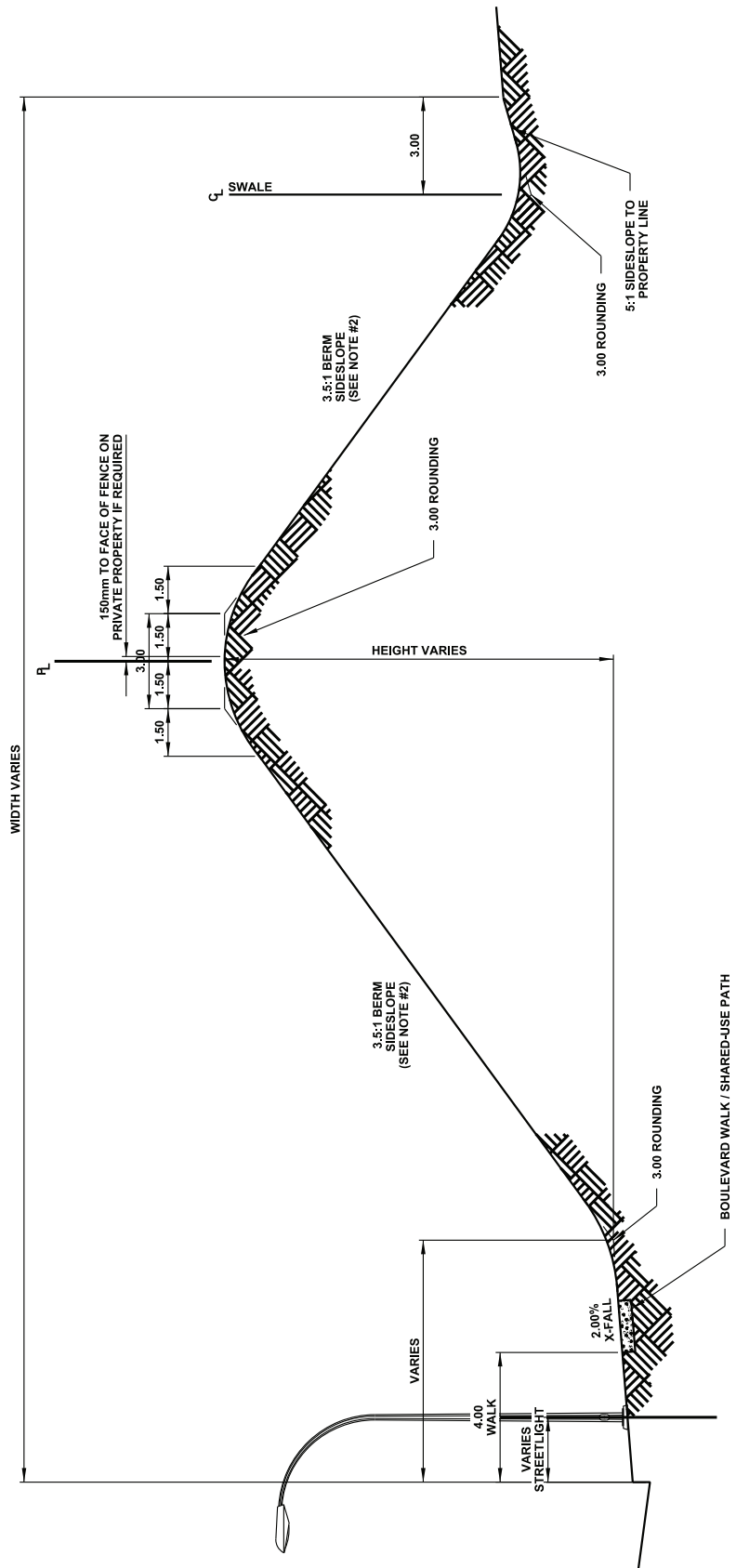

ALL DIMENSIONS  
IN METRES UNLESS  
OTHERWISE NOTED

- NOTE:
1. THE ABOVE DIAGRAM INDICATES THE DESIRABLE BERM FORMAT FOR MAXIMUM HEIGHT OF BERM.
  2. BERM SIDESLOPE MAXIMUM IS 3:1, SUBJECT TO APPROVAL BY CITY OF EDMONTON.
  3. PROPERTY LINE SWALE IS SUBJECT TO LOT GRADING DESIGN.

TYPICAL BERM SECTION



STANDARD DRAWING

DATE APPROVED: 2018

DRAWN BY: KSYC

APPROVED: *M.A.R.*

DRAWING NUMBER: 2000

SCALE: N.T.S.

CHECKED BY: JN

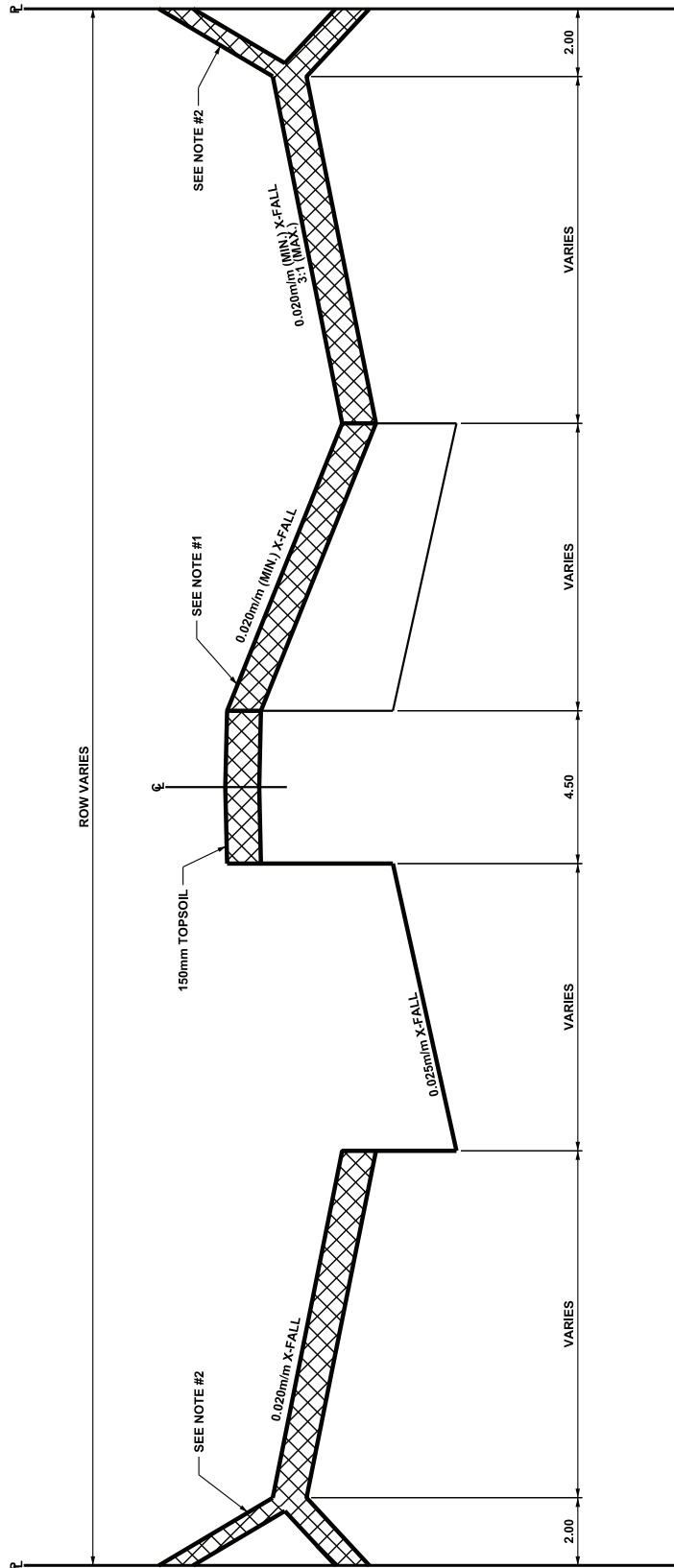

**ALL DIMENSIONS  
IN METRES UNLESS  
OTHERWISE NOTED**

- NOTES:**
- WHERE ONLY ONE HALF OF THE ARTERIAL ROADWAY IS TO BE CONSTRUCTED AND THE COMPLETE RIGHT OF WAY EXISTS, THE UNCONSTRUCTED PORTION SHALL BE GRADED TO THIS LINE AND DRAINAGE INSTALLED.
  - GRADE TO MEET THE EXISTING GROUND. IF THE CUT IS IN EXCESS OF 2.00 METERS, SPECIAL GRADES WILL BE SET.



STANDARD DRAWING

2023-06-21

**STAGED ARTERIAL GRADING REQUIREMENTS**

DATE APPROVED: **2018**

SCALE: **N.T.S.**

DRAWN BY: **KSYC**

CHECKED BY: **JN**

APPROVED: *M.L.R.*

DRAWING NUMBER: **2020**

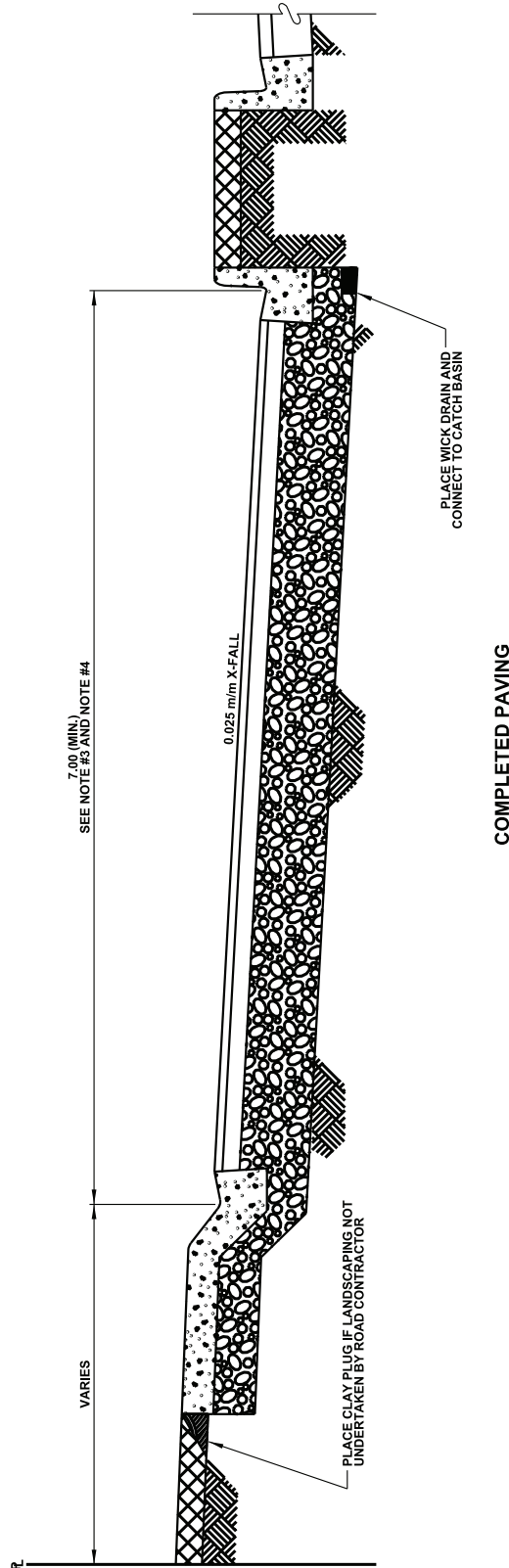

ALL DIMENSIONS  
IN METRES UNLESS  
OTHERWISE NOTED

NOTES:

1. PAVEMENT STRUCTURE TO BE APPROVED BY CITY OF EDMONTON.
2. X-FALL TO BE MEASURED FROM LIP OF GUTTER.
3. 7.00m FOR FLANKAGE ON RESIDENTIAL LOTS.
4. 8.40m FOR FRONTING ON RESIDENTIAL LOTS.
5. PLACE CLAY PLUG IF LANDSCAPING NOT UNDERTAKEN BY ROAD CONTRACTOR.

RESIDENTIAL SERVICE ROAD



STANDARD DRAWING

DATE APPROVED: **2018**

DRAWN BY: **KSYC**

APPROVED: *M.L.R.*

DRAWING NUMBER: **2030**

SCALE: **N.T.S.**

CHECKED BY: **JN**

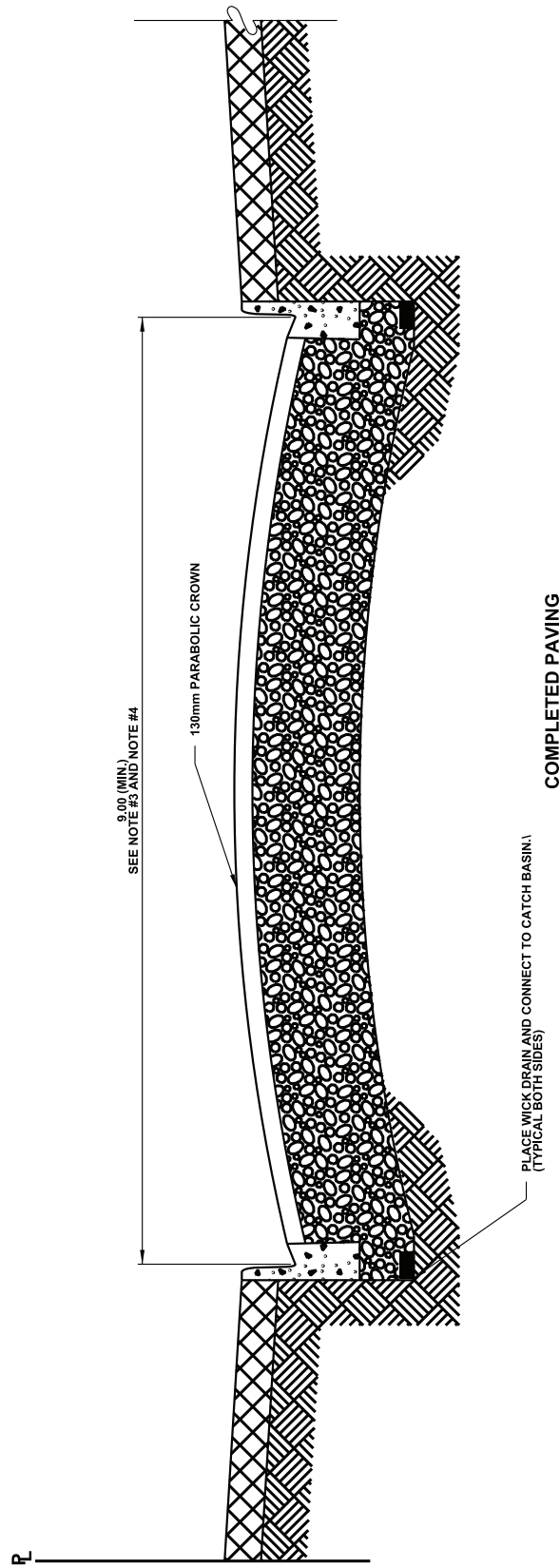

ALL DIMENSIONS  
IN METRES UNLESS  
OTHERWISE NOTED

NOTES:

1. PAVEMENT STRUCTURE TO BE APPROVED BY CITY OF EDMONTON.
2. CROWN TO BE MEASURED FROM LIP OF GUTTER.
3. 9.00m FOR FLANKAGE LOTS WITHOUT ACCESS.
4. 10.50m FOR FRONTING LOTS WITH ACCESS.



**INDUSTRIAL SERVICE ROAD**

DATE APPROVED: **2018**  
SCALE: **N.T.S.**

DRAWN BY: **KSYC**  
CHECKED BY: **JN**

APPROVED: *M.A.R.*

DRAWING NUMBER: **2031**

STAGED ASPHALT PAVEMENT		MINIMUM THICKNESS (mm)	
MATERIAL	EDGE	CENTER	EDGE
ASPHALT - 10mm-LT (FINAL LIFT)	35	35	35
ASPHALT - 10mm-LT (FIRST LIFT)	65	65	65
GRANULAR BASE COURSE - DES 3 CLASS 20 (2 LIFTS) <sup>2,3</sup>	225	225	300
ALTERNATE GRANULAR BASE COURSE - DES 3 CLASS 20 (TOP LIFT) <sup>3</sup> - DES 3 CLASS 63 (BOTTOM LIFT) <sup>2</sup>	125 150	125 150	125 225

UNSTAGED ASPHALT PAVEMENT		MINIMUM THICKNESS (mm)	
MATERIAL	EDGE	CENTER	EDGE
ASPHALT - 10mm-LT (SINGLE LIFT) <sup>1</sup>	100	100	100
GRANULAR BASE COURSE - DES 3 CLASS 20 (2 LIFTS) <sup>2,3</sup>	300	225	300
ALTERNATE GRANULAR BASE COURSE - DES 3 CLASS 20 (TOP LIFT) <sup>3</sup> - DES 3 CLASS 63 (BOTTOM LIFT) <sup>2</sup>	125 225	125 150	125 225

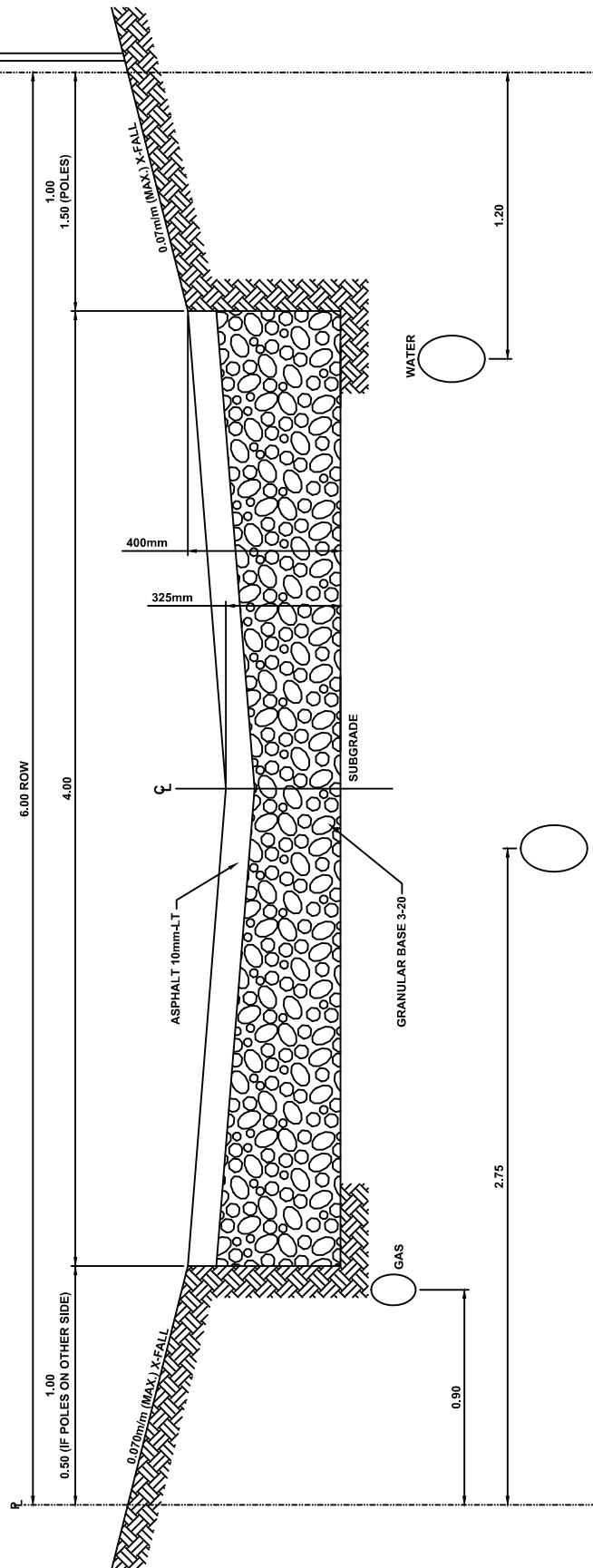

**ALL DIMENSIONS  
IN METRES UNLESS  
OTHERWISE NOTED**

**NOTES:**

- 10mm-LT PLACEMENT IN A SINGLE 100mm LIFT IS RESTRICTED TO ALLEY PAVING
- ATOP PREPARED SUBGRADE AND NON-WOVEN GEOTEXTILE OR CEMENT STABILIZED SUBGRADE
- REDUCE CENTRELINE "V" BY 50.00mm AT TIE-IN TO BACK OF BOULEVARD WALK TO FACILITATE DRAINAGE AS REQUIRED.
- DEPTH OF GAS TRENCH TO BE MINIMUM 1.10m.
- EDGES OF PAVEMENT TO BE WARPED TO FIT DRIVEWAYS.
- ALLEY IS CENTERED IN ROW UNLESS THERE ARE POLES.

**4.00m RESIDENTIAL ALLEY**



STANDARD DRAWING

2023-08-31

DATE APPROVED: **2023**

SCALE: **N.T.S.**

DRAWN BY: **MW**

CHECKED BY: **CF**

APPROVED: *Cherie Fuchs*  
Cherie Fuchs 2023-Aug-01

DRAWING NUMBER: **2040**

v05



UNSTAGED ASPHALT PAVEMENT	MINIMUM THICKNESS (mm)	
MATERIAL	CENTER	EDGE
ASPHALT - 10mm-LT (SURFACE LIFT)	50	50
ASPHALT - 20mm-B (BOTTOM LIFT)	75	75
GRANULAR BASE COURSE - DES 3 CLASS 20 (2 LIFTS) <sup>1,2</sup>	300	375
ALTERNATE GRANULAR BASE COURSE - DES 3 CLASS 20 (TOP LIFT) <sup>1,2</sup> - DES 3 CLASS 63 (BOTTOM LIFT)	150 150	150 225

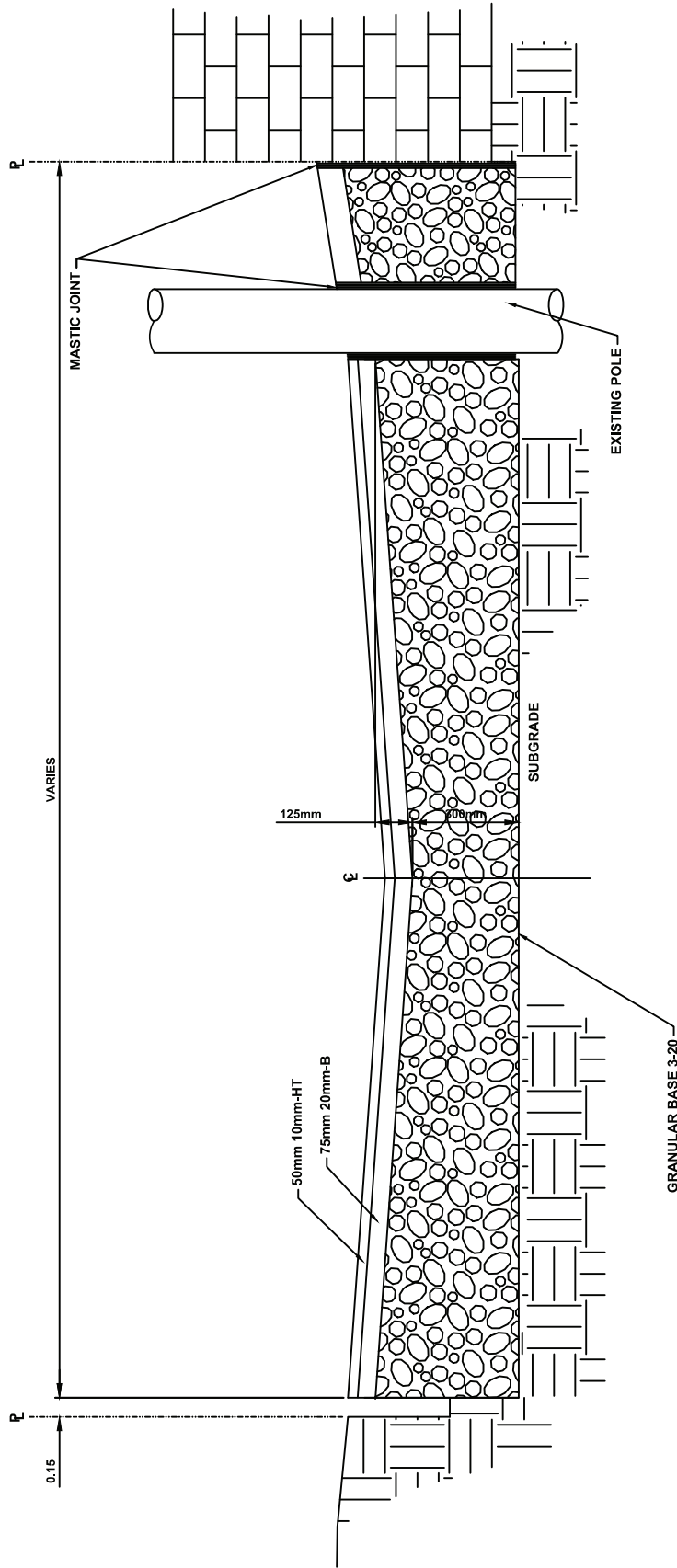

**ALL DIMENSIONS  
IN METRES UNLESS  
OTHERWISE NOTED**

- NOTES:**
1. ATOP PREPARED SUBGRADE AND NON-WOVEN GEOTEXTILE OR CEMENT STABILIZED SUBGRADE
  2. REDUCE CENTRELINE "V" BY 50mm AT TIE-IN TO BACK OF BOULEVARD WALK TO FACILITATE DRAINAGE AS REQUIRED.
  3. IN ALLEY CONSTRUCTION, THE SAG POINT MAY BE OFF CENTERED AND/OR THE CROSS-FALL VARIED TO MATCH EXISTING GRADES ALONG THE ALLEY EDGES.
  4. EXCAVATION LIMITS TO BE AS SHOWN ABOVE.

**6.00m COMMERCIAL ALLEY**

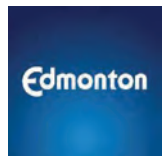

STANDARD DRAWING

2023-08-31

DATE APPROVED: **2023**

SCALE: **N.T.S.**

DRAWN BY: **MW**

CHECKED BY: **CF**

APPROVED: *Cherie Fucie*  
Cherie Fucie 2023-Aug-06

DRAWING NUMBER: **2041**

v05

Page 513

**NOTES:**

1. **EDGE OF PAVEMENT TO BE WARPED TO MATCH DRIVEWAY.**
2. **REDUCE CENTERLINE "V" TO 50mm AT TIE-IN TO BACK OF BOULEVARD WALK TO FACILITATE DRAINAGE AS REQUIRED.**
3. **REFER TO STREETLIGHTING STANDARDS (VOLUME 6) FOR STREETLIGHT CABLE DEPTH.**

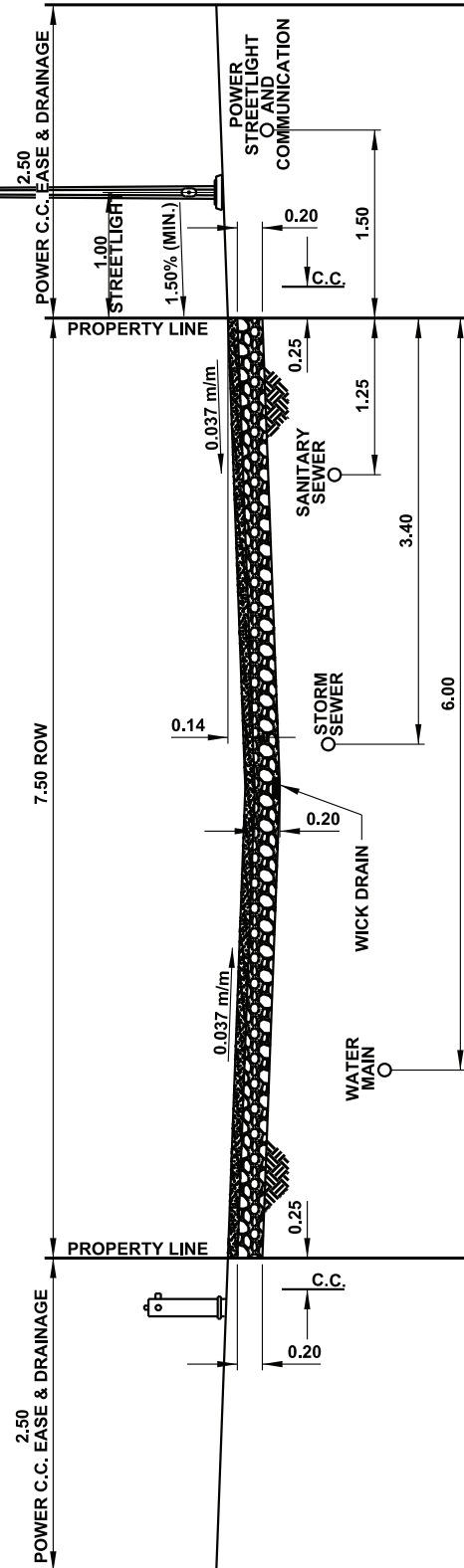

**STAGED ASPHALT CONSTRUCTION**  
 - 35mm 10mm-LT AT F.A.C.  
 - 65mm 10mm-LT  
 - 200mm 3-20A CRUSHED GRAVEL  
 - 150MM CEMENT STABILIZED SUBGRADE  
 (10kg/m<sup>2</sup> MIN. TO BE VERIFIED BY A GEOTECHNICAL ENGINEER AT TIME OF CONSTRUCTION)

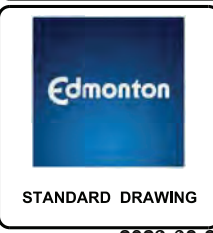

**RESIDENTIAL REVERSE HOUSING ALLEY - 7.50m ROW**

DATE APPROVED: **2018**  
 SCALE: **N.T.S.**

DRAWN BY: **KSYC**  
 CHECKED BY: **JN**

APPROVED: *M.A.R.*

DRAWING NUMBER: **2042**

**NOTES:**

1. EDGE OF PAVEMENT TO BE WARPED TO MATCH DRIVEWAY.
2. REDUCE CENTERLINE "V" TO 50mm AT TIE-IN TO BACK OF BOULEVARD WALK TO FACILITATE DRAINAGE AS REQUIRED.
3. REFER TO STREETLIGHTING STANDARDS (VOLUME 6) FOR STREETLIGHT CABLE DEPTH.

**STAGED ASPHALT CONSTRUCTION**  
 - 35mm 10mm-LT AT F.A.C  
 - 65mm 10mm-LT  
 - 200mm 3-20A CRUSHED GRAVEL  
 - 150mm CEMENT STABILIZED SUBGRADE (10kg/m<sup>2</sup> MIN. TO BE VERIFIED BY A GEOTECHNICAL ENGINEER AT TIME OF CONSTRUCTION)

**LEGEND:**

P PARKING LANE

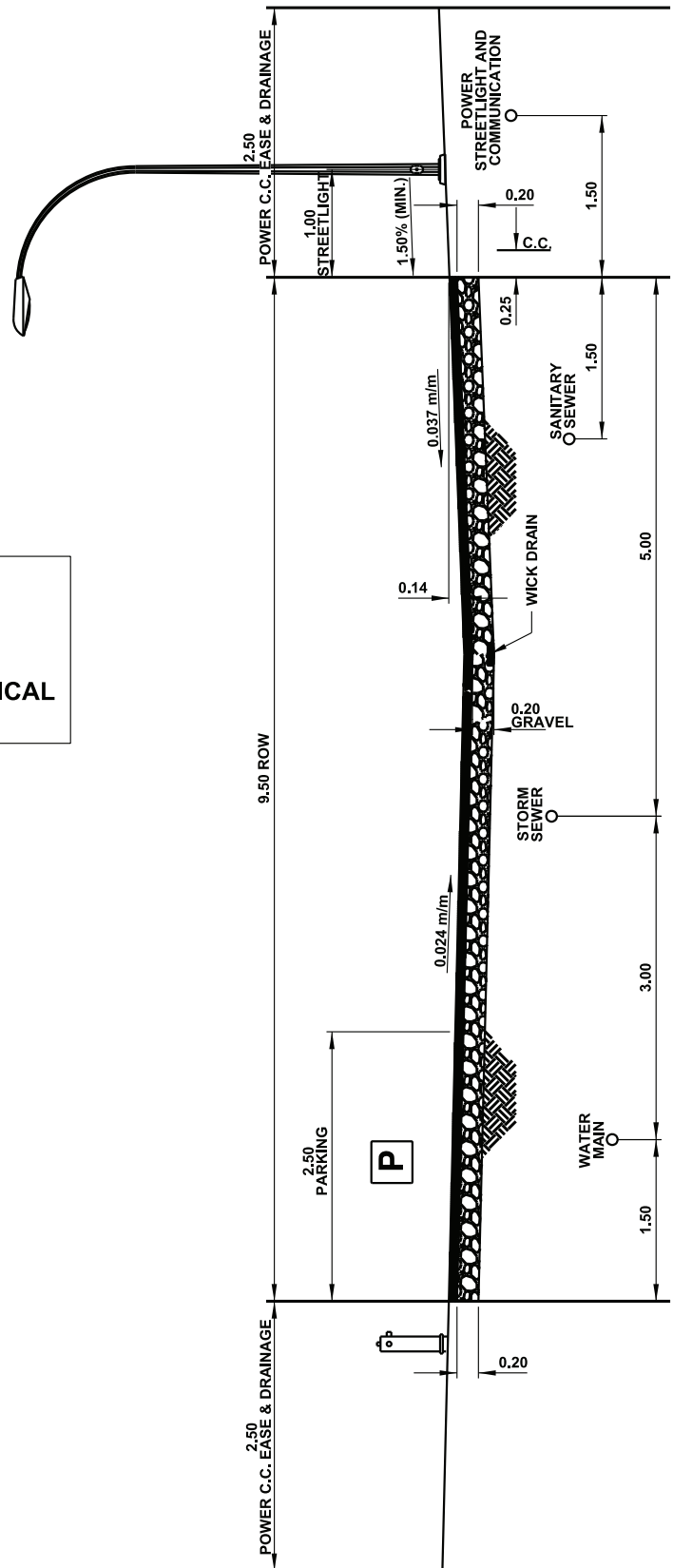

STANDARD DRAWING

2023-06-21

**REVERSE HOUSING ALLEY WITH PARKING - 9.50m ROW**

DATE APPROVED: **2018**

SCALE: **N.T.S.**

DRAWN BY: **KSYC**

CHECKED BY: **JN**

APPROVED: *M.A.R.*

DRAWING NUMBER: **2043**

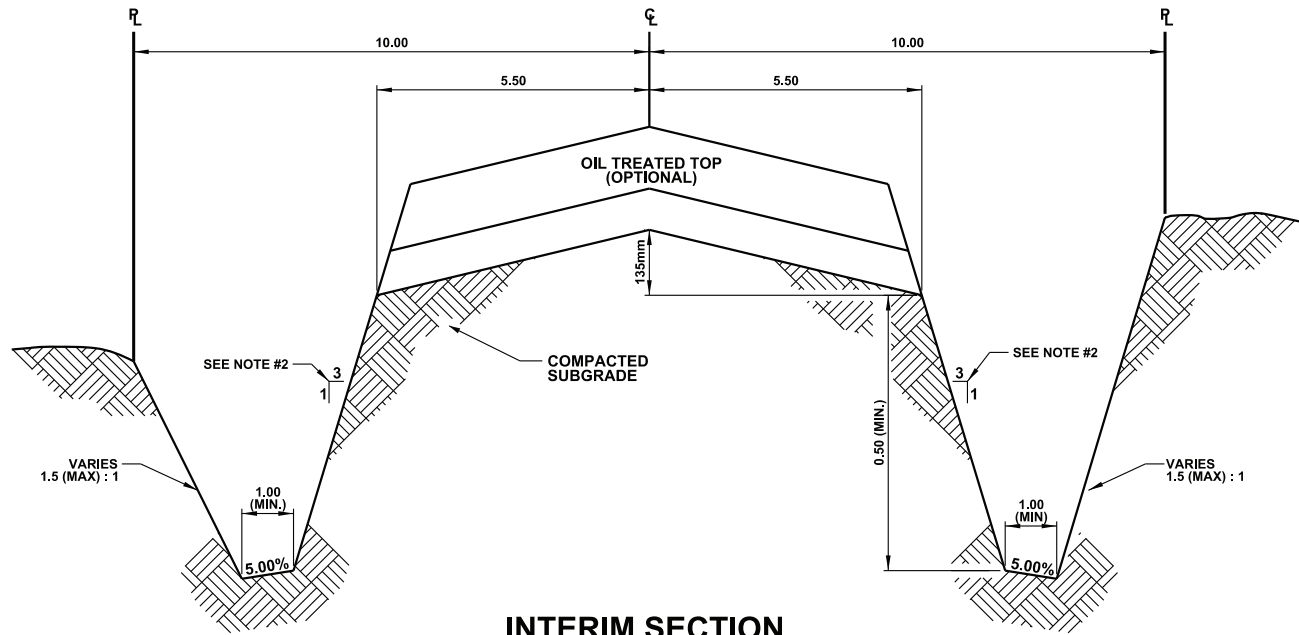

**INTERIM SECTION**

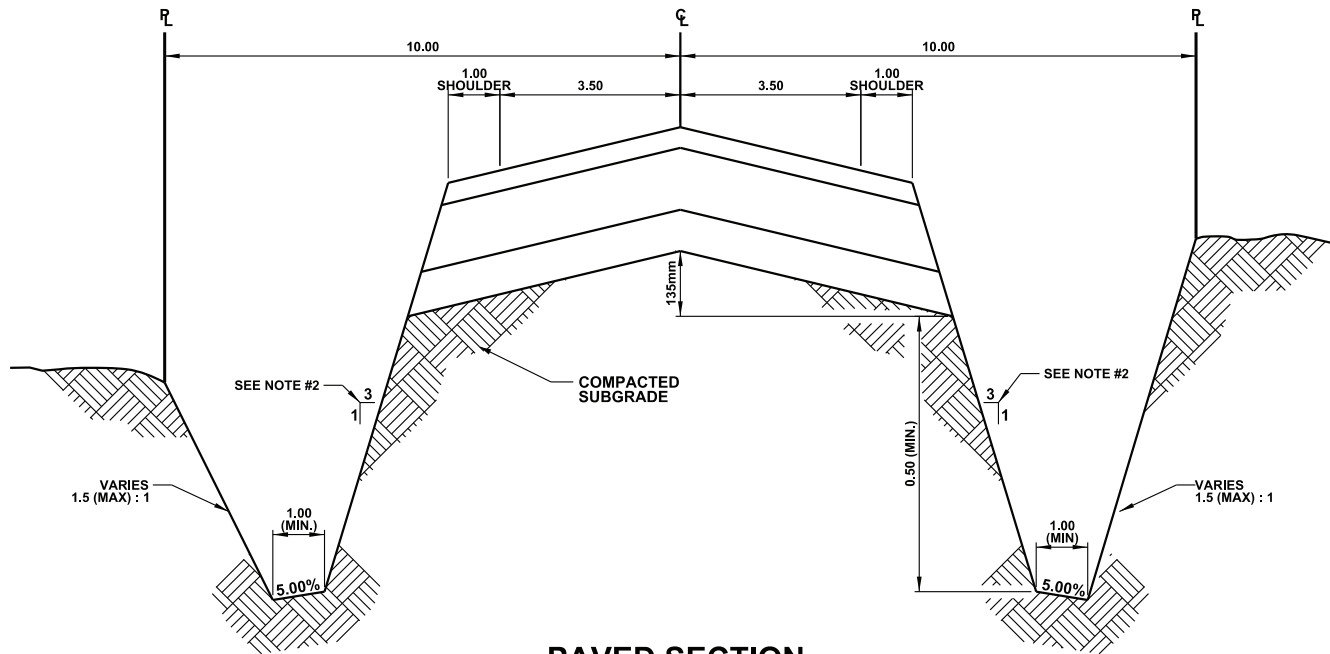

**PAVED SECTION**

**NOTES:**

1. ENGINEERING FABRIC TO BE PLACED BETWEEN SUBGRADE AND BASE WHEN A WET SUBGRADE IS ENCOUNTERED, AS DIRECTED BY THE ENGINEER.
2. SIDESLOPE DEPENDS ON DESIGN SPEED AND TRAFFIC VOLUME, REFER TO TAC GUIDELINES.
3. REVIEW GEOTECHNICAL AND STABILITY TO DETERMINE REQUIREMENT FOR GUARDRAILS, REFER TO TAC GUIDELINES.
4. PAVEMENT STRUCTURE TO BE DETERMINED BASED ON GEOTECHNICAL REVIEW AND SATISFACTION OF CITY OF EDMONTON STANDARD.

**ALL DIMENSIONS  
IN METRES UNLESS  
OTHERWISE NOTED**



STANDARD DRAWING

2023-06-21

**9.00m RURAL LOCAL / COLLECTOR ROADWAY**

DATE APPROVED: **2018**

SCALE: **N.T.S.**

DRAWN BY: **KSYC**

CHECKED BY: **JN**

APPROVED: *M.R.*

DRAWING NUMBER: **2050**

Page 286

v04

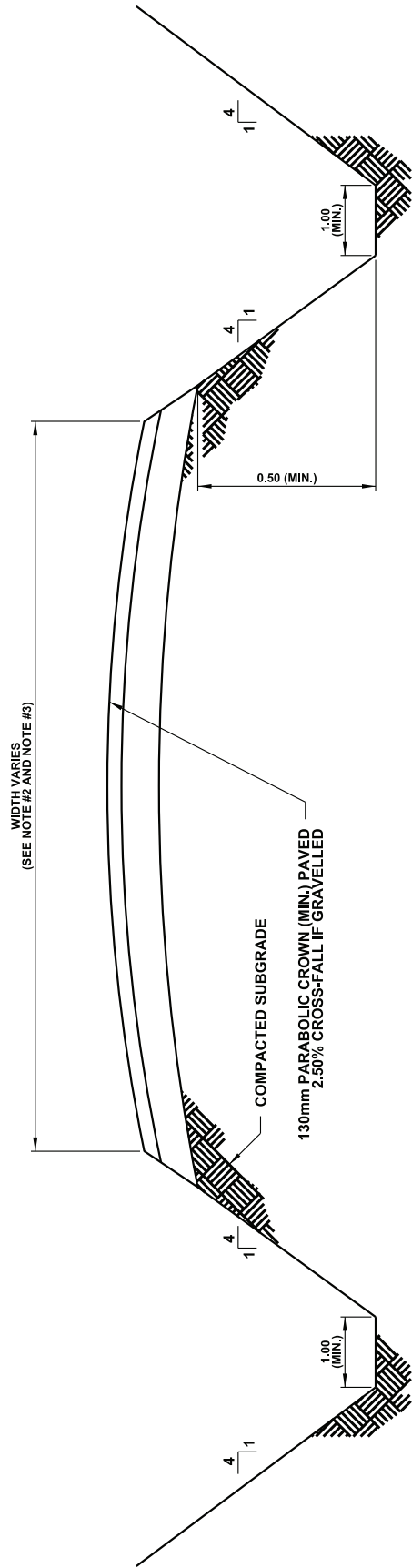

**ALL DIMENSIONS  
IN METRES UNLESS  
OTHERWISE NOTED**

- NOTE:**
1. GEOTEXTILE FABRIC TO BE PLACED ON SUBGRADE, AS DIRECTED BY THE ENGINEER.
  2. MINIMUM WIDTH FOR TWO-LANE OPERATIONS IS 6.00m FOR TEMPORARY ACCESS AND 7.00m FOR DETOUR ROAD.
  3. MINIMUM WIDTH FOR ONE-LANE OPERATIONS IS 3.00m FOR TEMPORARY ACCESS AND 3.50m FOR DETOUR ROAD.
  4. PAVEMENT STRUCTURE TO BE DETERMINED BASED ON GEOTECHNICAL REVIEW AND SATISFACTION OF CITY OF EDMONTON STANDARD.
  5. BACKSLOPE ARE SUBJECT TO GEOTECHNICAL REPORT AND RIGHT-OF-WAY ALLOWANCE.

**TEMPORARY ACCESS / DETOUR ROAD**



STANDARD DRAWING

DATE APPROVED: **2018**

DRAWN BY: **KSYC**

APPROVED: *M.L.R.*

DRAWING NUMBER: **2060**

SCALE: **N.T.S.**

CHECKED BY: **JN**

NOTES:

1. WATER TO BE ON OPPOSITE SIDE OF MAIN POWER.
2. PIPE SIZES AND DEPTH VARY.
3. LANDSCAPING MUST NOT COVER POLE BASE.
4. DEPTH OF MAIN POWER, TELEPHONES AND CABLE T.V. TRENCH TO BE MINIMUM 1.10m.
5. DEPTH OF GAS TRENCH TO BE MINIMUM 1.10m WITHIN ROAD ROW.
6. VERTICAL SEPARATION BETWEEN POWER AND GAS TO BE MINIMUM 0.30m.
7. GAS MAIN LOCATED ON EASEMENTS.
8. SERVICE BOX FOR POWER, TELEPHONE AND CABLE T.V. TO STRADDLE PROPERTY LINE.
9. PLACE CLAY PLUG IF LANDSCAPING NOT UNDERTAKEN BY ROAD CONTRACTOR.
10. MONOWALK WIDTH TO BE MINIMUM 1.80m.
11. HORIZONTAL SEPARATION BETWEEN TREES AND ALL CONCRETE INFRASTRUCTURE TO BE MINIMUM 1.50m.
12. CROWNS ARE MEASURED FROM LIP OF GUTTER.
13. PARKING ALLOWED ON ONE SIDE ONLY.
14. HYDRANT CONTROL VALVE TO BE STRAPPED TO TEE OR TO AN L-SHAPE HYDRANT LEAD TO BE UTILIZED AT THE SOLE DISCRETION OF EPCOR WATER.
15. STREETLIGHT CABLE CAN BE INSTALLED AT THE SAME ALIGNMENT AS POWER AND COMMUNICATIONS.
16. MULTI-PARTY UTILITIES TRENCHING EASEMENT REFER TO DETAIL #5700.
17. ADDITIONAL EASEMENT MAY BE REQUIRED FOR EPCOR POWER STREET FURNITURE.

ALL DIMENSIONS IN METRES UNLESS OTHERWISE NOTED

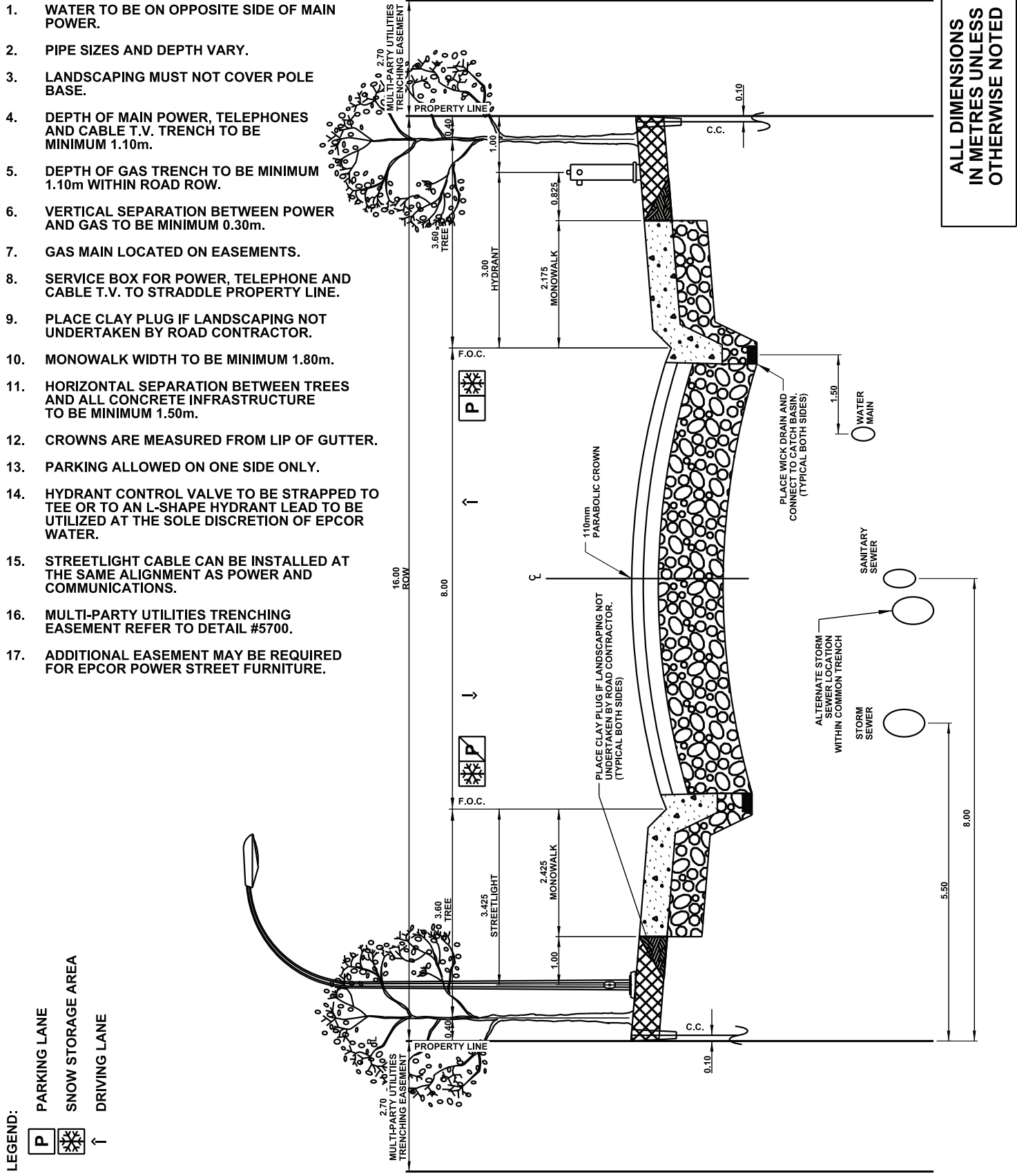

STANDARD DRAWING

2023-06-21

**8.00m URBAN LOCAL RESIDENTIAL (MONOWALK BOTH SIDES) - 16.00m ROW**

DATE APPROVED: **2018**

SCALE: **N.T.S.**

DRAWN BY: **KSYC**

CHECKED BY: **JN**

APPROVED: *M.R.*

DRAWING NUMBER: **2120**







NOTES:

1. CONSIDER SPEED AND VOLUME MANAGEMENT MEASURES TO ENHANCE COMFORT LEVEL FOR CYCLISTS.
2. SHARROW MARKINGS APPLIED TO BIKE NETWORK STREETS ONLY.
3. WATER TO BE ON OPPOSITE SIDE OF MAIN POWER LINE.
4. PIPE SIZES AND DEPTHS MAY VARY.
5. LANDSCAPING MUST NOT COVER POLE BASE.
6. DEPTH OF MAIN POWER, TELEPHONES AND CABLE T.V. TRENCH TO BE A MINIMUM 1.10m
7. DEPTH OF GAS TRENCH TO BE MINIMUM 1.10m WITHIN ROAD ROW.
8. REQUIRE A MINIMUM OF 0.30m VERTICAL SEPARATION BETWEEN POWER AND GAS
9. MINIMUM OF 1.00m SEPARATION BETWEEN BACK OF WALK AND POWER.
10. GAS MAIN LOCATED ON EASEMENT.
11. SERVICE BOX FOR POWER, TELEPHONE AND CABLE T.V. TO STRADDLE PROPERTY LINE.
12. PLACE CLAY PLUG IF LANDSCAPING NOT UNDERTAKEN BY ROAD CONTRACTOR.
13. CROWNS ARE MEASURED FROM LIP OF GUTTER.
14. EASEMENT PROVIDED AS REQUIRED.
15. SURFACE DRAINAGE TO CONFORM TO THE DRAINAGE BYLAW.
16. HYDRANT VALVE TO MEET EPCOR WATER MINIMUM SEPERATION REQUIREMENT. WATER VALVE TO BE STRAPPED TO TEE IF CONFLICTING WITH SIDEWALK INFRASTRUCTURE.
17. STREETLIGHT CABLE CAN BE INSTALLED AT THE SAME ALIGNMENT AS POWER AND COMMUNICATIONS.
18. MULTI-PARTY UTILITIES TRENCHING EASEMENT REFER TO DETAIL #5700.
19. ADDITIONAL EASEMENT MAY BE REQUIRED FOR EPCOR POWER STREET FURNITURE.

LEGEND:

-  SNOW STORAGE AREA
-  DRIVING LANE
-  SHARROW MARKINGS
-  PARKING

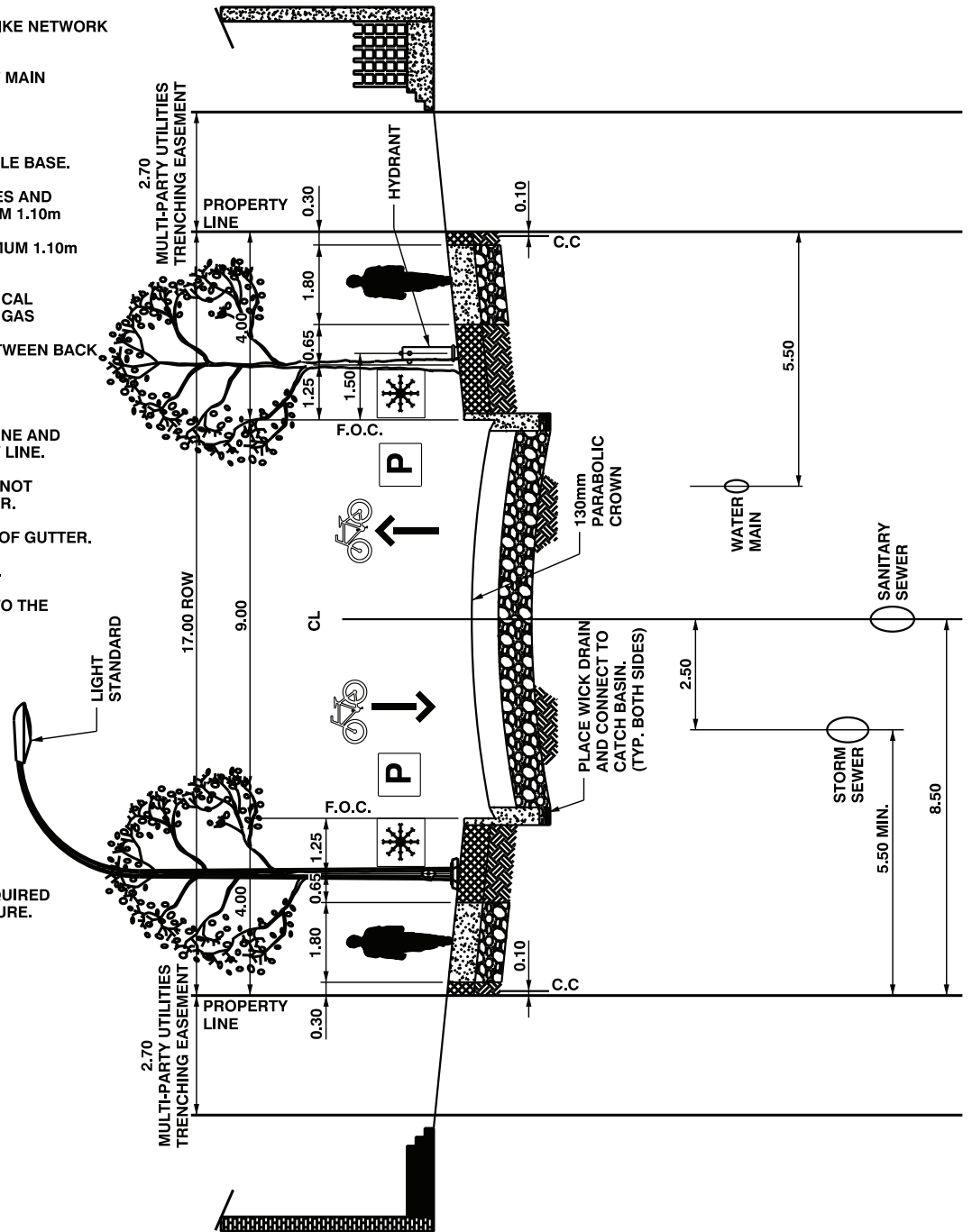

9.00m STREET ORIENTED RESIDENTIAL LOCAL  
(ON BIKE NETWORK / NOT ON BIKE NETWORK) - 17.00m ROW



STANDARD DRAWING

DATE APPROVED:

2018

DRAWN BY:

KSYC

APPROVED:

*M.R.*

DRAWING NUMBER:

2210

SCALE:

N.T.S.

CHECKED BY:

JN

NOTES:

1. WATER TO BE ON OPPOSITE SIDE OF MAIN POWER.
2. PIPE SIZES AND DEPTH VARY.
3. LANDSCAPING MUST NOT COVER POLE BASE.
4. DEPTH OF MAIN POWER, TELEPHONES AND CABLE T.V. TRENCH TO BE MINIMUM 1.10m.
5. DEPTH OF GAS TRENCH TO BE MINIMUM 1.10m WITHIN ROAD ROW.
6. VERTICAL SEPARATION BETWEEN POWER AND GAS TO BE MINIMUM 0.30m.
7. SEPARATION BETWEEN BACK OF WALK AND POWER TO BE MINIMUM 1.00m.
8. GAS MAIN LOCATED ON EASEMENTS.
9. SERVICE BOX FOR POWER, TELEPHONE AND CABLE T.V. TO STRADDLE PROPERTY LINE.
10. PLACE CLAY PLUG IF LANDSCAPING NOT UNDERTAKEN BY ROAD CONTRACTOR.
11. TREE OFFSET SAME ALIGNMENT AS STREETLIGHT WHERE APPLICABLE.
12. MONOWALK WIDTH TO BE MINIMUM 1.80m.
13. CROWNS ARE MEASURED FROM LIP OF GUTTER.
14. MONOWALK ON COLLECTOR ROADWAYS REQUIRES SPECIAL PERMISSION. (TYPICALLY NO MONOWALK ON NEW COLLECTORS)
15. HYDRANT CONTROL VALVE TO BE STRAPPED TO TEE OR TO AN L-SHAPE HYDRANT LEAD TO BE UTILIZED AT THE SOLE DISCRETION OF EPCOR WATER.
16. STREETLIGHT CABLE CAN BE INSTALLED AT THE SAME ALIGNMENT AS POWER AND COMMUNICATIONS.
17. MULTI-PARTY UTILITIES TRENCHING EASEMENT REFER TO DETAIL #5700.

ALL DIMENSIONS IN METRES UNLESS OTHERWISE NOTED

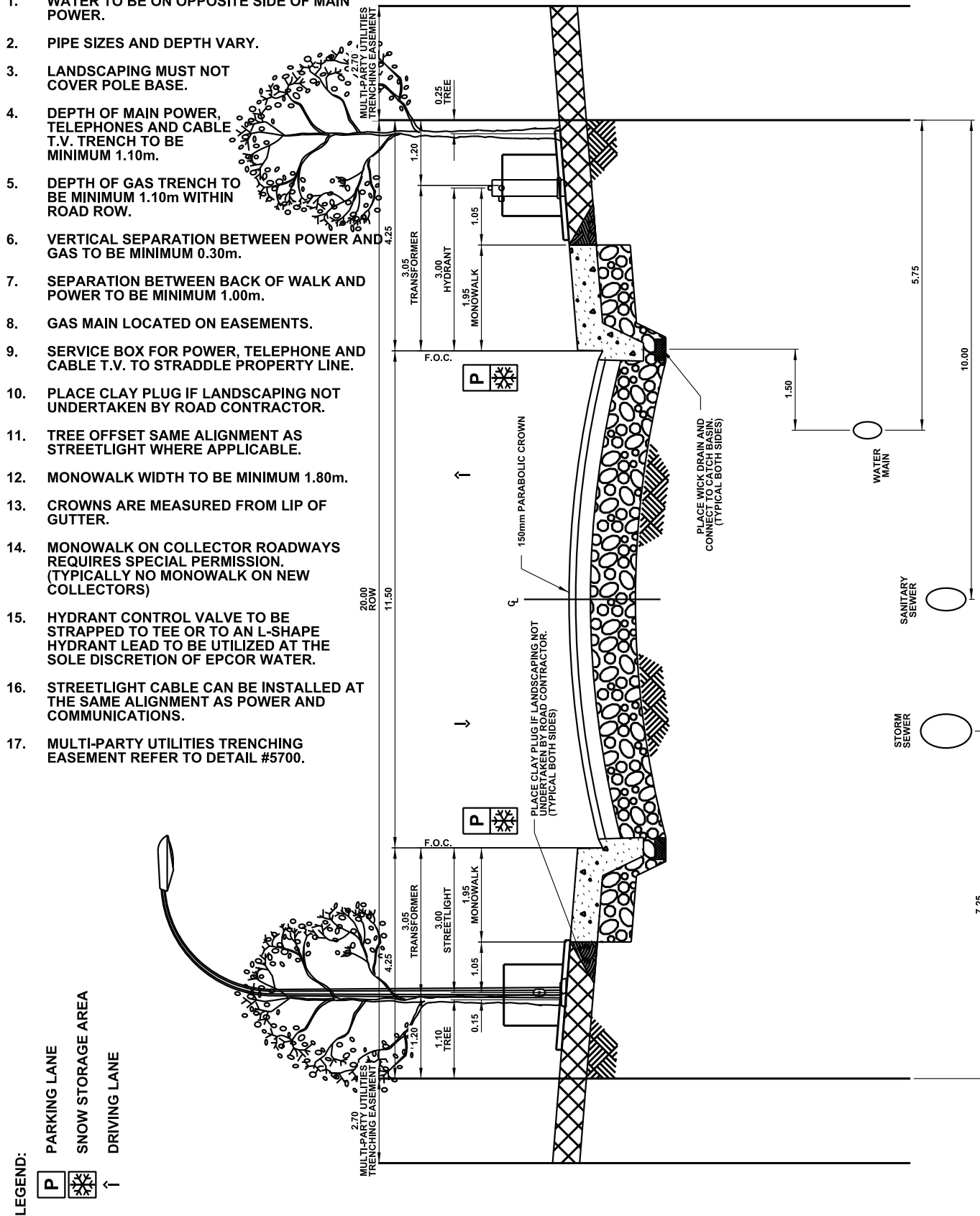

LEGEND:

- PARKING LANE
- SNOW STORAGE AREA
- DRIVING LANE

STANDARD DRAWING

2023-08-31

**11.50m INDUSTRIAL LOCAL (MONOWALK) - 20.00m ROW**

DATE APPROVED: **2018**

SCALE: **N.T.S.**

DRAWN BY: **KSYC**

CHECKED BY: **JN**

APPROVED:

DRAWING NUMBER: **2300**

NOTES:

1. WATER TO BE ON OPPOSITE SIDE OF MAIN POWER.
2. PIPE SIZES AND DEPTH VARY.
3. LANDSCAPING MUST NOT COVER POLE BASE.
4. DEPTH OF MAIN POWER, TELEPHONES AND CABLE T.V. TRENCH TO BE MINIMUM 1.10m.
5. DEPTH OF GAS TRENCH TO BE MINIMUM 1.10m WITHIN ROAD ROW.
6. VERTICAL SEPARATION BETWEEN POWER AND GAS TO BE MINIMUM 0.30m.
7. SEPARATION BETWEEN BACK OF WALK AND POWER TO BE MINIMUM 1.00m.
8. GAS MAIN LOCATED ON EASEMENTS.
9. SERVICE BOX FOR POWER, TELEPHONE AND CABLE T.V. TO STRADDLE PROPERTY LINE.
10. PLACE CLAY PLUG IF LANDSCAPING NOT UNDERTAKEN BY ROAD CONTRACTOR.
11. 11.50m RESIDENTIAL COLLECTOR TO HAVE SIDEWALK ON BOTH SIDES UNLESS OTHERWISE SPECIFIED.
12. 11.50m INDUSTRIAL LOCAL TO HAVE WALK ON ONE SIDE IF DESIGNATED BUS ROUTE.
13. CROWNS ARE MEASURED FROM LIP OF GUTTER.
14. HYDRANT CONTROL VALVE TO BE STRAPPED TO TEE OR TO AN L-SHAPE HYDRANT LEAD TO BE UTILIZED AT THE SOLE DISCRETION OF EPCOR WATER.
15. STREETLIGHT CABLE CAN BE INSTALLED AT THE SAME ALIGNMENT AS POWER AND COMMUNICATIONS.
16. MULTI-PARTY UTILITIES TRENCHING EASEMENT REFER TO DETAIL #5700.

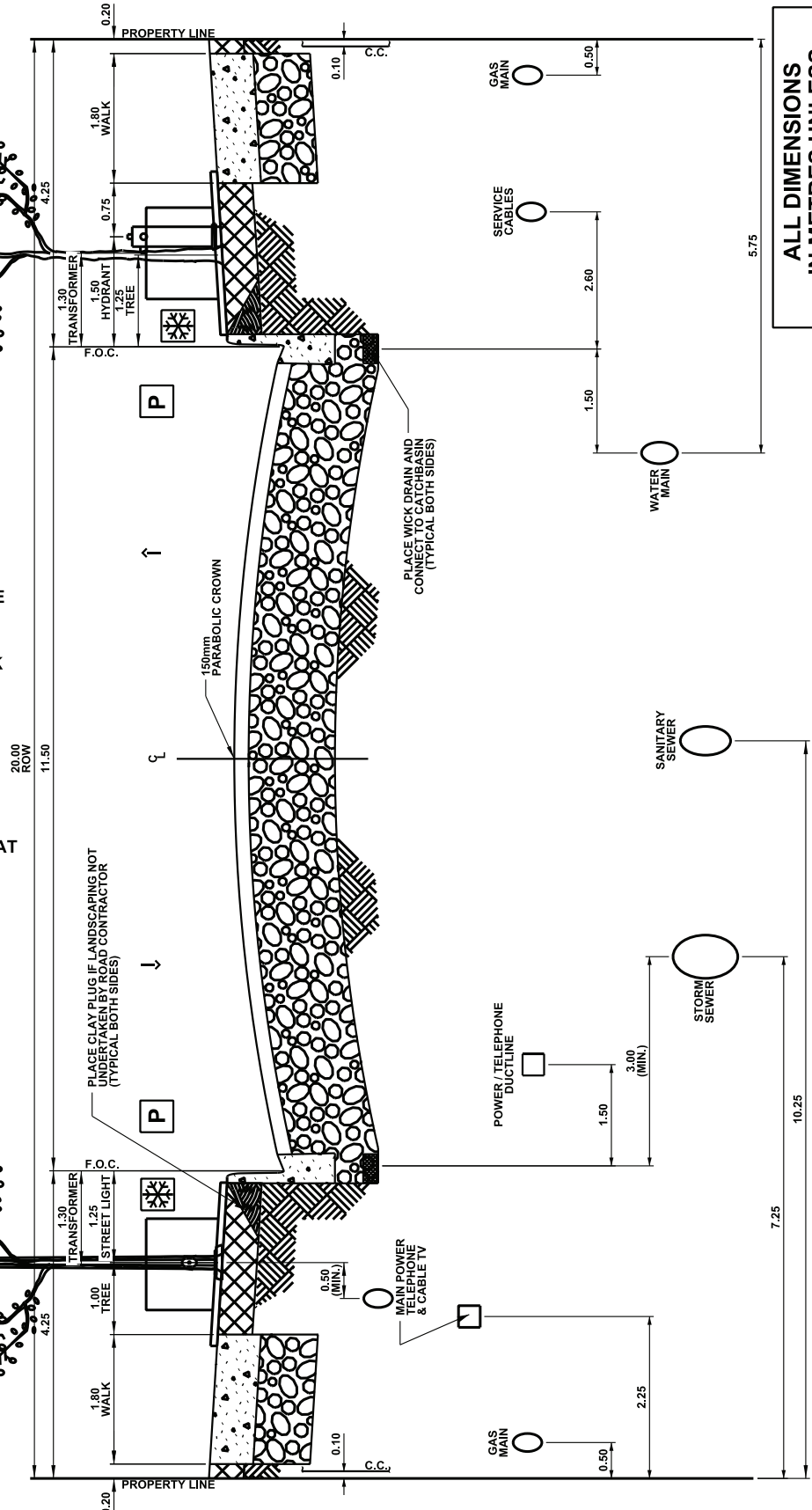

ALL DIMENSIONS IN METRES UNLESS OTHERWISE NOTED

**LEGEND:**

- P PARKING LANE
- SNOW STORAGE AREA
- DRIVING LANE



STANDARD DRAWING

2023-08-31

**11.50m INDUSTRIAL LOCAL (BOULEVARD WALK) - 20.00m ROW**

DATE APPROVED: **2018**

SCALE: **N.T.S.**

DRAWN BY: **KSYC**

CHECKED BY: **JN**



APPROVED: 

DRAWING NUMBER: **2310**

NOTES:

1. WATER TO BE ON OPPOSITE SIDE OF MAIN POWER.
2. PIPE SIZES AND DEPTH VARIES.
3. LANDSCAPING MUST NOT COVER POLE BASE.
4. DEPTH OF MAIN POWER, TELEPHONES AND CABLE T.V. TRENCH TO BE MINIMUM 1.10m.
5. DEPTH OF GAS TRENCH TO BE MINIMUM 1.10m WITHIN ROAD ROW.
6. REQUIRE A MINIMUM OF 0.30m VERTICAL SEPARATION BETWEEN POWER AND GAS.
7. MINIMUM OF 1.00m SEPARATION BETWEEN BACK OF WALK AND POWER.
8. GAS MAIN LOCATED ON EASEMENT.
9. SERVICE BOX FOR POWER, TELEPHONE AND CABLE T.V. TO STRADDLE PROPERTY LINE.
10. PLACE CLAY PLUG IF LANDSCAPING NOT UNDERTAKEN BY ROAD CONTRACTOR.
11. CROWNS ARE MEASURED FROM LIP OF GUTTER.
12. EASEMENT PROVIDED AS REQUIRED.
13. SURFACE DRAINAGE TO CONFORM TO THE DRAINAGE BYLAW.
14. HYDRANT VALVE TO MEET EPCOR WATER MINIMUM SEPERATION REQUIREMENT. WATER VALVE TO BE STRAPPED TO TEE IF CONFLICTING WITH SIDEWALK INFRASTRUCTURE.
15. STREETLIGHT CABLE CAN BE INSTALLED AT THE SAME ALIGNMENT AS POWER AND COMMUNICATIONS.
16. MULTI-PARTY UTILITIES TRENCHING EASEMENT REFER TO DETAIL #5700.

LEGEND:

-  SNOW STORAGE AREA
-  PARKING
-  DRIVING LANE

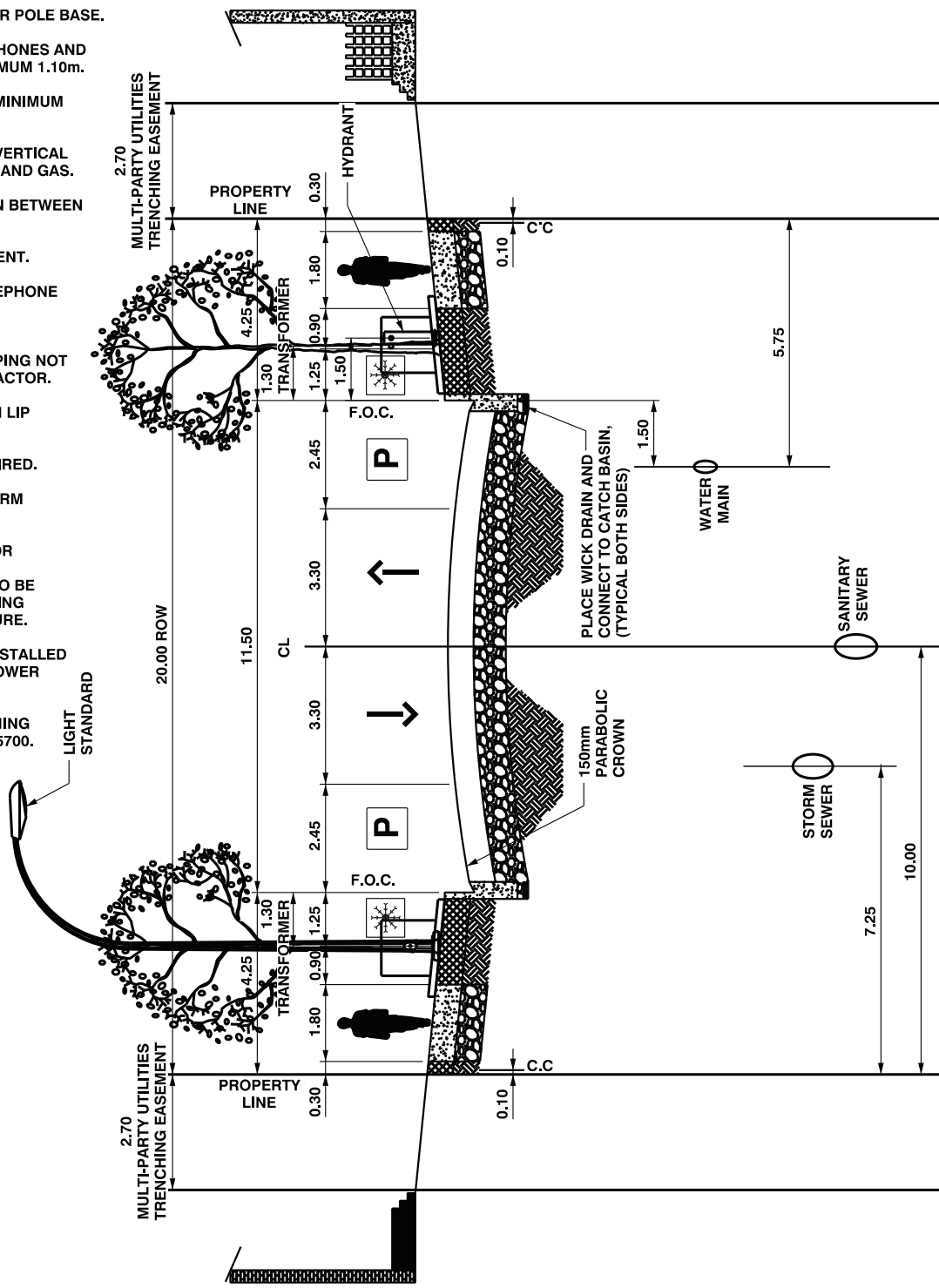

11.50m STREET ORIENTED RESIDENTIAL COLLECTOR (NOT ON BIKE NETWORK) - 20.00m ROW



STANDARD DRAWING

DATE APPROVED:

2018

DRAWN BY:

KSYC

APPROVED:

*M.R.*

DRAWING NUMBER:

2320

SCALE:

N.T.S.

CHECKED BY:

JN













NOTES:

1. REFER TO COMPLETE STREET GUIDELINE FOR INTERSECTION DESIGN TO PRIORITIZE CYCLE TRACK USE.
2. IT MAY BE DESIRABLE TO LIMIT PARKING WHERE APPROPRIATE.
3. LIMIT CONFLICT POINTS AT CYCLE TRACK. FRONT DRIVE ACCESS NOT PERMITTED ON SAME SIDE AS CYCLE TRACK.
4. WATER TO BE ON OPPOSITE SIDE OF MAIN POWER LINE.
5. PIPE SIZES AND DEPTHS MAY VARY.
6. LANDSCAPING MUST NOT COVER POLE BASE.
7. DEPTH OF MAIN POWER, TELEPHONES AND CABLE T.V. TRENCH TO BE A MINIMUM 1.10m.
8. DEPTH OF GAS TRENCH TO BE MINIMUM 1.10m WITHIN ROAD ROW.
9. REQUIRE A MINIMUM OF 0.30m VERTICAL SEPARATION BETWEEN POWER AND GAS.
10. MINIMUM OF 1.00m SEPARATION BETWEEN BACK OF WALK AND POWER.
11. SERVICE BOX FOR POWER, TELEPHONE AND CABLE T.V. TO STRADDLE PROPERTY LINE.
12. PLACE CLAY PLUG IF LANDSCAPING NOT UNDERTAKEN BY ROAD CONTRACTOR.
13. EASEMENT PROVIDED AS REQUIRED.
14. SURFACE DRAINAGE TO CONFORM TO THE DRAINAGE BYLAW.
15. CYCLE TRACK AND SIDEWALK MUST BE SEPARATED USING DIFFERENT MATERIAL TEXTURES.
16. HYDRANT CONTROL VALVE TO BE STRAPPED TO TEE OR TO AN L-SHAPE HYDRANT LEAD TO BE UTILIZED AT THE SOLE DISCRETION OF EPCOR WATER.
17. STREETLIGHT CABLE CAN BE INSTALLED AT THE SAME ALIGNMENT AS POWER AND COMMUNICATIONS.
18. MULTI-PARTY UTILITIES TRENCHING EASEMENT REFER TO DETAIL #5700.

LEGEND:

-  SNOW STORAGE AREA
-  DRIVING LANE
-  PARKING

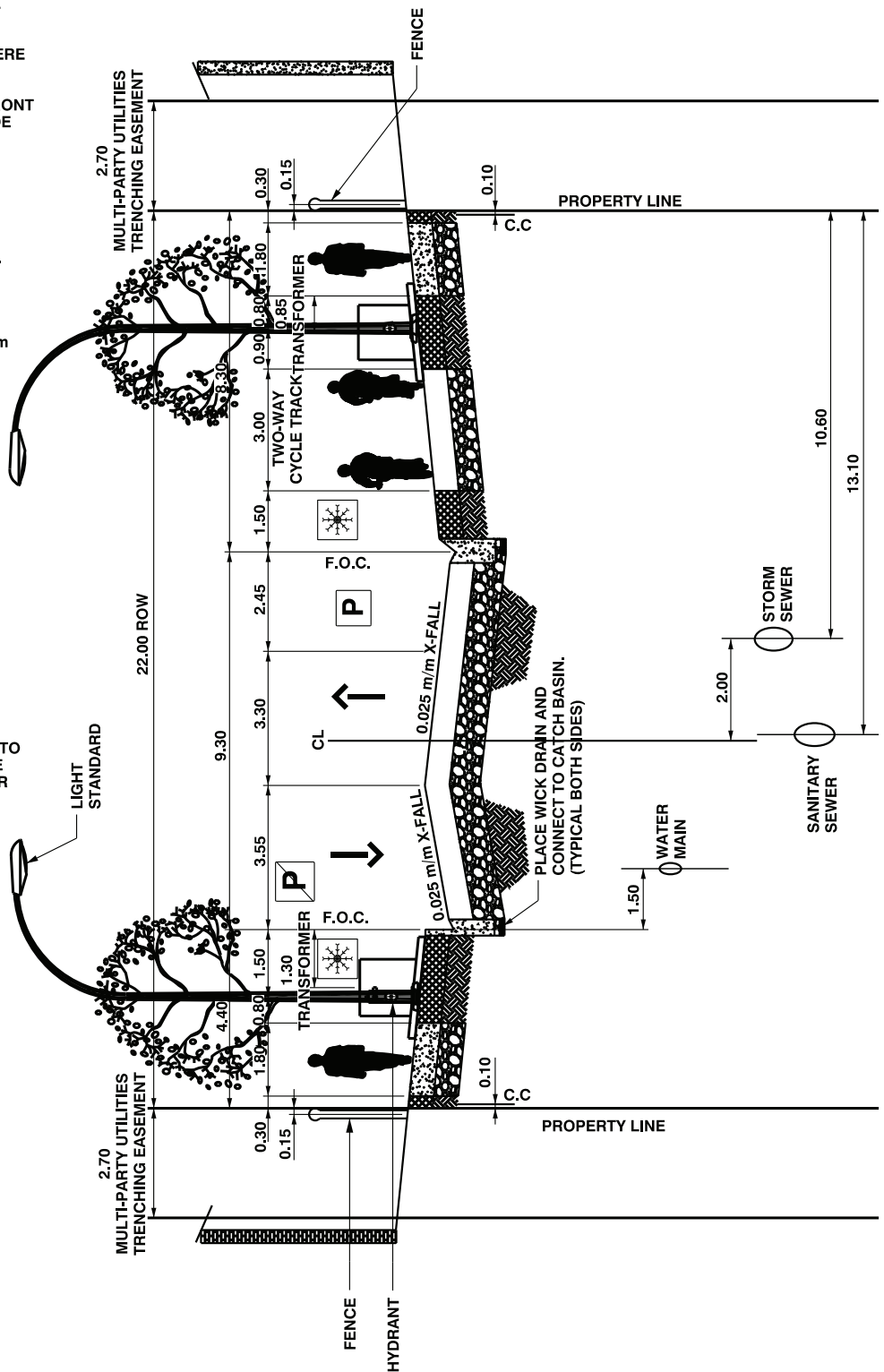

9.30m NON-STREET ORIENTED RESIDENTIAL OR COMMERCIAL / MIXED USE COLLECTOR (ON BIKE NETWORK) - 22.00m ROW



STANDARD DRAWING

2023-08-31

DATE APPROVED:

2018

DRAWN BY:

KSYC

APPROVED:

*M.L.R.*

DRAWING NUMBER:

2325

SCALE:

N.T.S.

CHECKED BY:

JN

v05



Page 529



NOTES:

1. REFER TO COMPLETE STREETS GUIDELINES FOR INTERSECTION DESIGN TO PRIORITIZE SHARED-USE USERS.
2. IT MAY BE DESIRABLE TO LIMIT PARKING WHERE APPROPRIATE.
3. LIMIT CONFLICT POINTS AT SHARED-USE PATH. FRONT DRIVES NOT PERMITTED ON THE SAME SIDE AS THE SHARED-USED PATH.
4. WATER TO BE ON OPPOSITE SIDE OF MAIN POWER LINE.
5. PIPE SIZES AND DEPTHS MAY VARY.
6. LANDSCAPING MUST NOT COVER POLE BASE.
7. DEPTH OF MAIN POWER, TELEPHONES AND CABLE T.V. TRENCH TO BE A MINIMUM 1.10m.
8. DEPTH OF GAS TRENCH TO BE MINIMUM 1.10m WITHIN ROAD ROW.
9. REQUIRE A MINIMUM OF 0.30m VERTICAL SEPARATION BETWEEN POWER AND GAS.
10. MINIMUM OF 1.00m SEPARATION BETWEEN BACK OF WALK AND POWER.
11. GAS MAIN LOCATED ON EASEMENT.
12. SERVICE BOX FOR POWER, TELEPHONE AND CABLE T.V. TO STRADDLE PROPERTY LINE.
13. PLACE CLAY PLUG IF LANDSCAPING NOT UNDERTAKEN BY ROAD CONTRACTOR.
14. CROWNS ARE MEASURED FROM LIP OF GUTTER.
15. HYDRANT CONTROL VALVE TO BE STRAPPED TO TEE OR TO AN L-SHAPE HYDRANT LEAD TO BE UTILIZED AT THE SOLE DISCRETION OF EPCOR WATER.
16. STREETLIGHT CABLE CAN BE INSTALLED AT THE SAME ALIGNMENT AS POWER AND COMMUNICATIONS.
17. EASEMENT PROVIDED AS REQUIRED.
18. SURFACE DRAINAGE TO CONFORM TO THE DRAINAGE BYLAW.
19. HYDRANT VALVE TO MEET EPCOR WATER MINIMUM SEPERATION REQUIREMENT. WATER VALVE TO BE STRAPPED TO TEE IF CONFLICTING WITH SIDEWALK INFRASTRUCTURE.
20. MULTI-PARTY UTILITIES TRENCHING EASEMENT REFER TO DETAIL #5700.

LEGEND:

-  SNOW STORAGE AREA
-  PARKING
-  DRIVING LANE

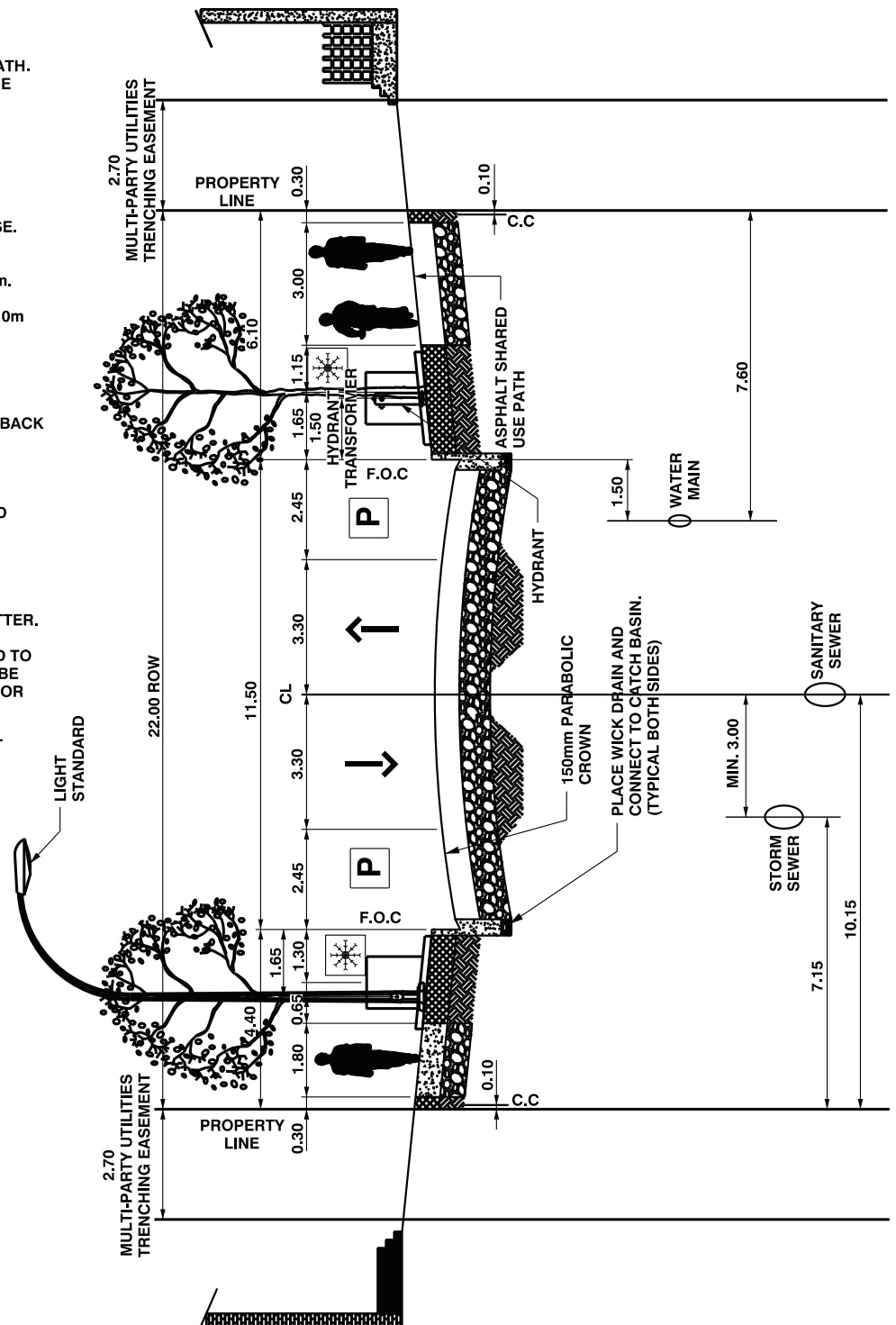

11.50m STREET ORIENTED RESIDENTIAL COLLECTOR (ON BIKE NETWORK) - 22.00m ROW



STANDARD DRAWING

2023-08-31

DATE APPROVED: 2018

SCALE: N.T.S.

DRAWN BY: KSYC

CHECKED BY: JN

APPROVED: *M.L.R.*

DRAWING NUMBER: 2327



Page 531

v05

NOTES:

1. REFER TO COMPLETE STREETS GUIDELINES FOR INTERSECTION DESIGN TO PRIORITIZE SHARED-USE USERS.
2. IT MAY BE DESIRABLE TO LIMIT PARKING WHERE APPROPRIATE.
3. LIMIT CONFLICT POINTS AT SHARED-USE PATH. FRONT DRIVES NOT PERMITTED ON THE SAME SIDE AS THE SHARED-USED PATH.
4. WATER TO BE ON OPPOSITE SIDE OF MAIN POWER LINE.
5. PIPE SIZES AND DEPTHS MAY VARY.
6. LANDSCAPING MUST NOT COVER POLE BASE.
7. DEPTH OF MAIN POWER, TELEPHONES AND CABLE T.V. TRENCH TO BE A MINIMUM 1.10m.
8. DEPTH OF GAS TRENCH TO BE MINIMUM 1.10m WITHIN ROAD ROW.
9. REQUIRE A MINIMUM OF 0.30m VERTICAL SEPARATION BETWEEN POWER AND GAS.
10. MINIMUM OF 1.00m SEPARATION BETWEEN BACK OF WALK AND POWER.
11. GAS MAIN LOCATED ON EASEMENT.
12. SERVICE BOX FOR POWER, TELEPHONE AND CABLE T.V. TO STRADDLE PROPERTY LINE.
13. PLACE CLAY PLUG IF LANDSCAPING NOT UNDERTAKEN BY ROAD CONTRACTOR.
14. CROWNS ARE MEASURED FROM LIP OF GUTTER.
15. HYDRANT CONTROL VALVE TO BE STRAPPED TO TEE OR TO AN L-SHAPE HYDRANT LEAD TO BE UTILIZED AT THE SOLE DISCRETION OF EPCOR WATER.
16. STREETLIGHT CABLE CAN BE INSTALLED AT THE SAME ALIGNMENT AS POWER AND COMMUNICATIONS.
17. EASEMENT PROVIDED AS REQUIRED.
18. SURFACE DRAINAGE TO CONFORM TO THE DRAINAGE BYLAW.
19. HYDRANT VALVE TO MEET EPCOR WATER MINIMUM SEPERATION REQUIREMENT. WATER VALVE TO BE STRAPPED TO TEE IF CONFLICTING WITH SIDEWALK INFRASTRUCTURE.
20. MULTI-PARTY UTILITIES TRENCHING EASEMENT REFER TO DETAIL #5700.
21. ADDITIONAL EASEMENT MAY BE REQUIRED FOR EPCOR POWER STREET FURNITURE.

LEGEND:

-  SNOW STORAGE AREA
-  PARKING
-  DRIVING LANE

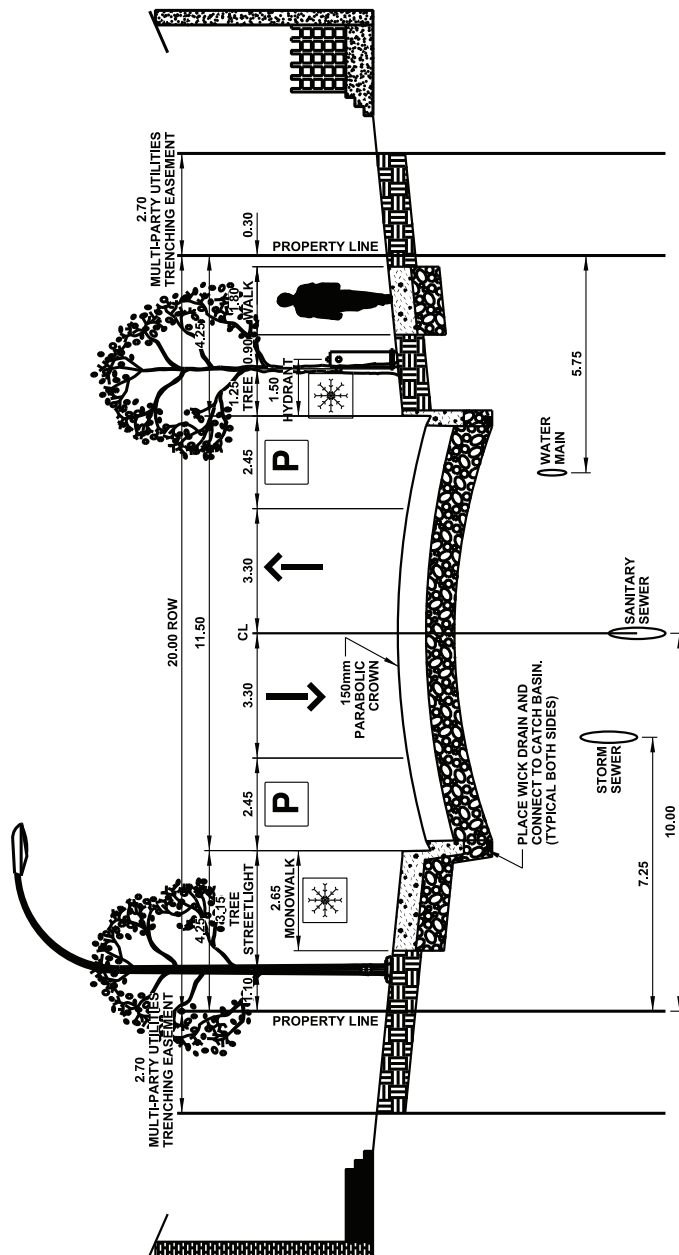

ALL DIMENSIONS IN METRES UNLESS OTHERWISE NOTED



STANDARD DRAWING

11.50m SCHOOL SITE COLLECTOR (NOT ON BIKE NETWORK) - 20.00m ROW

DATE APPROVED: 2018  
SCALE: N.T.S.

DRAWN BY: KSYC  
CHECKED BY: JN

APPROVED: *M.A.R.*



DRAWING NUMBER: 2328



NOTES:

1. WATER TO BE ON OPPOSITE SIDE OF MAIN POWER LINE.
2. PIPE SIZES AND DEPTHS MAY VARY.
3. LANDSCAPING MUST NOT COVER POLE BASE.
4. DEPTH OF MAIN POWER, TELEPHONES AND CABLE T.V. TRENCH TO BE A MINIMUM 1.10m.
5. DEPTH OF GAS TRENCH TO BE MINIMUM 1.10m WITHIN ROAD ROW.
6. REQUIRE A MINIMUM OF 0.30m VERTICAL SEPARATION BETWEEN POWER AND GAS
7. MINIMUM OF 1.00m SEPARATION BETWEEN BACK OF WALK AND POWER.
8. GAS MAIN LOCATED ON EASEMENT.
9. SERVICE BOX FOR POWER, TELEPHONE AND CABLE T.V. TO STRADDLE PROPERTY LINE.
10. PLACE CLAY PLUG IF LANDSCAPING NOT UNDERTAKEN BY ROAD CONTRACTOR.
11. CROWNS ARE MEASURED FROM LIP OF GUTTER.
12. EASEMENT PROVIDED AS REQUIRED.
13. SURFACE DRAINAGE TO CONFORM TO THE DRAINAGE BYLAW.
14. HYDRANT CONTROL VALVE TO BE STRAPPED TO TEE OR TO AN L-SHAPE HYDRANT LEAD TO BE UTILIZED AT THE SOLE DISCRETION OF EPCOR WATER.
15. STREETLIGHT CABLE CAN BE INSTALLED AT THE SAME ALIGNMENT AS POWER AND COMMUNICATIONS.
16. MULTI-PARTY UTILITIES TRENCHING EASEMENT REFER TO DETAIL #5700.

LEGEND:

-  SNOW STORAGE AREA
-  DRIVING LANE
-  BUFFERED BIKE LANE
-  PARKING

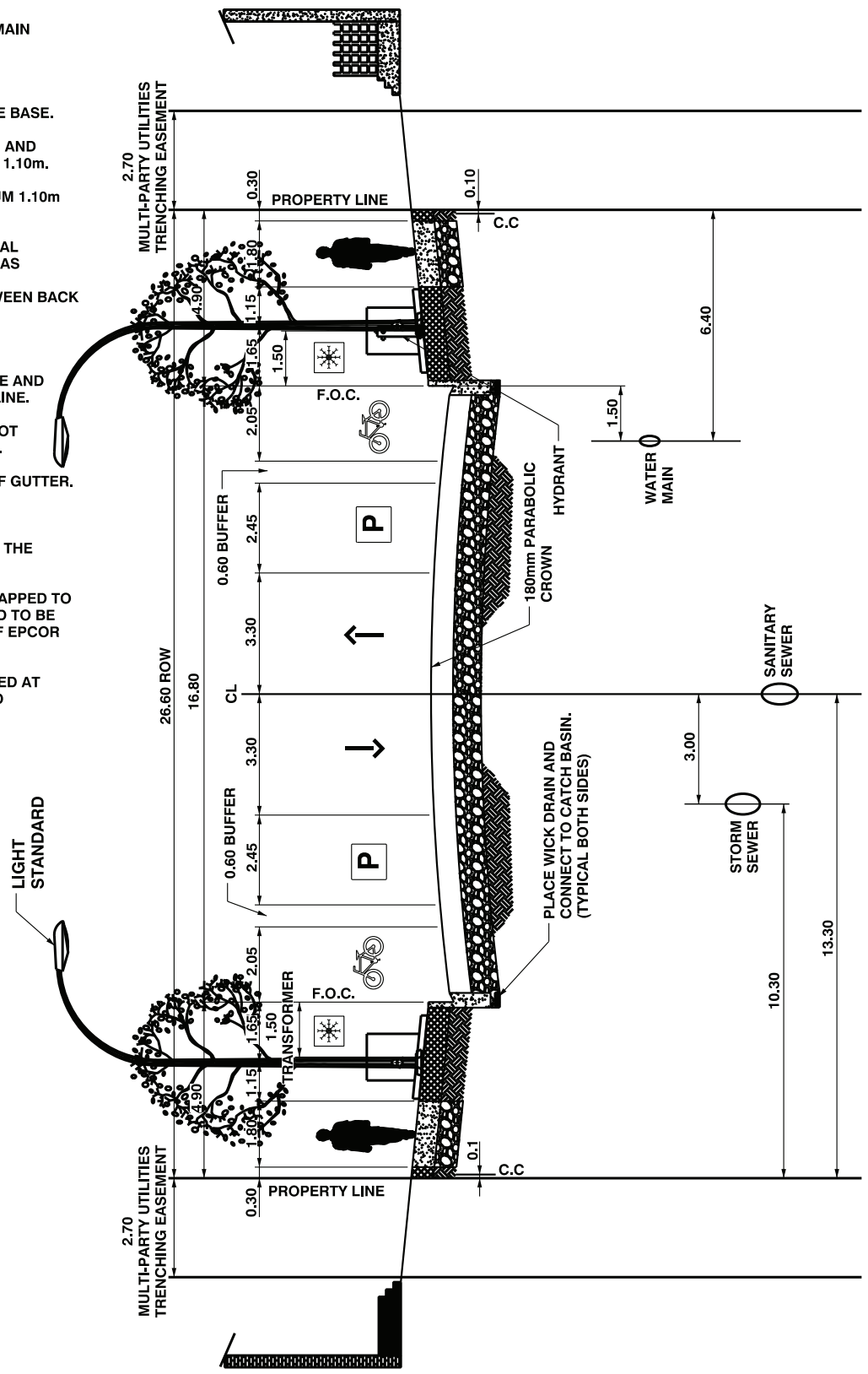

STANDARD DRAWING

2023-08-31

16.80m STREET ORIENTED COMMERCIAL MIXED-USE COLLECTOR (ON BIKE NETWORK) - 26.60m ROW

DATE APPROVED: 2018

SCALE: N.T.S.

DRAWN BY: KSYC

CHECKED BY: JN

APPROVED: *M.R.*

DRAWING NUMBER: 2342

v05

Page 534

**ALL DIMENSIONS IN METRES UNLESS OTHERWISE NOTED**

**NOTES:**

1. WATER TO BE ON OPPOSITE SIDE OF MAIN POWER.
2. PIPE SIZES AND DEPTH VARY.
3. LANDSCAPING MUST NOT COVER POLE BASE.
4. DEPTH OF MAIN POWER, TELEPHONES AND CABLE T.V. TRENCH TO BE MINIMUM 1.10m.
5. DEPTH OF GAS TRENCH TO BE MINIMUM 1.10m WITHIN ROAD ROW.
6. VERTICAL SEPARATION BETWEEN POWER AND GAS TO BE MINIMUM 0.30m.
7. SEPARATION BETWEEN BACK OF WALK AND POWER TO BE MINIMUM 1.00m.
8. GAS MAIN LOCATED ON EASEMENTS.
9. SERVICE BOX FOR POWER, TELEPHONE AND CABLE T.V. TO STRADDLE PROPERTY LINE.
10. PLACE CLAY PLUG IF LANDSCAPING NOT UNDERTAKEN BY ROAD CONTRACTOR.
11. 13.70m URBAN COLLECTOR TO HAVE SIDEWALK ON BOTH SIDES UNLESS OTHERWISE SPECIFIED.
12. CROWNS ARE MEASURED FROM LIP OF GUTTER.
13. HYDRANT CONTROL VALVE TO BE STRAPPED TO TEE OR TO AN L-SHAPE HYDRANT LEAD TO BE UTILIZED AT THE SOLE DISCRETION OF EPCOR WATER.
14. STREETLIGHT CABLE CAN BE INSTALLED AT THE SAME ALIGNMENT AS POWER AND COMMUNICATIONS.
15. MULTI-PARTY UTILITIES TRENCHING EASEMENT REFER TO DETAIL #5700.

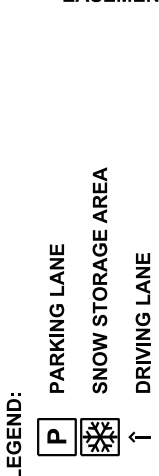

**LEGEND:**  
 P PARKING LANE  
 SNOW STORAGE AREA  
 DRIVING LANE



**13.70m URBAN COLLECTOR (BOULEVARD WALK) - 23.80m ROW**

DATE APPROVED: **2018**  
 SCALE: **N.T.S.**

DRAWN BY: **KSYC**  
 CHECKED BY: **JN**

APPROVED:

DRAWING NUMBER: **2410**

NOTES:

1. WATER TO BE ON OPPOSITE SIDE OF MAIN POWER.
2. PIPE SIZES AND DEPTH VARY.
3. LANDSCAPING MUST NOT COVER POLE BASE.
4. DEPTH OF MAIN POWER, TELEPHONES AND CABLE T.V. TRENCH TO BE MINIMUM 1.10m.
5. DEPTH OF GAS TRENCH TO BE MINIMUM 1.10m WITHIN ROAD ROW.
6. VERTICAL SEPARATION BETWEEN POWER AND GAS TO BE MINIMUM 0.30m.
7. SEPARATION BETWEEN BACK OF WALK AND POWER TO BE MINIMUM 1.00m.
8. GAS MAIN LOCATED ON EASEMENTS.
9. SERVICE BOX FOR POWER, TELEPHONE AND CABLE T.V. TO STRADDLE PROPERTY LINE.
10. PLACE CLAY PLUG IF LANDSCAPING NOT UNDERTAKEN BY ROAD CONTRACTOR.
11. 13.20m INDUSTRIAL COLLECTOR TO HAVE SHARED USE PATH ON ONE SIDE IF DESIGNATED BUS ROUTE.
12. CROWNS ARE MEASURED FROM LIP OF GUTTER.
13. HYDRANT CONTROL VALVE TO BE STRAPPED TO TEE OR TO AN L-SHAPE HYDRANT LEAD TO BE UTILIZED AT THE SOLE DISCRETION OF EPCOR WATER.
14. STREETLIGHT CABLE CAN BE INSTALLED AT THE SAME ALIGNMENT AS POWER AND COMMUNICATIONS.
15. MULTI-PARTY UTILITIES TRENCHING EASEMENT REFER TO DETAIL #5700.

LEGEND:

- PARKING LANE
- SNOW STORAGE AREA
- DRIVING LANE

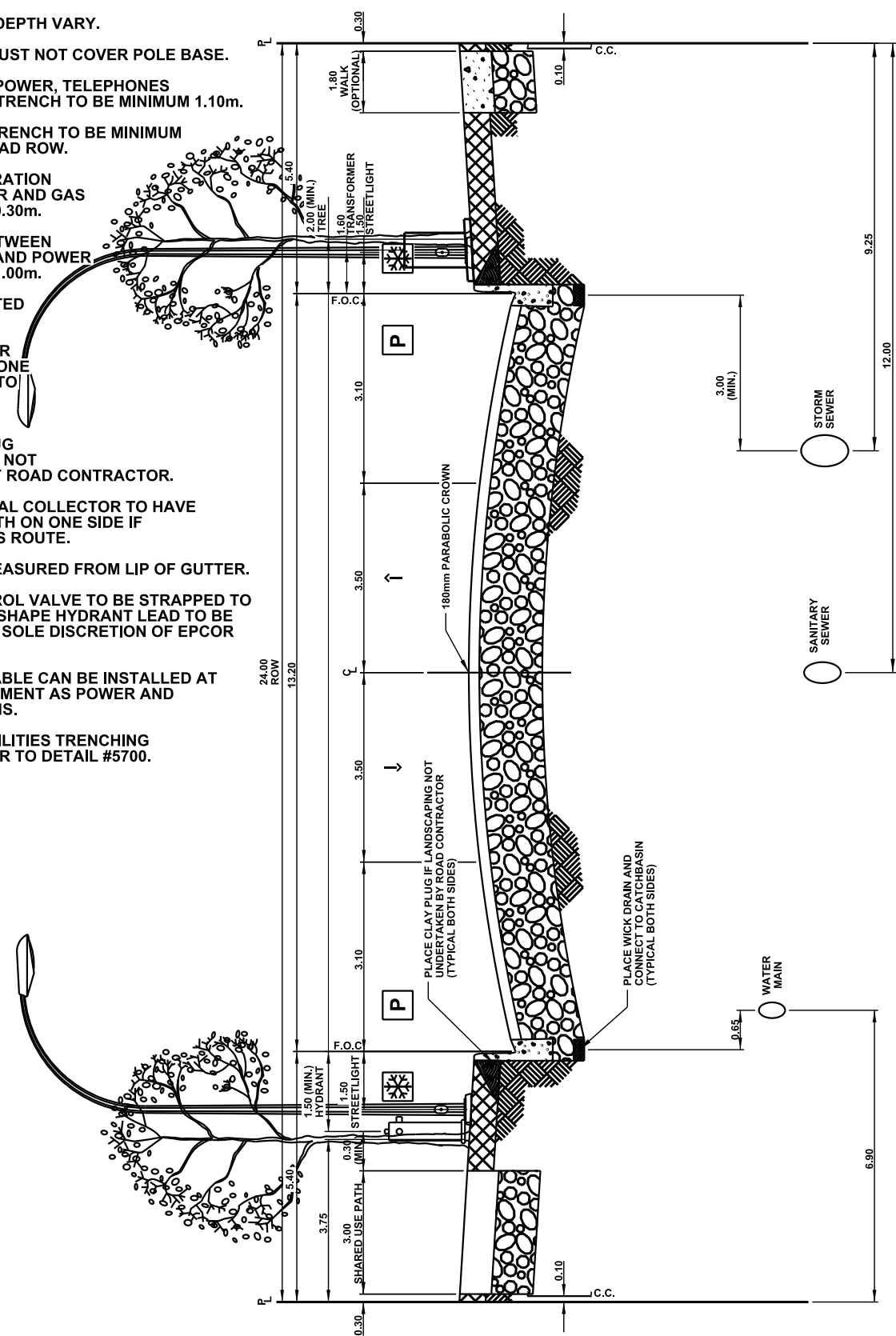

ALL DIMENSIONS IN METRES UNLESS OTHERWISE NOTED



**13.20m INDUSTRIAL COLLECTOR (SHARED USE PATH) - 24.00m ROW**

DATE APPROVED: **2018**  
SCALE: **N.T.S.**

DRAWN BY: **KSYC**  
CHECKED BY: **JN**

APPROVED: *M.R.*

DRAWING NUMBER: **2411**



NOTES:

1. WATER TO BE ON OPPOSITE SIDE OF MAIN POWER.
2. PIPE SIZES AND DEPTH VARIES.
3. LANDSCAPING MUST NOT COVER POLE BASE.
4. DEPTH OF MAIN POWER, TELEPHONES AND CABLE T.V. TRENCH TO BE MINIMUM 1.10m.
5. DEPTH OF GAS TRENCH TO BE MINIMUM 1.10m WITHIN ROAD ROW.
6. REQUIRE A MINIMUM OF 0.30m VERTICAL SEPARATION BETWEEN POWER AND GAS.
7. MINIMUM OF 1.00m SEPARATION BETWEEN BACK OF WALK AND POWER.
8. SERVICE BOX FOR POWER, TELEPHONE AND CABLE T.V. TO STRADDLE PROPERTY LINE.
9. INDUSTRIAL COLLECTOR TO HAVE SIDEWALK ON ONE SIDE OF DESIGNATED BUS ROUTE.
10. LID AND NATURALIZATION BMP'S TO BE EXPLORED FOR ALL DITCH APPLICATIONS.
11. HYDRANT CONTROL VALVE TO BE STRAPPED TO TEE OR TO AN L-SHAPE HYDRANT LEAD TO BE UTILIZED AT THE SOLE DISCRETION OF EPCOR WATER.
12. STREETLIGHT CABLE CAN BE INSTALLED AT THE SAME ALIGNMENT AS POWER AND COMMUNICATIONS.
13. MULTI-PARTY UTILITIES TRENCHING EASEMENT REFER TO DETAIL #5700.

LEGEND:

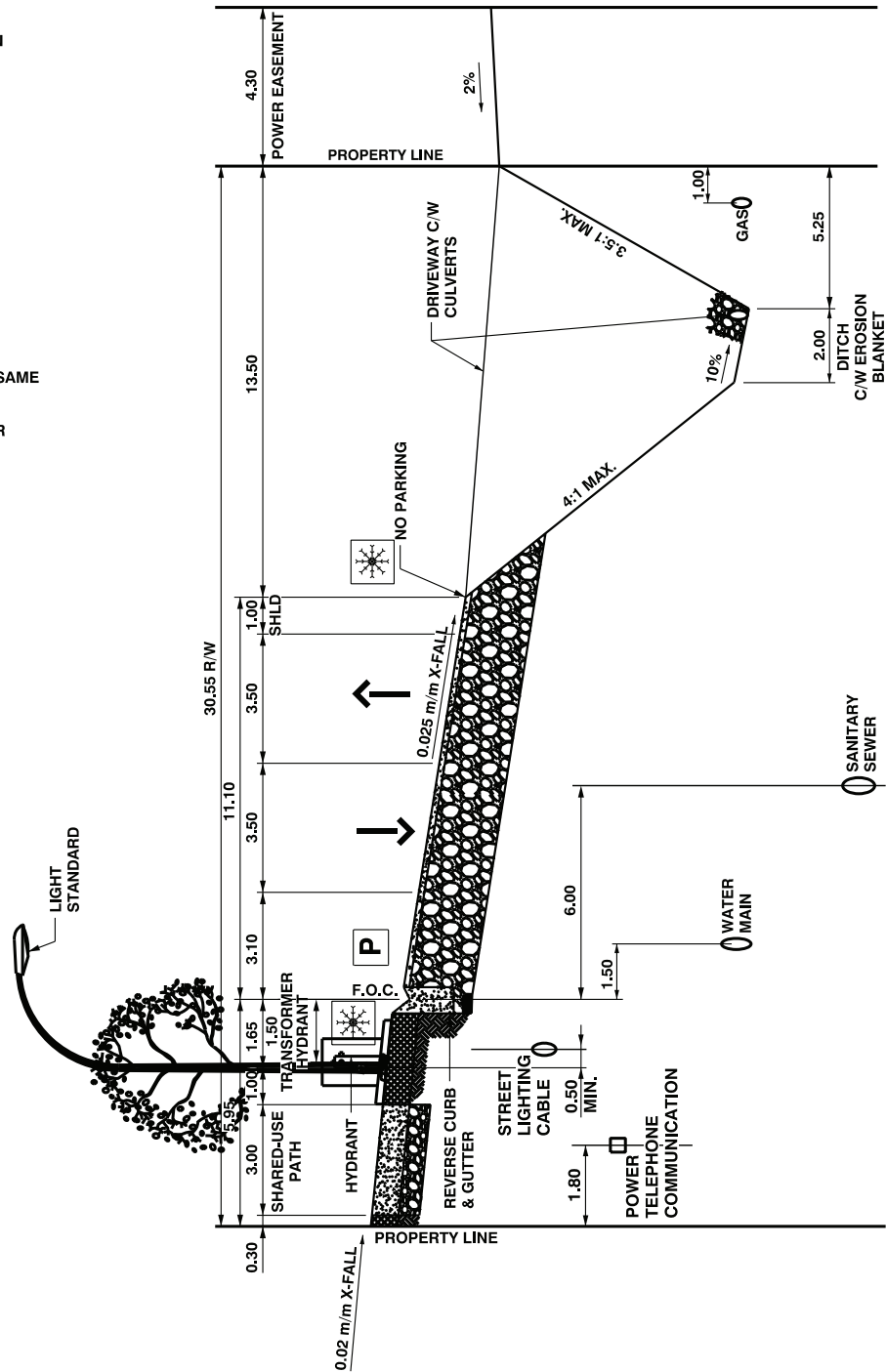

STANDARD DRAWING

11.10m HYBRID INDUSTRIAL COLLECTOR (BOULEVARD WALK) - 30.55m ROW

DATE APPROVED:

2018

DRAWN BY:

KSYC

APPROVED:

*M.R.*

DRAWING NUMBER:

2420

SCALE:

N.T.S.

CHECKED BY:

JN

NOTES:

1. WATER TO BE ON OPPOSITE SIDE OF MAIN POWER.
2. PIPE SIZES AND DEPTH VARIES.
3. LANDSCAPING MUST NOT COVER POLE BASE.
4. DEPTH OF MAIN POWER, TELEPHONES AND CABLE T.V. TRENCH TO BE MINIMUM 1.10m.
5. DEPTH OF GAS TRENCH TO BE MINIMUM 1.10m WITHIN ROAD ROW.
6. REQUIRE A MINIMUM OF 0.30m VERTICAL SEPERATION BETWEEN POWER AND GAS.
7. MINIMUM OF 1.00m SEPERATION BETWEEN BACK OF WALK AND POWER.
8. SERVICE BOX FOR POWER, TELEPHONE AND CABLE T.V. TO STRADDLE PROPERTY LINE.
9. LID AND NATURALIZATION BMP'S TO BE EXPLORED FOR ALL DITCH APPLICATIONS.
10. HYDRANT CONTROL VALVE TO BE STRAPPED TO TEE OR TO AN L-SHAPE HYDRANT LEAD TO BE UTILIZED AT THE SOLE DISCRETION OF EPCOR WATER.
11. STREETLIGHT CABLE CAN BE INSTALLED AT THE SAME ALIGNMENT AS POWER AND COMMUNICATIONS.
12. MULTI-PARTY UTILITIES TRENCHING EASEMENT REFER TO DETAIL #5700.

LEGEND:

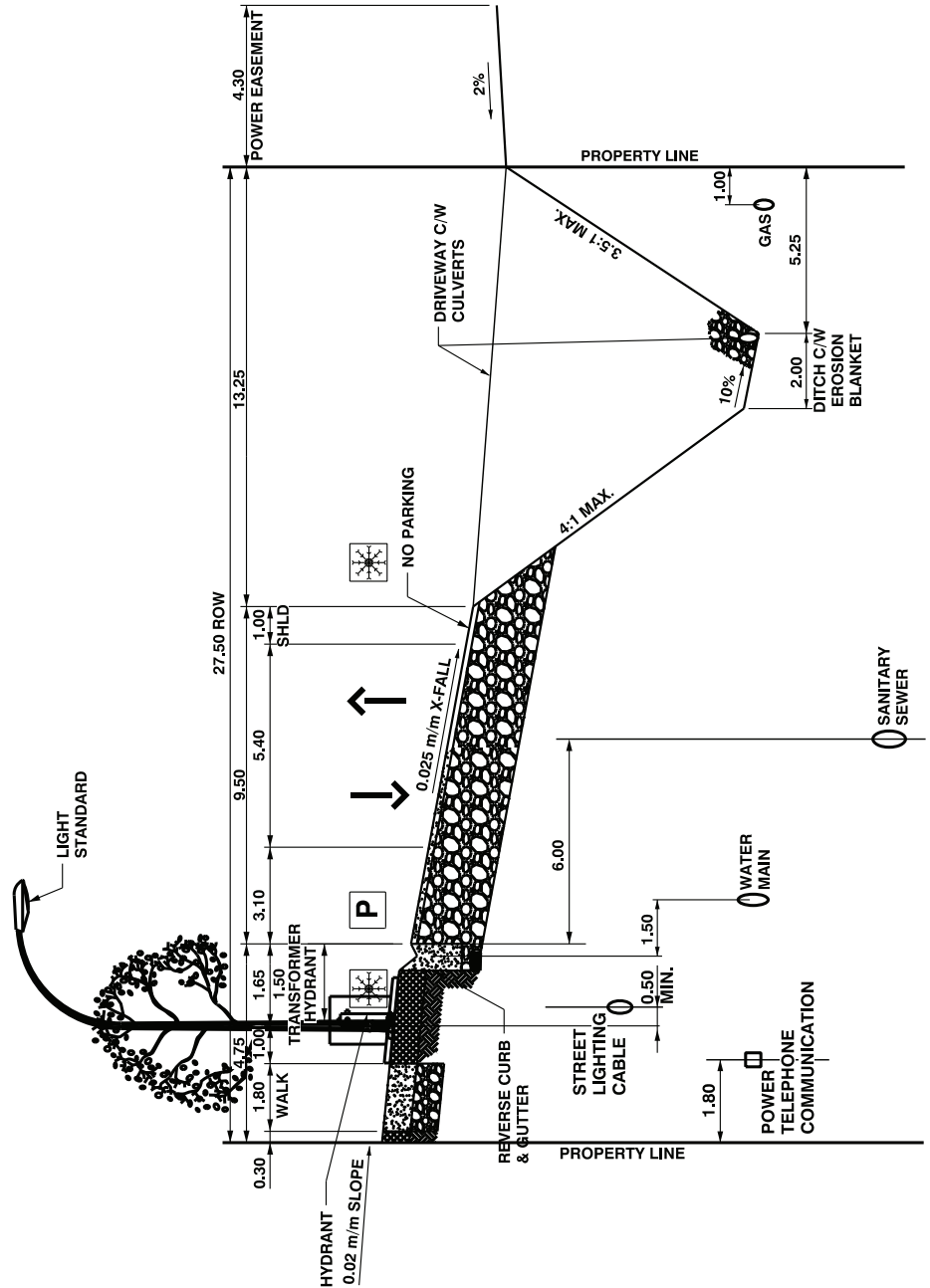

STANDARD DRAWING

2023-08-31

9.50m HYBRID INDUSTRIAL LOCAL (BOULEVARD WALK) - 27.50m ROW

DATE APPROVED:

2018

DRAWN BY:

KSYC

APPROVED:

DRAWING NUMBER:

2421

SCALE:

N.T.S.

CHECKED BY:

JN

v05

Page 538

NOTES:

1. WATER TO BE ON OPPOSITE SIDE OF MAIN POWER.
2. PIPE SIZES AND DEPTH VARIES.
3. LANDSCAPING MUST NOT COVER POLE BASE.
4. DEPTH OF MAIN POWER, TELEPHONES AND CABLE T.V. TRENCH TO BE MINIMUM 1.10m.
5. DEPTH OF GAS TRENCH TO BE MINIMUM 1.10m WITHIN ROAD ROW.
6. REQUIRE A MINIMUM OF 0.30m VERTICAL SEPARATION BETWEEN POWER AND GAS.
7. MINIMUM OF 1,00m SEPARATION BETWEEN BACK OF WALK AND POWER.
8. SERVICE BOX FOR POWER, TELEPHONE AND CABLE T.V. TO STRADDLE PROPERTY LINE.
9. LID AND NATURALIZATION BMP'S TO BE EXPLORED FOR ALL DITCH APPLICATIONS.
10. HYDRANTS TO BE INSTALLED ON WATERMAIN SIDE HYDRANT PAD IN ACCORDANCE WITH EPCOR SPECIFICATIONS.
11. HYDRANT CONTROL VALVE TO BE STRAPPED TO TEE OR TO AN L-SHAPE HYDRANT LEAD TO BE UTILIZED AT THE SOLE DISCRETION OF EPCOR WATER.
12. STREETLIGHT CABLE CAN BE INSTALLED AT THE SAME ALIGNMENT AS POWER AND COMMUNICATIONS.
13. MULTI-PARTY UTILITIES TRENCHING EASEMENT REFER TO DETAIL #5700.
14. TRANSFORMERS TO BE PLACED ON CASE BY CASE BASIS.

LEGEND:

-  SNOW STORAGE AREA
-  PARKING
-  DRIVING LANE

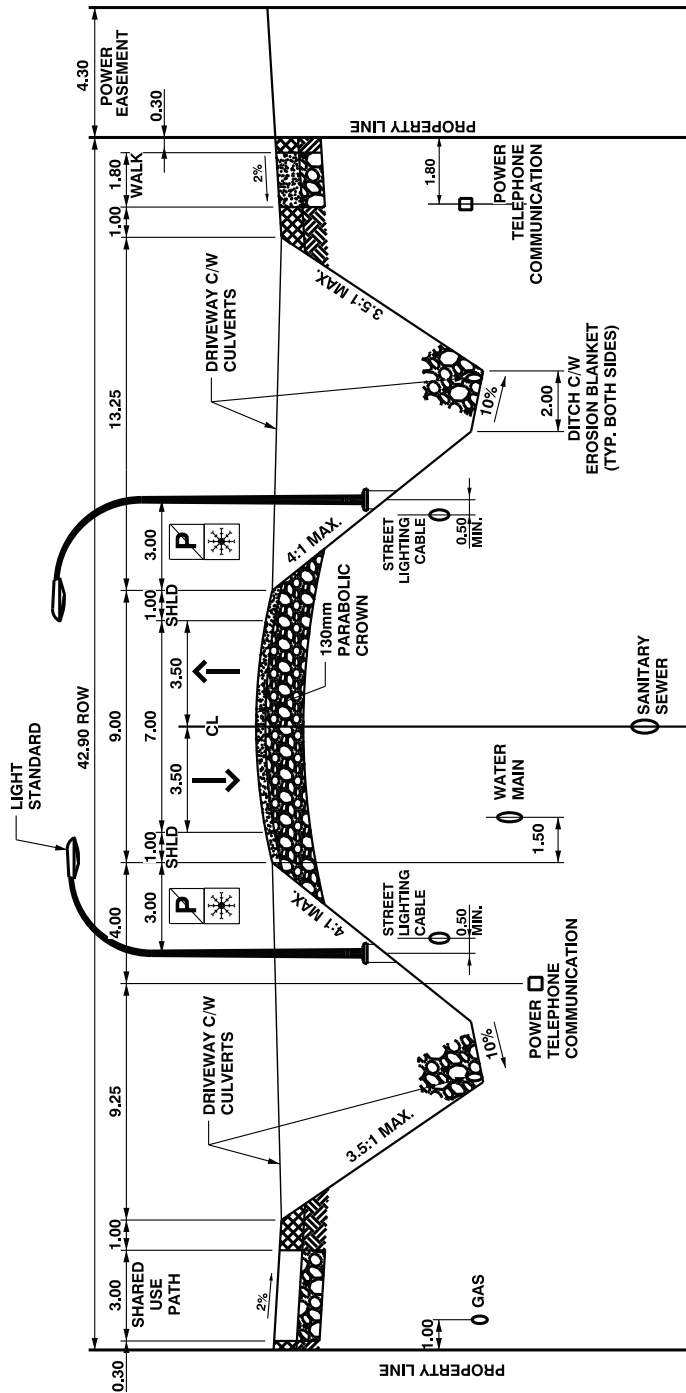

9.00m RURAL INDUSTRIAL COLLECTOR - 42.90m ROW



STANDARD DRAWING

2023-08-31

DATE APPROVED: **2018**

SCALE: **N.T.S.**

DRAWN BY: **KSYC**

CHECKED BY: **JN**



APPROVED: *M.R.*

DRAWING NUMBER: **2430**

NOTES:

1. WATER TO BE ON OPPOSITE SIDE OF MAIN POWER.
2. PIPE SIZES AND DEPTH VARIES.
3. LANDSCAPING MUST NOT COVER POLE BASE.
4. DEPTH OF MAIN POWER, TELEPHONES AND CABLE T.V. TRENCH TO BE MINIMUM 1.10m.
5. DEPTH OF GAS TRENCH TO BE MINIMUM 1.10m WITHIN ROAD ROW.
6. REQUIRE A MINIMUM OF 0.30m VERTICAL SEPERATION BETWEEN POWER AND GAS.
7. MINIMUM OF 1.00m SEPERATION BETWEEN BACK OF WALK AND POWER.
8. SERVICE BOX FOR POWER, TELEPHONE AND CABLE T.V. TO STRADDLE PROPERTY LINE.
9. LID AND NATURALIZATION BMP'S TO BE EXPLORED FOR ALL DITCH APPLICATIONS.
10. HYDRANT TO BE INSTALLED ON WATERMAIN SIDE. HYDRANT PAD REQUIRED IN ACCORDANCE WITH EPCOR SPECIFICATIONS.
11. STREETLIGHT CALBE CAN BE INSTALLED AT THE SAME ALIGNMENT AS POWER AND COMMUNICATIONS.
12. MULTI-PARTY UTILITIES TRENCHING EASEMENT REFER TO DETAIL #5700.
13. TRANSFORMERS TO BE SHOWN ON AS REQUIRED BASIS.

LEGEND:

-  SNOW STORAGE AREA
-  PARKING
-  DRIVING LANE

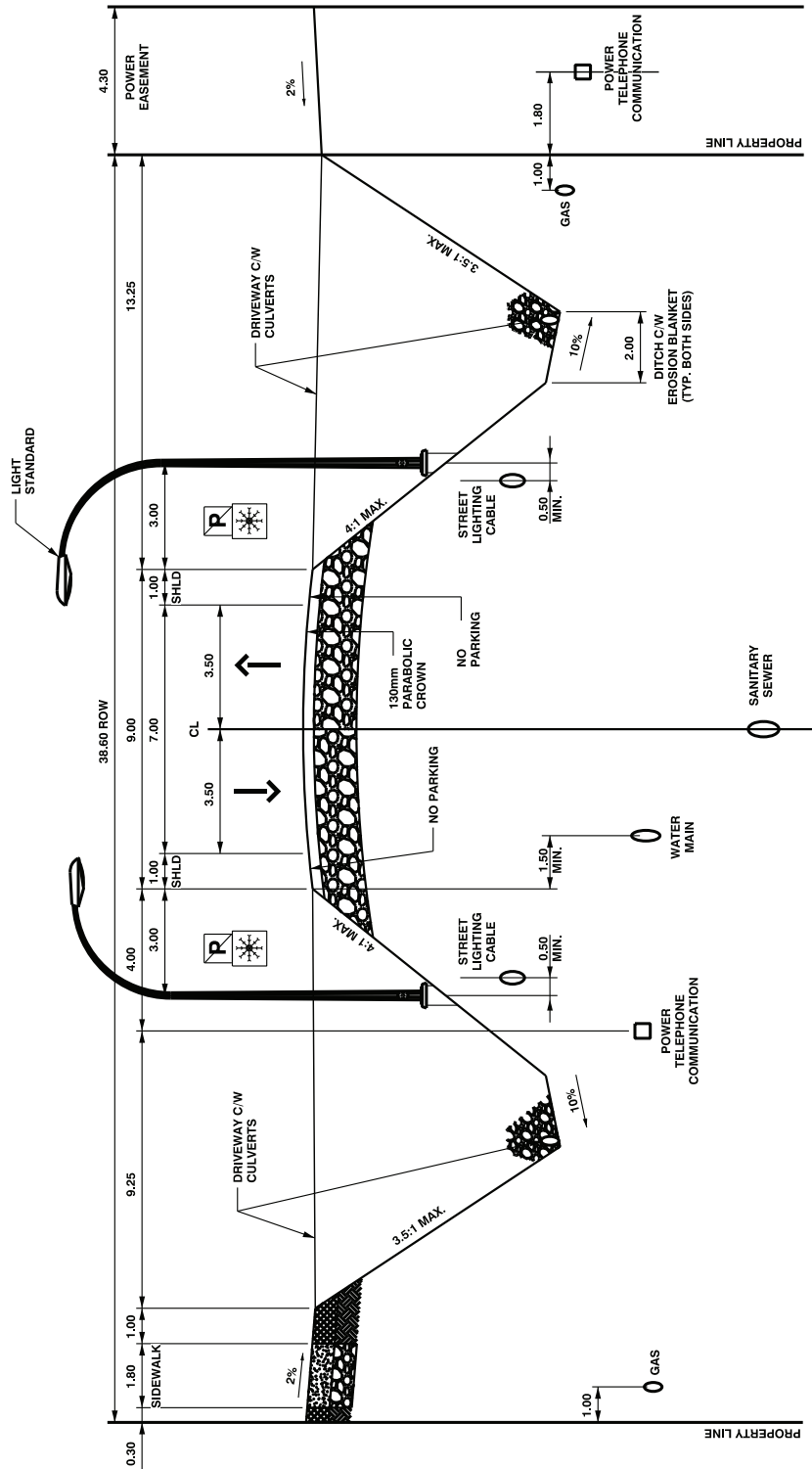

STANDARD DRAWING

2023-08-31

9.00m RURAL INDUSTRIAL LOCAL - 38.60m ROW

DATE APPROVED: 2018

SCALE: N.T.S.

DRAWN BY: KSYC

CHECKED BY: JN

APPROVED: *M.A.R.*

DRAWING NUMBER: 2431

NOTES:

1. WATER TO BE ON OPPOSITE SIDE OF MAIN POWER.
2. PIPE SIZES AND DEPTH VARY.
3. LANDSCAPING MUST NOT COVER POLE BASE.
4. DEPTH OF MAIN POWER, TELEPHONES AND CABLE T.V. TRENCH TO BE MINIMUM 1.10m.
5. DEPTH OF GAS TRENCH TO BE MINIMUM 1.10m WITHIN ROAD ROW.
6. VERTICAL SEPARATION BETWEEN POWER AND GAS TO BE MINIMUM 0.30m.
7. SEPARATION BETWEEN BACK OF WALK AND POWER TO BE MINIMUM 1.35m.
8. SERVICE BOX FOR POWER, TELEPHONE AND CABLE T.V. TO STRADDLE PROPERTY LINE.
9. ROADWAY CROSSFALLS ARE MEASURED FROM LIP OF GUTTER.
10. SIDESLOPE FROM BACK OF WALK TO PROPERTY LINE TO BE MAXIMUM 3.5:1.
11. SIDESLOPE FROM BACK OF CURB TO SIDEWALK TO BE MAXIMUM 10.00%.
12. OFFSETS SHOWN ARE FOR DESIGN SPEED OF 70km/hr. REVIEW CLEAR ZONE REQUIREMENTS FOR HIGHER DESIGN SPEED.
13. HYDRANT CONTROL VALVE TO BE STRAPPED TO TEE OR TO AN L-SHAPE HYDRANT LEAD TO BE UTILIZED AT THE SOLE DISCRETION OF EPCOR WATER.
14. STREETLIGHT CABLE CAN BE INSTALLED AT THE SAME ALIGNMENT AS POWER AND COMMUNICATIONS.
15. LANE WIDTHS BASED ON CONTEXT, REFER TO SECTION 3.2.2.3.
16. MULTI-PARTY UTILITIES TRENCHING EASEMENT REFER TO DETAIL #5700.

**ALL DIMENSIONS IN METRES UNLESS OTHERWISE NOTED**

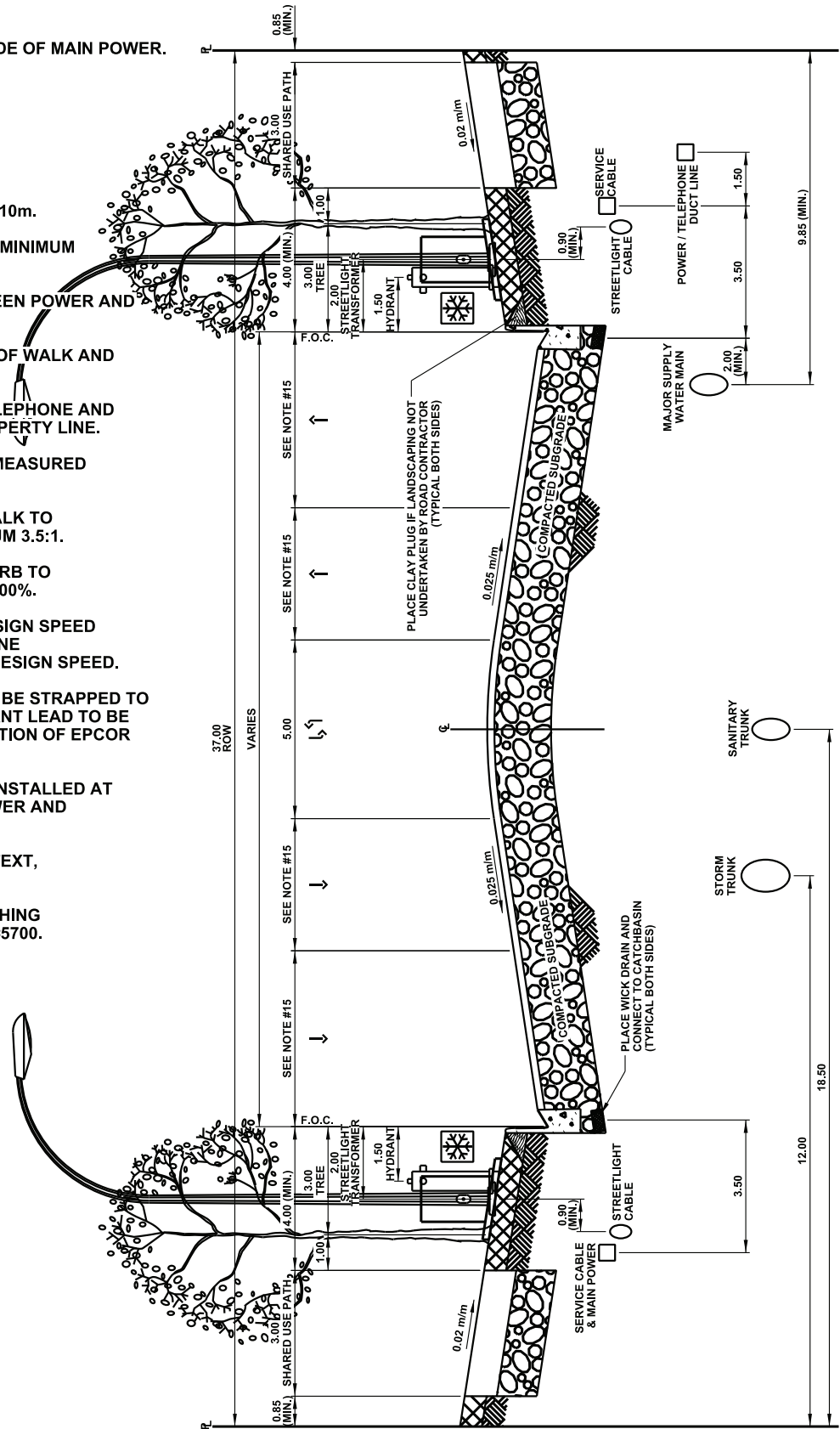

**5 LANE INDUSTRIAL URBAN UNDIVIDED ARTERIAL - 37.00m ROW**

DATE APPROVED: **2018**  
 SCALE: **N.T.S.**

DRAWN BY: **KSYC**  
 CHECKED BY: **JN**

APPROVED: *M.R.*

DRAWING NUMBER: **2500**

NOTES:

1. REFER TO COMPLETE STREETS GUIDELINES FOR INTERSECTION DESIGN PRIORITIZE SHARED-USE PATH USERS.
2. LIMIT CONFLICT POINTS AT SHARED-USE PATH FRONT DRIVES ARE NOT PERMITTED.
3. WATER TO BE ON OPPOSITE SIDE OF MAIN POWER LINE.
4. PIPE SIZES AND DEPTHS MAY VARY.
5. LANDSCAPING MUST NOT COVER POLE BASE.
6. DEPTH OF MAIN POWER, TELEPHONES AND CABLE T.V. TRENCH TO BE A MINIMUM 1.10m.
7. DEPTH OF GAS TRENCH TO BE MINIMUM 1.10m WITHIN ROAD ROW.
8. REQUIRE A MINIMUM OF 0.30m VERTICAL SEPARATION BETWEEN POWER AND GAS
9. MINIMUM OF 1.00m SEPARATION BETWEEN BACK OF WALK AND POWER.
10. SERVICE BOX FOR POWER, TELEPHONE AND CABLE T.V. TO STRADDLE PROPERTY LINE.
11. CROSS FALLS ARE MEASURED FROM LIP OF GUTTER.
12. MAXIMUM SIDESLOPE FROM BACK OF CURB TO PROPERTY LINE IS 3.5:1
13. MAXIMUM SIDESLOPE FROM BACK OF CURB TO SIDEWALK IS 10.00%.
14. SURFACE DRAINAGE TO CONFORM TO THE DRAINAGE BYLAW.
15. LANE WIDTHS BASED ON CONTEXT. REFER TO SECTION 3.2.2.3.
16. HYDRANT CONTROL VALVE TO BE STRAPPED TO TEE OR TO AN L-SHAPE HYDRANT LEAD TO BE UTILIZED AT THE SOLE DISCRETION OF EPCOR WATER.
17. STREETLIGHT CABLE CAN BE INSTALLED AT THE SAME ALIGNMENT AS POWER AND COMMUNICATIONS.
18. MEDIAN HEADER AS PER LANDSCAPE STANDARDS.
19. MULTI-PARTY UTILITIES TRENCHING EASEMENT REFER TO DETAIL #5700.

LEGEND:



LIGHT STANDARD

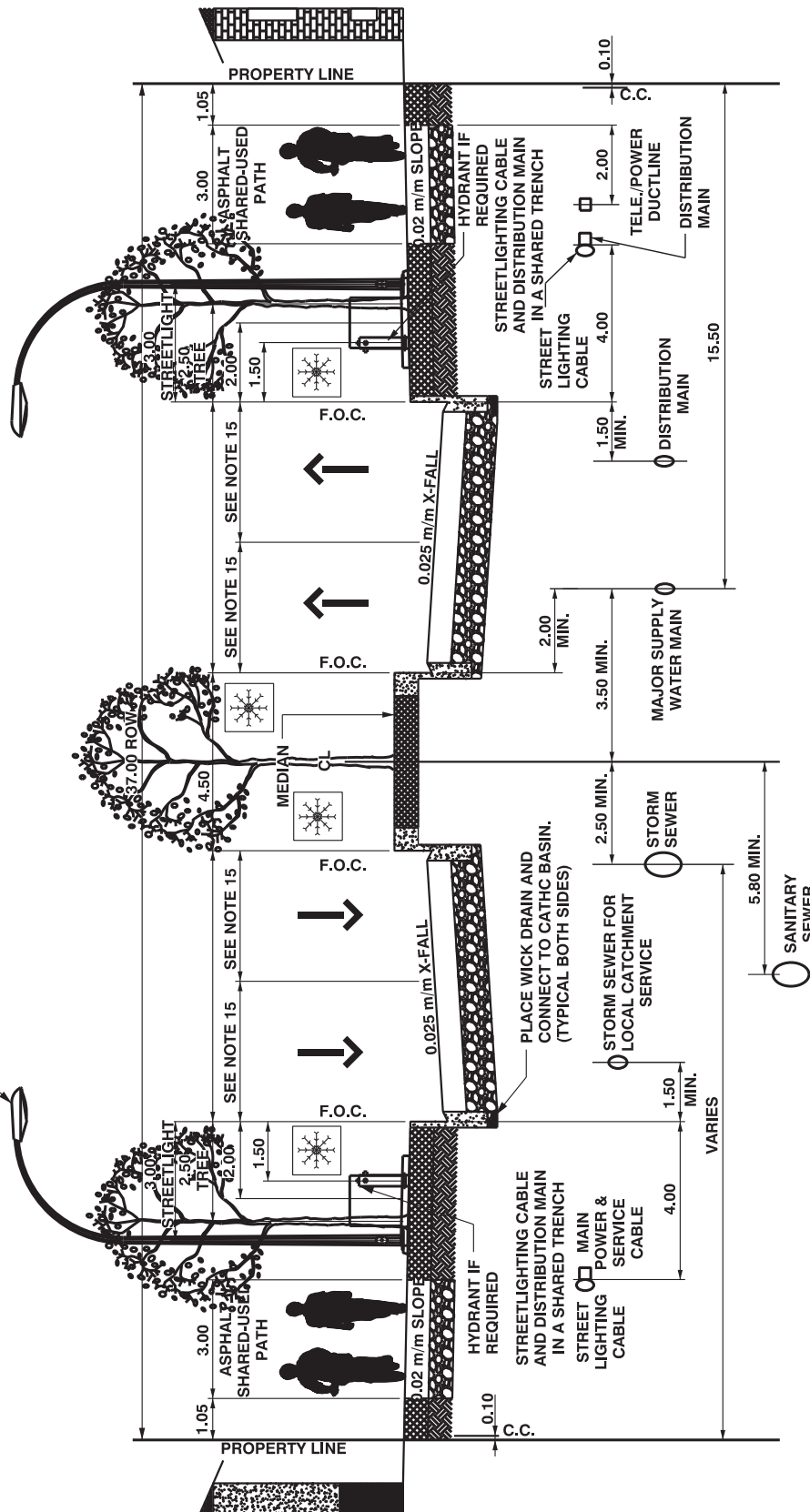

STANDARD DRAWING

DATE APPROVED: **2021**

SCALE: **N.T.S.**

DRAWN BY: **KSYC**

CHECKED BY: **MM**



APPROVED: *Mal R.*

DRAWING NUMBER: **2510**

**NOTES:**

1. REFER TO COMPLETE STREETS GUIDELINES FOR INTERSECTION DESIGN PRIORITIZE SHARED-USE PATH USERS.
2. LIMIT CONFLICT POINTS AT SHARED-USE PATH FRONT DRIVES ARE NOT PERMITTED.
3. WATER TO BE ON OPPOSITE SIDE OF MAIN POWER LINE.
4. PIPE SIZES AND DEPTHS MAY VARY.
5. LANDSCAPING MUST NOT COVER POLE BASE.
6. DEPTH OF MAIN POWER, TELEPHONES AND CABLE T.V. TRENCH TO BE A MINIMUM 1.10m.
7. DEPTH OF GAS TRENCH TO BE MINIMUM 1.10m WITHIN ROAD ROW.
8. REQUIRE A MINIMUM OF 0.30m VERTICAL SEPARATION BETWEEN POWER AND GAS
9. MINIMUM OF 1.00m SEPARATION BETWEEN BACK OF WALK AND POWER.
10. SERVICE BOX FOR POWER, TELEPHONE AND CABLE T.V. TO STRADDLE PROPERTY LINE.
11. CROSS FALLS ARE MEASURED FROM LIP OF GUTTER.
12. MAXIMUM SIDESLOPE FROM BACK OF CURB TO PROPERTY LINE IS 3.5:1
13. MAXIMUM SIDESLOPE FROM BACK OF CURB TO SIDEWALK IS 10.00%.
14. SURFACE DRAINAGE TO CONFORM TO THE DRAINAGE BYLAW.
15. LANE WIDTHS BASED ON CONTEXT. REFER TO SECTION 3.2.2.3.
16. HYDRANT CONTROL VALVE TO BE STRAPPED TO TEE OR TO AN L-SHAPE HYDRANT LEAD TO BE UTILIZED AT THE SOLE DISCRETION OF EPCOR WATER.
17. STREETLIGHT CABLE CAN BE INSTALLED AT THE SAME ALIGNMENT AS POWER AND COMMUNICATIONS.
18. MEDIAN HEADER AS PER LANDSCAPE STANDARDS.
19. MULTI-PARTY UTILITIES TRENCHING EASEMENT REFER TO DETAIL #5700.

**LEGEND:**

-  SNOW STORAGE AREA
-  DRIVING LANE

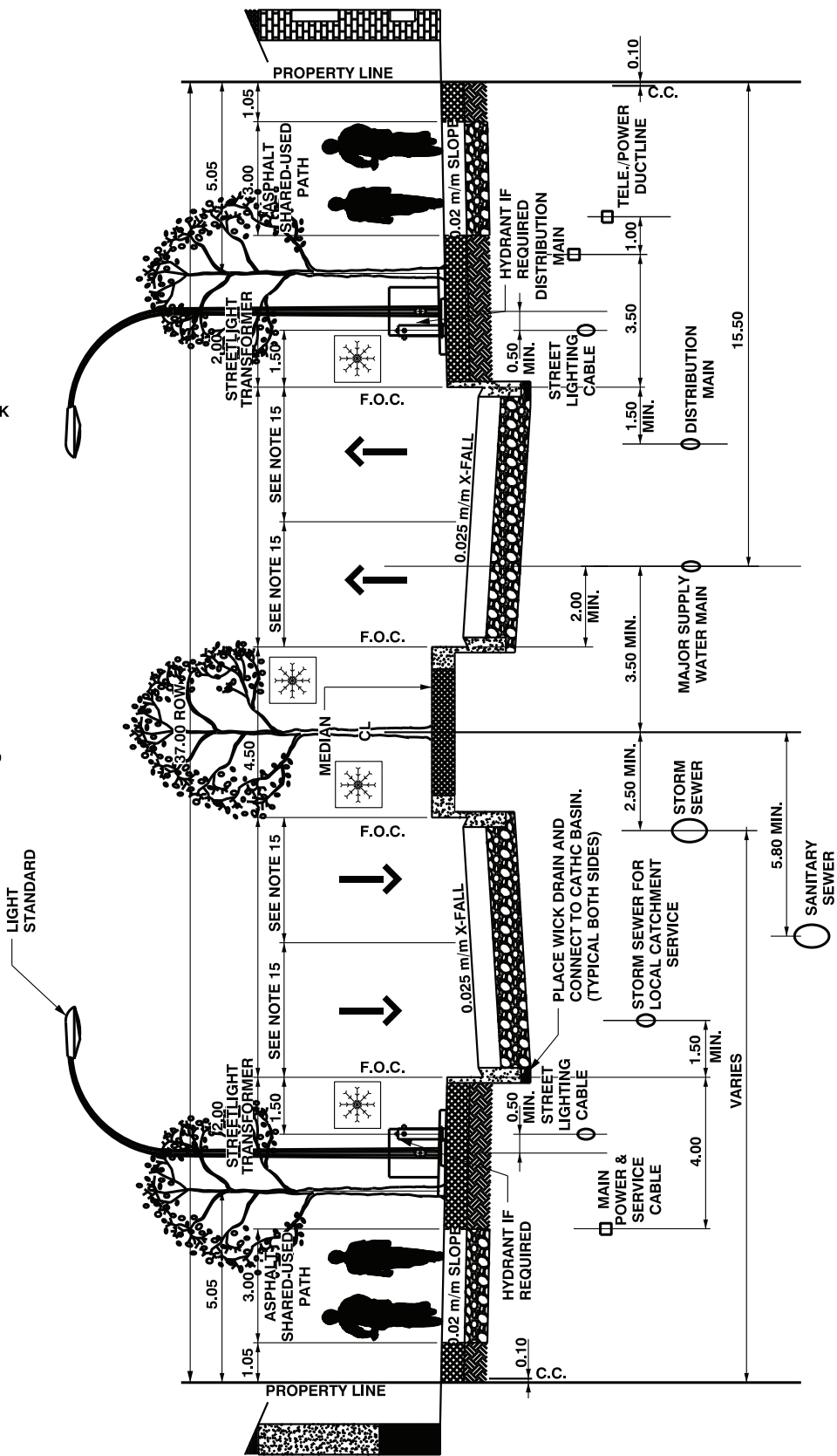

**FOUR LANE NON-STREET ORIENTED RESIDENTIAL DIVIDED ARTERIAL - 37.00m ROW - B**



STANDARD DRAWING

DATE APPROVED:

2018

DRAWN BY:

KSYC

APPROVED:

*M.R.*

DRAWING NUMBER:

2510A

SCALE:

N.T.S.



CHECKED BY:

JN

NOTES:

1. CYCLE TRACK WIDTHS AND BARRIER DESIGN BASED ON VEHICLE SPEEDS AND VOLUMES. POSSIBLE BARRIERS CAN BE DELINEATOR POSTS, CURBS, PLANTERS, ETC.
2. WATER TO BE ON OPPOSITE SIDE OF MAIN POWER LINE.
3. PIPE SIZES AND DEPTHS MAY VARY.
4. LANDSCAPING MUST NOT COVER POLE BASE.
5. DEPTH OF MAIN POWER, TELEPHONES AND CABLE T.V. TRENCH TO BE A MINIMUM 1.10m.
6. DEPTH OF GAS TRENCH TO BE MINIMUM 1.10m WITHIN ROAD ROW.
7. REQUIRE A MINIMUM OF 0.30m VERTICAL SEPARATION BETWEEN POWER AND GAS.
8. MINIMUM OF 1.00m SEPARATION BETWEEN BACK OF WALK AND POWER.
9. SERVICE BOX FOR POWER, TELEPHONE AND CABLE T.V. TO STRADDLE PROPERTY LINE.
10. CROSS FALLS ARE MEASURED FROM LIP OF GUTTER.
11. MAXIMUM SIDESLOPE FROM BACK OF CURB TO PROPERTY LINE IS 3.5:1.
12. MAXIMUM SIDESLOPE FROM BACK OF CURB TO SIDEWALK IS 10.00%.
13. SURFACE DRAINAGE TO CONFORM TO THE DRAINAGE BYLAW.
14. LANE WIDTHS BASED ON CONTEXT. REFER TO SECTION 3.2.2.3.
15. HYDRANT CONTROL VALVE TO BE STRAPPED TO TEE OR TO AN L-SHAPE HYDRANT LEAD TO BE UTILIZED AT THE SOLE DISCRETION OF EPCOR WATER.
16. STREETLIGHT CABLE CAN BE INSTALLED AT THE SAME ALIGNMENT AS POWER AND COMMUNICATIONS.
17. MEDIAN HEADER AS PER LANDSCAPE STANDARDS.
18. MULTI-PARTY UTILITIES TRENCHING EASEMENT REFER TO DETAIL #5700.

LEGEND:

-  SNOW STORAGE AREA
-  DRIVING LANE
-  CYCLE TRACK

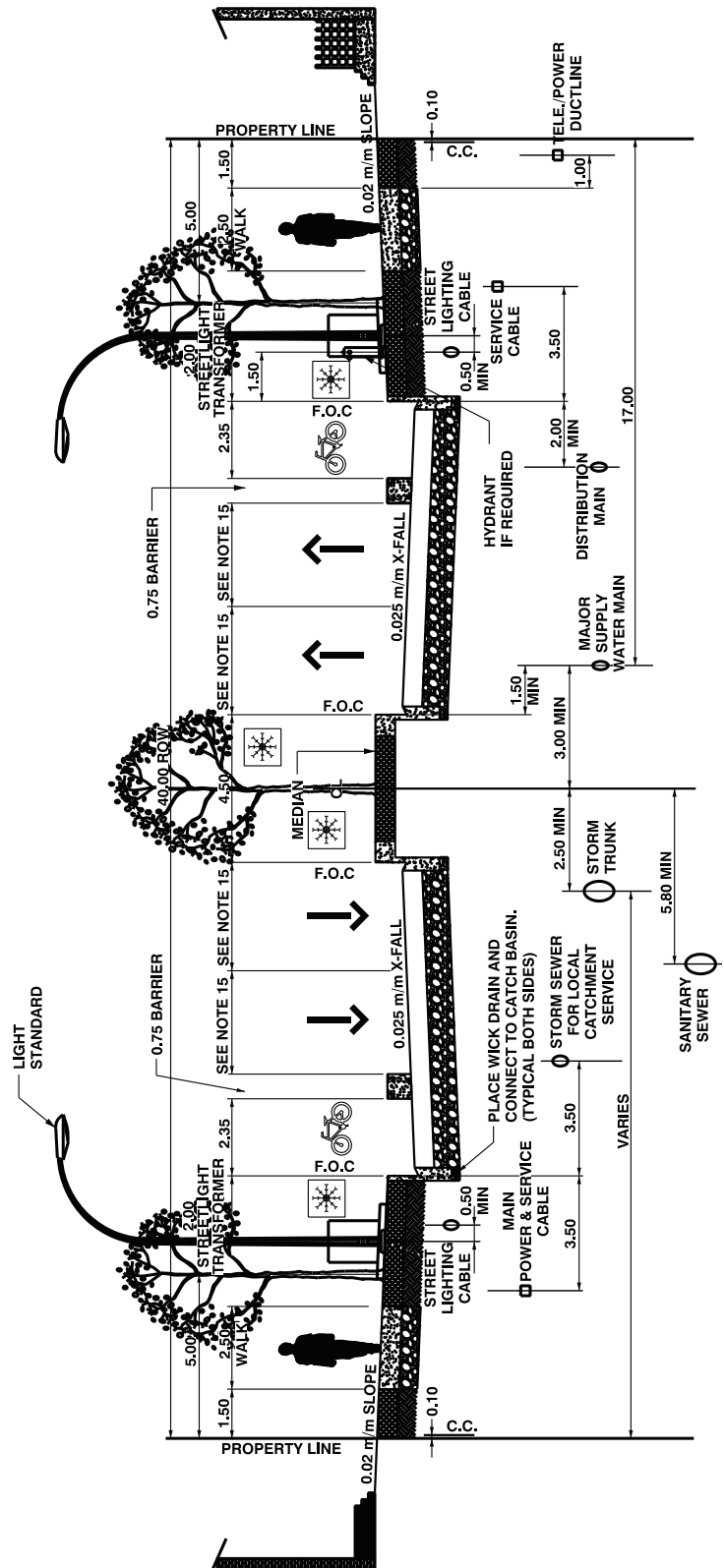

STANDARD DRAWING

2023-08-31

FOUR LANE STREET ORIENTED RESIDENTIAL DIVIDED ARTERIAL - 40.00m ROW

DATE APPROVED: **2018**

SCALE: **N.T.S.**

DRAWN BY: **KSYC**

CHECKED BY: **JN**

APPROVED: *M.R.*

DRAWING NUMBER: **2515**



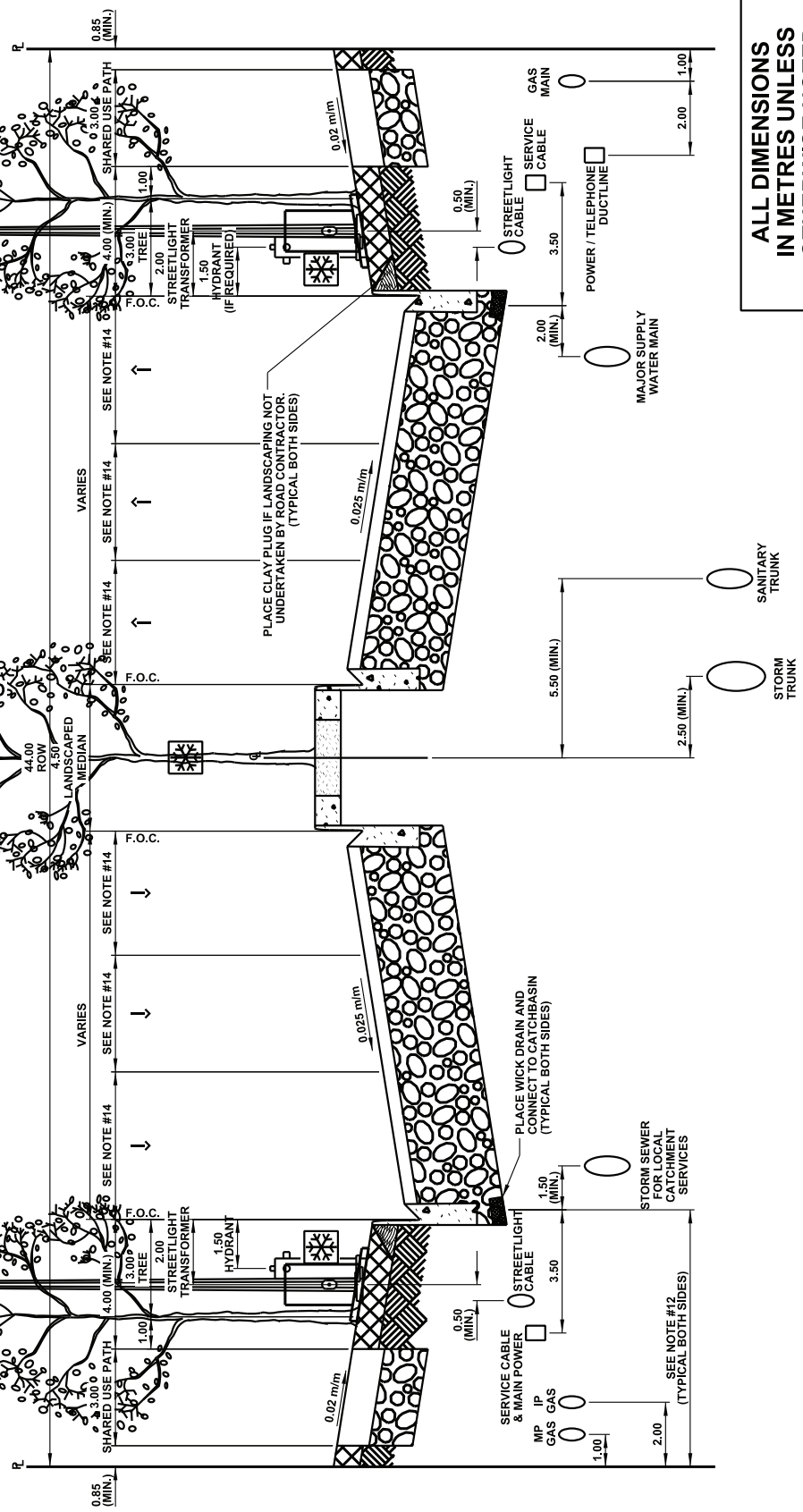

**NOTES:**

1. WATER TO BE ON OPPOSITE SIDE OF MAIN POWER.
2. LANDSCAPING MUST NOT COVER POLE BASE.
3. DEPTH OF MAIN POWER, TELEPHONES AND CABLE T.V. TRENCH TO BE MINIMUM 0.90m.
4. DEPTH OF GAS TRENCH TO BE MINIMUM 1.10m WITHIN ROAD ROW.
5. VERTICAL SEPARATION BETWEEN POWER AND GAS TO BE MINIMUM 0.30m.
6. SEPARATION BETWEEN BACK OF WALK AND POWER TO BE MINIMUM 1.00m.
7. GAS MAIN LOCATED ON EASEMENTS.
8. SERVICE BOX FOR POWER, TELEPHONE AND CABLE T.V. TO STRADDLE PROPERTY LINE.
9. CROSSFALLS ARE MEASURED FROM LIP OF GUTTER.
10. SIDESLOPE FROM BACK OF WALK TO PROPERTY LINE TO BE MAXIMUM 3.5:1.
11. OFFSETS SHOWN ARE FOR DESIGN SPEED OF 70km/hr. REVIEW CLEAR ZONE REQUIREMENTS FOR HIGHER DESIGN SPEED.
12. HYDRANT CONTROL VALVE TO BE STRAPPED TO TEE OR TO AN L-SHAPE HYDRANT LEAD TO BE UTILIZED AT THE SOLE DISCRETION OF EPCOR WATER.
13. STREETLIGHT CABLE CAN BE INSTALLED AT THE SAME ALIGNMENT AS POWER AND COMMUNICATIONS.
14. LANE WIDTHS BASED ON CONTEXT, REFER TO SECTION 3.2.2.3.
15. REFER TO LANDSCAPE STANDARDS FOR MEDIAN DETAILS.
16. MEDIAN HEADERS AS PER LANDSCAPE STANDARDS.
17. MULTI-PARTY UTILITIES TRENCHING EASEMENT REFER TO DETAIL #5700.



**ALL DIMENSIONS IN METRES UNLESS OTHERWISE NOTED**

**LEGEND:**  
 SNOW STORAGE AREA  
 DRIVING LANE



STANDARD DRAWING

**6 LANE URBAN DIVIDED ARTERIAL - 44.00m ROW**

DATE APPROVED: <b>2018</b>	DRAWN BY: <b>KSYC</b>	APPROVED: 	DRAWING NUMBER: <b>2520</b>
SCALE: <b>N.T.S.</b>	CHECKED BY: <b>JN</b>		

**NOTES:**

1. WATER TO BE ON OPPOSITE SIDE OF MAIN POWER.
2. PIPE SIZES AND DEPTH VARIES.
3. HYDRANTS TO BE INSTALLED ON BRANCH MAIN AT INTERSECTIONS OR BETWEEN WALK AND PROPERTY LINE.
4. LANDSCAPING MUST NOT COVER POLE BASE.
5. DEPTH OF MAIN POWER, TELEPHONES AND CABLE T.V. TRENCH TO BE MINIMUM 1.10m.
6. DEPTH OF GAS TRENCH TO BE MINIMUM 1.10m WITHIN ROAD ROW.
7. REQUIRE A MINIMUM OF 0.30m VERTICAL SEPARATION BETWEEN POWER AND GAS.
8. MINIMUM OF 1.35m SEPARATION BETWEEN BACK OF WALK AND POWER.
9. SERVICE BOX FOR POWER, TELEPHONE AND CABLE T.V. TO STRADDLE PROPERTY LINE.
10. CROWNS ARE MEASURED FROM EDGE OF PAVEMENT.
11. MINIMUM BOULEVARD WIDTH FOR INDUSTRIAL AREA IS 5.50m.
12. MAXIMUM SIDESLOPE FROM BACK OF WALK TO PROPERTY LINE IS 3.5:1.
13. MAXIMUM SIDESLOPE FROM EDGE OF PAVEMENT TO SIDEWALK LINE IS 10.00%.
14. LID AND NATURALIZATION BMP'S TO BE EXPLORED FOR ALL DITCH APPLICATIONS.
15. HYDRANTS TO BE INSTALLED ON WATERMAIN SIDE. HYDRANT PAD REQUIRED AS PER EPCOR SPECIFICATIONS.
16. HYDRANT CONTROL VALVE TO BE STRAPPED TO TEE OR TO AN L-SHAPE HYDRANT LEAD TO BE UTILIZED AT THE SOLE DISCRETION OF EPCOR WATER.
17. STREETLIGHT CABLE CAN BE INSTALLED AT THE SAME ALIGNMENT AS POWER AND COMMUNICATIONS.
18. MULTI-PARTY UTILITIES TRENCHING EASEMENT REFER TO DETAIL #5700.

**LEGEND:**

-  SNOW STORAGE AREA
-  DRIVING LANE

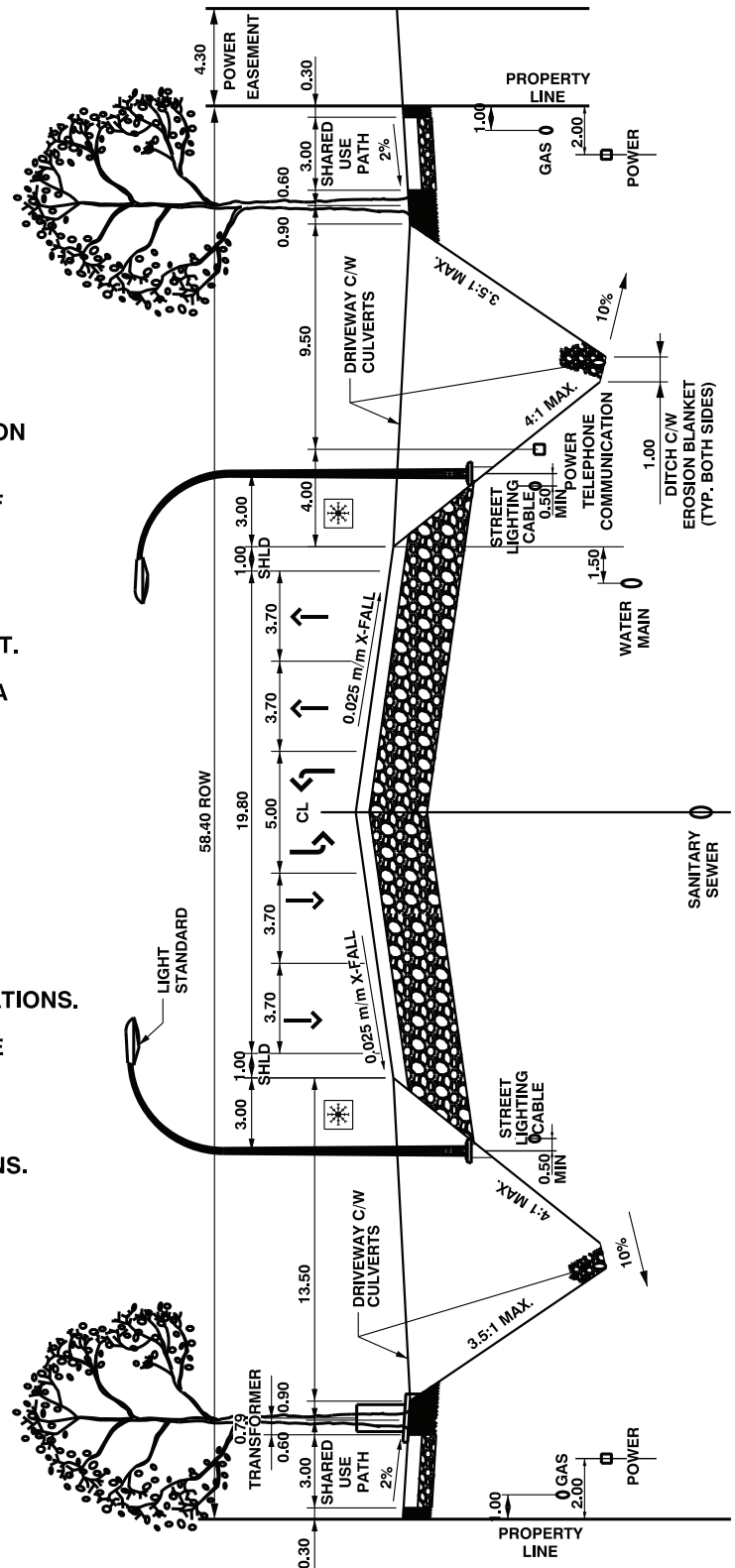

STANDARD DRAWING

**RURAL FIVE LANE INDUSTRIAL ARTERIAL (SHARED USE PATH) - 57.40m ROW**

DATE APPROVED: **2018**

DRAWN BY: **KSYC**

APPROVED: 

DRAWING NUMBER: **2530**

SCALE: **N.T.S.**

CHECKED BY: **JN**

ALL DIMENSIONS  
IN METRES UNLESS  
OTHERWISE NOTED

NOTES:

1. MAJOR WALK LOCATION VARIES IN ROW.
2. MINOR WALK LOCATION GENERALLY ON CENTER LINE.
3. LANDSCAPING MUST NOT COVER POLE BASES.
4. DEPTH OF POWER TRENCH TO BE APPROXIMATELY 1.10m.
5. DEPTH OF GAS TRENCH TO BE MINIMUM 1.10m.
6. VERTICAL SEPARATION BETWEEN POWER AND GAS TO BE MINIMUM 0.30m.
7. HORIZONTAL SEPARATION BETWEEN STORM SEWER AND POWER TO BE MINIMUM 3.00m.
8. REFER TO LANDSCAPE STANDARDS FOR TREE LOCATION AND LANDSCAPE TREATMENTS.
9. SWALE TO BE MINIMUM 0.60m.
10. STREETLIGHT CABLE CAN BE INSTALLED AT THE SAME ALIGNMENT AS POWER AND COMMUNICATIONS.

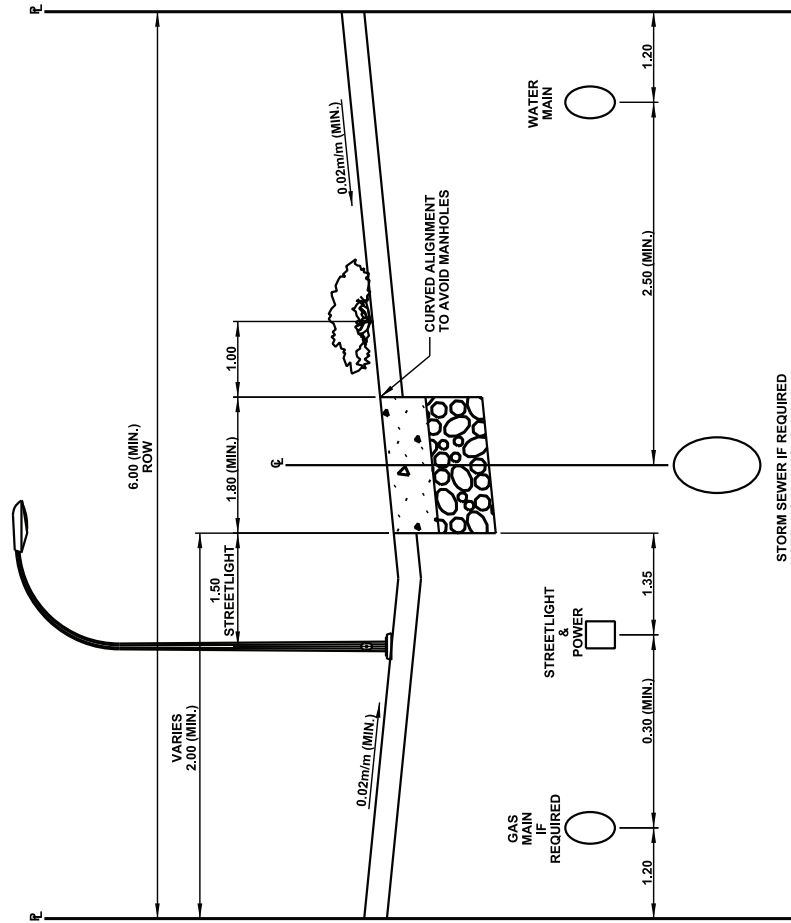

STORM SEWER IF REQUIRED  
NOTE: NO MANHOLE IN WALK



STANDARD DRAWING

2023-08-31

UTILITIES LOCATION PLAN WALKWAYS

DATE APPROVED: 2018

SCALE: N.T.S.

DRAWN BY: KSYC

CHECKED BY: JN

APPROVED: *M.R.*

DRAWING NUMBER: 2600

ALL DIMENSIONS  
IN METRES UNLESS  
OTHERWISE NOTED

NOTE:

- 1. THE RECOMMENDED MAXIMUM SLOPE OF 2.00% SHALL BE PROVIDED WITHIN ROAD RIGHT-OF-WAY FROM THE PROPERTY LINE TO THE BACK OF THE MONOWALK.
- 2. THE BELOW GRADE DRIVEWAY SLOPE / PARKADE RAMP MUST NOT EXCEED 10.00% FOR A MINIMUM DISTANCE OF 5.00m FROM THE PROPERTY LINE INTO THE SITE.
- 3. THE BELOW GRADE DRIVEWAY SLOPE / PARKADE RAMP MUST BE AT GRADE AT THE PROPERTY LINE.
- 4. NO PORTION OF THE BELOW GRADE DRIVEWAY SLOPE / PARKADE RAMP OR RETAINING WALL / GUARD RAILS WILL BE PERMITTED WITHIN ROAD RIGHT-OF-WAY.
- 5. PROPOSED RETAINING WALLS BORDERING THE BELOW GRADE DRIVEWAY SLOPE / PARKADE RAMP MUST NOT EXCEED A HEIGHT OF 0.30m FOR A DISTANCE OF 3.00m INTO THE SITE.
- 6. PROPOSED GUARD RAILS LOCATED ON RETAINING WALLS MUST NOT OBSTRUCT SIGHT LINES FOR EXITING VEHICLES.
- 7. MORE THAN A 12.00% DIFFERENCE IN THE BELOW GRADE DRIVEWAY SLOPE / PARKADE RAMP WITHIN PRIVATE PROPERTY MAY RESULT IN VEHICLES "BOTTOMING OUT" AT THE BREAK-OVER POINT.
- 8. ANY MODIFICATION TO THIS GUIDELINE OR DRAWING WILL REQUIRE THE REVIEW AND APPROVAL OF CITY OF EDMONTON.

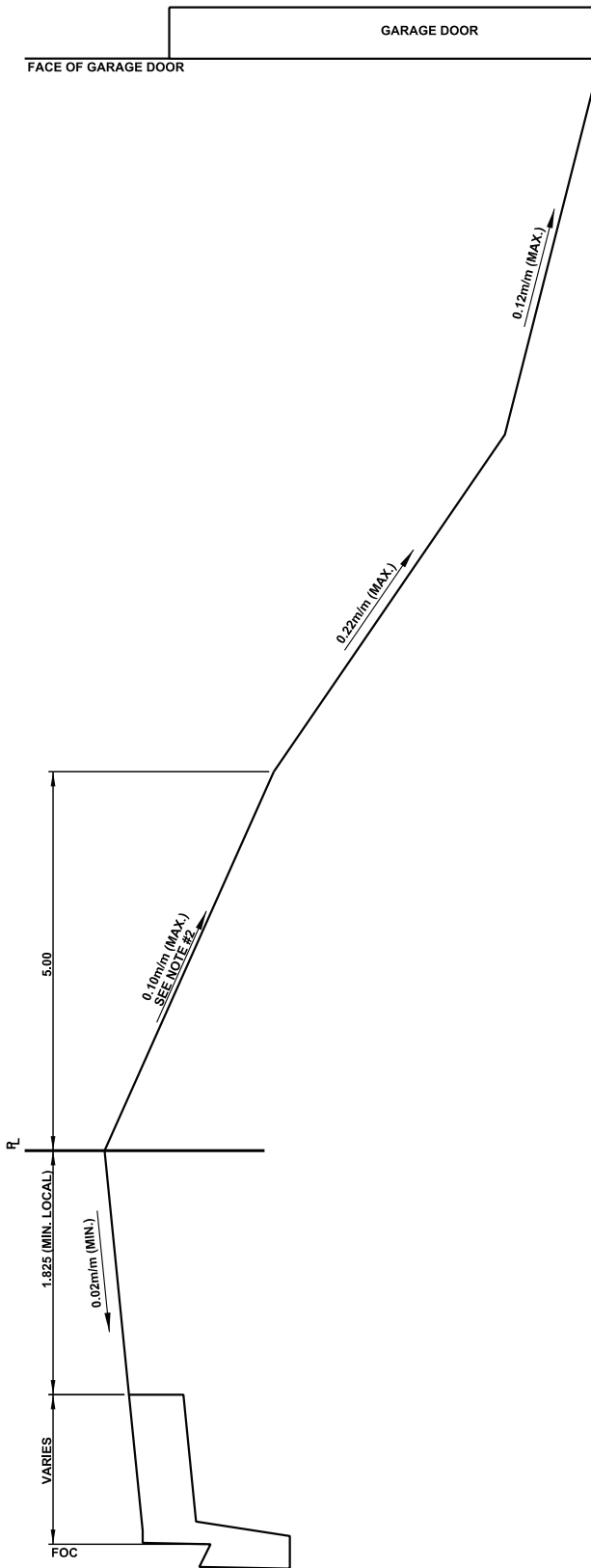

STANDARD DRAWING

2023-08-31

SLOPE REGULATION  
RESIDENTIAL PRIVATE DRIVEWAY / PARKADE RAMP  
MONOWALK

DATE APPROVED: 2018

DRAWN BY: KSYC

APPROVED: *M.R.*

DRAWING NUMBER: 2720

SCALE: N.T.S.

CHECKED BY: JN

v05

ALL DIMENSIONS  
IN METRES UNLESS  
OTHERWISE NOTED

NOTE:

1. THE RECOMMENDED MAXIMUM SLOPE OF 2.00% SHALL BE PROVIDED WITHIN ROAD RIGHT-OF-WAY FROM THE PROPERTY LINE TO THE BACK OF CURB.
2. THE BELOW GRADE DRIVEWAY SLOPE / PARKADE RAMP MUST NOT EXCEED 10.00% FOR A MINIMUM DISTANCE OF 5.00m FROM THE PROPERTY LINE INTO THE SITE.
3. THE BELOW GRADE DRIVEWAY SLOPE / PARKADE RAMP MUST BE AT GRADE AT THE PROPERTY LINE.
4. NO PORTION OF THE BELOW GRADE DRIVEWAY SLOPE / PARKADE RAMP OR RETAINING WALL / GUARD RAILS WILL BE PERMITTED WITHIN ROAD RIGHT-OF-WAY.
5. PROPOSED RETAINING WALLS BORDERING THE BELOW GRADE DRIVEWAY SLOPE / PARKADE RAMP MUST NOT EXCEED A HEIGHT OF 0.30m FOR A DISTANCE OF 3.00m INTO THE SITE.
6. PROPOSED GUARD RAILS LOCATED ON RETAINING WALLS MUST NOT OBSTRUCT SIGHT LINES FOR EXITING VEHICLES.
7. MORE THAN A 12.00% DIFFERENCE IN THE BELOW GRADE DRIVEWAY SLOPE / PARKADE RAMP WITHIN PRIVATE PROPERTY MAY RESULT IN VEHICLES "BOTTOMING OUT" AT THE BREAK-OVER POINT.
8. ANY MODIFICATION TO THIS GUIDELINE OR DRAWING WILL REQUIRE THE REVIEW AND APPROVAL OF CITY OF EDMONTON.

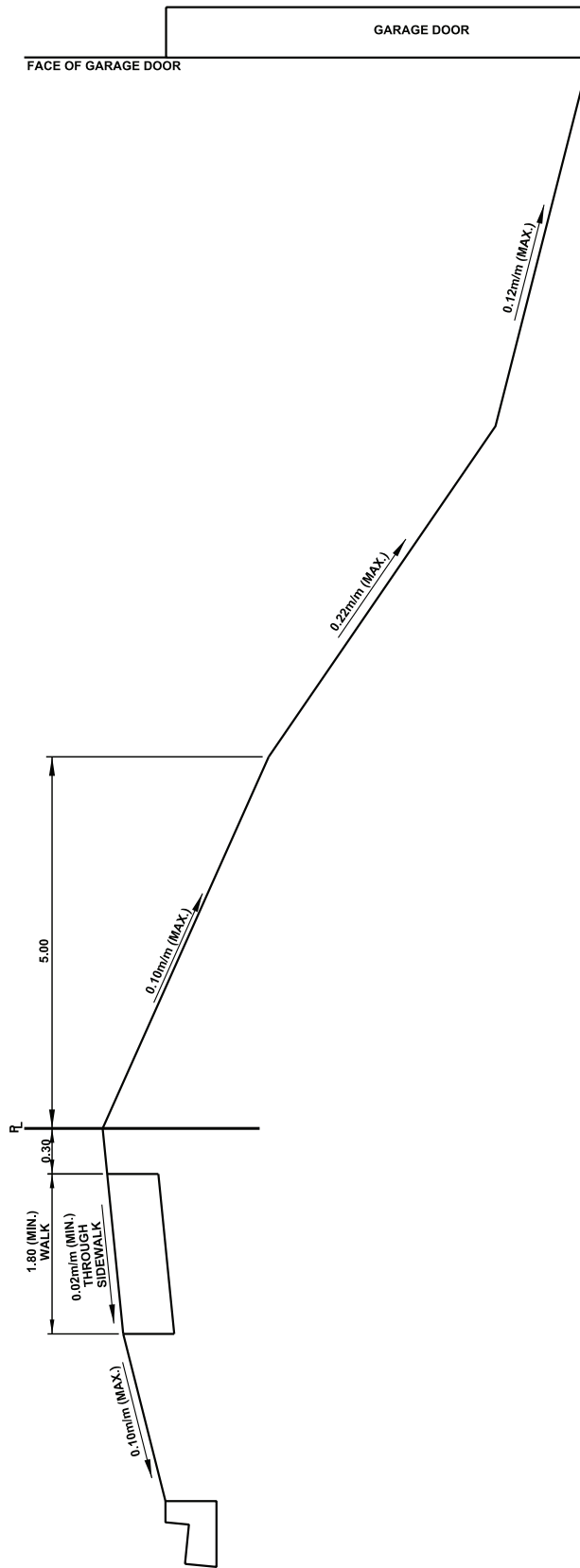

STANDARD DRAWING

2023-08-31

**SLOPE REGULATIONS  
RESIDENTIAL PRIVATE DRIVEWAY / PARKADE RAMP  
BOULEVARD WALK**

DATE APPROVED: **2018**

SCALE: **N.T.S.**

DRAWN BY: **KSYC**

CHECKED BY: **JN**

APPROVED: *M.A.R.*

DRAWING NUMBER:

**2730**

v05

Page 549



## Standard Drawings

### SECTION 3000 – Design Details

ALL DIMENSIONS  
IN METRES UNLESS  
OTHERWISE NOTED

NOTES:

- 1. ILLUSTRATION BASED ON MINIMUM TURNING REQUIREMENTS OF WB-21 DESIGN VEHICLE.

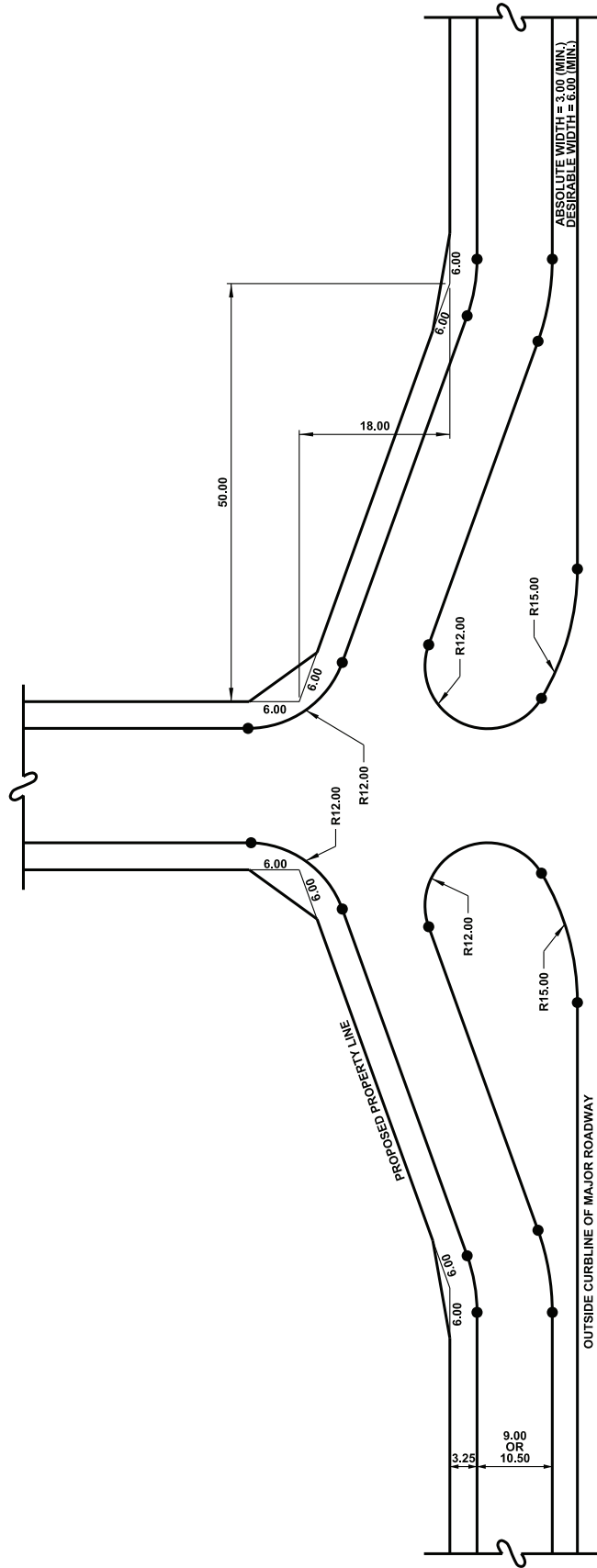

STANDARD DRAWING

2023-08-31

INDUSTRIAL SERVICE ROAD  
"BULB" ENTRANCE

DATE APPROVED: **2018**

DRAWN BY: **KSYC**

APPROVED: *M.A.R.*

DRAWING NUMBER: **3000**

SCALE: **N.T.S.**

CHECKED BY: **JN**

v05

Page 551

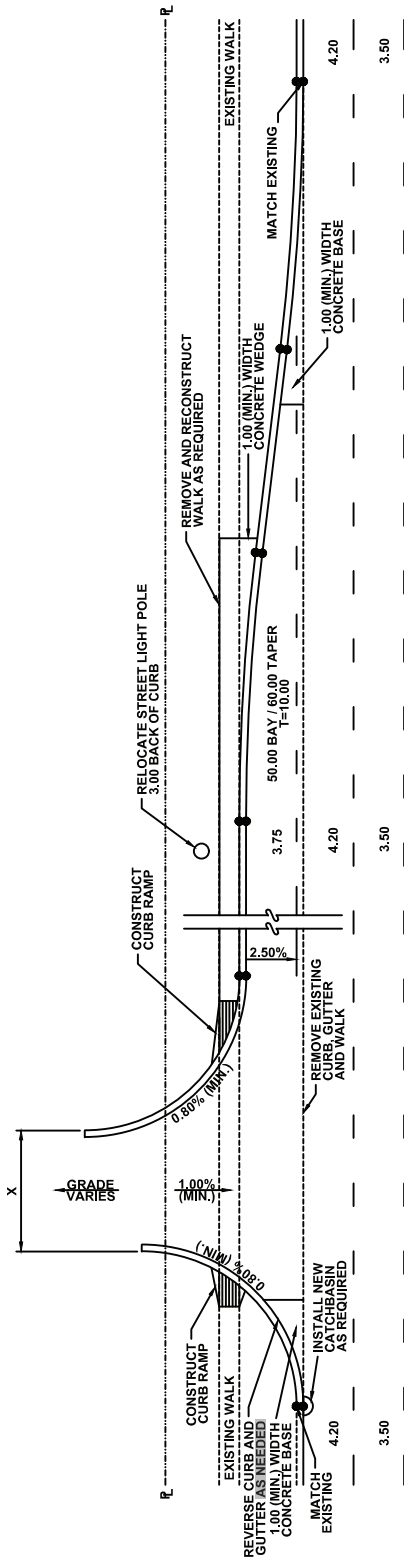

**ALTERNATE A: RIGHT TURN BAY REQUIRED**

**DEFAULT PAVEMENT STRUCTURE:**  
 - 75.00mm ASPHALT  
 - 150.00mm CONCRETE  
 - 150.00mm PLANT-MIX SOIL CEMENT  
 - 150.00mm SUBGRADE PREPARATION

**X** = 7.50 (MIN.) WIDTH - TWO WAY OPERATION  
 = 5.00 (MIN.) WIDTH - ONE WAY OPERATION  
**R** = 6.00 (MIN.) - VARIES

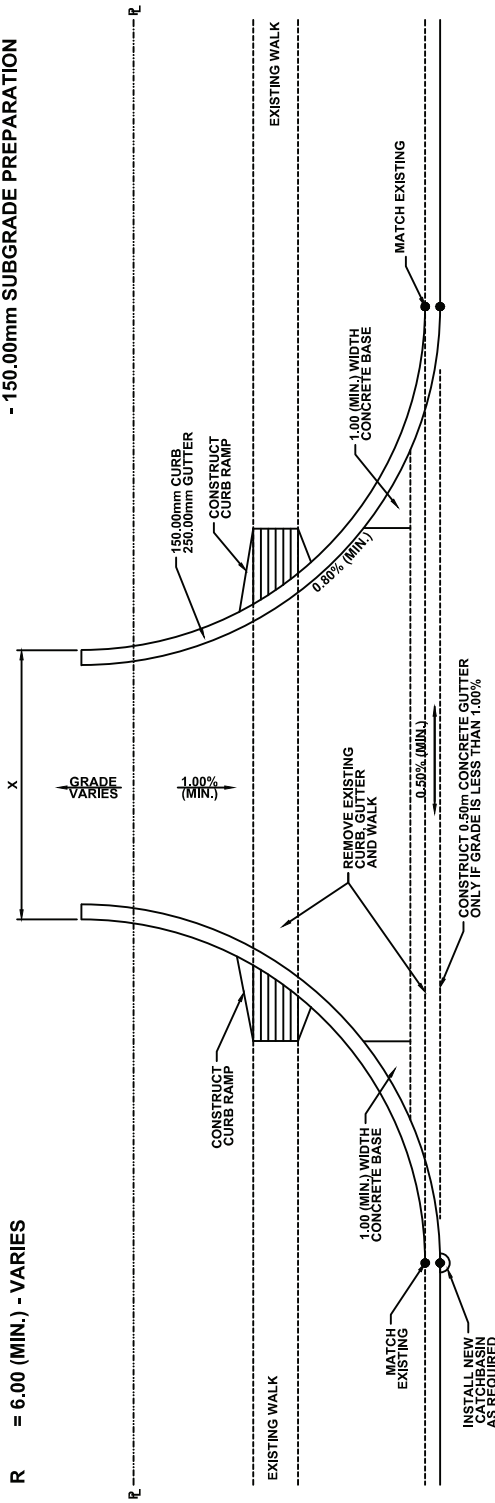

**ALTERNATE B: NO RIGHT TURN BAY REQUIRED**

**NOTES:**

1. IF CONSTRUCTION IS TO BE UNDERTAKEN BY PRIVATE DEVELOPER, THEN SERVICING AGREEMENT IS REQUIRED. CONTACT DEVELOPMENT SERVICING AGREEMENTS.
2. ALL WORK TO CONFORM TO CITY OF EDMONTON SPECIFICATIONS.
3. RE-LANDSCAPE AS REQUIRED WITH SOD.
4. ALL DIMENSIONS ARE TO LIP OF GUTTER.
5. PAVEMENT STRUCTURE TO BE CONFIRMED IN FIELD BY ENGINEER.
6. LANE WIDTHS BASED ON CONTEXT, REFER TO SECTION 3.2.2.3.
7. CURB RETURN RADIUS TO ACCOMMODATE APPROPRIATE DESIGN VEHICLE BASED ON SITE USAGE.

**ALL DIMENSIONS  
 IN METRES UNLESS  
 OTHERWISE NOTED**

**MAJOR COMMERCIAL ACCESS  
 TYPICAL CURB RETURN FORMAT**



STANDARD DRAWING

2023-08-31

DATE APPROVED: **2018**

**2018**

SCALE: **N.T.S.**

**N.T.S.**

DRAWN BY: **KSYC**

**KSYC**

CHECKED BY: **JN**

**JN**

APPROVED: *M.A.R.*

DRAWING NUMBER: **3010**

**3010**

v05

Page 552



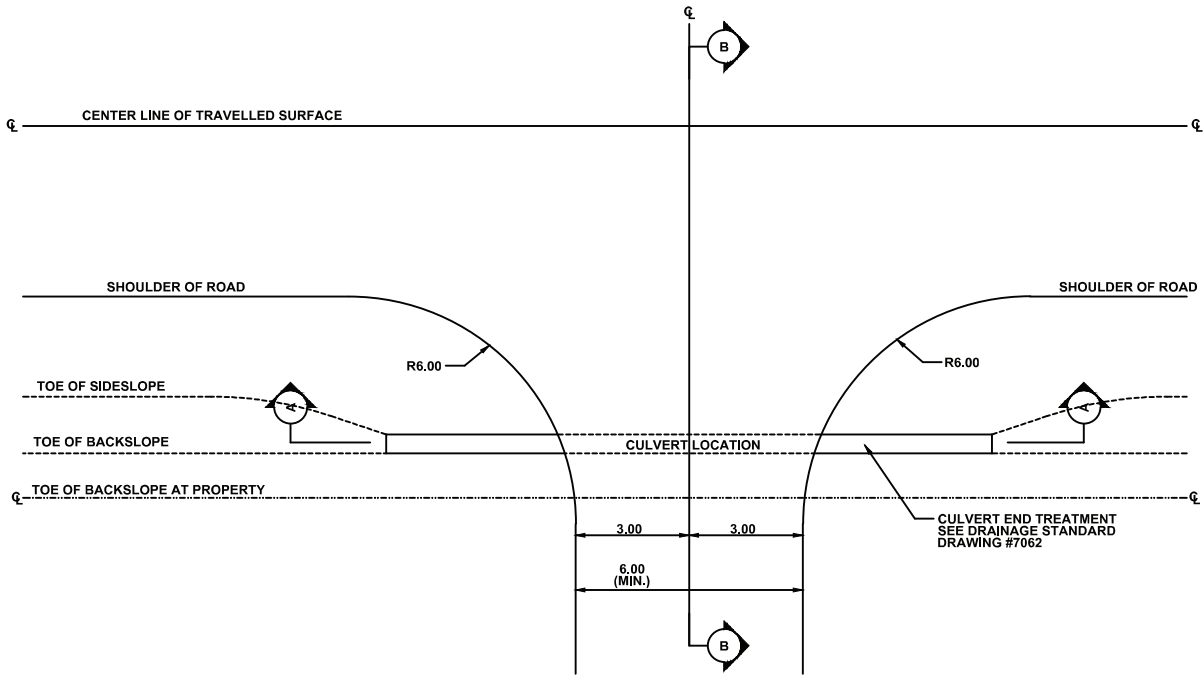

PLAN

**MINIMUM PAVEMENT STRUCTURE:**  
 - 100mm ASPHALT  
 - 200mm GRAVEL  
 - 150mm SUBGRADE PREPARATION  
 (OR APPROVED EQUIVALENT)

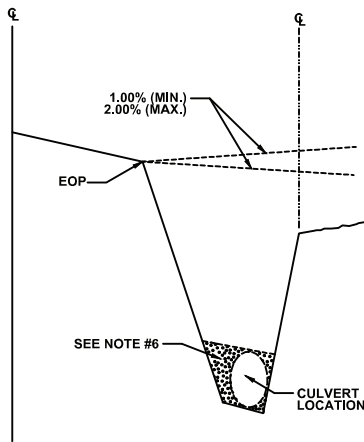

SECTION B-B

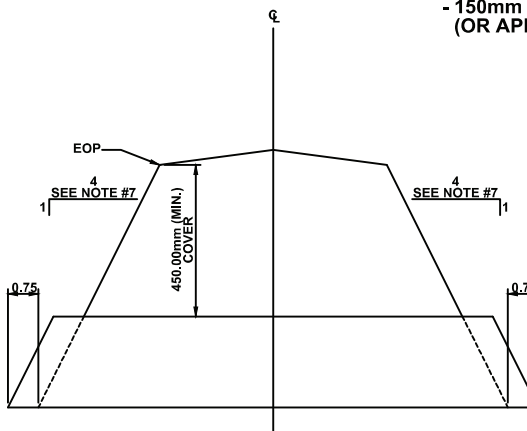

SECTION A-A

**NOTES:**

1. CULVERT MINIMUM DIAMETER 400mm C.M.P..
2. COVER DEPTH MINIMUM 450mm.
3. CULVERT TO EXTEND 0.75m BEYOND TOE OF FILL.
4. CROSSING PERMIT REQUIRED FOR ACCESS CONSTRUCTION.
5. CULVERT CONSTRUCTION TO COMPLY WITH DRAINAGE SPECIFICATION 19 CORRUGATED STEEL PIPE CULVERT.
6. SEE SPECIFICATIONS FOR COMPACTION AND BEDDING REQUIREMENTS.
7. SIDESLOPE DEPENDS ON DESIGN SPEED AND TRAFFIC VOLUME, REFER TO TAC GUIDELINES.
8. RIP RAP REQUIREMENT SEE CONSTRUCTION SPECIFICATION - 8.2 HEAVY ROCK RIP RAP AND DRAINAGE STANDARD DRAWING DR-06-19-01.

**ALL DIMENSIONS  
 IN METRES UNLESS  
 OTHERWISE NOTED**



2023-08-31

**RURAL LOCAL ACCESS**

DATE APPROVED: **2018**  
 SCALE: **N.T.S.**

DRAWN BY: **KSYC**  
 CHECKED BY: **JN**

APPROVED: *[Signature]*

DRAWING NUMBER: **3020**

v05

Page 553

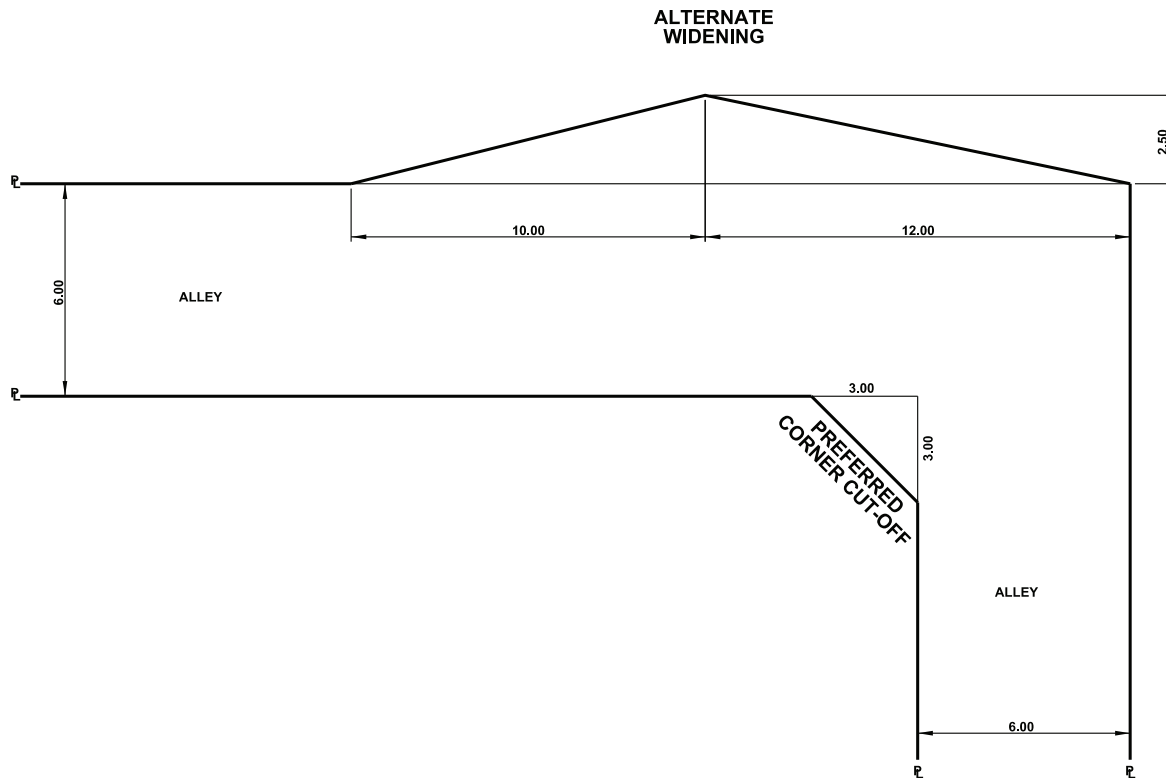

NOTES:

- 1. DESIGN VEHICLE BASED ON FRONT LOADING GARBAGE TRUCK.

**ALL DIMENSIONS  
IN METRES UNLESS  
OTHERWISE NOTED**



STANDARD DRAWING

2023-08-31

**ALLEY WIDENING IN LIEU OF 3.00m x 3.00m CORNER CUT-OFF**

DATE APPROVED: **2018**

DRAWN BY: **KSYC**

APPROVED: *M.A.R.*

DRAWING NUMBER: **3030**

SCALE: **N.T.S.**

CHECKED BY: **JN**

v05

Page 554

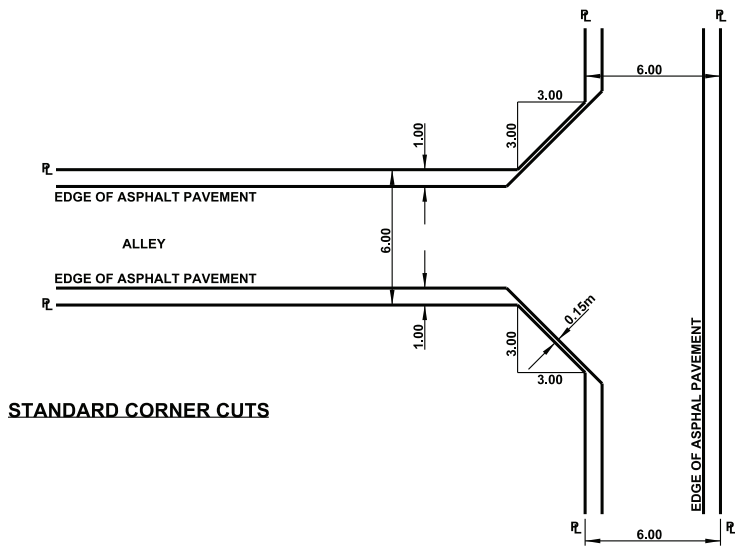
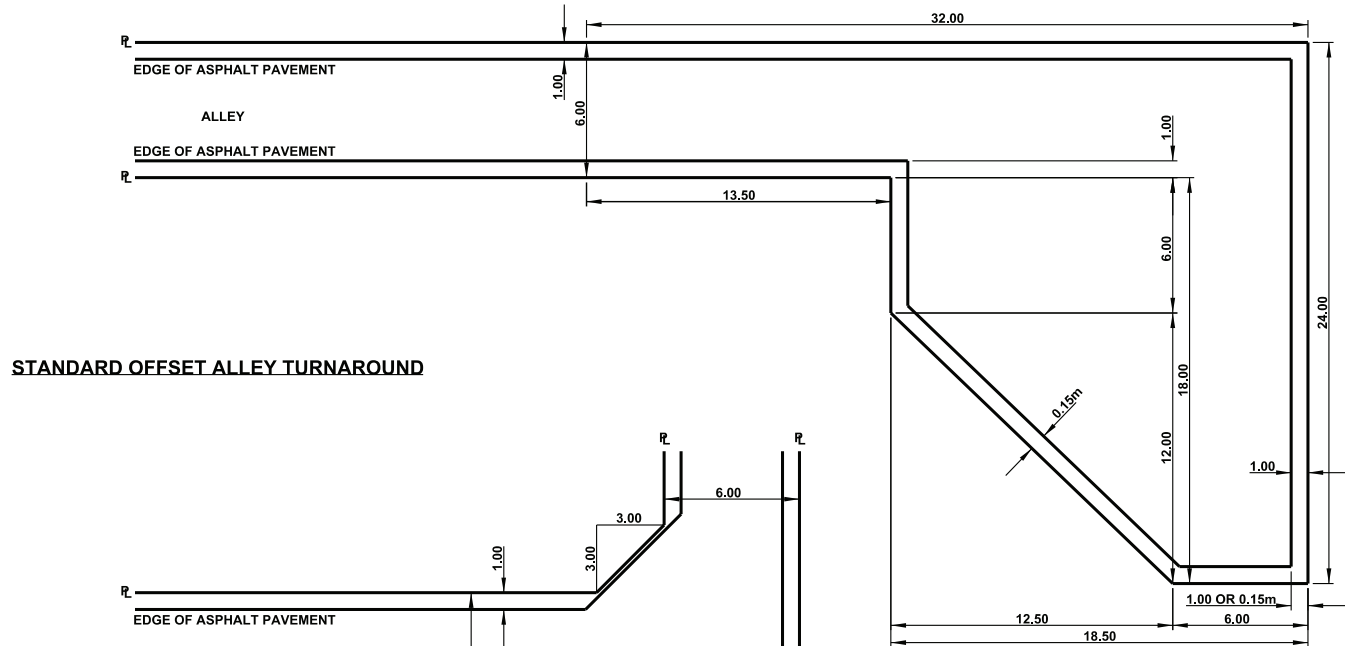
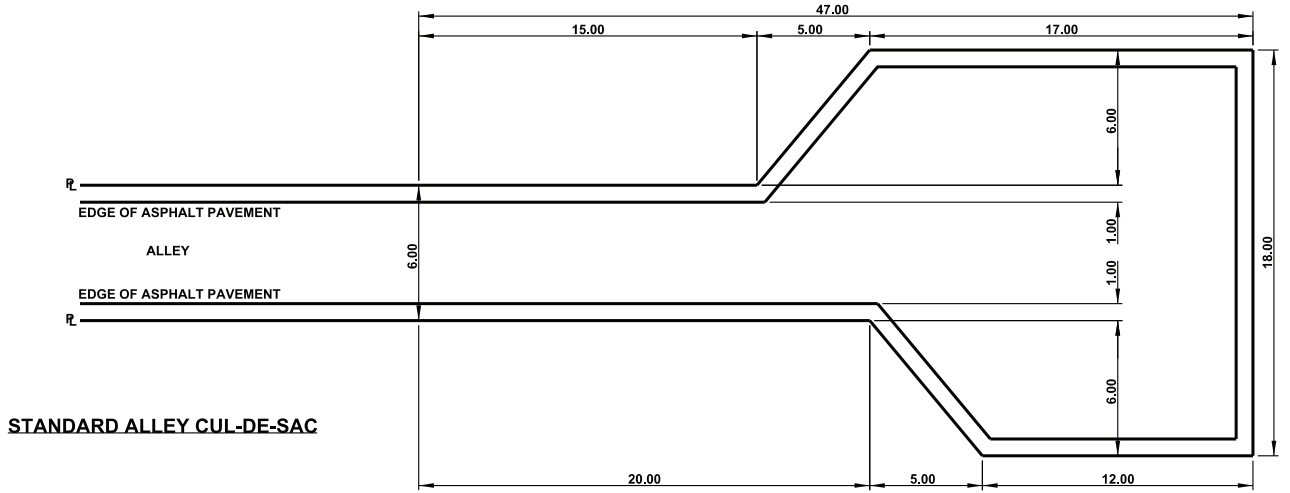

**NOTES:**

1. DESIGN VEHICLE BASED ON CITY OF EDMONTON WASTE COLLECTION VEHICLE.

**ALL DIMENSIONS  
IN METRES UNLESS  
OTHERWISE NOTED**



**PUBLIC ALLEY CUL-DE-SAC AND CORNER CUTS**

DATE APPROVED: **2018**  
SCALE: **N.T.S.**

DRAWN BY: **KSYC**  
CHECKED BY: **JN**

APPROVED: *M.A.R.*

DRAWING NUMBER: **3040**

**ALL DIMENSIONS  
IN METRES UNLESS  
OTHERWISE NOTED**

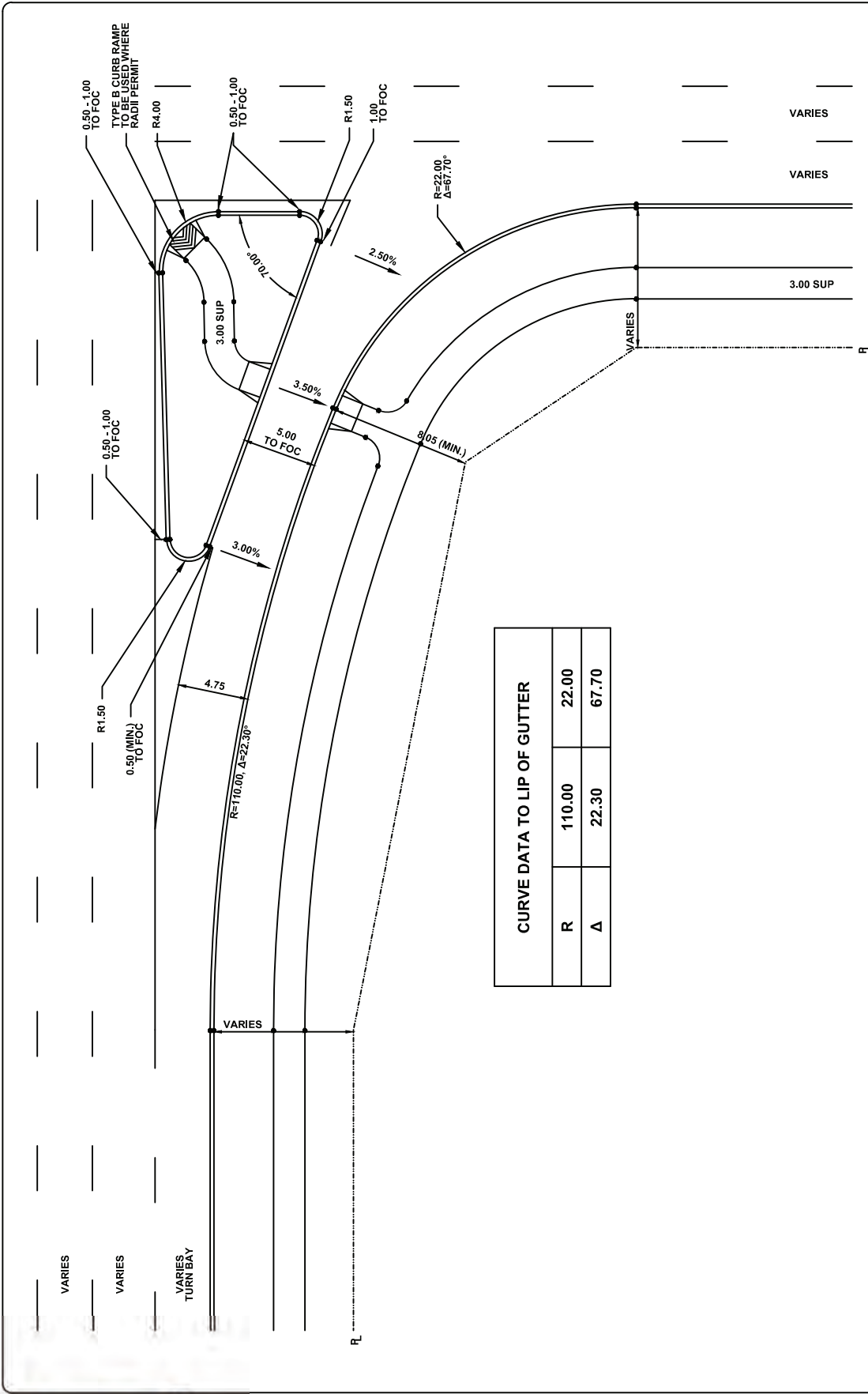

- NOTES:**
1. ALL RADII ARE TO LIP OF GUTTER.
  2. PAVEMENT MARKING OFFSETS ARE TO FACE OF CURB.
  3. THE ABOVE CURVE DATE IS APPLICABLE WITHIN 10.00° DEFLECTION FROM 90.00°.
  4. RIGHT TURN CUT-OFF AND RADII TO BE REVIEWED / ADJUSTED TO ACCOMMODATE DESIGN TRUCK CLASSIFICATION (WB-21).
  5. LENGTH OF SOLID PAINTED GORE VARIES BASED ON VEHICLE ENTRY/EXIT ANGLES.
  6. TAPER / BAY LENGTHS ARE BASED ON TRAFFIC VOLUME.
  7. FOR MINIMUM DISTANCE BETWEEN INTERSECTION AND ACCESSES, SEE ACCESS MANAGEMENT GUIDELINES.



**RIGHT TURN STANDARD  
ARTERIAL TO ARTERIAL  
CHANNELIZED HIGH ENTRY ANGLE (YIELD CONDITION)**

DATE APPROVED: **2018**  
SCALE: **N.T.S.**

DRAWN BY: **KSYC**  
CHECKED BY: **JN**

APPROVED: *M.R.*

DRAWING NUMBER: **3100**

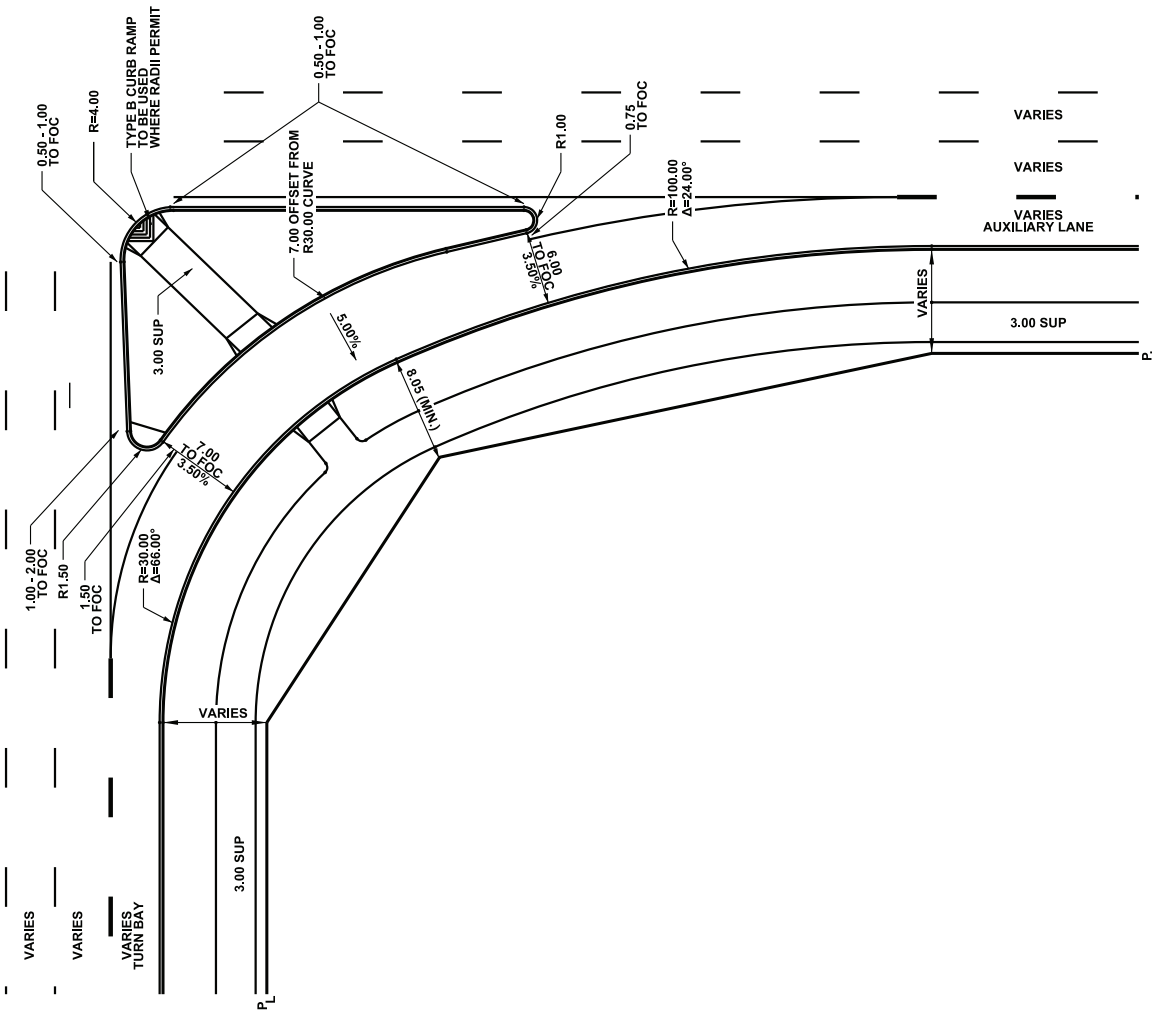

ALL DIMENSIONS  
IN METRES UNLESS  
OTHERWISE NOTED

CURVE DATA TO LIP OF GUTTER	
R	30.00
Δ	66.00
	24.00

- NOTES:
1. ALL RADII ARE TO LIP OF GUTTER.
  2. PAVEMENT MARKING OFFSETS ARE TO FACE OF CURB.
  3. THE ABOVE CURVE DATA IS APPLICABLE WITHIN 10.00° DEFLECTION FROM 90.00°.
  4. RIGHT TURN CUT-OFF TO BE REVIEWED / ADJUSTED TO ACCOMMODATE DESIGN TRUCK CLASSIFICATION (WB-21).
  5. LENGTH OF SOLID PAINTED GORE VARIES BASED ON VEHICLE ENTRY/EXIT ANGLES.
  6. TAPER / BAY LENGTHS ARE BASED ON TRAFFIC VOLUME.
  7. FOR MINIMUM DISTANCE BETWEEN INTERSECTION AND ACCESSES, SEE ACCESS MANAGEMENT GUIDELINES.



STANDARD DRAWING

**RIGHT TURN STANDARD  
ARTERIAL TO ARTERIAL  
CHANNELIZED LOW EXIT ANGLE (FREE FLOW)**

DATE APPROVED: **2018**  
SCALE: **N.T.S.**

DRAWN BY: **KSYC**  
CHECKED BY: **JN**

APPROVED: *M.L.R.*

DRAWING NUMBER:  
**3110**

**ALL DIMENSIONS  
IN METRES UNLESS  
OTHERWISE NOTED**

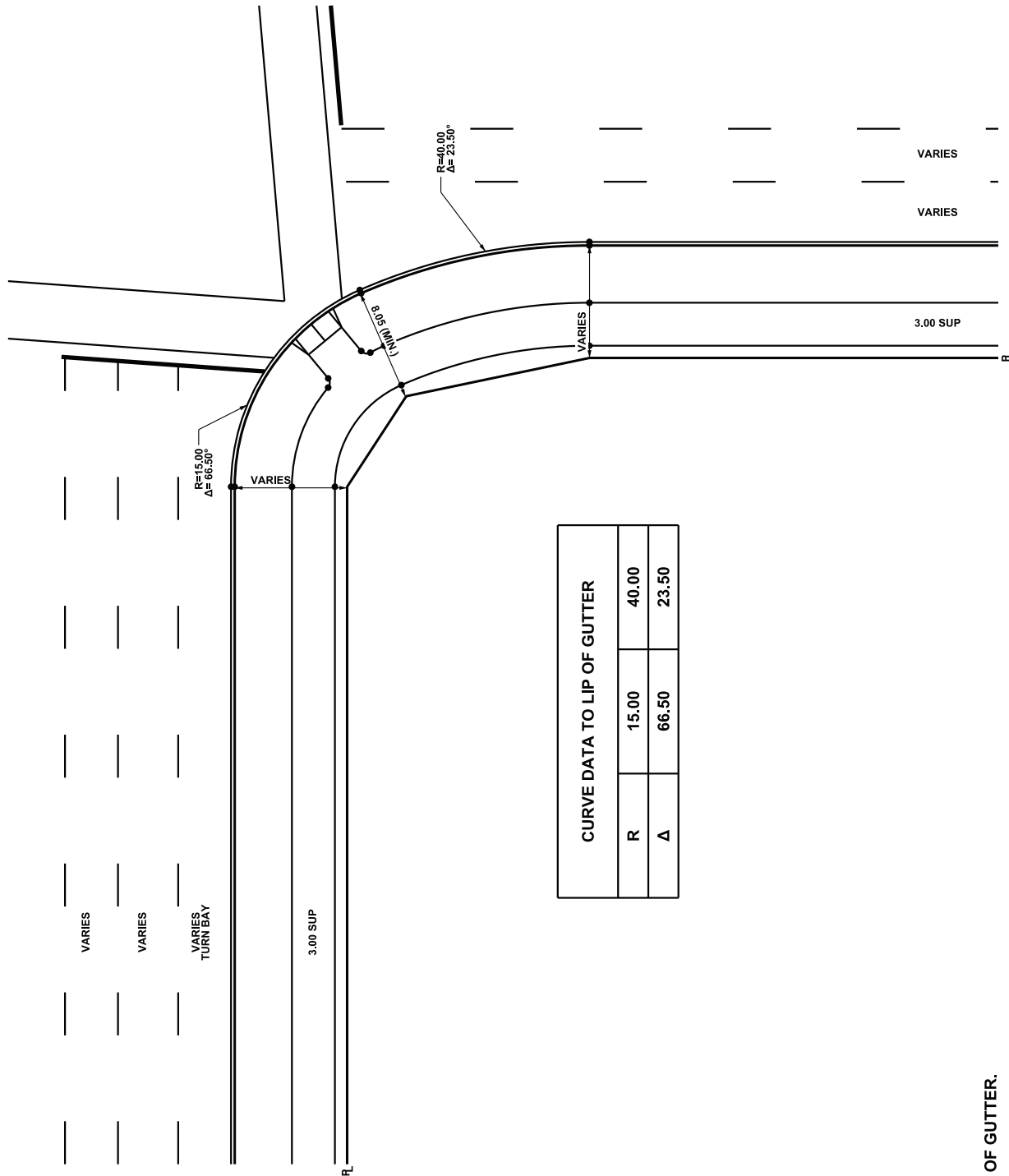

CURVE DATA TO LIP OF GUTTER	
R	40.00
Δ	23.50

- NOTES:**
1. ALL RADII ARE TO LIP OF GUTTER.
  2. PAVEMENT MARKING OFFSETS ARE TO FACE OF CURB.
  3. THE ABOVE CURVE DATA IS APPLICABLE WITHIN 10.00° DEFLECTION FROM 90.00°.
  4. RIGHT TURN CUT-OFF TO BE REVIEWED / ADJUSTED TO ACCOMMODATE DESIGN TRUCK CLASSIFICATION (WB-21).
  5. LENGTH OF SOLID PAINTED GORE VARIES BASED ON VEHICLE ENTRY/EXIT ANGLES.
  6. TAPER / BAY LENGTHS ARE BASED ON TRAFFIC VOLUME.
  7. FOR MINIMUM DISTANCE BETWEEN INTERSECTION AND ACCESSES, SEE ACCESS MANAGEMENT GUIDELINES.



**RIGHT TURN STANDARD  
ARTERIAL TO ARTERIAL  
UNCHANNELIZED SIMPLE CURVE (STOP CONDITION)**

DATE APPROVED: **2018**  
SCALE: **N.T.S.**

DRAWN BY: **KSYC**  
CHECKED BY: **JN**

APPROVED: *M.L.R.*

DRAWING NUMBER: **3120**

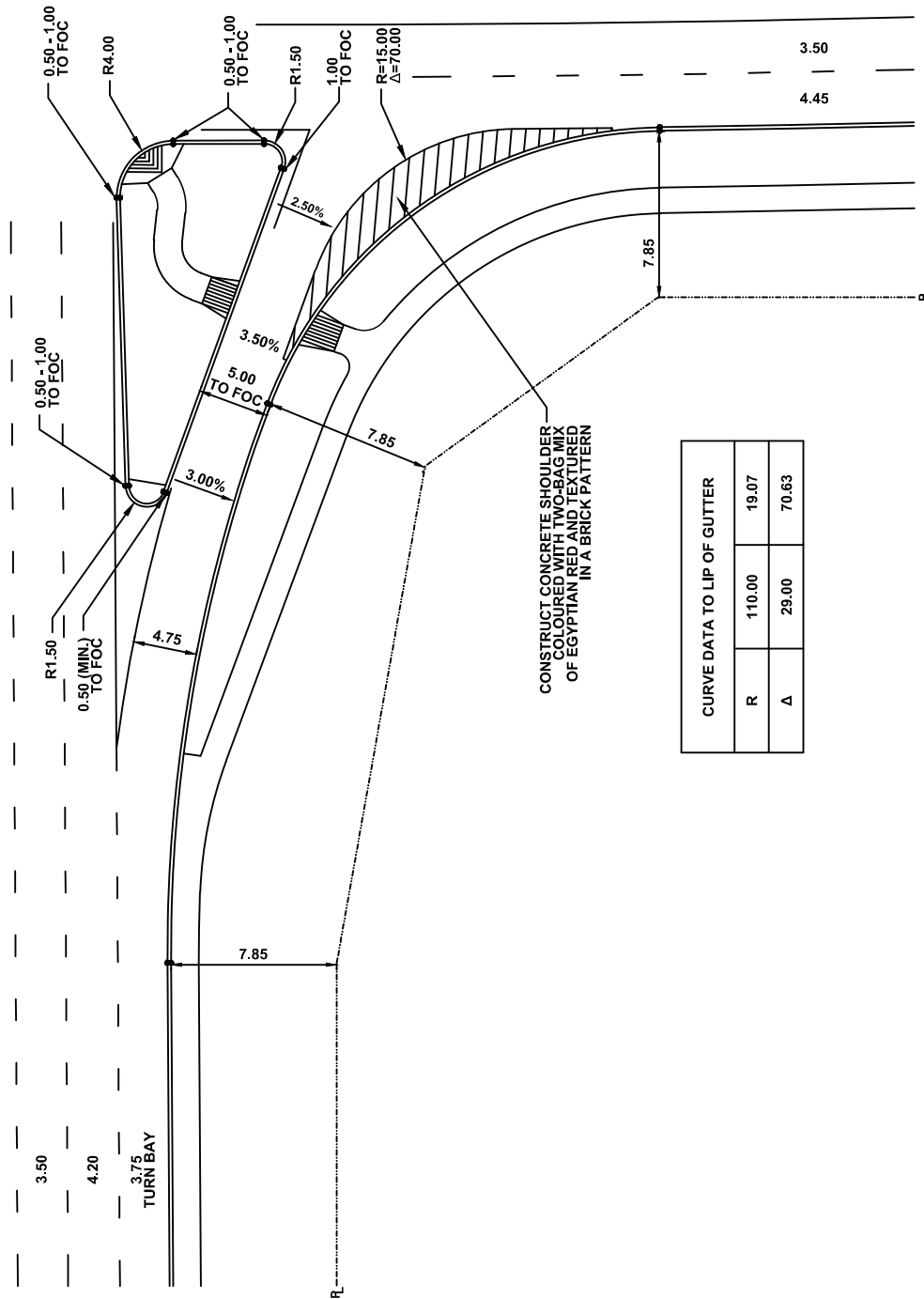

**ALL DIMENSIONS  
 IN METRES UNLESS  
 OTHERWISE NOTED**

- NOTES:
1. ALL RADII ARE TO LIP OF GUTTER.
  2. PAVEMENT MARKING OFFSETS ARE TO FACE OF CURB.
  3. THE ABOVE CURVE DATA IS APPLICABLE WITHIN 10.00' DEFLECTION FROM 90.00°.
  4. LENGTH OF SOLID PAINTED GORE VARIES BASED ON VEHICLE ENTRY/EXIT ANGLES.
  5. TAPER / BAY LENGTHS ARE BASED ON TRAFFIC VOLUME.
  6. FOR MINIMUM DISTANCE BETWEEN INTERSECTION AND ACCESSES, SEE ACCESS MANAGEMENT GUIDELINES.

**RIGHT TURN WITH MOUNTABLE CURB**

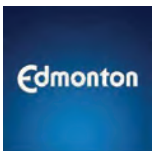

STANDARD DRAWING

2023-08-31

DATE APPROVED: **2023**

SCALE: **N.T.S.**

DRAWN BY: **RHF**

CHECKED BY: **MW**

APPROVED: *Matthew Penning*

DRAWING NUMBER: **3130**

v05

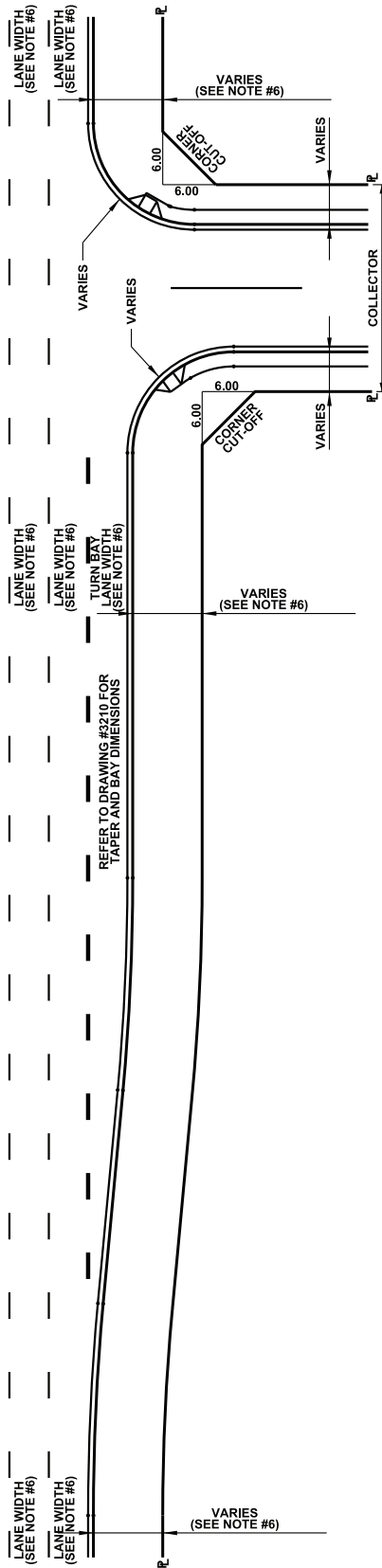

**TYPE I  
RIGHT TURN BAY REQUIRED**

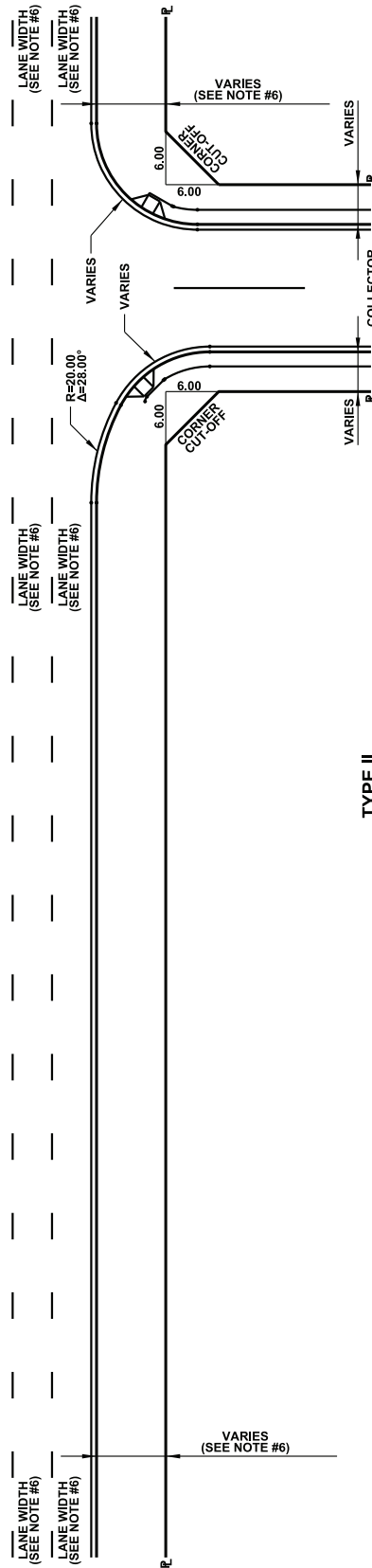

**TYPE II  
RIGHT TURN BAY NOT REQUIRED**

**MAIN LINE DESIGN SPEED = 70 km/hr**  
**ALL DIMENSIONS  
IN METRES UNLESS  
OTHERWISE NOTED**

**NOTES:**

1. ALL RADII ARE TO LIP OF GUTTER.
2. OFFSET DISTANCE ARE TO FACE OF CURB.
3. PAVEMENT MARKINGS ARE TO BE MEASURED FROM FACE OF CURB.
4. BAY LENGTH TO BE DETERMINED BY TRAFFIC SPEED AND VOLUME.
5. PROPERTY LINE REQUIREMENT WILL INCREASE IF BERM / FENCE IS REQUIRED.
6. LANE AND BOULEVARD WIDTHS BASED ON CONTEXT, SEE SECTION 3.2.2.3.



STANDARD DRAWING

2023-08-31

**RIGHT TURN BAY STANDARD  
ARTERIAL TO COLLECTOR**

DATE APPROVED: **2018**

SCALE: **N.T.S.**

DRAWN BY: **KSYC**

CHECKED BY: **JN**

APPROVED: *M.L.R.*

DRAWING NUMBER: **3200**



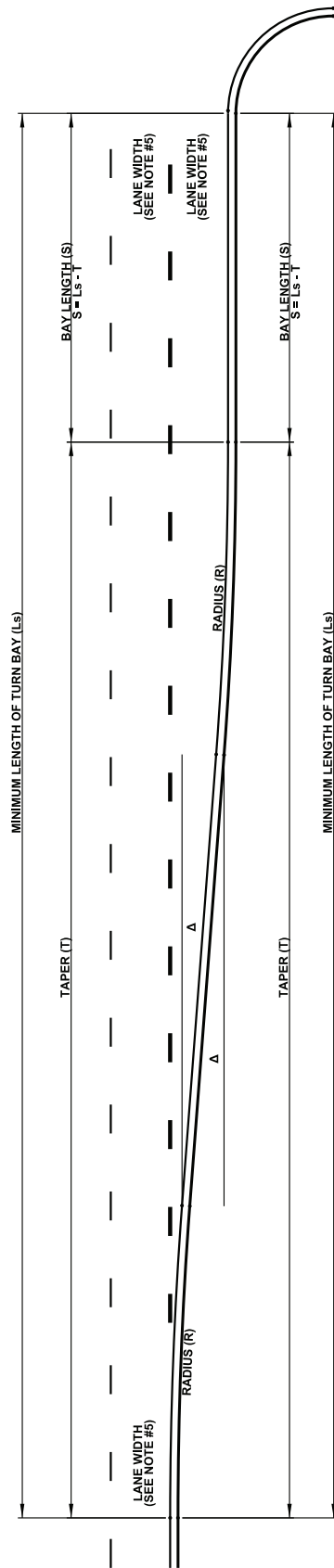

RIGHT TURN BAY DATA					
DESIGN SPEED (km/hr)	T	Ls (MIN.)	R	Δ	TANGENT
50	60.00	90.00	216.68	5°17'00"	10.00
60	60.00	90.00	216.68	5°17'00"	10.00
70	60.00	110.00	216.68	5°17'00"	10.00
80	70.00	130.00	270.64	4°14'00"	10.00

ALL DIMENSIONS IN METRES UNLESS OTHERWISE NOTED

NOTES:

1. ALL RADII ARE TO LIP OF GUTTER.
2. OFFSET DISTANCE ARE TO FACE OF CURB.
3. PAVEMENT MARKINGS ARE TO BE MEASURED FROM FACE OF CURB.
4. LENGTH OF BAY SHALL BE ADJUSTED SUCH THAT STORAGE = BAY LENGTH + 1/2 TAPER = (S) + 1/2 (T)
5. LANE WIDTHS BASED ON CONTEXT, SEE SECTION 3.2.2.3.



STANDARD DRAWING

2023-08-31

RIGHT TURN BAY STANDARD  
ARTERIAL TO ARTERIAL

DATE APPROVED: 2018

SCALE: N.T.S.

DRAWN BY: KSYC

CHECKED BY: JN

APPROVED: *M.R.*

DRAWING NUMBER: 3210

Page 561

v05

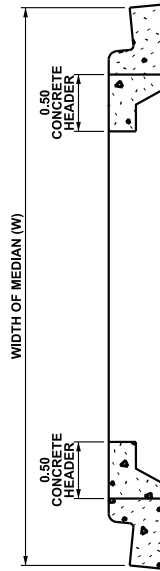
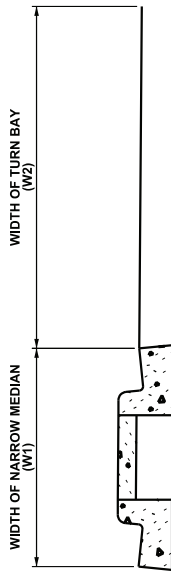
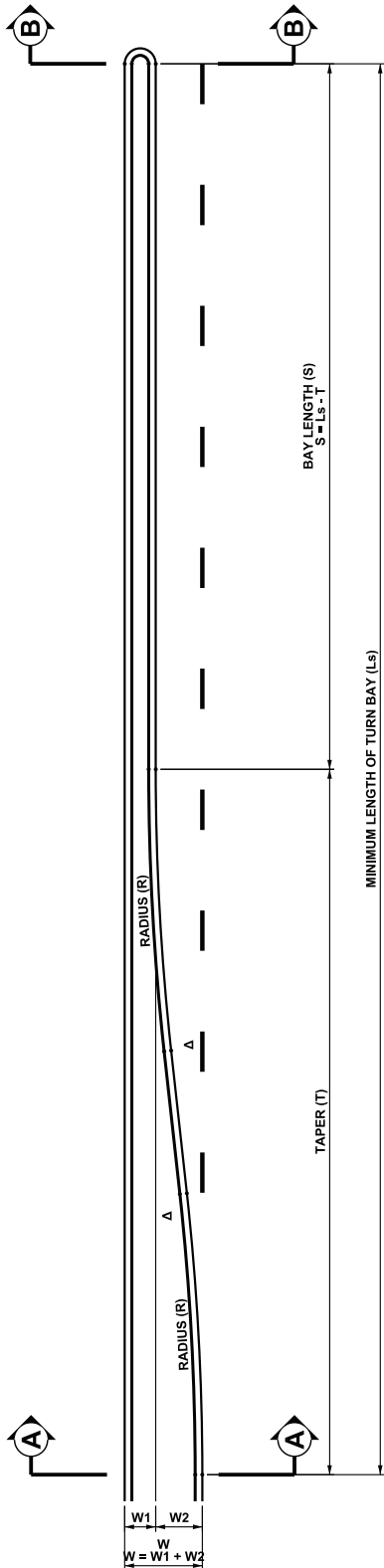

NARROW MEDIAN WIDTH			
0.25 GUTTER (RECOMMENDED)			
DESIGNED WIDTH	W	W1	W2
	5.00	1.70	VARIES

LEFT TURN BAY DATA					
DESIGN SPEED (km/hr)	T	L <sub>s</sub> (MIN.)	R	A	TANGENT
50	60.00	90.00	242.85	4°43'00"	10.00
60	60.00	90.00	242.85	4°43'00"	10.00
70	60.00	110.00	242.85	4°43'00"	10.00
80	70.00	130.00	303.36	3°47'00"	10.00

NOTES:

1. ALL RADII ARE TO LIP OF GUTTER.
2. OFFSET DISTANCE ARE TO FACE OF CURB.
3. PAVEMENT MARKINGS ARE TO BE MEASURED FROM FACE OF CURB.
4. WIDTHS ARE TO BE MEASURED BASED ON 250mm GUTTER. FOR RETROFIT SITUATION (500mm GUTTER):  
 $W1 = 1.2 \times (\text{FACE OF CURB TO FACE OF CURB})$
5. LENGTH OF BAY SHALL BE ADJUSTED SUCH THAT  
 $\text{STORAGE} = \text{BAY LENGTH} + 1/2 \text{ TAPER} = (S) + 1/2 (T)$
6. LANE WIDTHS BASED ON CONTEXT, REFER TO SECTION 3.2.2.3.

ALL DIMENSIONS IN METRES UNLESS OTHERWISE NOTED

LEFT TURN BAY STANDARD NARROW MEDIAN



STANDARD DRAWING

DATE APPROVED: 2018

DRAWN BY: KSYC

APPROVED: *M.R.*

DRAWING NUMBER: 3300

SCALE: N.T.S.

CHECKED BY: JN

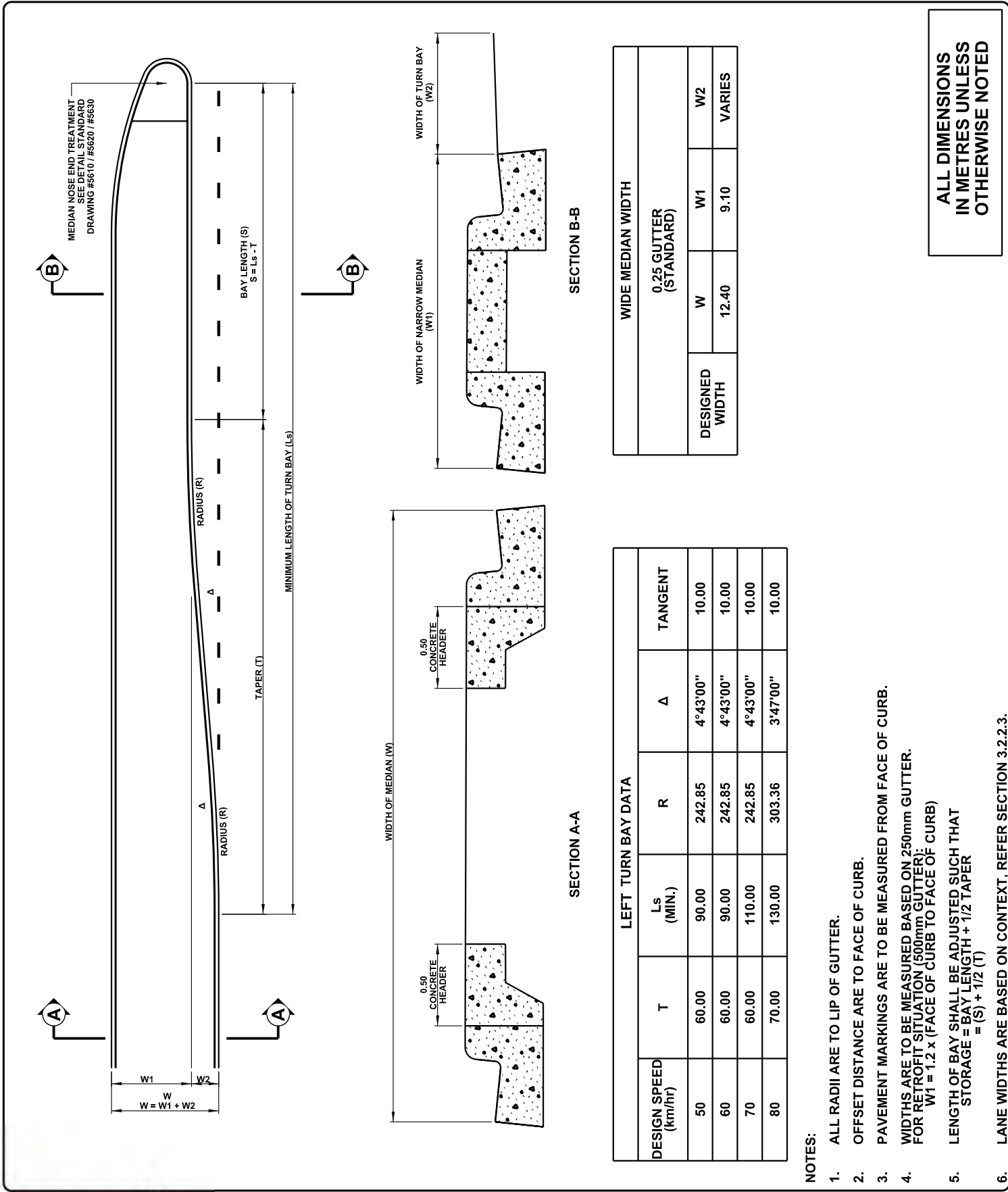

DESIGN SPEED (km/hr)	T	Ls (MIN.)	R	Δ	TANGENT
50	60.00	90.00	242.85	4°43'00"	10.00
60	60.00	90.00	242.85	4°43'00"	10.00
70	60.00	110.00	242.85	4°43'00"	10.00
80	70.00	130.00	303.36	3°47'00"	10.00

0.25 GUTTER (STANDARD)	
DESIGNED WIDTH	W
	12.40
	W1
	9.10
	VARIES
	W2

- NOTES:
1. ALL RADII ARE TO LIP OF GUTTER.
  2. OFFSET DISTANCE ARE TO FACE OF CURB.
  3. PAVEMENT MARKINGS ARE TO BE MEASURED FROM FACE OF CURB.
  4. WIDTHS ARE TO BE MEASURED BASED ON 250mm GUTTER. FOR RETROFIT SITUATION (500mm GUTTER):  
W1 = 1.2 x (FACE OF CURB TO FACE OF CURB)
  5. LENGTH OF BAY SHALL BE ADJUSTED SUCH THAT STORAGE = BAY LENGTH + 1/2 TAPER = (S) + 1/2 (T)
  6. LANE WIDTHS ARE BASED ON CONTEXT. REFER SECTION 3.2.2.3.

ALL DIMENSIONS IN METRES UNLESS OTHERWISE NOTED



**LEFT TURN BAY STANDARD WIDE MEDIAN**

DATE APPROVED: <b>2018</b>	DRAWN BY: <b>KSYC</b>	APPROVED: <i>M.R.</i>	DRAWING NUMBER: <b>3310</b>
SCALE: <b>N.T.S.</b>	CHECKED BY: <b>JN</b>		

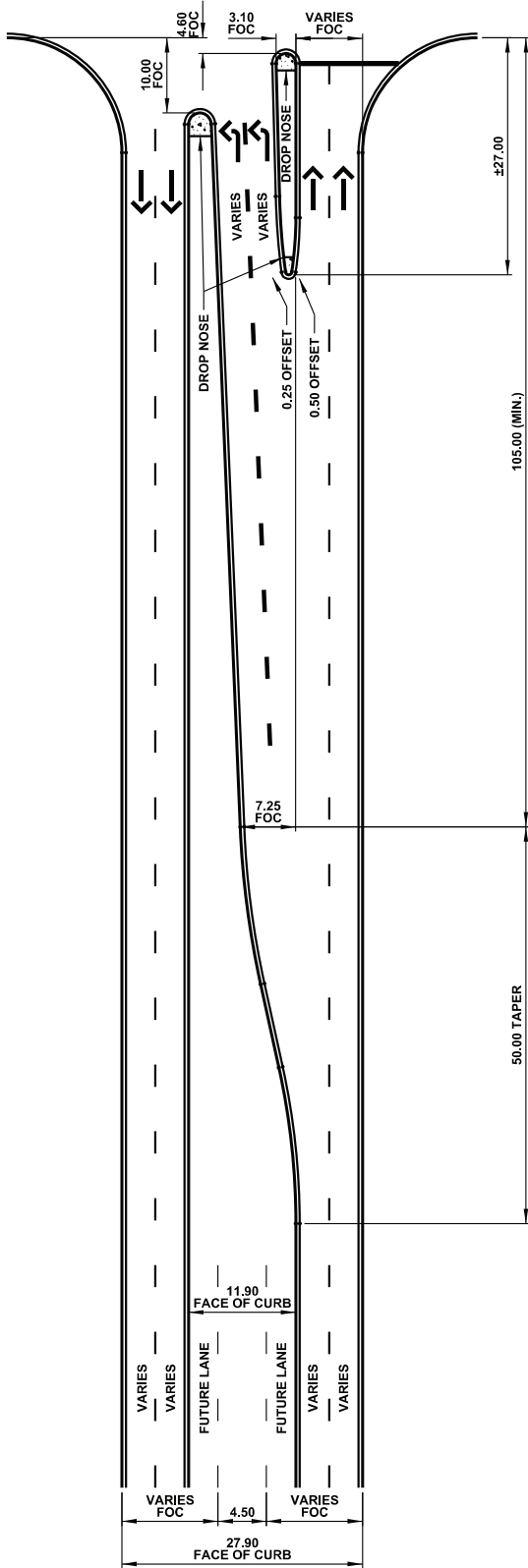

A. TWO LANE

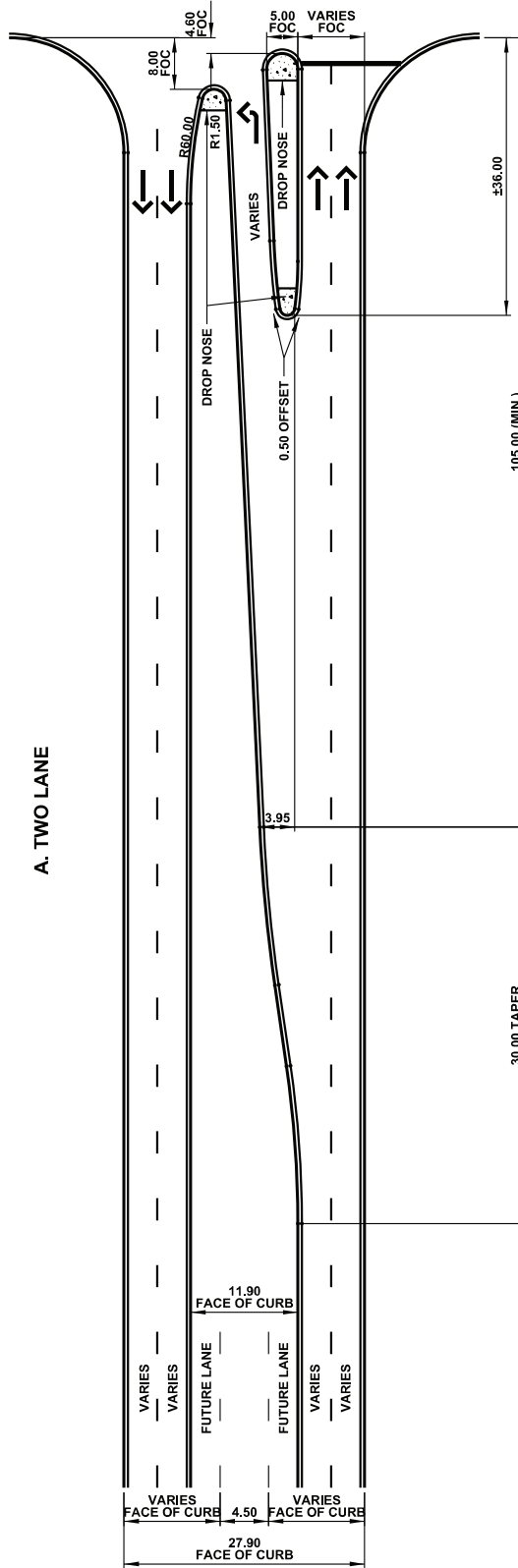

B. ONE LANE

NOTES:

1. MEDIAN WIDTHS ARE BASED ON CURBED MEDIANS.
2. ALL NOSE LOCATIONS SHOULD BE CHECKED WITH TURNING VEHICLE TEMPLATES.
3. CONSTRUCT MEDIAN NOSE END TREATMENT (DRAWING #5610 / #5620 / #5630) WHERE APPLICABLE.
4. LENGTH OF BAY SHALL BE ADJUSTED TO ACCOMMODATE QUEUES SUCH THAT STORAGE = BAY + 1/2 TAPER
5. LANE WIDTHS BASED ON CONTEXT, REFER TO SECTION 3.2.2.3.
6. LANE WIDTH MEASUREMENTS ARE TO FACE OF CURB.
7. ISLAND SETBACK TO BE ADJUSTED BASED ON SIDEWALK LOCATION AND CONFIGURATION.

ALL DIMENSIONS  
IN METRES UNLESS  
OTHERWISE NOTED

LEFT TURN STANDARD  
CHANNELIZED SLOT



STANDARD DRAWING

DATE APPROVED: 2018

DRAWN BY: KSYC

APPROVED: *M.A.R.*

DRAWING NUMBER: 3320

SCALE: N.T.S.

CHECKED BY: JN

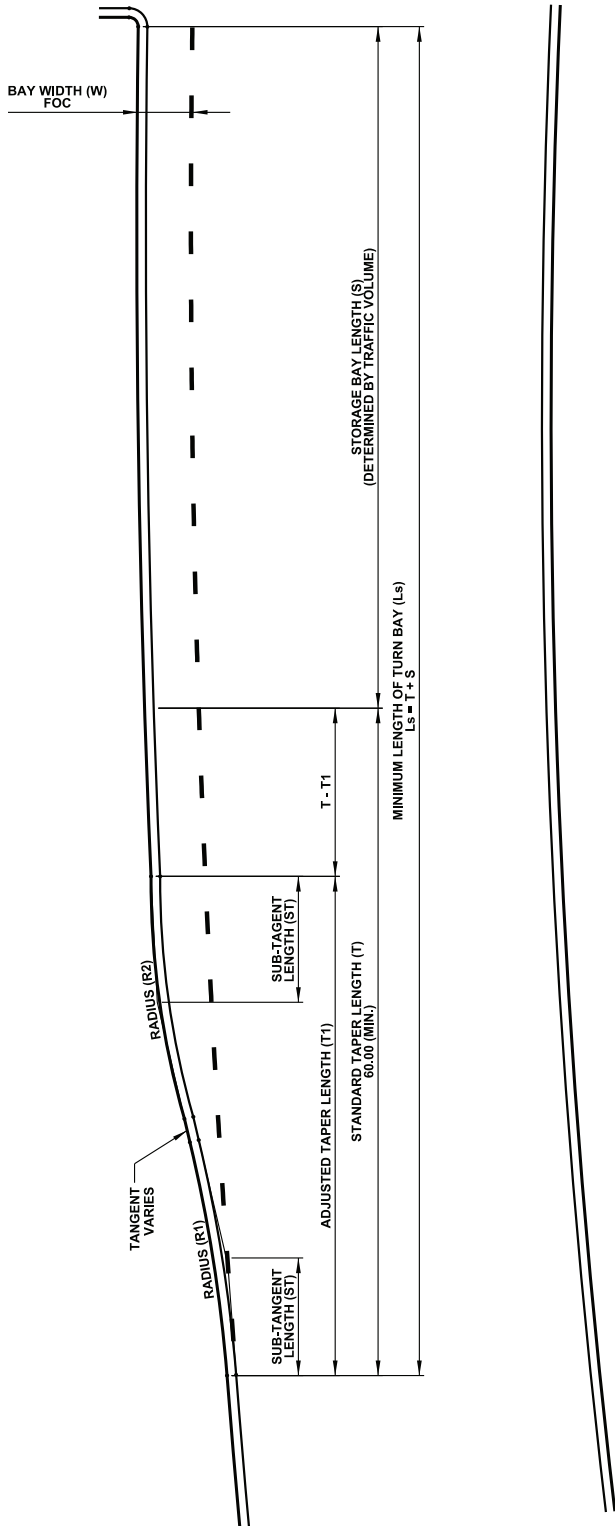

TURN BAY DATA					
DESIGN SPEED (km/hr)	MAIN LINE CURVE DATA (RADIUS)	ADJUSTED TAPER (T1)	SUB-TANGENT (ST)	RADIUS (R1)	RADIUS (R2)
50 - 80	TAN - 1165.00	STANDARD (DWG. 3300)	10.00	VARIES	VARIES
50 - 80	1165.00 - 580.00	35.00	7.00	VARIES	VARIES
50 - 70	580.00 - 350.00	30.00	6.00	VARIES	VARIES
50 - 70	350.00 - 250.00	25.00	5.00	VARIES	VARIES
50 - 60	250.00 - 145.00	20.00	4.00	VARIES	VARIES

NOTES:

1. MINIMUM LENGTH OF TAPER / TURN BAY IS BASED ON STANDARD DESIGN SPEED AND TRAFFIC VOLUME. STANDARD TAPER LENGTH = 60.00 (MIN.).
2. TAPER / BAY WIDTH SEE DRAWING #3300 / #3310.
3. WHERE MAINLINE IS CURVED, TAPER IS REDUCED TO LENGTH SHOWN IN TABLE AND STORAGE LENGTH IS INCREASED BY EQUAL AMOUNT. OVERALL TURN BAY LENGTH DOES NOT CHANGE.

ALL DIMENSIONS  
IN METRES UNLESS  
OTHERWISE NOTED

RIGHT AND LEFT TURN BAY STANDARD  
CURVED MAIN LINE



STANDARD DRAWING

DATE APPROVED: 2018

DRAWN BY: KSYC

APPROVED: *M.R.*

DRAWING NUMBER: 3350

SCALE: N.T.S.

CHECKED BY: JN

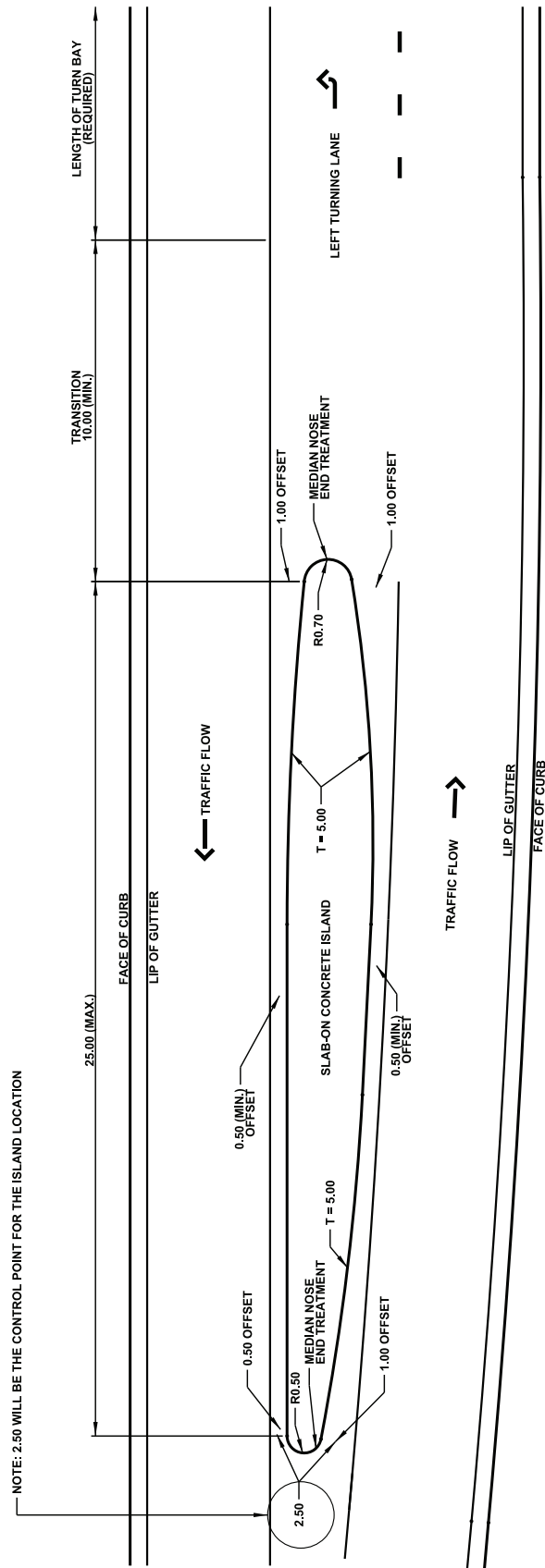

ALL DIMENSIONS  
IN METRES UNLESS  
OTHERWISE NOTED

ISLAND LAYOUT  
FOR  
INTRODUCTION OF CHANNELIZATION



STANDARD DRAWING

DATE APPROVED: **2018**

DRAWN BY: **KSYC**

APPROVED: *M.R.*

DRAWING NUMBER: **3400**

SCALE: **N.T.S.**

CHECKED BY: **JN**

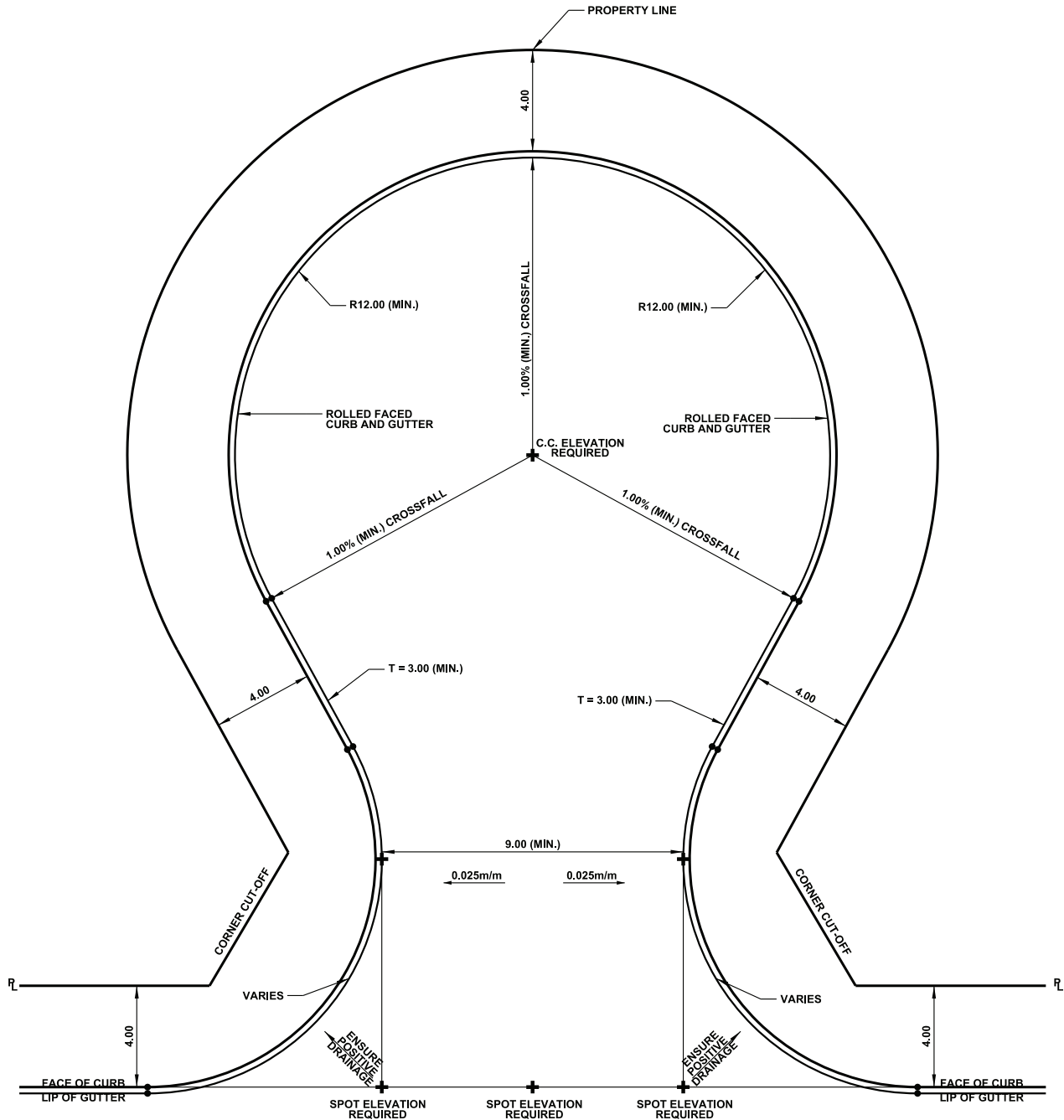

**NOTES:**

1. PROVIDE ELEVATION FOR ALL CROSS SYMBOL (+) SHOWN.
2. 1.00% (MIN.) LONGITUDINAL GRADE REQUIRED ALONG CUL-DE-SAC AND CURB RADII.
3. ALL RADII ARE TO LIP OF GUTTER.

**ALL DIMENSIONS  
IN METRES UNLESS  
OTHERWISE NOTED**



**Edmonton**

STANDARD DRAWING

**RESIDENTIAL CUL-DE-SAC  
(WITHOUT ISLAND)**

DATE APPROVED: **2018**

SCALE: **N.T.S.**

DRAWN BY: **KSYC**

CHECKED BY: **JN**

APPROVED: *M.A.R.*

DRAWING NUMBER: **3500**

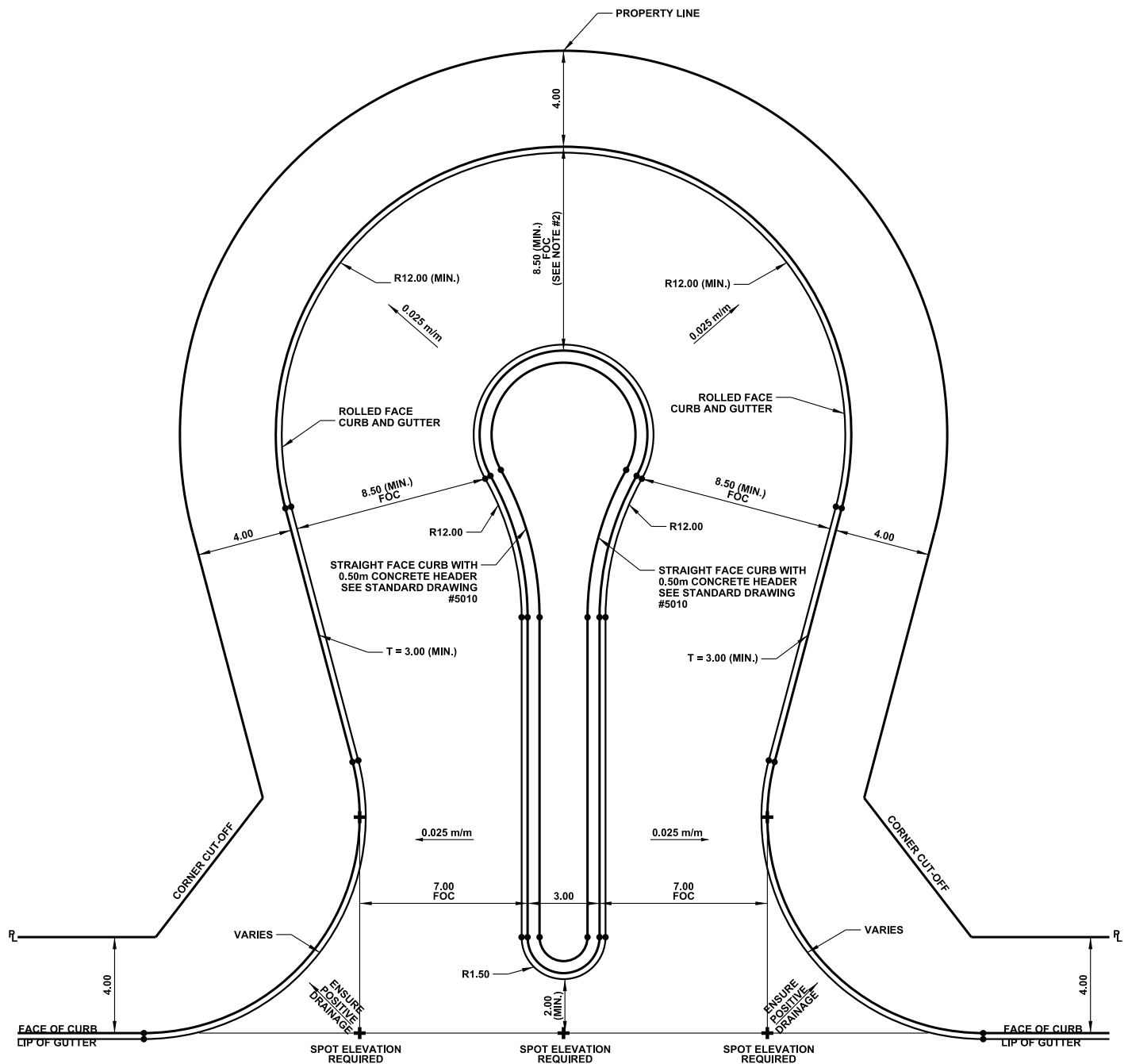

**NOTES:**

1. PROVIDE ELEVATION FOR ALL CROSS SYMBOL (+) SHOWN.
2. CROSSFALL ON NOSE MAY BE REDUCED TO 0.01m/m (MIN.) TO FACILITATE GRADES.
3. 1.00% (MIN.) LONGITUDINAL GRADE REQUIRED ALONG CUL-DE-SAC AND CURB RADII.
3. ALL RADII ARE TO LIP OF GUTTER.
4. PROVISION ALLOTTED FOR PARALLEL PARKING AROUND 12.00m RADIUS. NO PARKING ON INSIDE CURBLINE.
5. CONCRETE HEADER TO BE POURED MONOLITHICALLY WITH CURB AND GUTTER.

**ALL DIMENSIONS  
IN METRES UNLESS  
OTHERWISE NOTED**



STANDARD DRAWING

2023-08-31

**RESIDENTIAL CUL-DE-SAC  
(CIRCULAR ISLAND)**

DATE APPROVED: **2018**

DRAWN BY: **KSYC**

APPROVED: *M.R.*

DRAWING NUMBER: **3510**

SCALE: **N.T.S.**

CHECKED BY: **JN**

v05



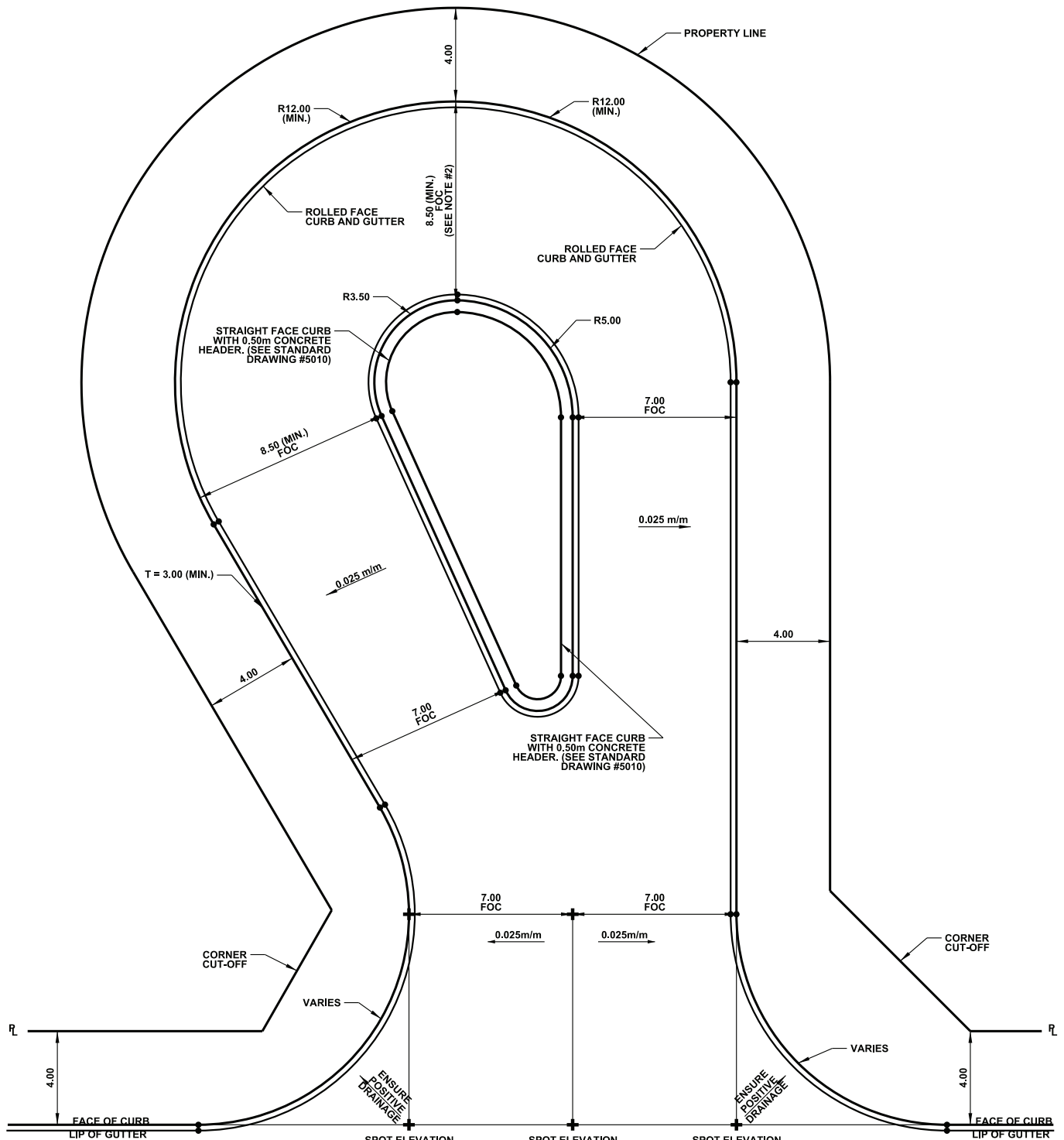

**NOTES:**

1. PROVIDE ELEVATION FOR ALL CROSS SYMBOL (+) SHOWN.
2. CROSSFALL MAY BE REDUCED TO 0.01m/m (MIN.) TO FACILITATE GRADES.
3. 1.00% (MIN.) LONGITUDINAL GRADE REQUIRED ALONG CUL-DE-SAC AND CURB RADII.
3. ALL RADII ARE TO LIP OF GUTTER.
4. PROVISION ALLOTTED FOR PARALLEL PARKING AROUND 12.00m RADIUS. NO PARKING ON INSIDE CURBLINE.
5. CONCRETE HEADER ARE TO BE POURED MONOLITHICALLY WITH CURB AND GUTTER.

**ALL DIMENSIONS  
IN METRES UNLESS  
OTHERWISE NOTED**



**RESIDENTIAL CUL-DE-SAC  
(CIRCULAR OFFSET ISLAND)**

DATE APPROVED: <b>2018</b>	DRAWN BY: <b>KSYC</b>	APPROVED: <i>M.A.R.</i>	DRAWING NUMBER: <b>3520</b>
SCALE: <b>N.T.S.</b>	CHECKED BY: <b>JN</b>		

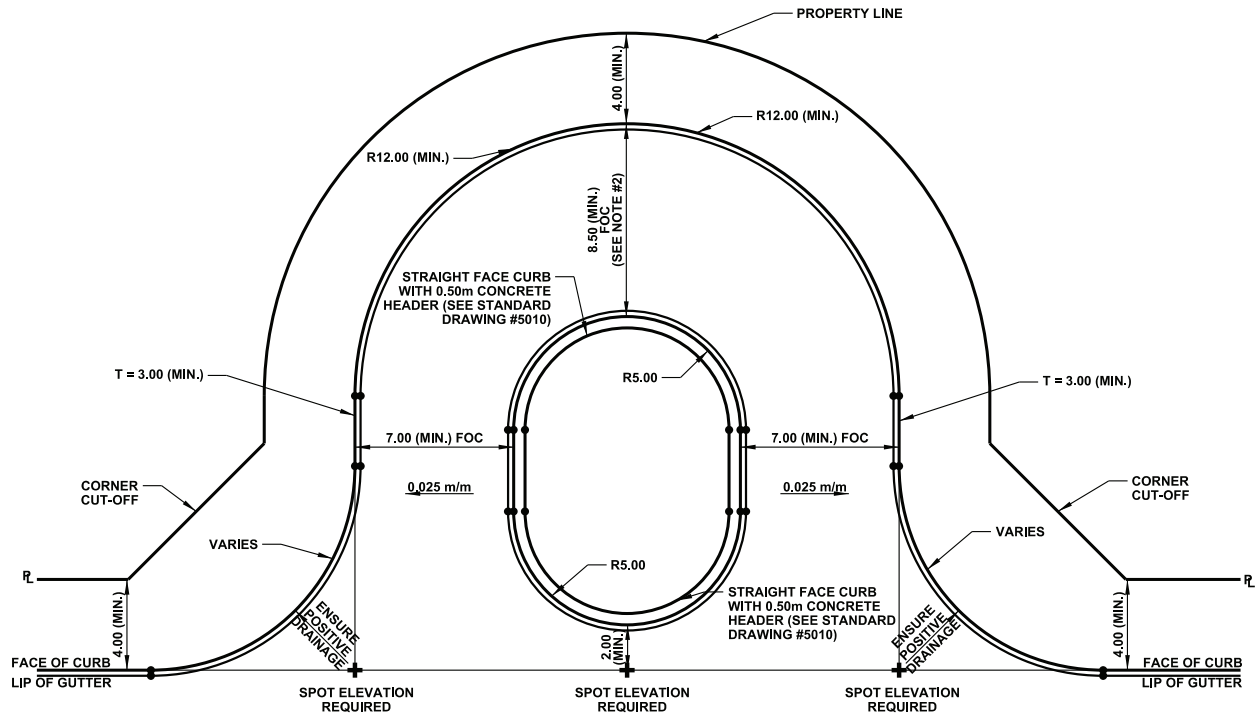

**NOTES:**

1. PROVIDE ELEVATION FOR ALL CROSS SYMBOL (+) SHOWN.
2. CROSSFALL ON NOSE MAY BE REDUCED TO 0.01m/m (MIN.) TO FACILITATE GRADES.
3. 1.00% (MIN.) LONGITUDINAL GRADE REQUIRED ALONG CUL-DE-SAC AND CURB RADII.
3. ALL RADII ARE TO LIP OF GUTTER.
4. PROVISION ALLOTTED FOR PARALLEL PARKING AROUND 10.25m RADIUS. NO PARKING ON INSIDE CURBLINE.
5. CONCRETE HEADER ARE TO BE POURED MONOLITHICALLY WITH CURB AND GUTTER.

**ALL DIMENSIONS  
IN METRES UNLESS  
OTHERWISE NOTED**



**Edmonton**  
STANDARD DRAWING

**RESIDENTIAL CUL-DE-SAC  
(CIRCULAR ISLAND)**

DATE APPROVED: **2018**  
SCALE: **N.T.S.**

DRAWN BY: **KSYC**  
CHECKED BY: **JN**

APPROVED: *M.R.*

DRAWING NUMBER: **3530**

**POINTS FROM WHERE MEASUREMENTS ARE TO BE TAKEN**  
**TO DETERMINE SIDEWALK REQUIREMENTS**  
**FOR CULS-DE-SAC WITH NO WALKWAY CONNECTIONS**

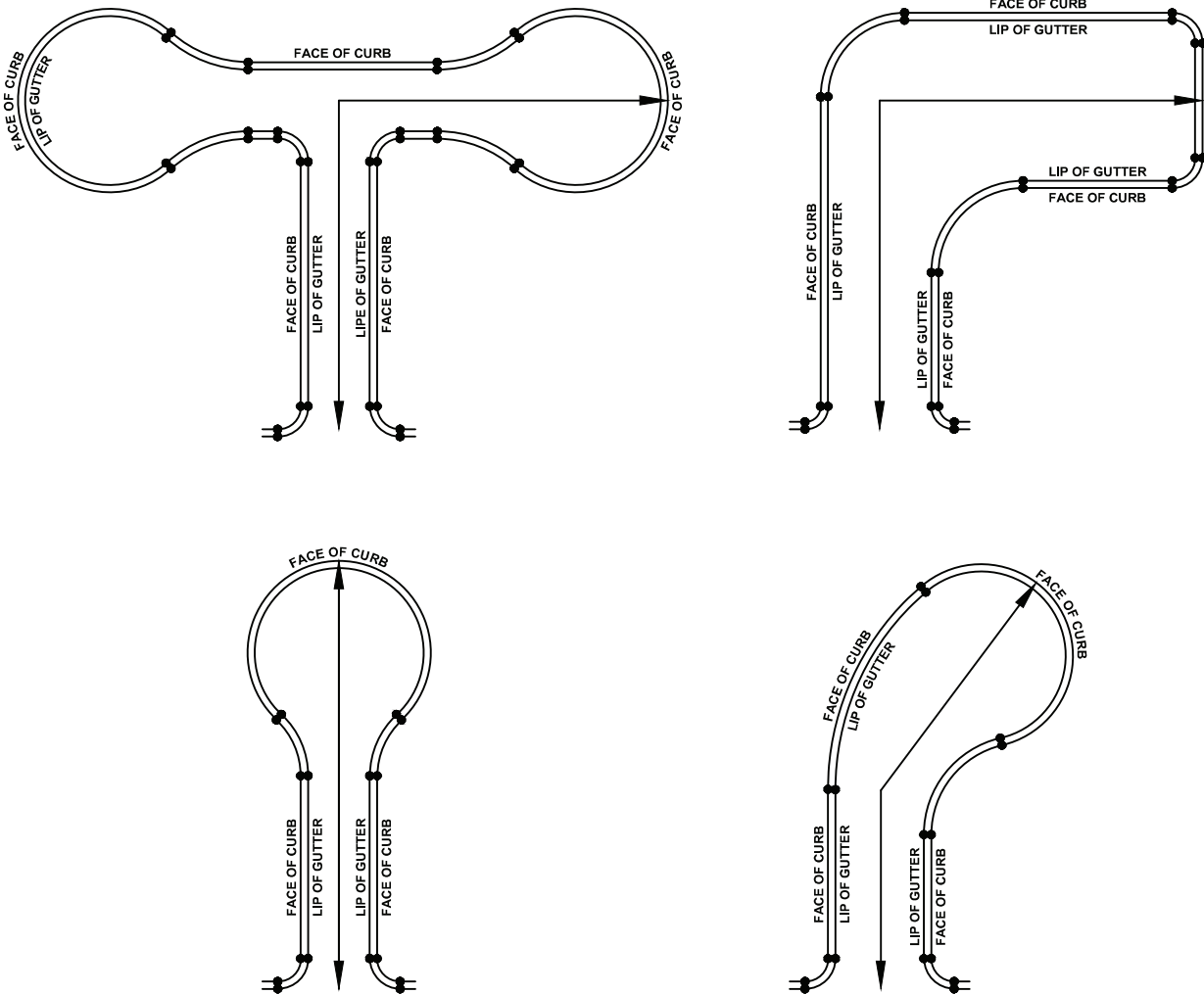

**NOTES:**

**WALKWAYS WILL BE REQUIRED IN CUL-DE-SAC AS DESCRIBED BELOW.**

- CUL-DE-SAC WITH 10 OR FEWER LOTS FRONTING AND/OR FLANKING THE CUL-DE-SAC DOES NOT REQUIRE SIDEWALK.
- CUL-DE-SAC WITH FEWER THAN 19 LOTS AND LESS THAN 120.00m ONLY REQUIRES SIDEWALK ON ONE SIDE. (\*)
- CUL-DE-SAC WITH 19 LOTS OR MORE FRONTING AND/OR FLANKING WILL REQUIRE SIDEWALK ON BOTH SIDES.
- CUL-DE-SAC WITH WALKWAY CONNECTION TO WALK OR TRAIL SYSTEM WILL REQUIRE SIDEWALK ON BOTH SIDES.

(\*) APPLICATIONS FOR SIDEWALK ON ONE-SIDE FOR CUL-DE-SAC WITH FEWER THAN 19 LOTS ARE DISCRETIONARY. FURTHER INFORMATION ON LAND USE/ZONING ARE REQUIRED.

**SIDEWALK REQUIREMENTS  
CUL-DE-SAC**



STANDARD DRAWING

DATE APPROVED: **2018**

DRAWN BY: **KSYC**

APPROVED: *M.A.R.*

DRAWING NUMBER: **3540**

SCALE: **N.T.S.**

CHECKED BY: **JN**

NOTE:

1. ALL DIMENSIONS ARE TO FACE OF CURB
2. USE OF NEIGHBOURHOOD TRAFFIC CIRCLES TO BE COORDINATED WITH WASTE MANAGEMENT AND EMERGENCY SERVICES FOR ROUTING
3. ALL SIGNAGE AND PAVEMENT MARKINGS TO FOLLOW MUTCDC
4. CROSSWALK PLACEMENT TO BE OUTSIDE OF DESIGN VEHICLE PATH OR PASSENGER VEHICLE PATH, WHICHEVER IS GREATER

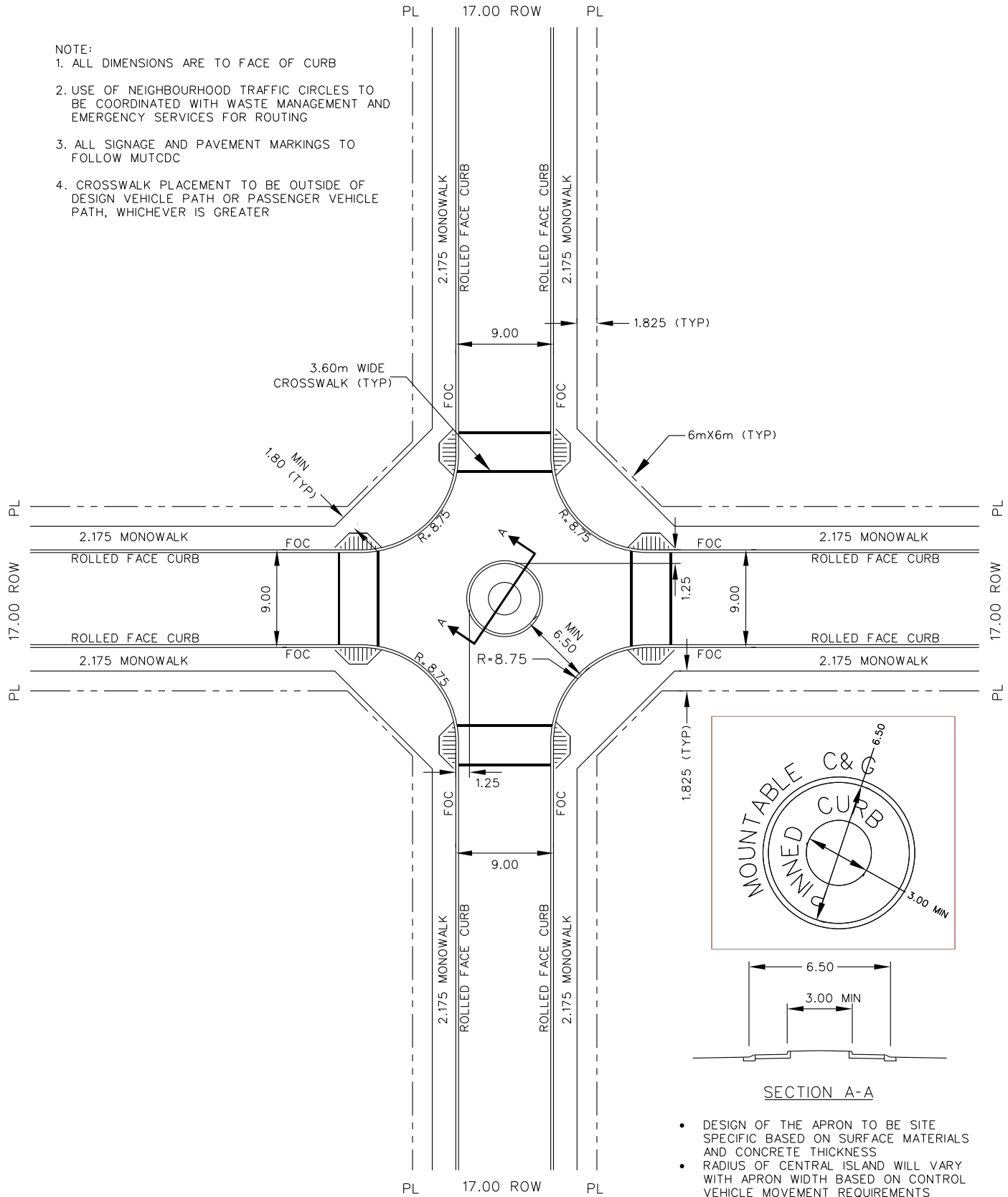

- DESIGN OF THE APRON TO BE SITE SPECIFIC BASED ON SURFACE MATERIALS AND CONCRETE THICKNESS
- RADIUS OF CENTRAL ISLAND WILL VARY WITH APRON WIDTH BASED ON CONTROL VEHICLE MOVEMENT REQUIREMENTS

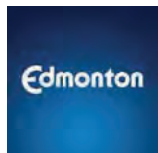

STANDARD DRAWING

2023-08-31

**NEIGHBORHOOD TRAFFIC CIRCLE**  
**9m URBAN LOCAL x 9m URBAN LOCAL**

DATE APPROVED: **2018**

SCALE: **N.T.S.**

DRAWN BY: **KSYC**

CHECKED BY: **JN**

APPROVED: *M.L.R.*

DRAWING NUMBER: **3700**

Page 572

v05

NOTES:

1. ALL DIMENSIONS ARE TO FACE OF CURB
2. RAISED CENTRAL ISLAND SIZE BASED OFF AN AERIAL FIRETRUCK TURNING MOVEMENT
3. IF ACCOMODATING VEHICLES GREATER THAN AN AERIAL FIRETRUCK, DESIGN OF RAISED CENTRAL ISLAND NEEDS TO BE VERIFIED
4. ELEPHANT FEET MARKINGS TO BE 0.4m x 0.4m WHITE SQUARES SPACED 0.4m APART
5. INSTALL YIELD SIGN FACING SHARED USE PATHWAY WHEN INSTALLING BICYCLE CROSSING (ELEPHANT FEET) PAVEMENT MARKINGS (TYP)
6. ALL SIGNAGE AND PAVEMENT MARKINGS TO FOLLOW MUTCDC

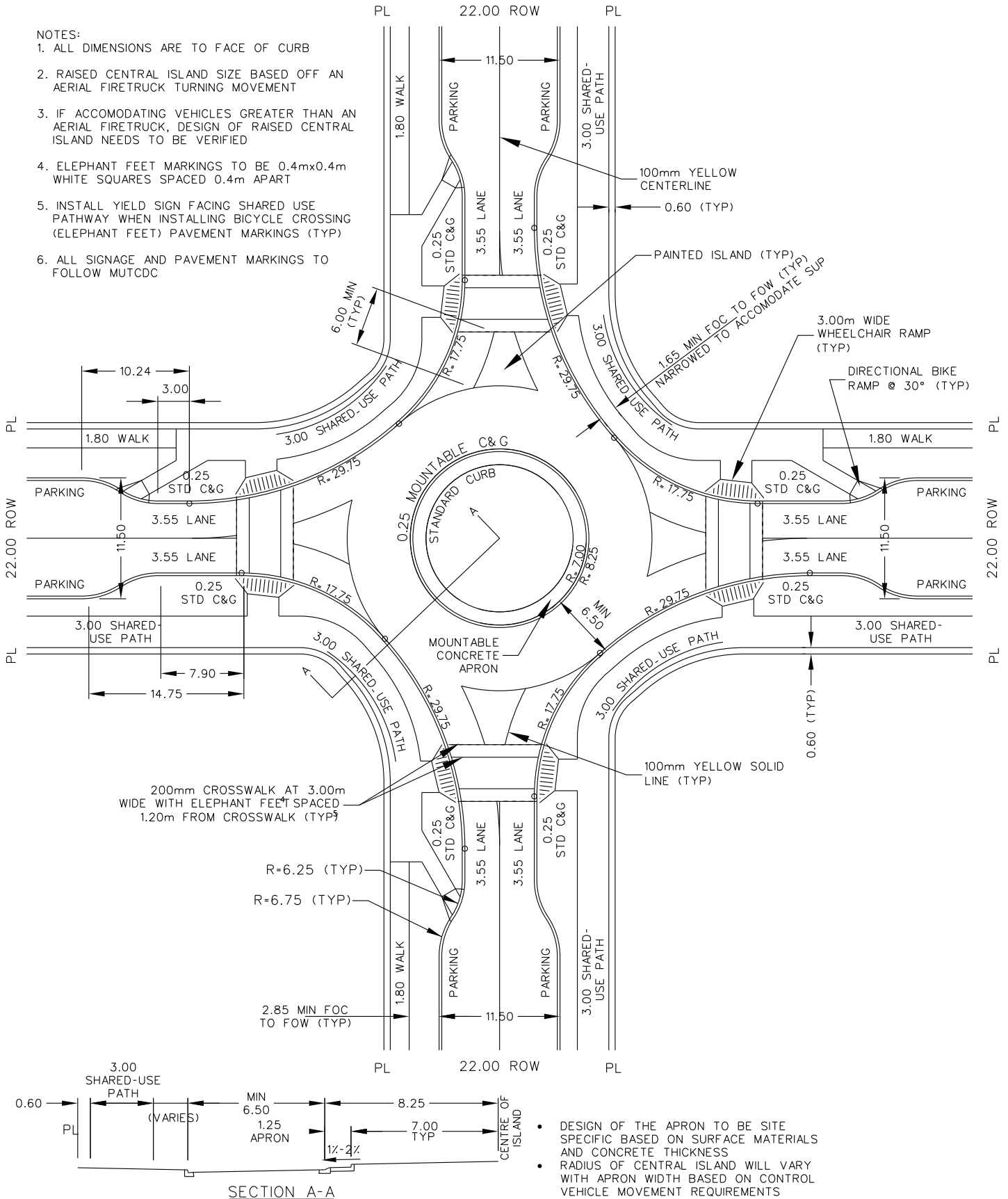

- DESIGN OF THE APRON TO BE SITE SPECIFIC BASED ON SURFACE MATERIALS AND CONCRETE THICKNESS
- RADIUS OF CENTRAL ISLAND WILL VARY WITH APRON WIDTH BASED ON CONTROL VEHICLE MOVEMENT REQUIREMENTS

SECTION A-A



STANDARD DRAWING

2023-08-31

**MINI ROUNDABOUT**  
**11.5m URBAN COLLECTOR x 11.5m URBAN COLLECTOR**  
**WITH SHARED-USE PATH AND ON-STREET BIKE LANE**

DATE APPROVED: **2018**  
 SCALE: **N.T.S.**

DRAWN BY: **KSYC**  
 CHECKED BY: **JN**

APPROVED: *M.A.R.*

DRAWING NUMBER: **3710**

NOTES:

1. ALL DIMENSIONS ARE TO FACE OF CURB
2. ELEPHANT FEET MARKINGS TO BE 0.4m x 0.4m WHITE SQUARES SPACED 0.4m APART
3. INSTALL YIELD SIGN FACING SHARED USE PATHWAY WHEN INSTALLING BICYCLE CROSSING (ELEPHANT FEET) PAVEMENT MARKINGS (TYP)
4. ALL SIGNAGE AND PAVEMENT MARKINGS TO FOLLOW MUTCDC
5. NO VERTICAL OBSTRUCTIONS TO BE INSTALLED ON SPLITTER ISLANDS

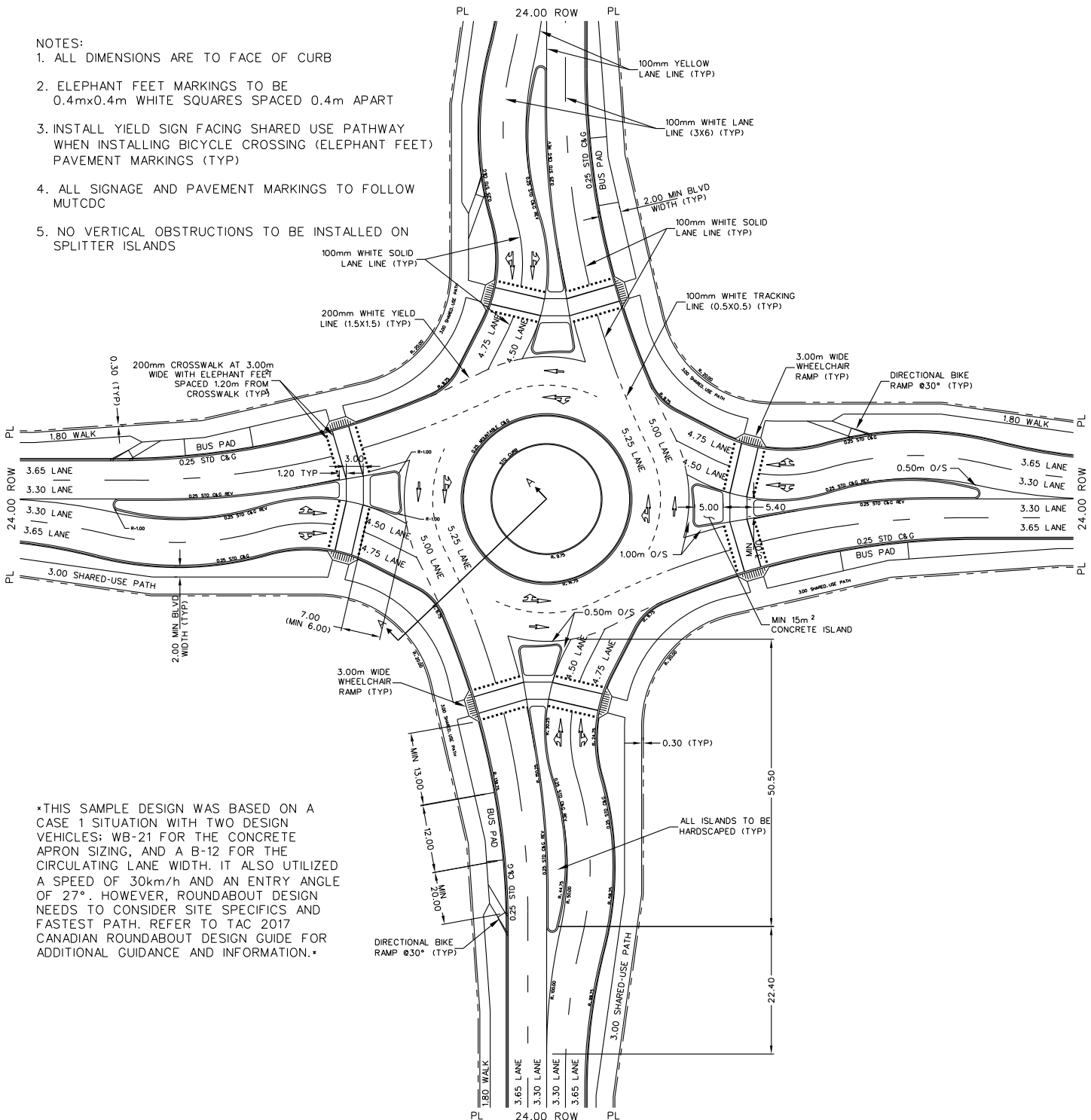

\*THIS SAMPLE DESIGN WAS BASED ON A CASE 1 SITUATION WITH TWO DESIGN VEHICLES: WB-21 FOR THE CONCRETE APRON SIZING, AND A B-12 FOR THE CIRCULATING LANE WIDTH. IT ALSO UTILIZED A SPEED OF 30km/h AND AN ENTRY ANGLE OF 27°. HOWEVER, ROUNDABOUT DESIGN NEEDS TO CONSIDER SITE SPECIFICS AND FASTEST PATH. REFER TO TAC 2017 CANADIAN ROUNDABOUT DESIGN GUIDE FOR ADDITIONAL GUIDANCE AND INFORMATION.\*

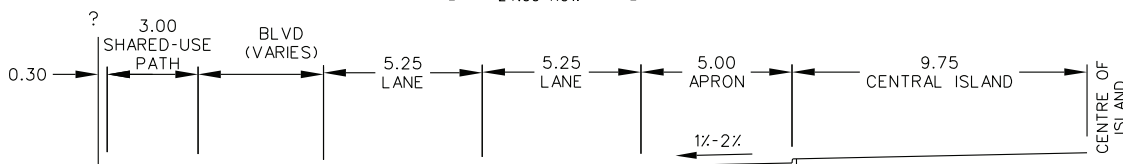

SECTION A-A

- DESIGN OF THE APRON TO BE SITE SPECIFIC BASED ON SURFACE MATERIALS AND CONCRETE THICKNESS
- RADIUS OF CENTRAL ISLAND WILL VARY WITH APRON WIDTH BASED ON CONTROL VEHICLE MOVEMENT REQUIREMENTS



STANDARD DRAWING

2023-08-31

DATE APPROVED:

2018

SCALE:

N.T.S.

DRAWN BY:

KSYC

CHECKED BY:

JN

APPROVED:

*M.A.R.*

DRAWING NUMBER:

3720

v05

Page 574

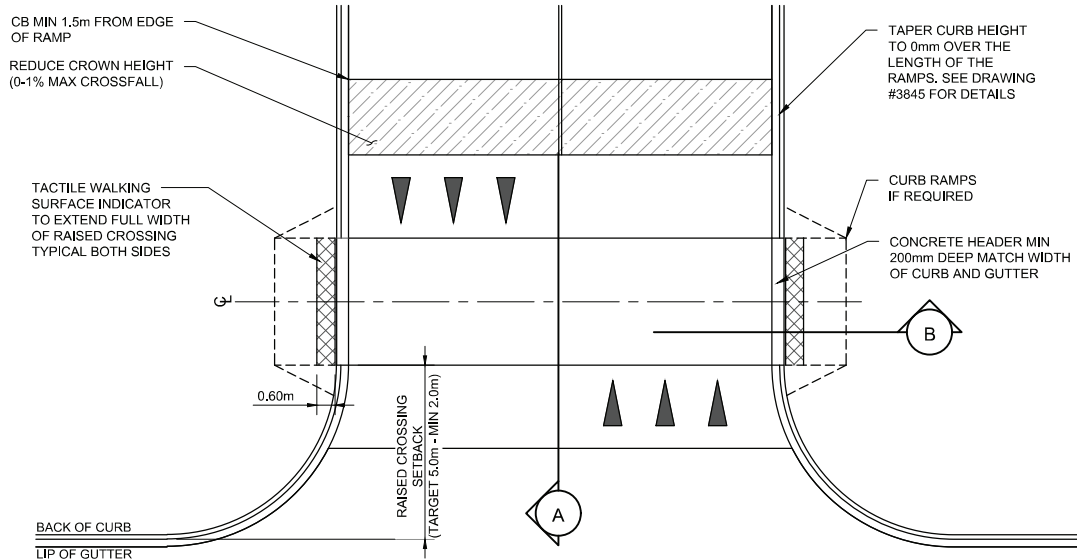

PLAN

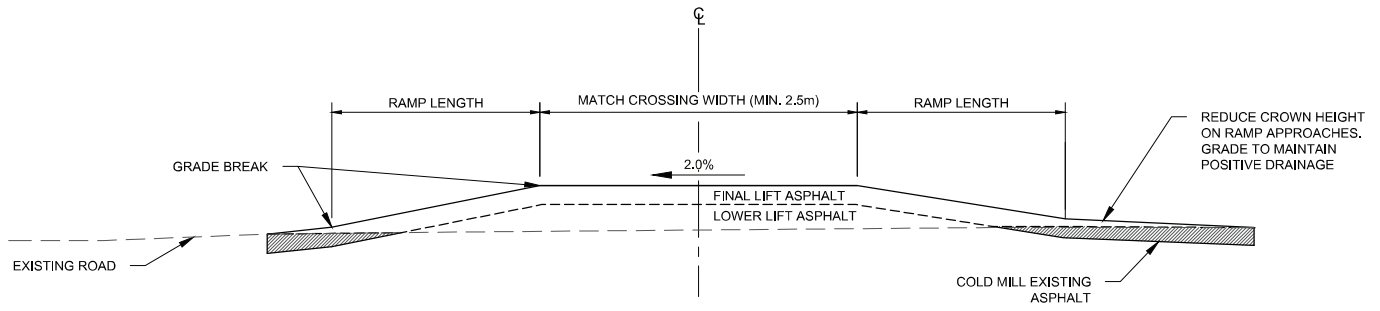

SECTION A

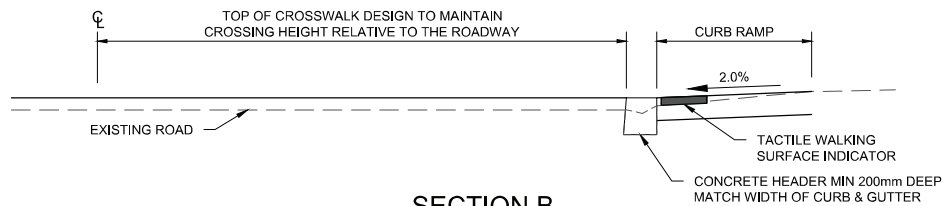

SECTION B

- NOTES:**
- SUPPLEMENTAL SIGNAGE AND PAINT MARKINGS AS PER LATEST EDITION OF THE CITY OF EDMONTON MANUAL FOR PAVEMENT MARKING DESIGN, AND THE MANUAL FOR UNIFORM TRAFFIC CONTROL DEVICES OF CANADA. MARKINGS TO BE CONFIRMED BY ENGINEER
  - MAY REQUIRE CHANGES TO DRAINAGE DESIGN

- NOTES:**
- MINIMUM CROSSING WIDTH 2.50m
  - WIDTH OF RAISED CROSSING SHOULD MATCH WIDTH OF CROSSWALK/SIDEWALK, SHARED USED PATH, BIKE PATH AND/OR RAISED PROTECTED BIKE LANE
  - SEE SECTION 2.3 FOR RAMP LENGTH AND GRADE BREAK REQUIREMENTS

**ALL DIMENSIONS  
 IN MILLIMETRES UNLESS  
 OTHERWISE NOTED**

**RAISED CROSSING AT INTERSECTION -  
 ASPHALT (RETROFIT)**



STANDARD DRAWING

DATE APPROVED: **2023**

DRAWN BY: **MT**

APPROVED: *Cherie Fuchs*

DRAWING NUMBER: **3800**

SCALE: **N.T.S.**

CHECKED BY: **MB**

DocuSign ID: 8142241F722822008

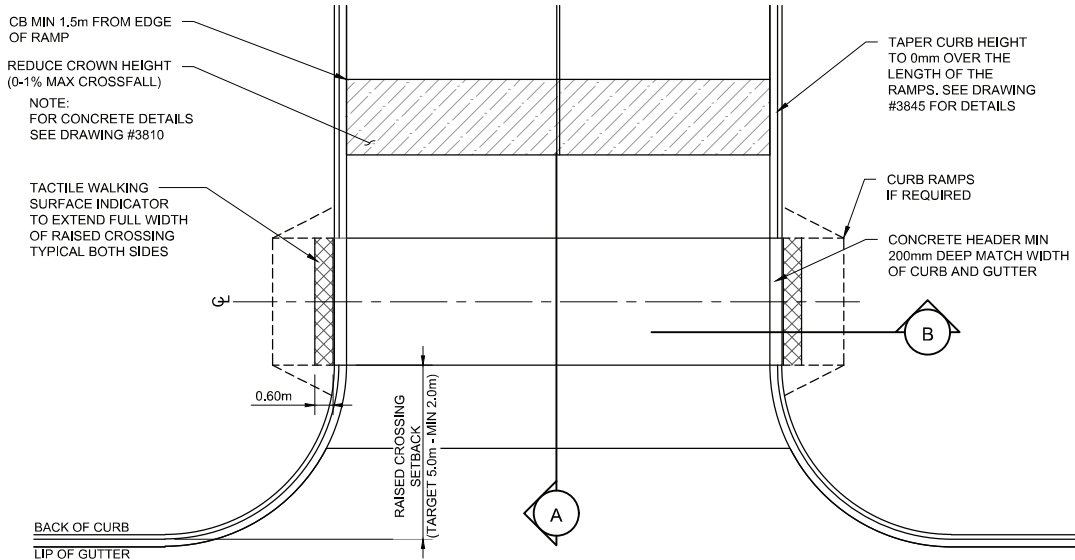

PLAN

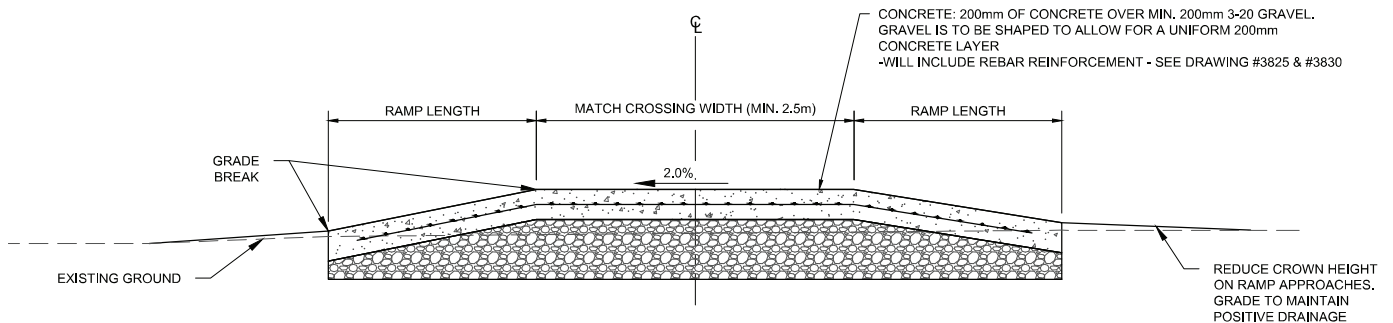

SECTION A

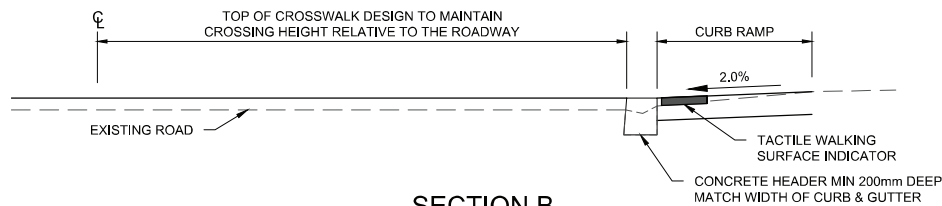

SECTION B

- NOTES:**
- SUPPLEMENTAL SIGNAGE AND PAINT MARKINGS AS PER LATEST EDITION OF THE CITY OF EDMONTON MANUAL FOR PAVEMENT MARKING DESIGN, AND THE MANUAL FOR UNIFORM TRAFFIC CONTROL DEVICES OF CANADA. MARKINGS TO BE CONFIRMED BY ENGINEER
  - MAY REQUIRE CHANGES TO DRAINAGE DESIGN

- NOTES:**
- MINIMUM CROSSING WIDTH 2.50m
  - WIDTH OF RAISED CROSSING SHOULD MATCH WIDTH OF CROSSWALK/SIDEWALK, SHARED USED PATH, BIKE PATH AND/OR RAISED PROTECTED BIKE LANE
  - SEE SECTION 2.3 FOR RAMP LENGTH AND GRADE BREAK REQUIREMENTS

**ALL DIMENSIONS  
 IN MILLIMETRES UNLESS  
 OTHERWISE NOTED**

**RAISED CROSSING AT INTERSECTION - CONCRETE**



STANDARD DRAWING

DATE APPROVED: **2023**

SCALE: **N.T.S.**

DRAWN BY: **MT**

CHECKED BY: **MB**

APPROVED: *Cherie Fuchs*

DRAWING NUMBER:

**3805**



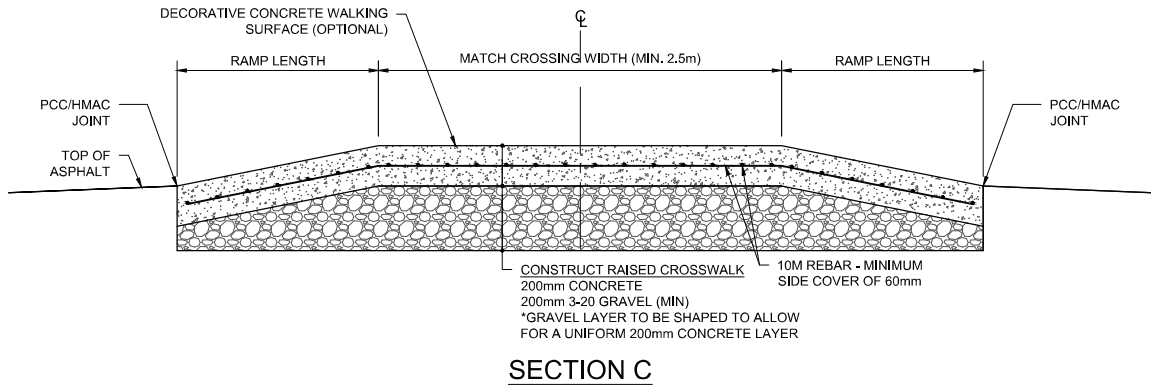
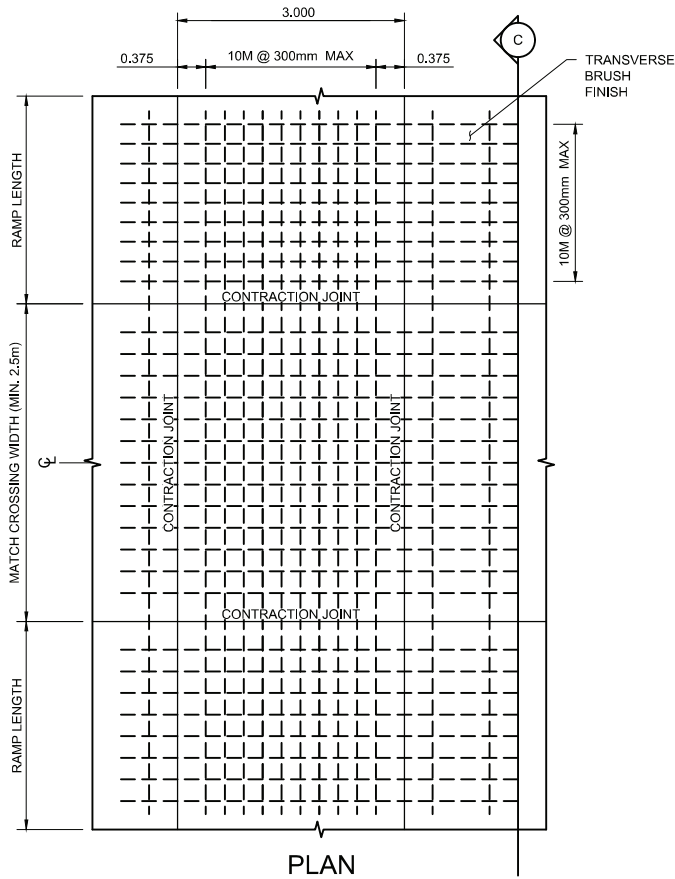

- NOTES:**
- SUPPLEMENTAL SIGNAGE AND PAINT MARKINGS AS PER LATEST EDITION OF THE CITY OF EDMONTON MANUAL FOR PAVEMENT MARKING DESIGN, AND THE MANUAL FOR UNIFORM TRAFFIC CONTROL DEVICES OF CANADA. MARKINGS TO BE CONFIRMED BY ENGINEER
  - MAY REQUIRE CHANGES TO DRAINAGE DESIGN

- NOTES:**
- MINIMUM CROSSING WIDTH 2.50m
  - WIDTH OF RAISED CROSSING SHOULD MATCH WIDTH OF CROSSWALK/SIDEWALK, SHARED USED PATH, BIKE PATH AND/OR RAISED PROTECTED BIKE LANE
  - SEE SECTION 2.3 FOR RAMP LENGTH AND GRADE BREAK REQUIREMENTS

**ALL DIMENSIONS  
 IN MILLIMETRES UNLESS  
 OTHERWISE NOTED**



## CONCRETE DETAILS - RAISED CROSSING

DATE APPROVED: **2023**  
 SCALE: **N.T.S.**

DRAWN BY: **MT**  
 CHECKED BY: **MB**

APPROVED:  
 Designed by: *Cherie Fuchs*

DRAWING NUMBER:  
**3810**

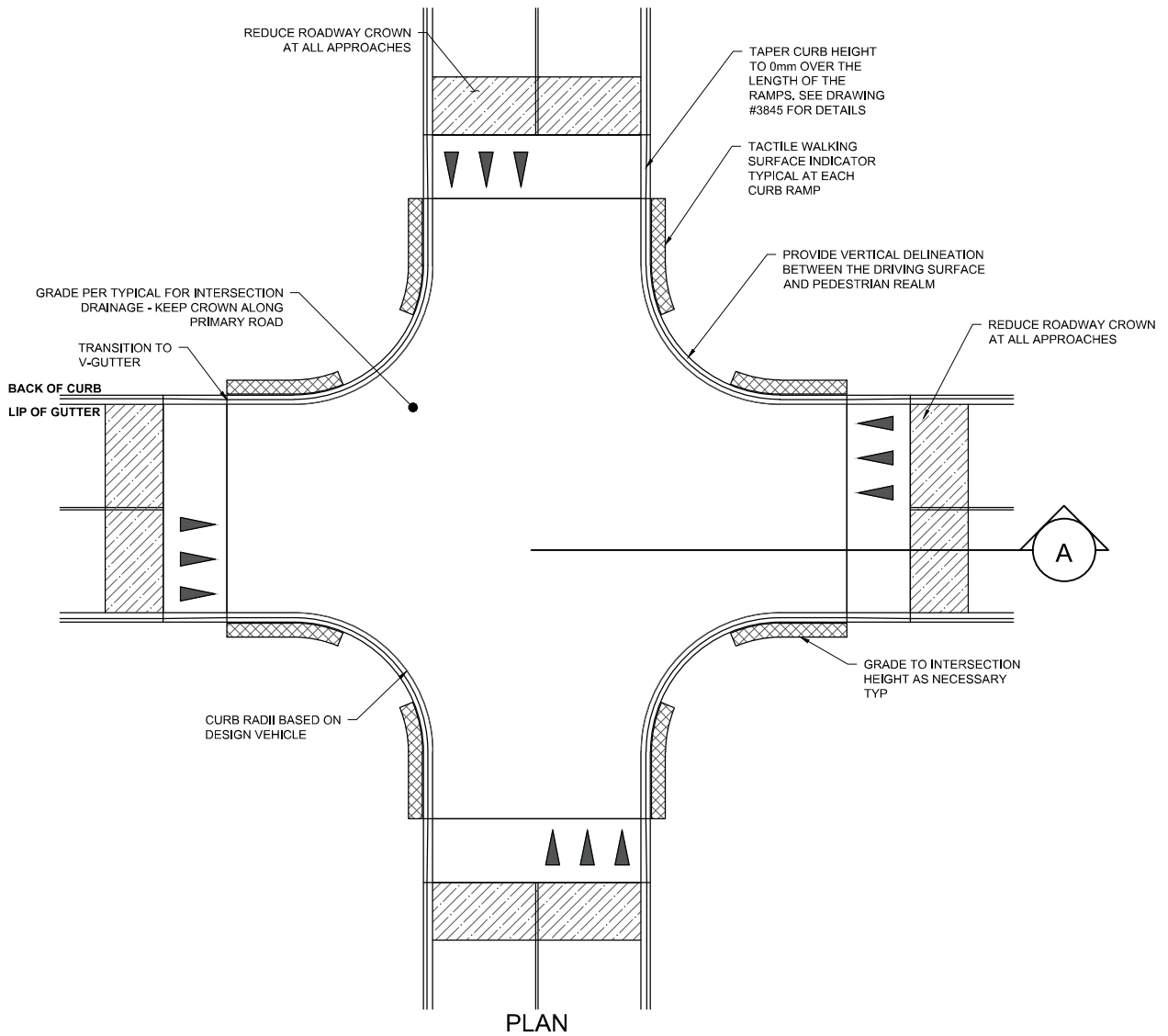

PLAN

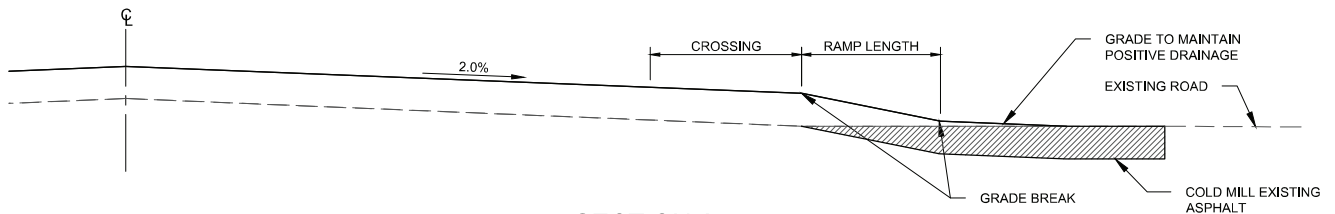

SECTION A

- NOTES:**
- SUPPLEMENTAL SIGNAGE AND PAINT MARKINGS AS PER LATEST EDITION OF THE CITY OF EDMONTON MANUAL FOR PAVEMENT MARKING DESIGN, AND THE MANUAL FOR UNIFORM TRAFFIC CONTROL DEVICES OF CANADA. MARKINGS TO BE CONFIRMED BY ENGINEER
  - MAY REQUIRE CHANGES TO DRAINAGE DESIGN

- NOTES:**
- SEE SECTION 2.3 FOR RAMP LENGTH AND GRADE BREAK REQUIREMENTS

**ALL DIMENSIONS  
 IN MILLIMETRES UNLESS  
 OTHERWISE NOTED**

**RAISED INTERSECTION - ASPHALT**



STANDARD DRAWING

DATE APPROVED: **2023**

DRAWN BY: **MT**

APPROVED: *Cherie Fuchs*

DRAWING NUMBER: **3815**

SCALE: **N.T.S.**

CHECKED BY: **MB**

1742017220000...

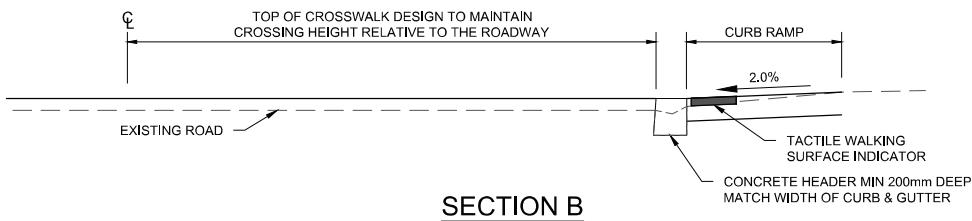
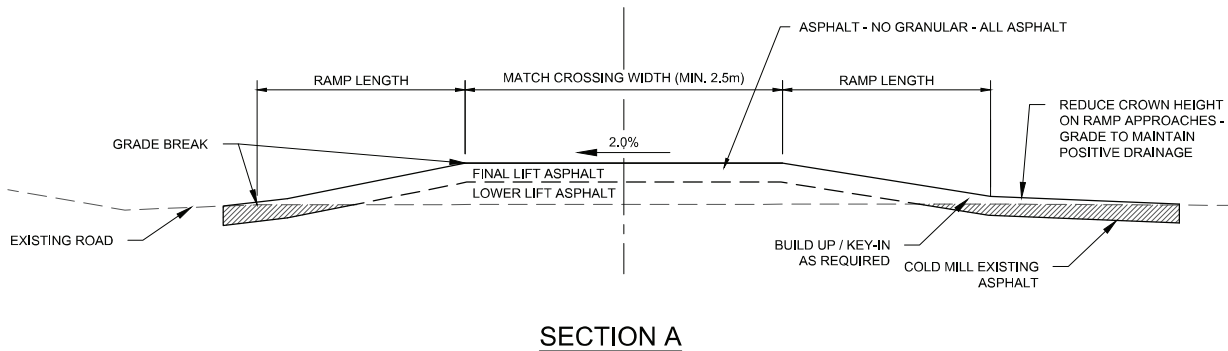
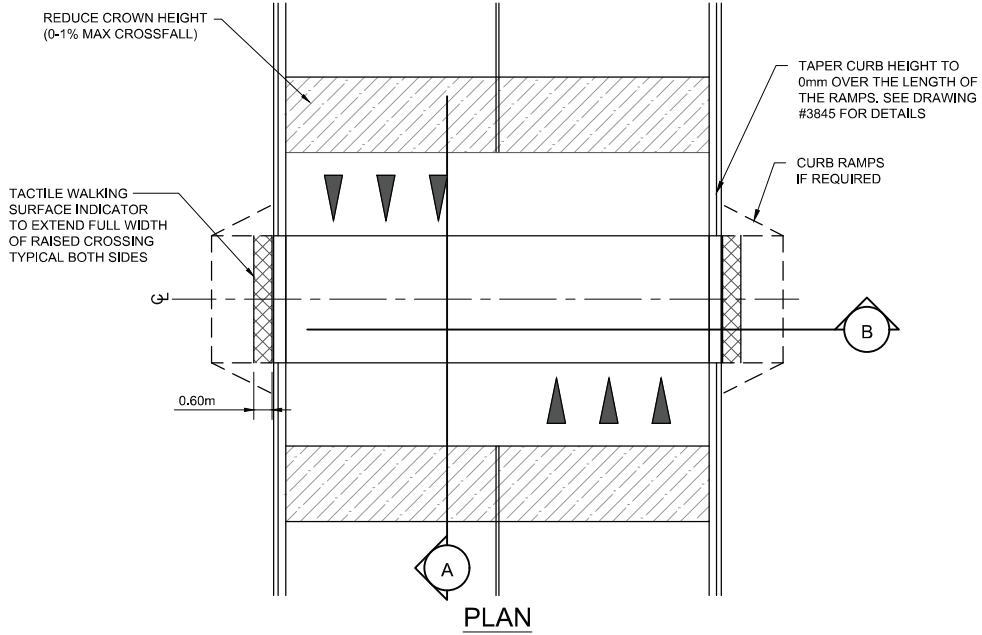

- NOTES:**
- SUPPLEMENTAL SIGNAGE AND PAINT MARKINGS AS PER LATEST EDITION OF THE CITY OF EDMONTON MANUAL FOR PAVEMENT MARKING DESIGN, AND THE MANUAL FOR UNIFORM TRAFFIC CONTROL DEVICES OF CANADA. MARKINGS TO BE CONFIRMED BY ENGINEER
  - MAY REQUIRE CHANGES TO DRAINAGE DESIGN

- NOTES:**
- SEE SECTION 2.3 FOR RAMP LENGTH AND GRADE BREAK REQUIREMENTS

**ALL DIMENSIONS IN MILLIMETRES UNLESS OTHERWISE NOTED**

**RAISED MID BLOCK CROSSING - ASPHALT**



STANDARD DRAWING

DATE APPROVED: **2023**

DRAWN BY: **MT**

APPROVED: *Cherie Fuchs*

DRAWING NUMBER: **3830**

SCALE: **N.T.S.**

CHECKED BY: **MB**

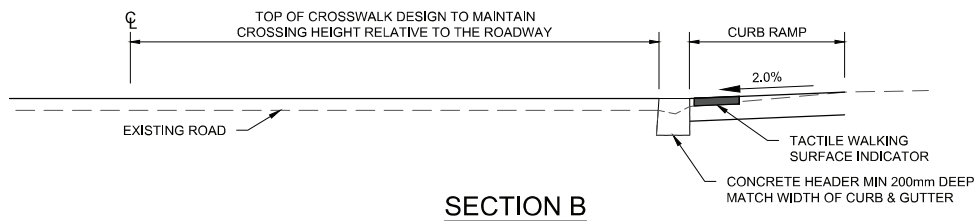
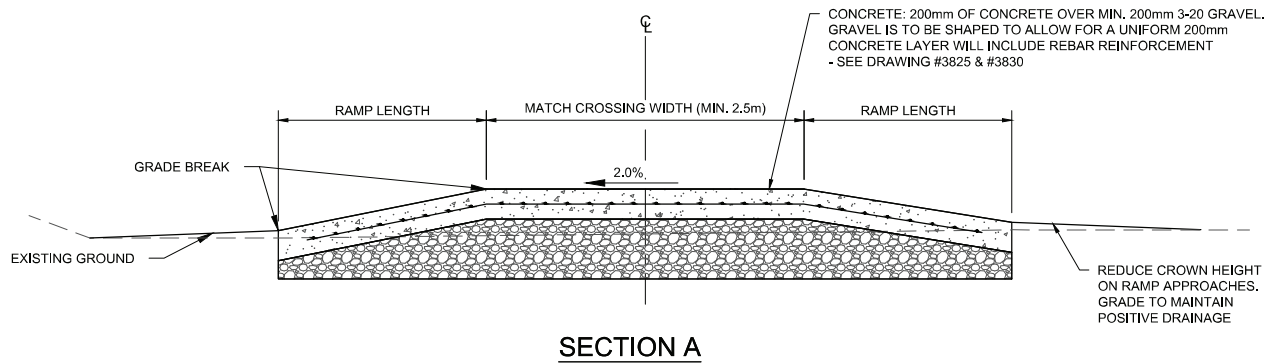
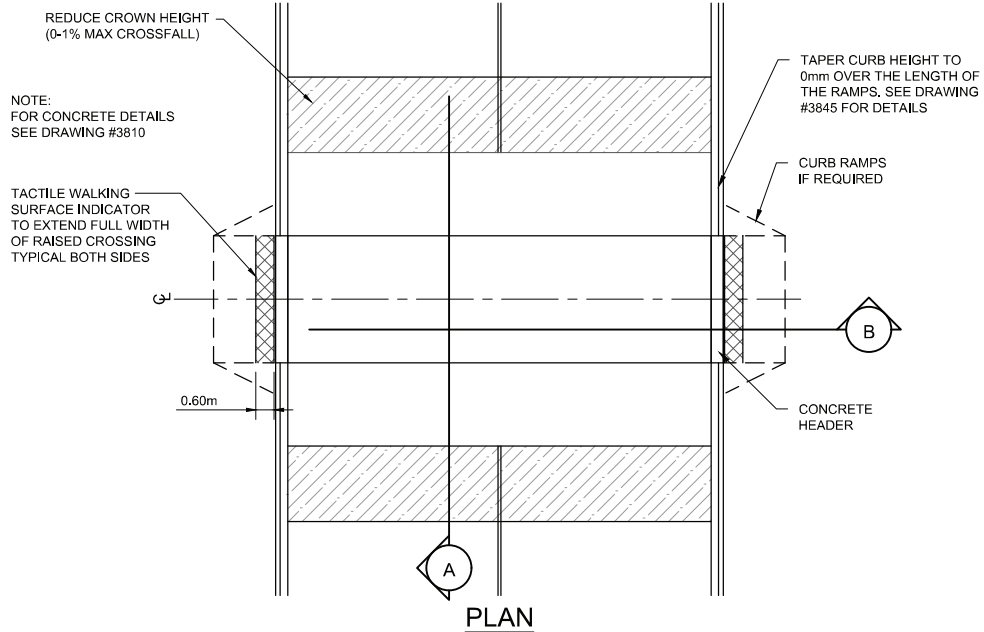

**NOTES:**

- SUPPLEMENTAL SIGNAGE AND PAINT MARKINGS AS PER LATEST EDITION OF THE CITY OF EDMONTON MANUAL FOR PAVEMENT MARKING DESIGN, AND THE MANUAL FOR UNIFORM TRAFFIC CONTROL DEVICES OF CANADA. MARKINGS TO BE CONFIRMED BY ENGINEER
- MAY REQUIRE CHANGES TO DRAINAGE DESIGN

**NOTES:**

- SEE SECTION 2.3 FOR RAMP LENGTH AND GRADE BREAK REQUIREMENTS

**ALL DIMENSIONS IN MILLIMETRES UNLESS OTHERWISE NOTED**

**RAISED MID BLOCK CROSSING - CONCRETE**



STANDARD DRAWING

DATE APPROVED: **2023**

DRAWN BY: **MT**

APPROVED: *Cherie Fuchs*

DRAWING NUMBER: **3835**

SCALE: **N.T.S.**

CHECKED BY: **MB**

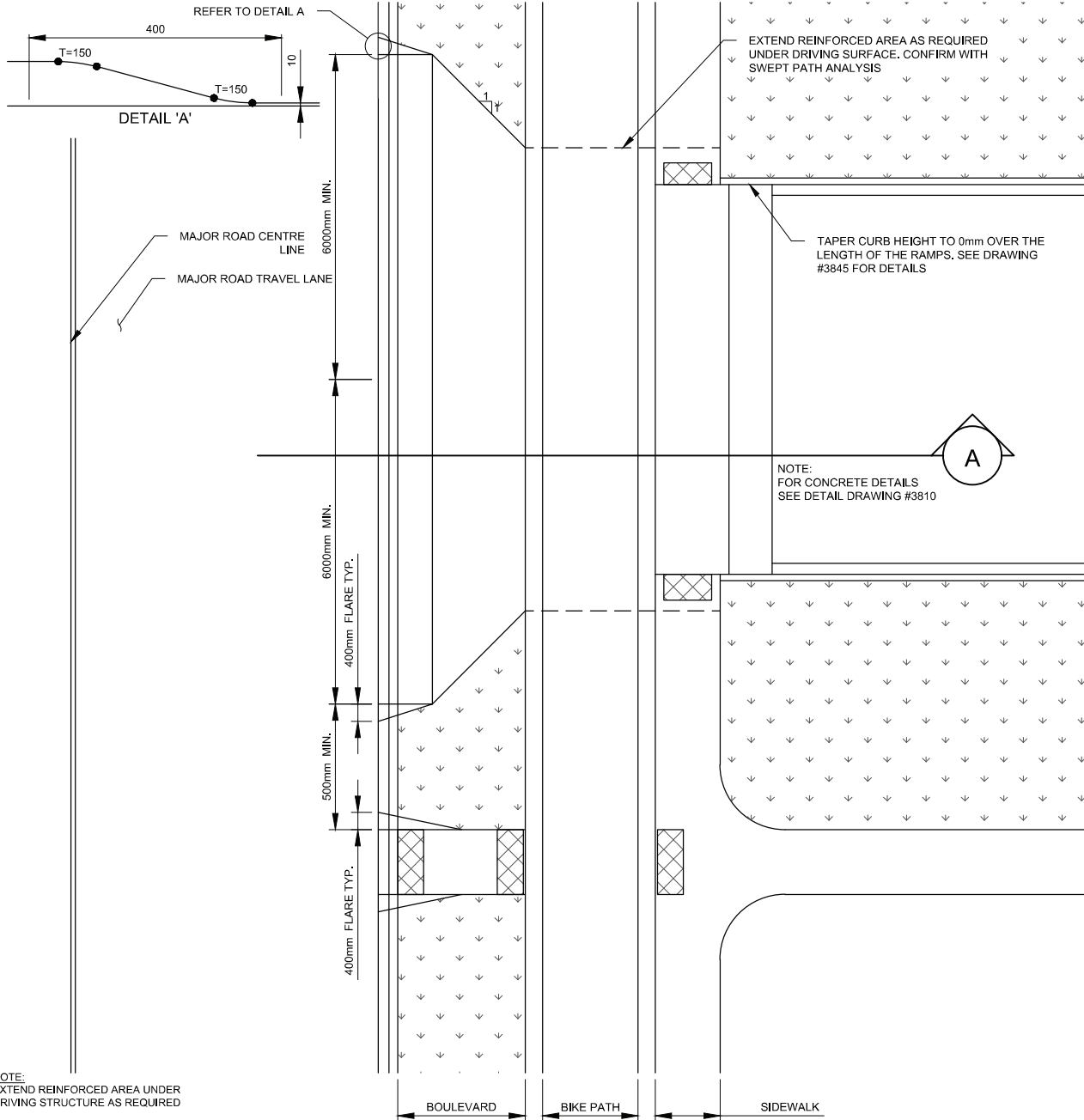

NOTE:  
EXTEND REINFORCED AREA UNDER DRIVING STRUCTURE AS REQUIRED

**PLAN**

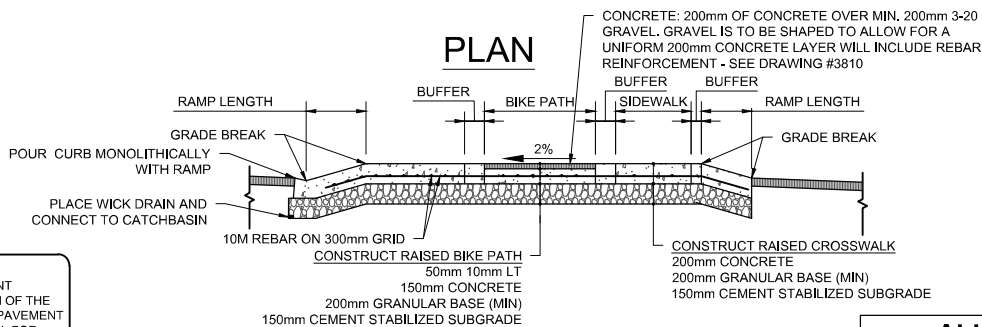

**SECTION A-A**

NOTES:  
1. SEE SECTION 2.3 FOR RAMP LENGTH AND GRADE BREAK REQUIREMENTS

**ALL DIMENSIONS  
IN MILLIMETRES UNLESS  
OTHERWISE NOTED**

- NOTES:**
- SUPPLEMENTAL SIGNAGE AND PAINT MARKINGS AS PER LATEST EDITION OF THE CITY OF EDMONTON MANUAL FOR PAVEMENT MARKING DESIGN, AND THE MANUAL FOR UNIFORM TRAFFIC CONTROL DEVICES OF CANADA. MARKINGS TO BE CONFIRMED BY ENGINEER
  - MAY REQUIRE CHANGES TO DRAINAGE DESIGN



**CONTINUOUS CROSSING**

DATE APPROVED: **2023**

DRAWN BY: **JT**

APPROVED: *Cherie Fuchs*

DRAWING NUMBER: **3840**

SCALE: **N.T.S.**

CHECKED BY: **MB**

8/4/2023 11:29:24 AM

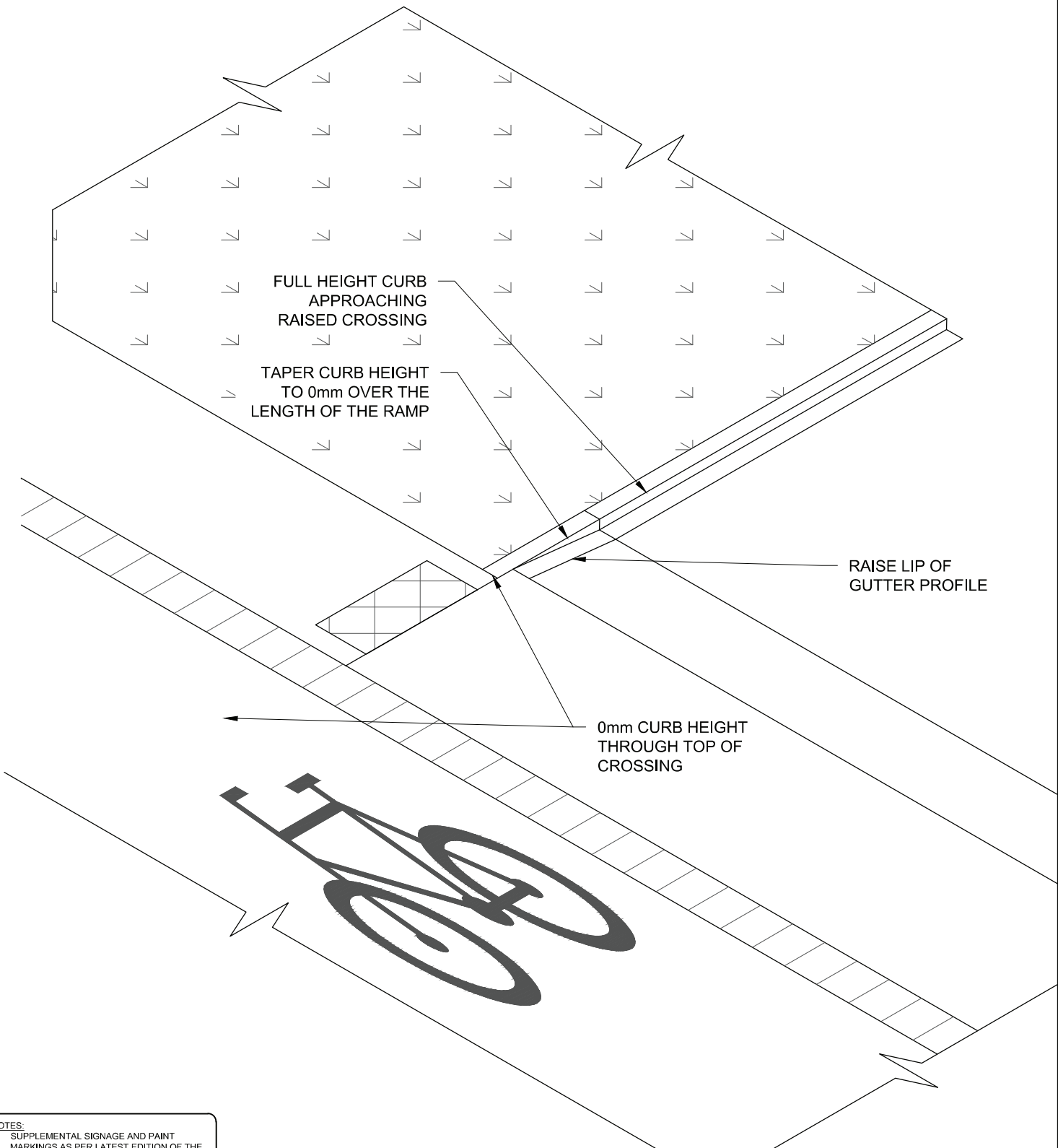

**NOTES:**

- SUPPLEMENTAL SIGNAGE AND PAINT MARKINGS AS PER LATEST EDITION OF THE CITY OF EDMONTON MANUAL FOR PAVEMENT MARKING DESIGN, AND THE MANUAL FOR UNIFORM TRAFFIC CONTROL DEVICES OF CANADA. MARKINGS TO BE CONFIRMED BY ENGINEER
- MAY REQUIRE CHANGES TO DRAINAGE DESIGN

**ALL DIMENSIONS  
IN MILLIMETRES UNLESS  
OTHERWISE NOTED**



**ISOMETRIC DETAIL**

DATE APPROVED: **2023**

SCALE: **N.T.S.**

DRAWN BY: **JT**

CHECKED BY: **MB**

APPROVED:

Designed by: *Cherie Fuchs*

DRAWING NUMBER: **3845**

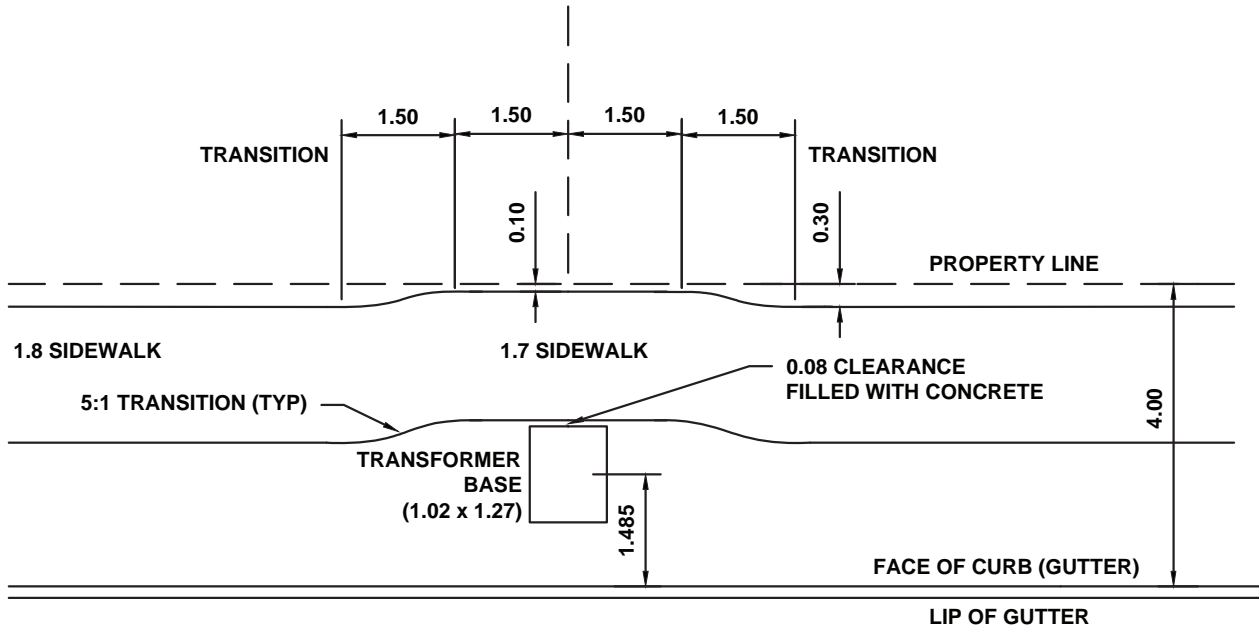

**ROLL FACE CURB AND GUTTER**

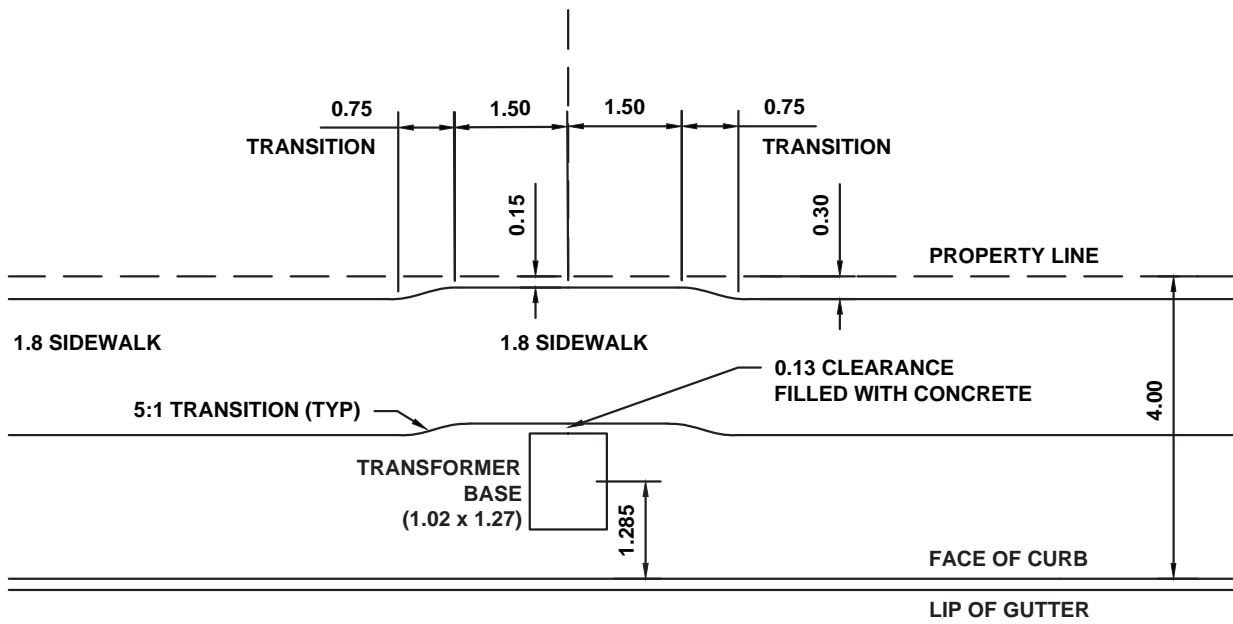

**STRAIGHT FACE CURB AND GUTTER**

**NOTE:**

- 1. ONLY FOR SEPARATED WALK WITH 4.0m BOULEVARD
- 2. GROUNDING RODS ARE 0.5m FROM THE TRANSFORMER

**ALL DIMENSIONS  
 IN METRES UNLESS  
 OTHERWISE NOTED**



STANDARD DRAWING

**BOULEVARD SIDEWALK TRANSITION AT TRANSFORMER**

DATE APPROVED: **2023**  
 SCALE: **N.T.S.**

DRAWN BY: **MW**  
 CHECKED BY: **FW**

APPROVED: *Matthew Ivany*  
DocuSigned by: AB984D7343E14A9...

DRAWING NUMBER: **3900**



## Standard Drawings

### SECTION 4000 – Transit Details



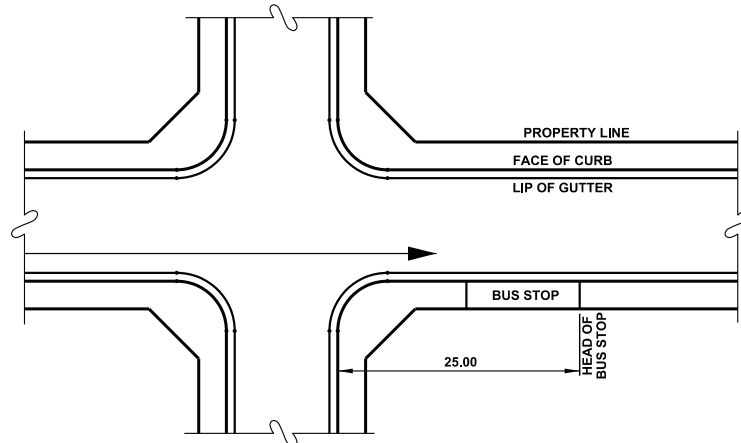

BUS GOES STRAIGHT THROUGH

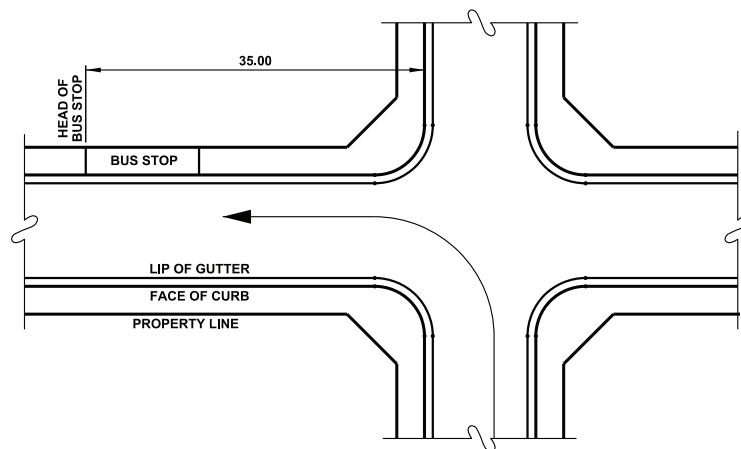

BUS MAKES A LEFT TURN

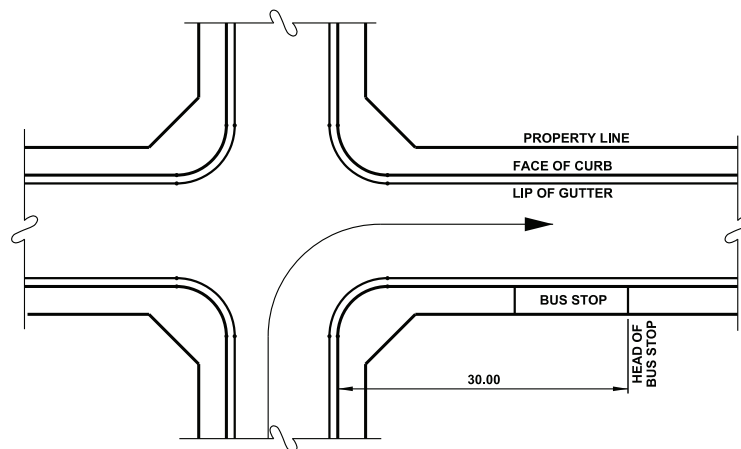

BUS MAKES A RIGHT TURN

NOTES:

- 1. STRAIGHT FACE CURB AND GUTTER REQUIRED AT BUS STOP

**ALL DIMENSIONS  
IN METRES UNLESS  
OTHERWISE NOTED**

**LOCATION OF BUS STOP  
(UNCHANNELIZED INTERSECTION)**



STANDARD DRAWING

DATE APPROVED: 2018

DRAWN BY: KSYC

APPROVED: *M.R.*

DRAWING NUMBER: 4000

SCALE: N.T.S.

CHECKED BY: JN

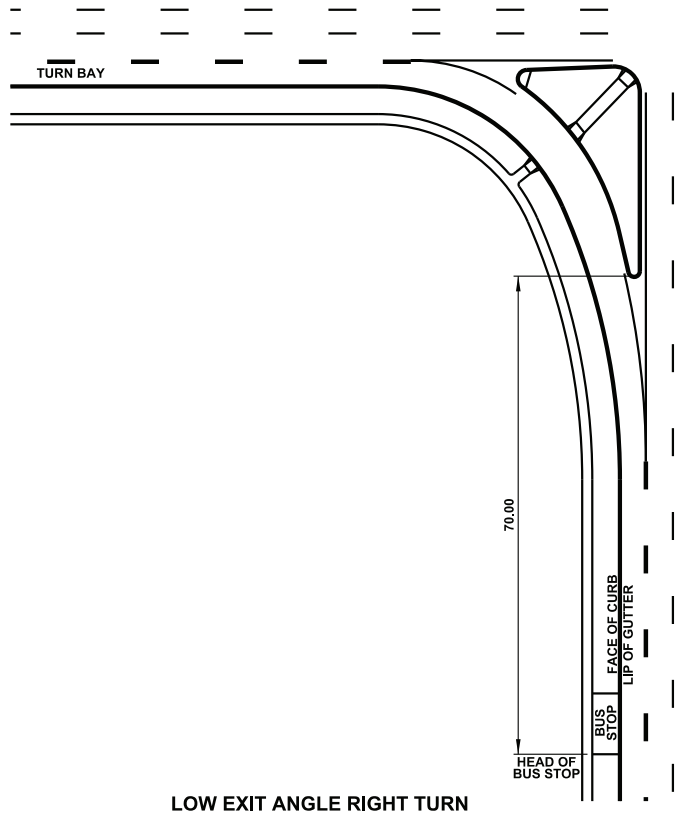
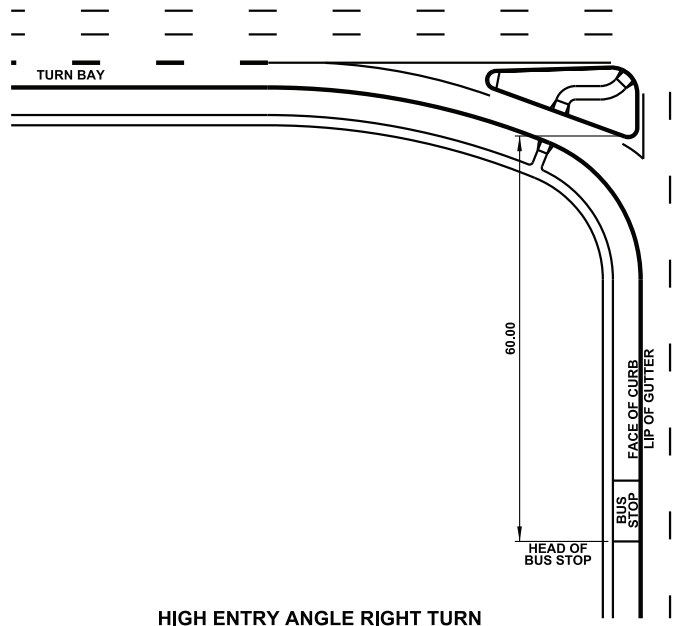

NOTE:

- 1. LOCATION OF BUS STOP AT ROUNDABOUT SEE STANDARD DRAWING #3720.

**ALL DIMENSIONS  
IN METRES UNLESS  
OTHERWISE NOTED**

**LOCATION OF BUS STOP  
(CHANNELIZED INTERSECTION)**



STANDARD DRAWING

DATE APPROVED: **2018**

DRAWN BY: **KSYC**

APPROVED: *M.A.R.*

DRAWING NUMBER: **4010**

SCALE: **N.T.S.**

CHECKED BY: **JN**

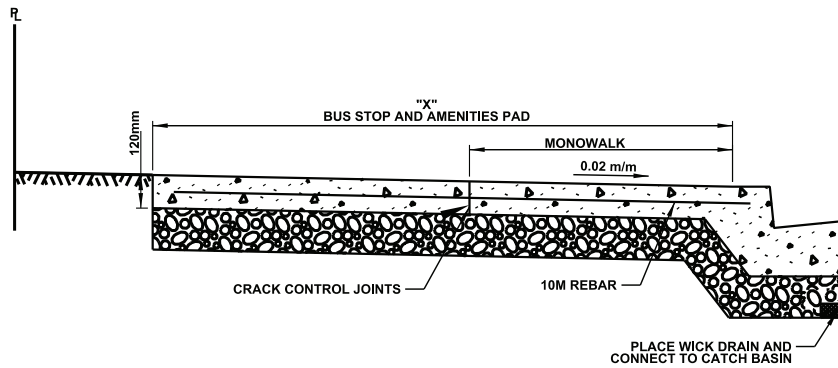
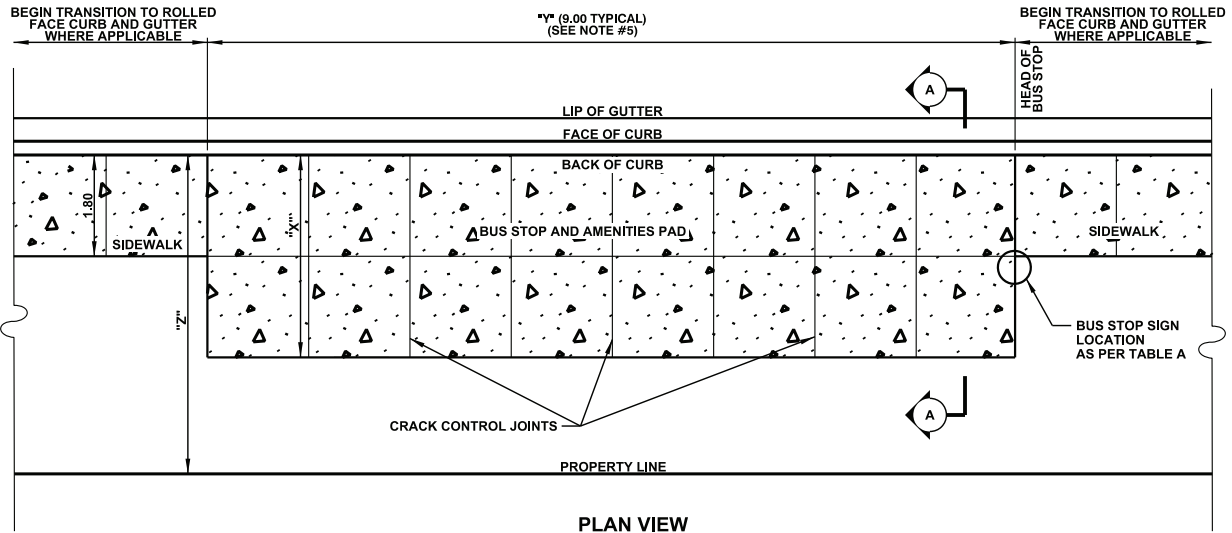

SECTION A-A

TABLE A  
BUS STOP AND AMENITIES PAD SIZE

CONDITION	"Z" DISTANCE TO PROPERTY LINE	"X" REQUIRED PAD WIDTH	(SEE NOTE #5) "Y" REQUIRED PAD LENGTH	BUS STOP SIGN LOCATION BEHIND SIDEWALK
OVER CONSTRAINED	"Z" < 2.80	2.10	9.00	HEAD OF PAD
CONSTRAINED	2.80 ≤ "Z" < 3.90	"Z" - 0.30 [3.00 (MAX.)]	12.00	3.00 BACK FROM HEAD OF PAD
NOT CONSTRAINED	"Z" > 3.90	"Z" - 0.30 [4.10 (MAX.)]	9.00	HEAD OF PAD

NOTES:

1. PROVIDE BUS STOP AND AMENITIES PAD WITH WIDTH "X" AND LENGTH "Y" IN ACCORDANCE WITH THE DRAWING NOTES AND TABLE A (SEE ABOVE). PROVIDE APPROPRIATE CRACK CONTROL JOINTS THROUGHOUT.
2. MAINTAIN 0.30m (MIN.) CLEARANCE BETWEEN PROPERTY LINE AND AMENITIES PAD.
3. STRAIGHT FACE CURB AND GUTTER REQUIRED AT BUS STOP.
4. BUS STOP AND AMENITIES PAD TO BE POURED MONOLITHICALLY WITH CURB AND GUTTER.
5. FOR REQUIRED LENGTH:  
- ADD 3.00 FOR MULTIPLE, FREQUENT ROUTES  
- ADD 5.00 FOR ARTICULATED BUS STOP

**ALL DIMENSIONS  
IN METRES UNLESS  
OTHERWISE NOTED**

**BUS STOP AND AMENITIES PAD  
MONOWALK**



STANDARD DRAWING

DATE APPROVED: **2018**

DRAWN BY: **KSYC**

APPROVED: *M.R.*

DRAWING NUMBER: **4100**

SCALE: **N.T.S.**

CHECKED BY: **JN**

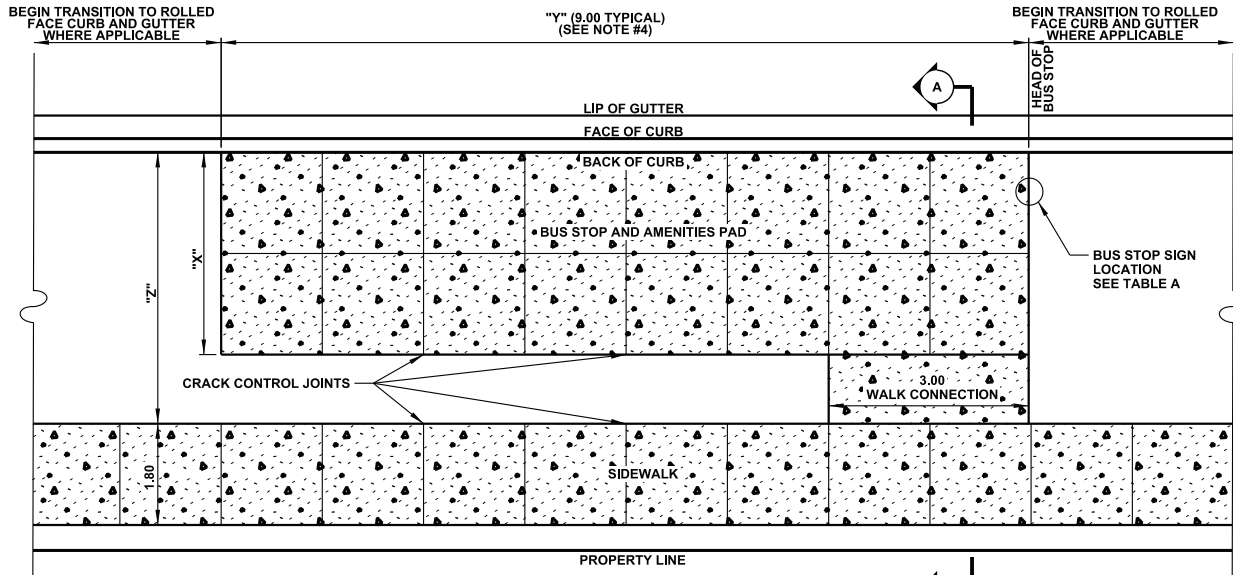

PLAN VIEW

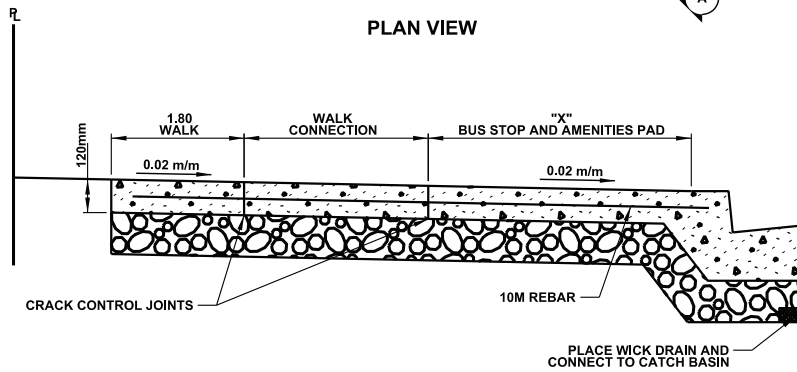

SECTION A-A

TABLE A  
BUS STOP AND AMENITIES PAD SIZE

CONDITION	"Z" DISTANCE TO SIDEWALK	"X" REQUIRED PAD WIDTH	"Y" (SEE NOTE #4) REQUIRED PAD LENGTH	BUS STOP SIGN LOCATION
OVER CONSTRAINED	"Z" < 2.25	NOT PERMISSIBLE	NOT PERMISSIBLE	NOT PERMISSIBLE
CONSTRAINED	2.25 <= "Z" < 3.60	"X" = "Z"	12.00	3.00 BACK FROM HEAD OF PAD
NOT CONSTRAINED	3.60 <= "Z"	"X" = "Z" 4.10 (MAX.)	9.00	HEAD OF PAD

NOTES:

1. PROVIDE BUS STOP AND AMENITIES PAD WITH WIDTH "X" AND LENGTH "Y" IN ACCORDANCE WITH THE DRAWING NOTES AND TABLE A (SEE ABOVE). PROVIDE APPROPRIATE CRACK CONTROL JOINTS THROUGHOUT.
2. IF REQUIRED PAD WIDTH "X" IS LESS THAN 1.00m FROM SIDEWALK, POUR THE CONCRETE PAD TO SIDEWALK. OTHERWISE, PROVIDE 3.00m WIDE WALK CONNECTION AT HEAD OF THE PAD.
3. STRAIGHT FACE CURB AND GUTTER REQUIRED AT BUS STOP.
4. FOR REQUIRED LENGTH:
  - ADD 3.00 FOR MULTIPLE, FREQUENT ROUTES
  - ADD 5.00 FOR ARTICULATED BUS STOP

**ALL DIMENSIONS  
IN METRES UNLESS  
OTHERWISE NOTED**

**BUS STOP AND AMENITIES PAD  
BOULEVARD WALK**



STANDARD DRAWING

DATE APPROVED: **2018**

DRAWN BY: **KSYC**

APPROVED: *M.R.*

DRAWING NUMBER: **4110**

SCALE: **N.T.S.**

CHECKED BY: **JN**

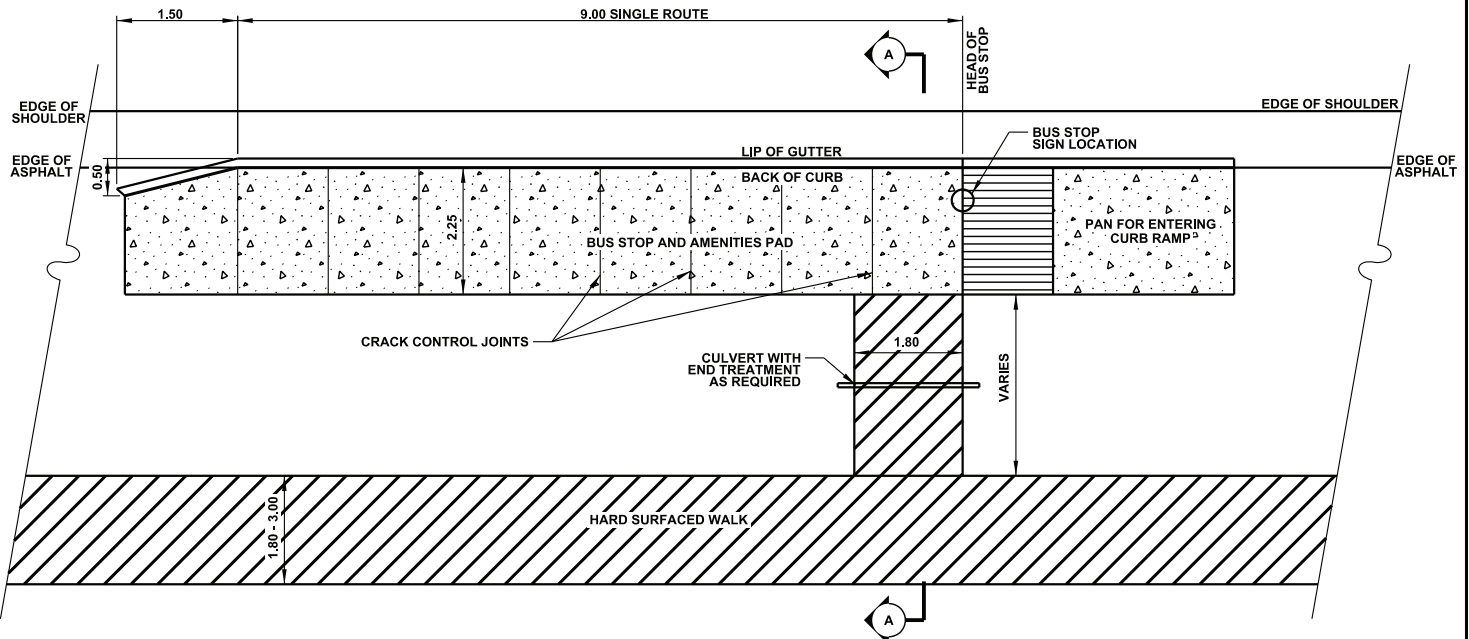

PLAN VIEW

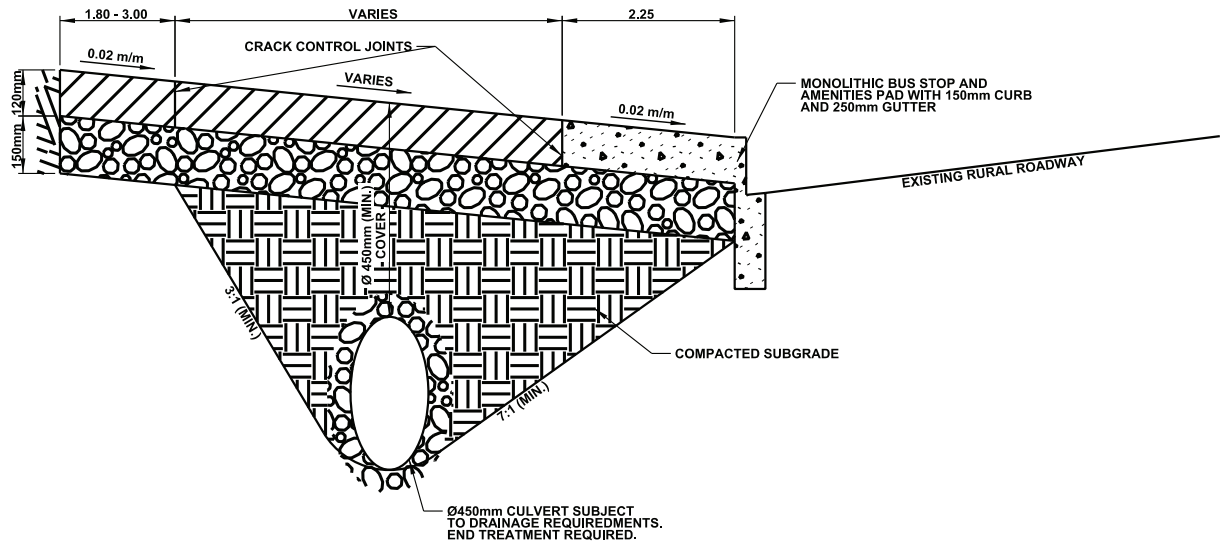

SECTION A-A

NOTES:

1. STRAIGHT FACE CURB AND GUTTER REQUIRED AT BUS STOP.
2. CULVERT DIAMETER SEE DRAWING #3020.
3. CURB RAMP AT HEAD OF BUS STOP IS REQUIRED IF THERE ARE NO EXISTING BOULEVARD CONNECTION. CURB RAMP TO BE FLUSHED WITH EDGE OF ASPHALT.
4. RAILING REQUIREMENT AT BACK OF BUS STOP TO BE DETERMINED AT DETAILED DESIGN TO SATISFACTION OF CITY OF EDMONTON.

**ALL DIMENSIONS  
IN METRES UNLESS  
OTHERWISE NOTED**

**BUS STOP AND AMENITIES PAD  
RURAL ROADWAY**



STANDARD DRAWING

DATE APPROVED: **2018**

DRAWN BY: **KSYC**

APPROVED: *M.A.R.*

DRAWING NUMBER: **4200**

SCALE: **N.T.S.**

CHECKED BY: **JN**

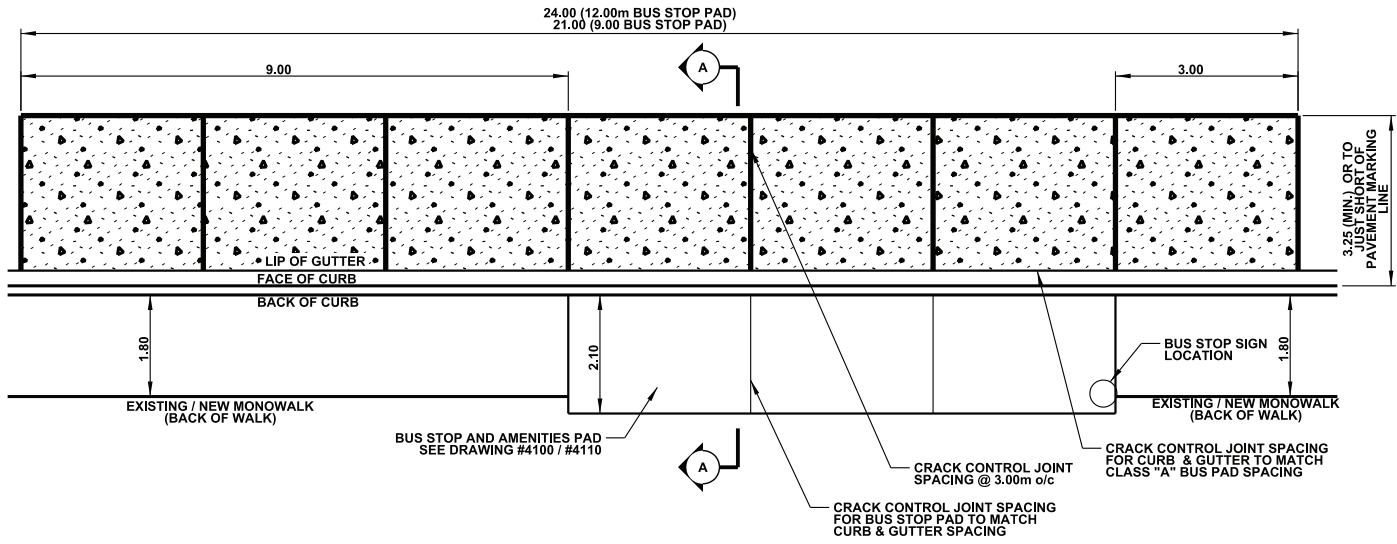

PLAN VIEW

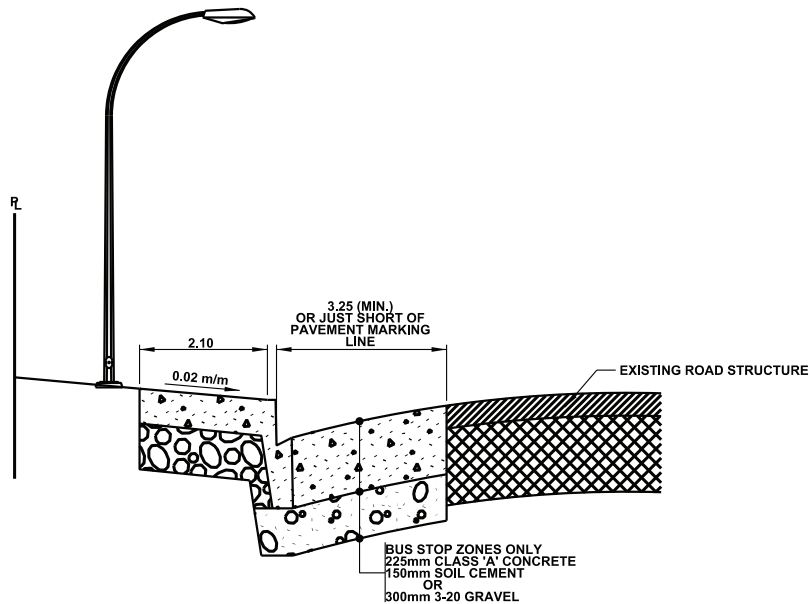

SECTION A-A

NOTES:

1. STRAIGHT FACE CURB AND GUTTER REQUIRED AT BUS STOP.

ALL DIMENSIONS  
IN METRES UNLESS  
OTHERWISE NOTED



STANDARD DRAWING

2023-08-31

CLASS 'A' CONCRETE BUS STOP PAD  
(RETROFIT)

DATE APPROVED: 2018

DRAWN BY: KSYC

APPROVED: *M.R.*

DRAWING NUMBER: 4250

SCALE: N.T.S.

CHECKED BY: JN

v05

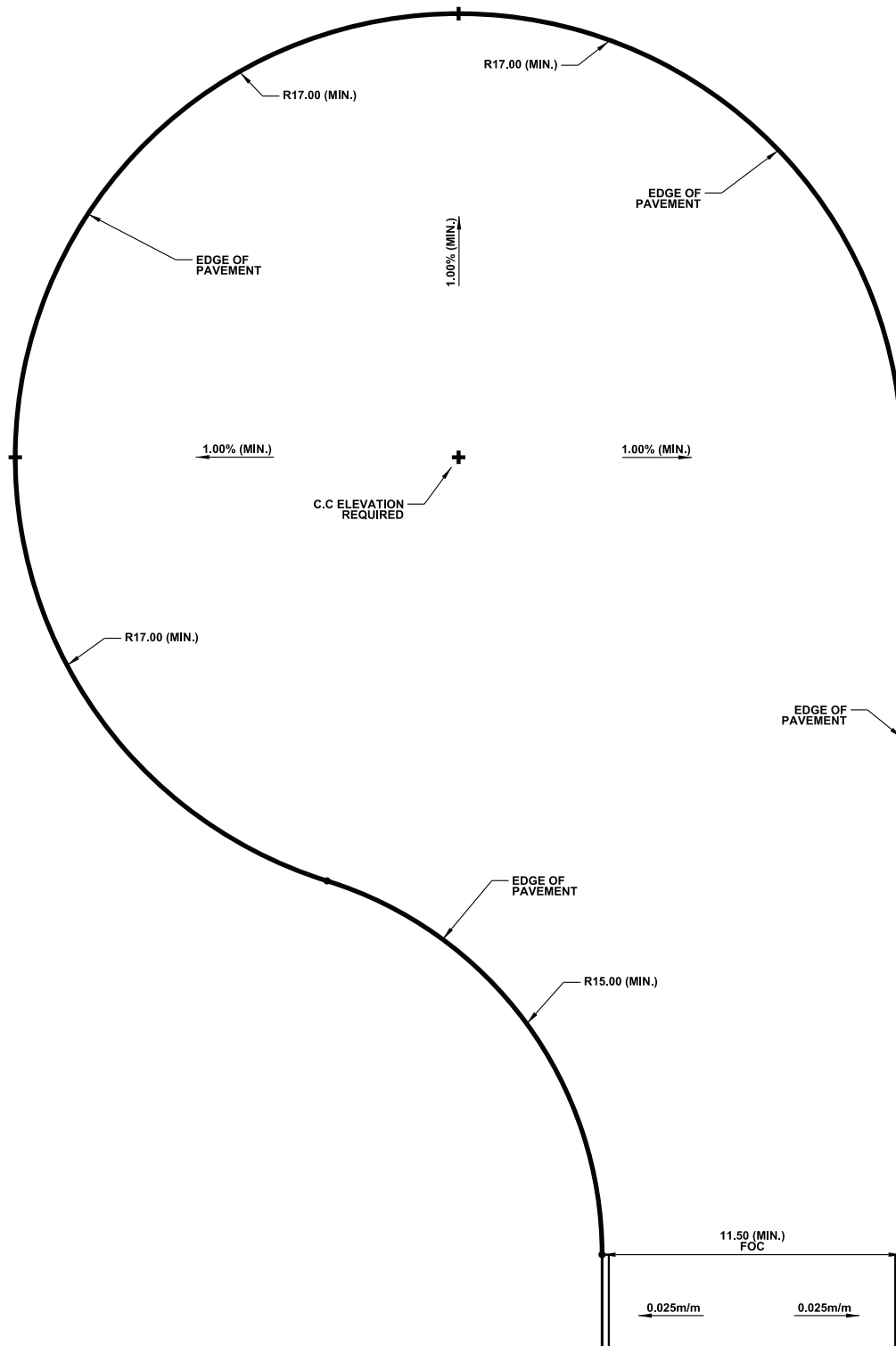

NOTES:

1. PROVIDE ELEVATION FOR ALL CROSS SYMBOL (+) SHOWN.
2. FOR TEMPORARY TURNAROUND WITH NO CURB AND GUTTER, PLACE MINI BARRIERS OR INSTALL BARRIER POSTS @ 1.50m ON CENTRE ALONG OUTSIDE EDGE OF PAVEMENT ON TURNAROUND.

**ALL DIMENSIONS  
IN METRES UNLESS  
OTHERWISE NOTED**



STANDARD DRAWING

**TRANSIT TURNAROUND  
(OFFSET)**

DATE APPROVED: **2018**  
SCALE: **N.T.S.**

DRAWN BY: **KSYC**  
CHECKED BY: **JN**

APPROVED: *M.A.R.*

DRAWING NUMBER: **4300**

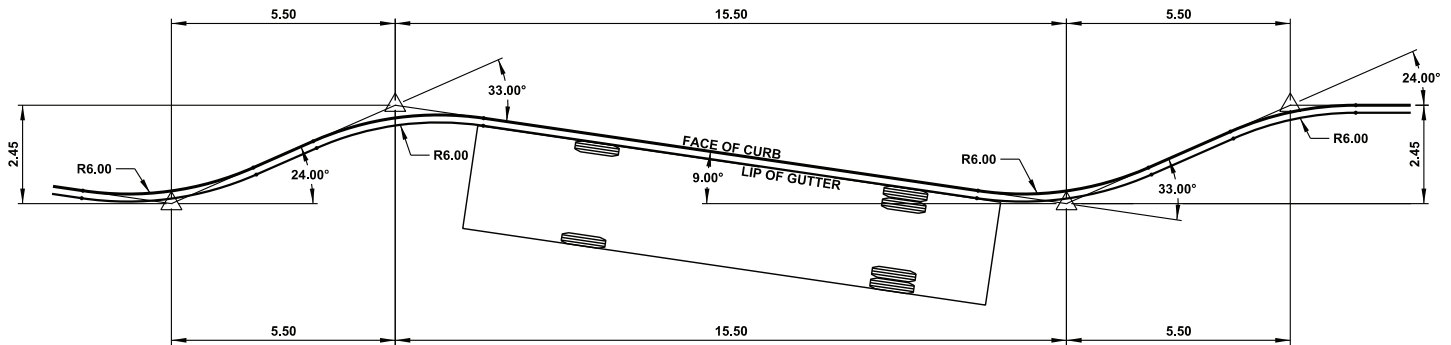

**BUS SAWTOOTH TRANSIT BAY  
STANDARD (12.00)**

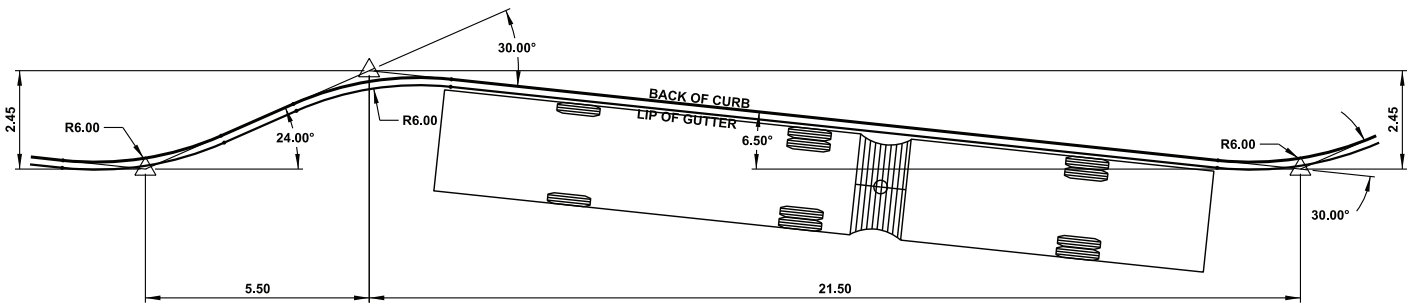

**SAWTOOTH TRANSIT BAY  
ARTICULATED (18.00)**

**NOTE:**

1. CROSSWALKS SHALL BE ACCOMMODATED BY PROVIDING 4.00m LENGTH OF STRAIGHT CURB BETWEEN CONSECUTIVE BAYS.
2. ALL RADII ARE TO LIP OF GUTTER.

**ALL DIMENSIONS  
IN METRES UNLESS  
OTHERWISE NOTED**



STANDARD DRAWING

**SAWTOOTH TRANSIT BAY  
TRANSIT TERMINAL SITE**

DATE APPROVED: **2018**

SCALE: **N.T.S.**

DRAWN BY: **KSYC**

CHECKED BY: **JN**

APPROVED: *M.A.R.*

DRAWING NUMBER: **4400**





## Standard Drawings

### SECTION 5000 – Construction Details

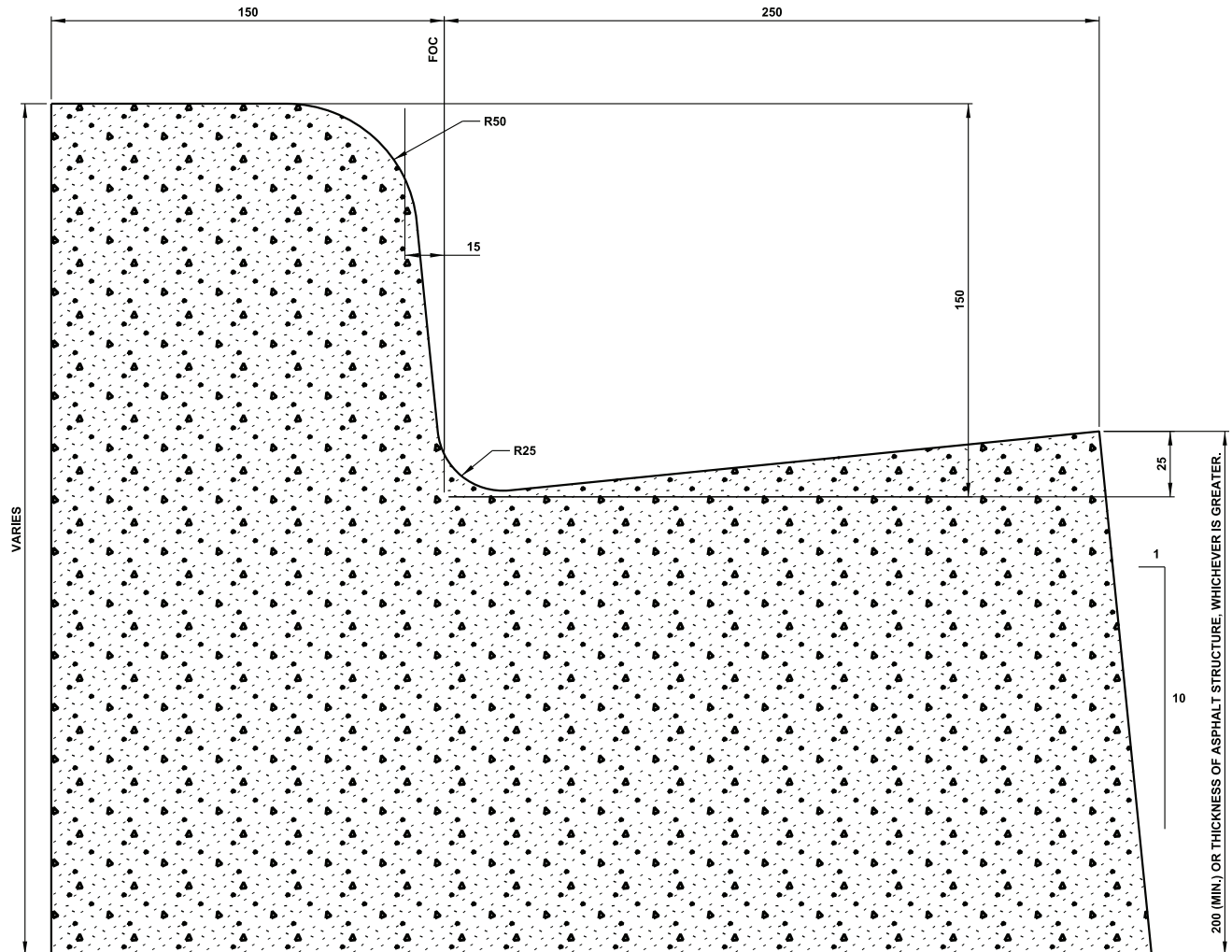

**ALL DIMENSIONS  
IN MILLIMETRES UNLESS  
OTHERWISE NOTED**

**150mm CURB WITH 250mm GUTTER**



DATE APPROVED: **2018**

SCALE: **N.T.S.**

DRAWN BY: **KSYC**

CHECKED BY: **JN**

APPROVED: *M.A.R.*

DRAWING NUMBER: **5000**

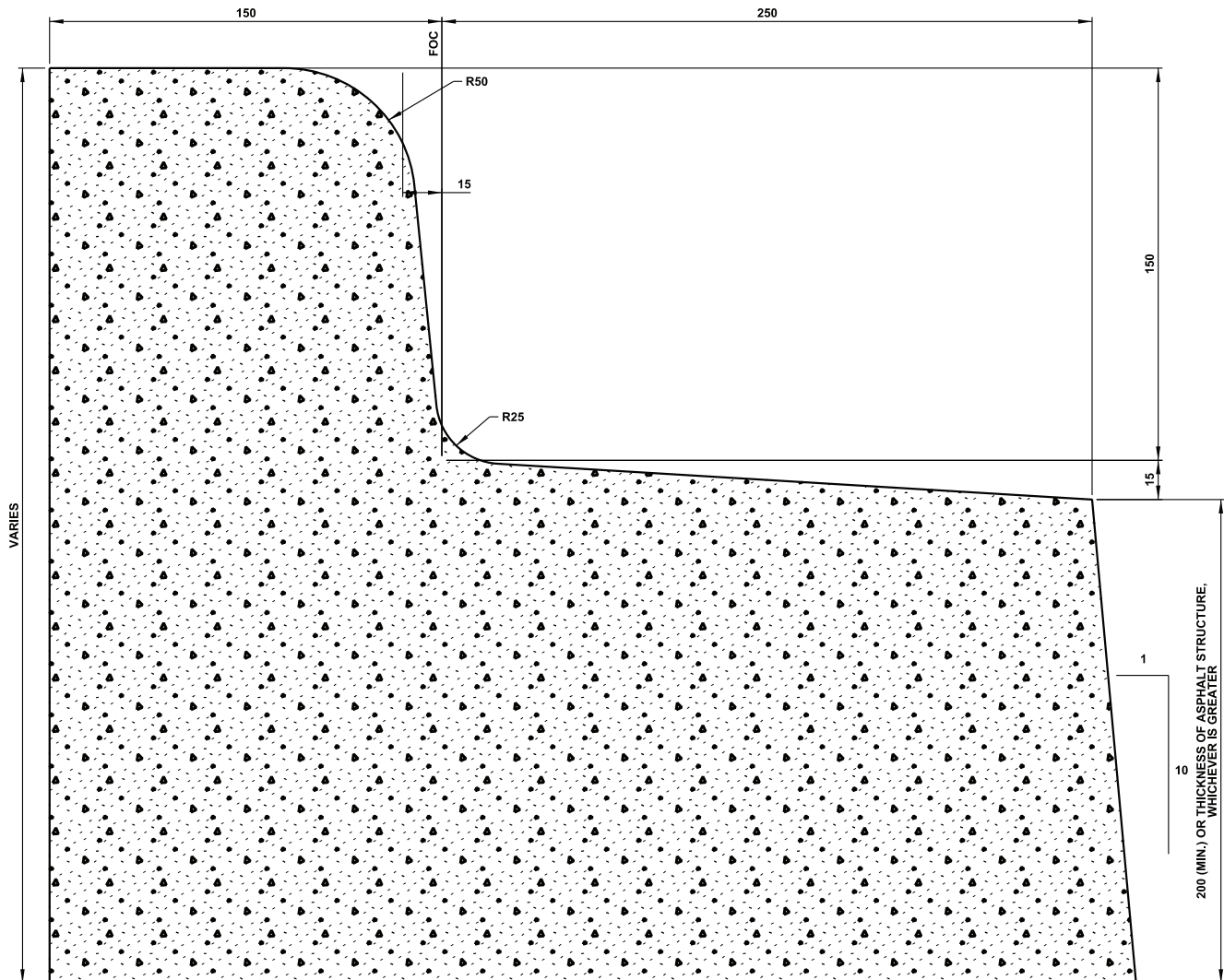

NOTES:

- 1. LOCATION OF REVERSE CURB AND GUTTER ARE SUBJECT TO CITY OF EDMONTON APPROVAL.

**ALL DIMENSIONS  
IN MILLIMETRES UNLESS  
OTHERWISE NOTED**



**150mm CURB WITH REVERSE 250mm GUTTER**

DATE APPROVED: **2018**  
SCALE: **N.T.S.**

DRAWN BY: **KSYC**  
CHECKED BY: **JN**

APPROVED: *M.A.R.*

DRAWING NUMBER: **5001**

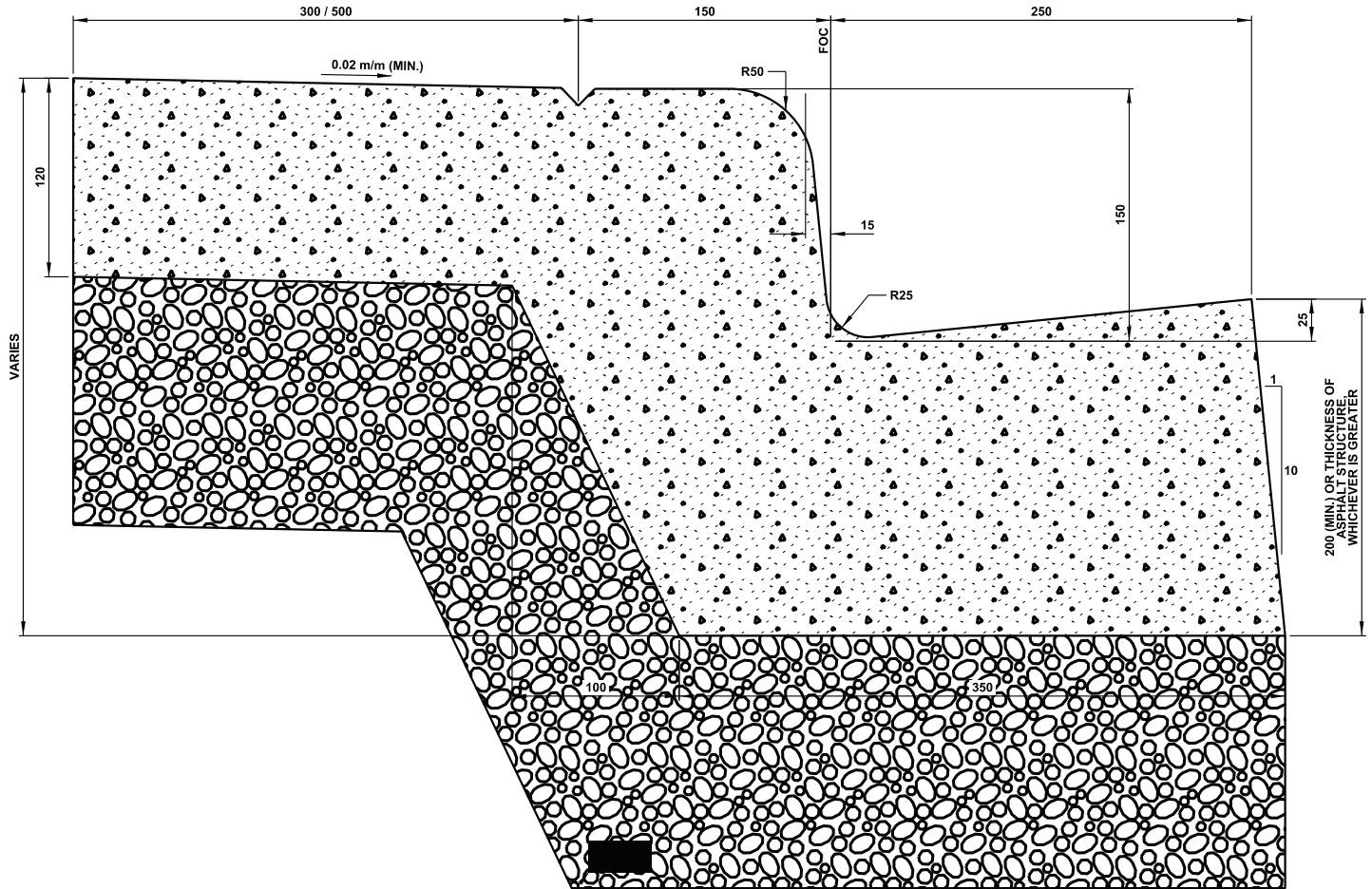

PLACE WICK DRAIN AND CONNECT TO CATCH BASIN WHERE APPLICABLE

**NOTES:**

1. CONCRETE HEADER TO BE POURED MONOLITHICALLY WITH CURB AND GUTTER.
2. LANDSCAPED MEDIAN HEADER WIDTH TO BE 500mm. ALL OTHER MEDIAN HEADER WIDTH TO BE 300mm.

**ALL DIMENSIONS  
IN MILLIMETRES UNLESS  
OTHERWISE NOTED**



**Edmonton**

STANDARD DRAWING

**150mm CURB AND 250mm GUTTER WITH MONO CONCRETE HEADER**

DATE APPROVED: **2018**

SCALE: **N.T.S.**

DRAWN BY: **KSYC**

CHECKED BY: **JN**

APPROVED: *M.A.R.*

DRAWING NUMBER: **5010**

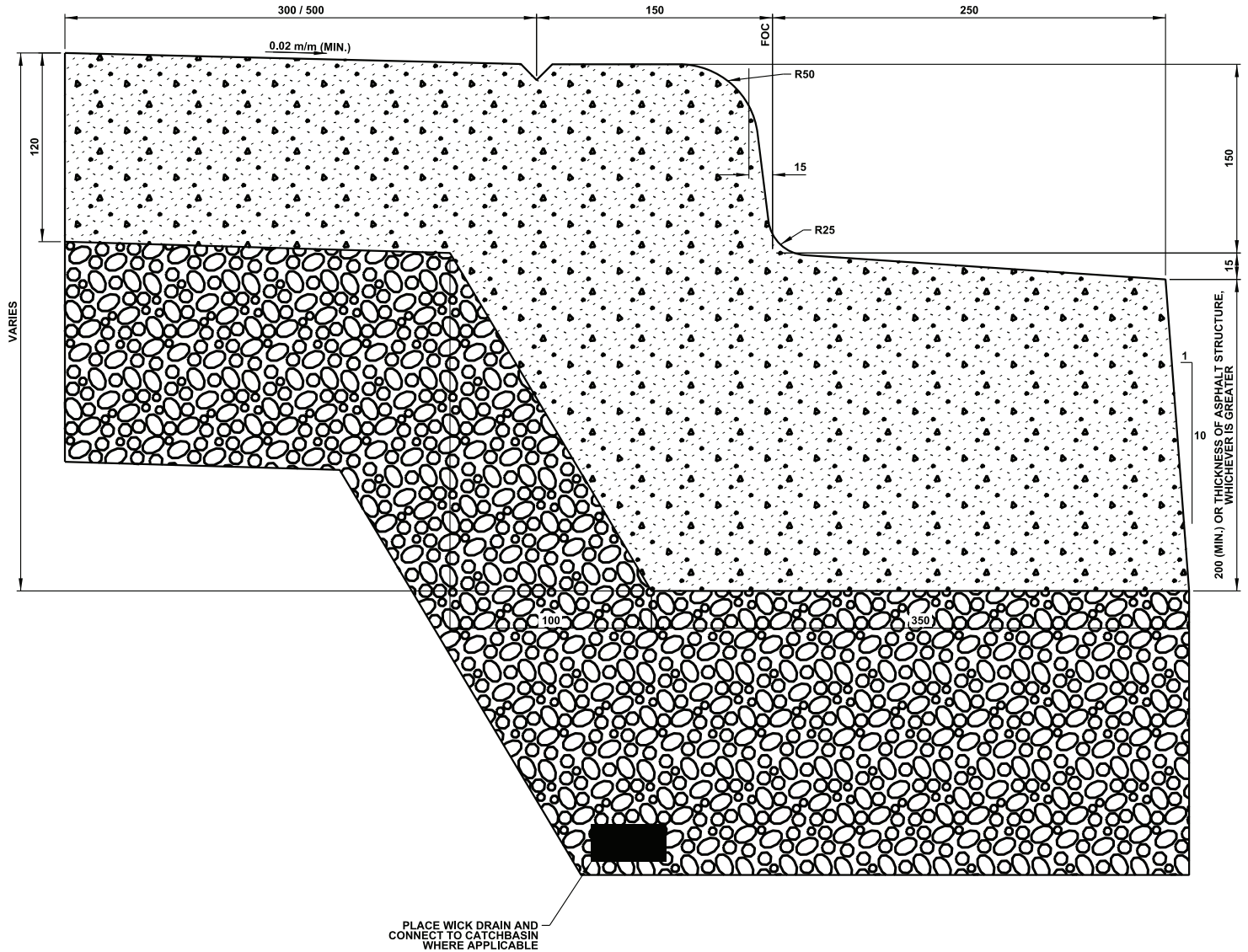

**NOTE:**

1. CONCRETE HEADER TO BE POURED MONOLITHICALLY WITH CURB AND GUTTER.
2. LANDSCAPED MEDIAN HEADER WIDTH TO BE 500mm. ALL OTHER MEDIAN HEADER WIDTH TO BE 300mm.

**ALL DIMENSIONS  
IN MILLIMETRES UNLESS  
OTHERWISE NOTED**



**150mm CURB AND 250mm REVERSE GUTTER WITH MONO CONCRETE HEADER**

DATE APPROVED: **2018**

SCALE: **N.T.S.**

DRAWN BY: **KSYC**

CHECKED BY: **JN**

APPROVED: *M.A.R.*

DRAWING NUMBER: **5011**

ALL DIMENSIONS  
IN MILLIMETRES UNLESS  
OTHERWISE NOTED

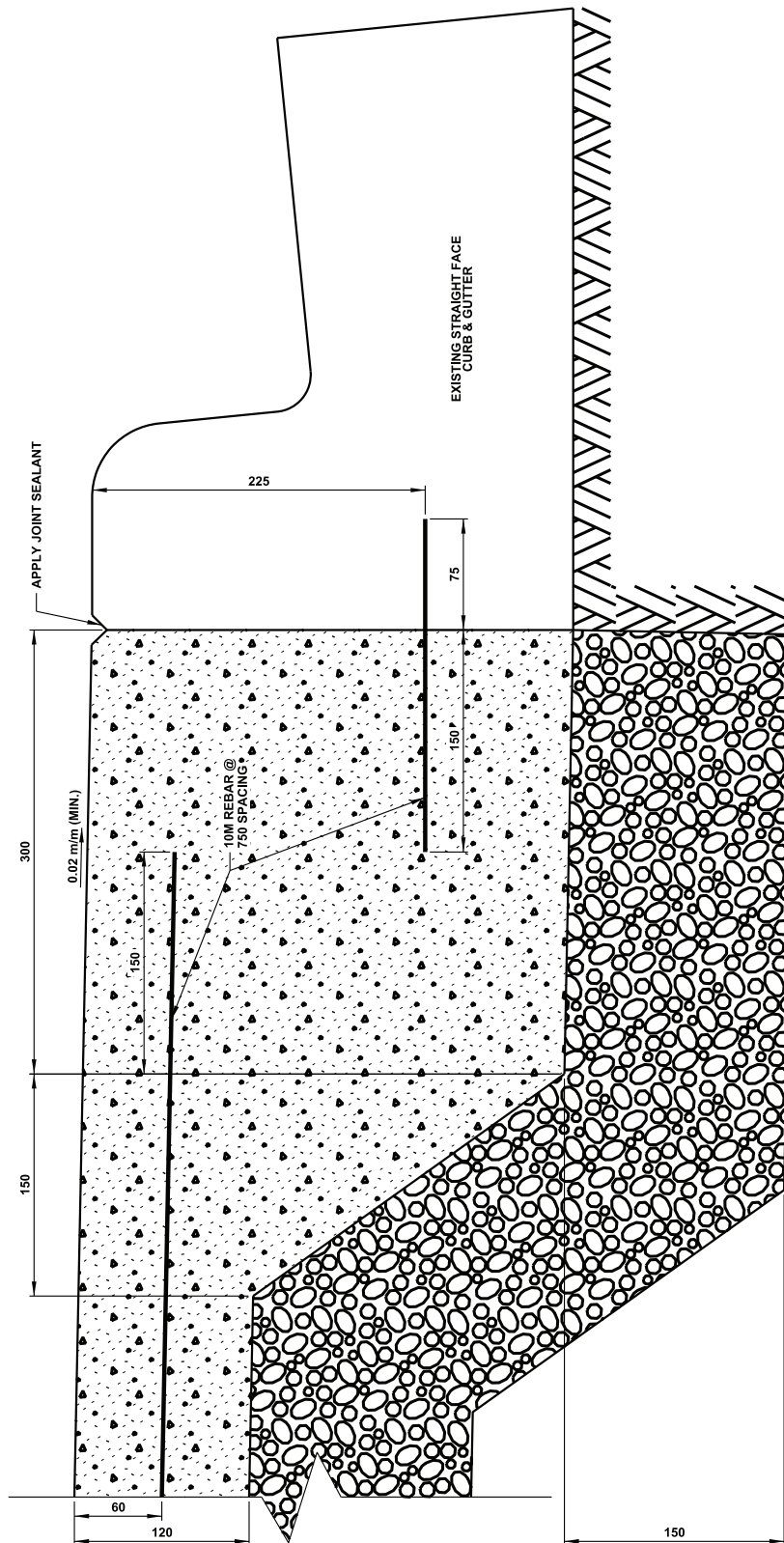

NOTES:

1. ALL NEW CONSTRUCTION REQUIRES CURBLINE WALK AND BUS STOP PADS TO BE POURED MONOLITHICALLY WITH CURB AND GUTTER.
2. THIS METHOD OF RETROFIT CONSTRUCTION CANNOT BE USED UNLESS AUTHORIZED BY THE CITY OF EDMONTON.
3. EPOXY REBAR INTO EXISTING CURB AND GUTTER.



STANDARD DRAWING

2023-08-31

STRAIGHT FACE CONCRETE CURBLINE WALK / BUS STOP (RETROFIT)

DATE APPROVED: 2018

DRAWN BY: KSYC

APPROVED: *M.A.R.*

DRAWING NUMBER: 5020

SCALE: N.T.S.

CHECKED BY: JN

v05

Page 598

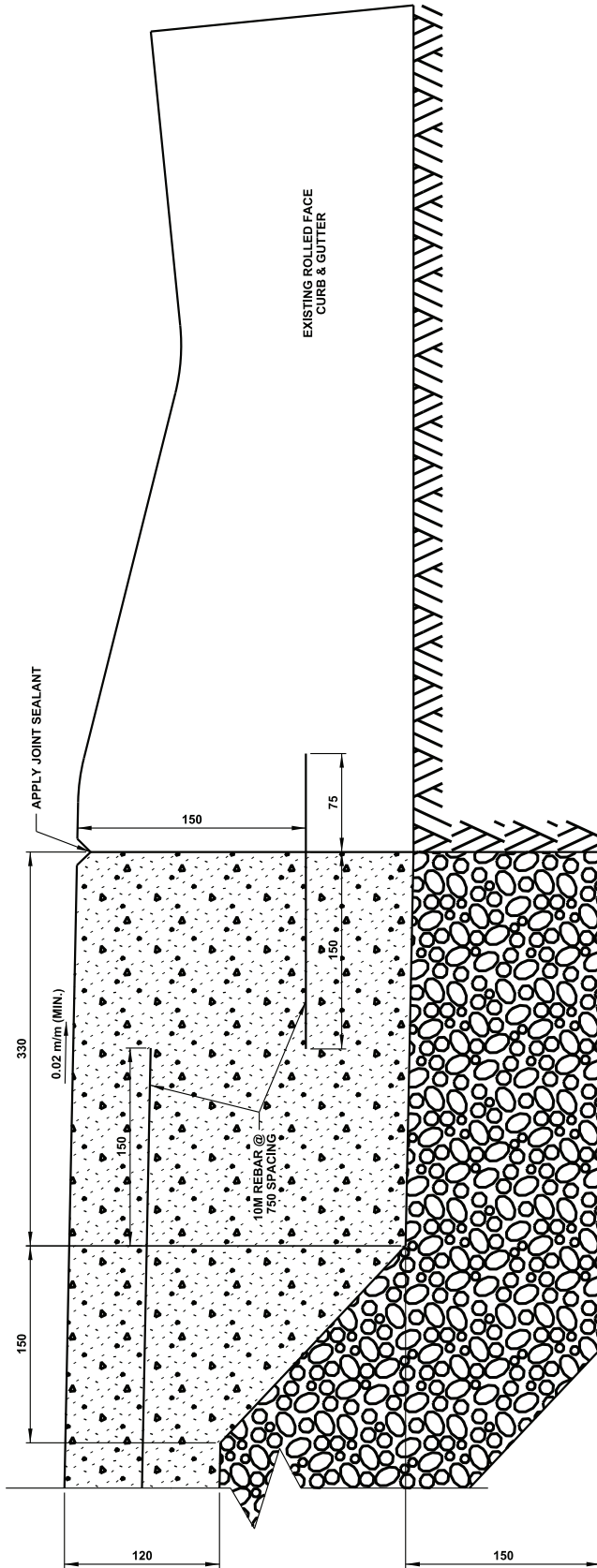

**ALL DIMENSIONS  
IN MILLIMETRES UNLESS  
OTHERWISE NOTED**

- NOTES:**
1. ALL NEW CONSTRUCTION REQUIRES CURBLINE WALK AND BUS STOP PADS TO BE POURED MONOLITHICALLY WITH CURB AND GUTTER.
  2. THIS METHOD OF RETROFIT CONSTRUCTION CANNOT BE USED UNLESS AUTHORIZED BY THE CITY OF EDMONTON.
  3. EPOXY REBAR INTO EXISTING CURB AND GUTTER.



STANDARD DRAWING

2023-08-31

**ROLLED FACE CURBLINE WALK (RETROFIT)**

DATE APPROVED: **2018**

SCALE: **N.T.S.**

DRAWN BY: **KSYC**

CHECKED BY: **JN**

APPROVED: *M.R.*

DRAWING NUMBER:

**5021**

v05

Page 599

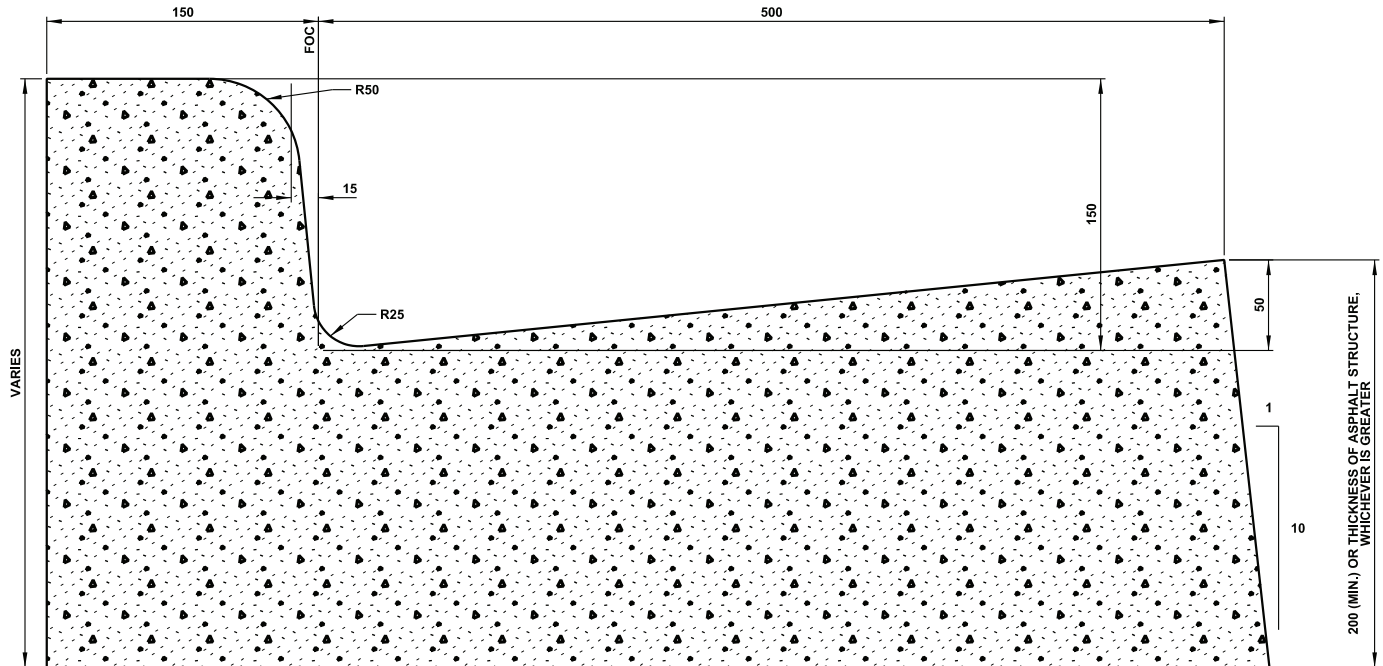

**ALL DIMENSIONS  
IN MILLIMETRES UNLESS  
OTHERWISE NOTED**



STANDARD DRAWING

2023-08-31

**150mm CURB AND 500mm GUTTER (RETROFIT)**

DATE APPROVED: **2018**

DRAWN BY: **KSYC**

APPROVED: *M.A.R.*

DRAWING NUMBER: **5022**

SCALE: **N.T.S.**

CHECKED BY: **JN**

v05

Page 600



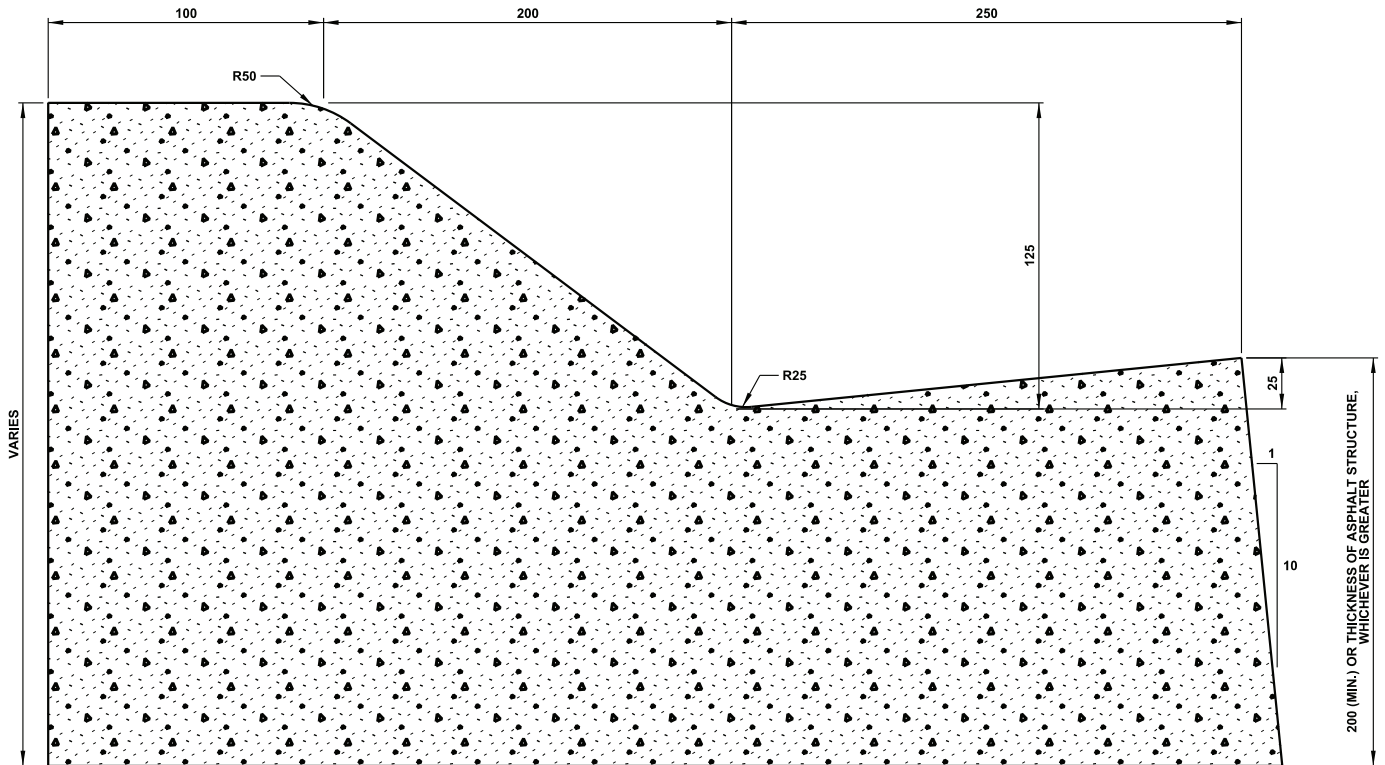

**ALL DIMENSIONS  
IN MILLIMETRES UNLESS  
OTHERWISE NOTED**



STANDARD DRAWING

2023-08-31

**125mm SEMI-MOUNTABLE CURB AND 250mm GUTTER**

DATE APPROVED: **2018**

SCALE: **N.T.S.**

DRAWN BY: **KSYC**

CHECKED BY: **JN**

APPROVED: *M.A.R.*

DRAWING NUMBER:

**5023**

v05

Page 601

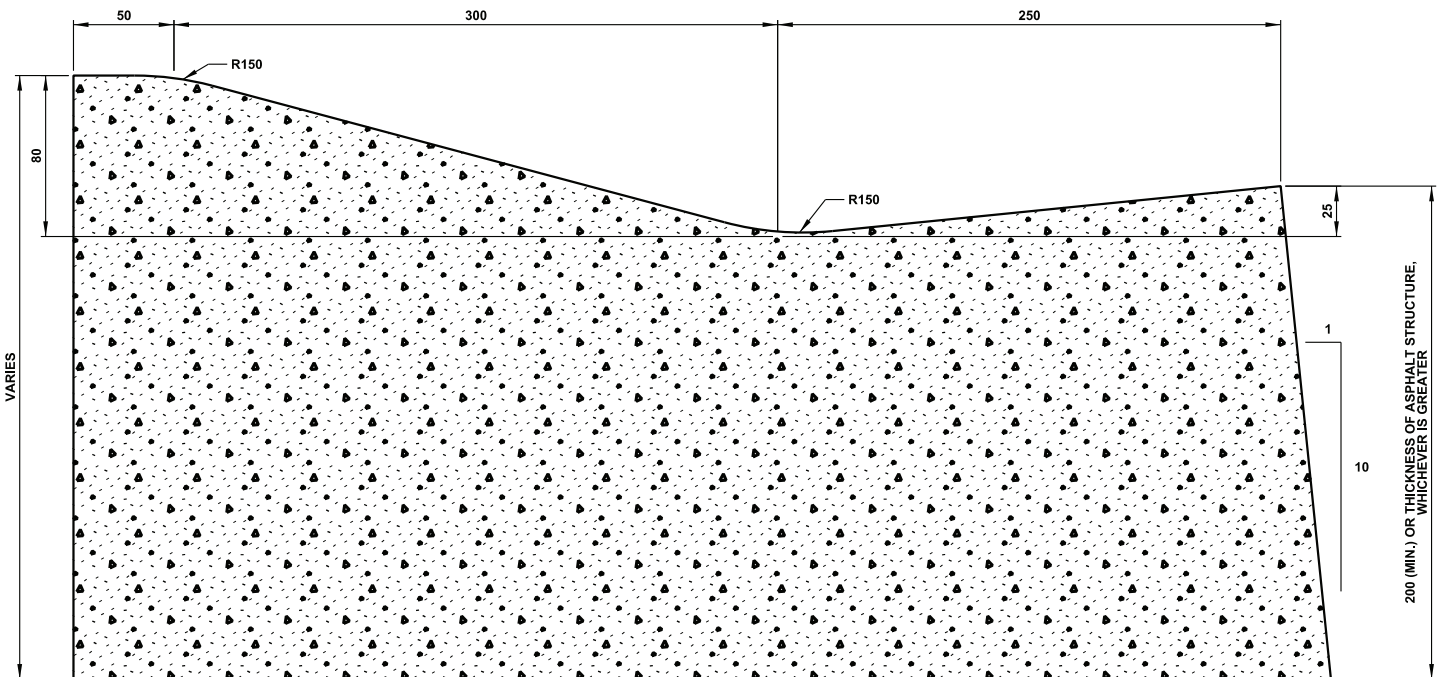

**ALL DIMENSIONS  
IN MILLIMETRES UNLESS  
OTHERWISE NOTED**



STANDARD DRAWING

2023-08-31

**80mm ROLLED MOUNTABLE FACE CURB AND 250mm GUTTER**

DATE APPROVED: **2018**

SCALE: **N.T.S.**

DRAWN BY: **KSYC**

CHECKED BY: **JN**

APPROVED: *M.A.R.*

DRAWING NUMBER:

**5024**

v05

Page 602

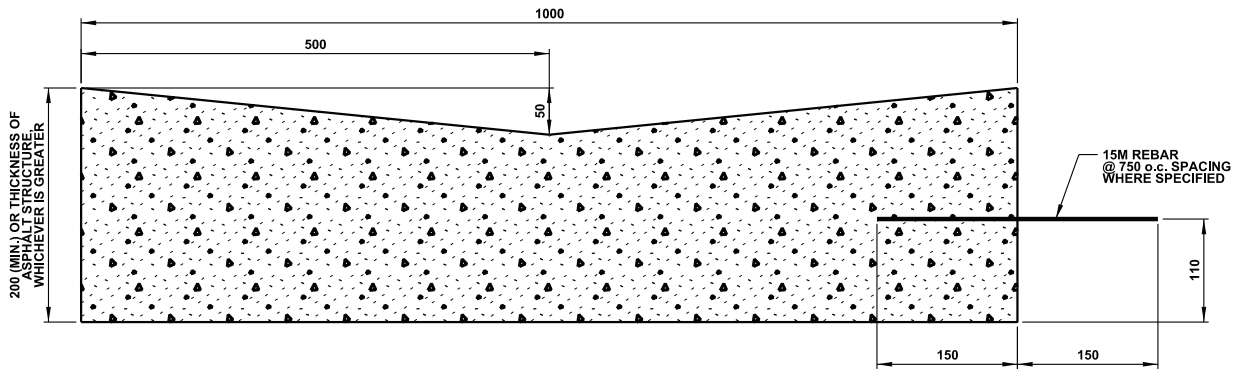

1000mm CONCRETE V-GUTTERS

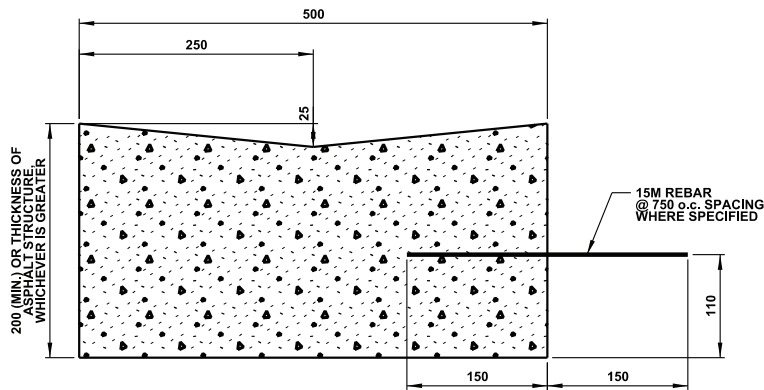

500mm CONCRETE V-GUTTERS

NOTES:

1. IF APPLICABLE, REBAR TO BE DOWELLED INTO NEIGHBOURING STRUCTURE.

**ALL DIMENSIONS  
IN MILLIMETRES UNLESS  
OTHERWISE NOTED**

500mm / 1000mm CONCRETE V-GUTTERS



STANDARD DRAWING

DATE APPROVED: **2018**

DRAWN BY: **KSYC**

APPROVED: *M.L.R.*

DRAWING NUMBER: **5030**

SCALE: **N.T.S.**

CHECKED BY: **JN**

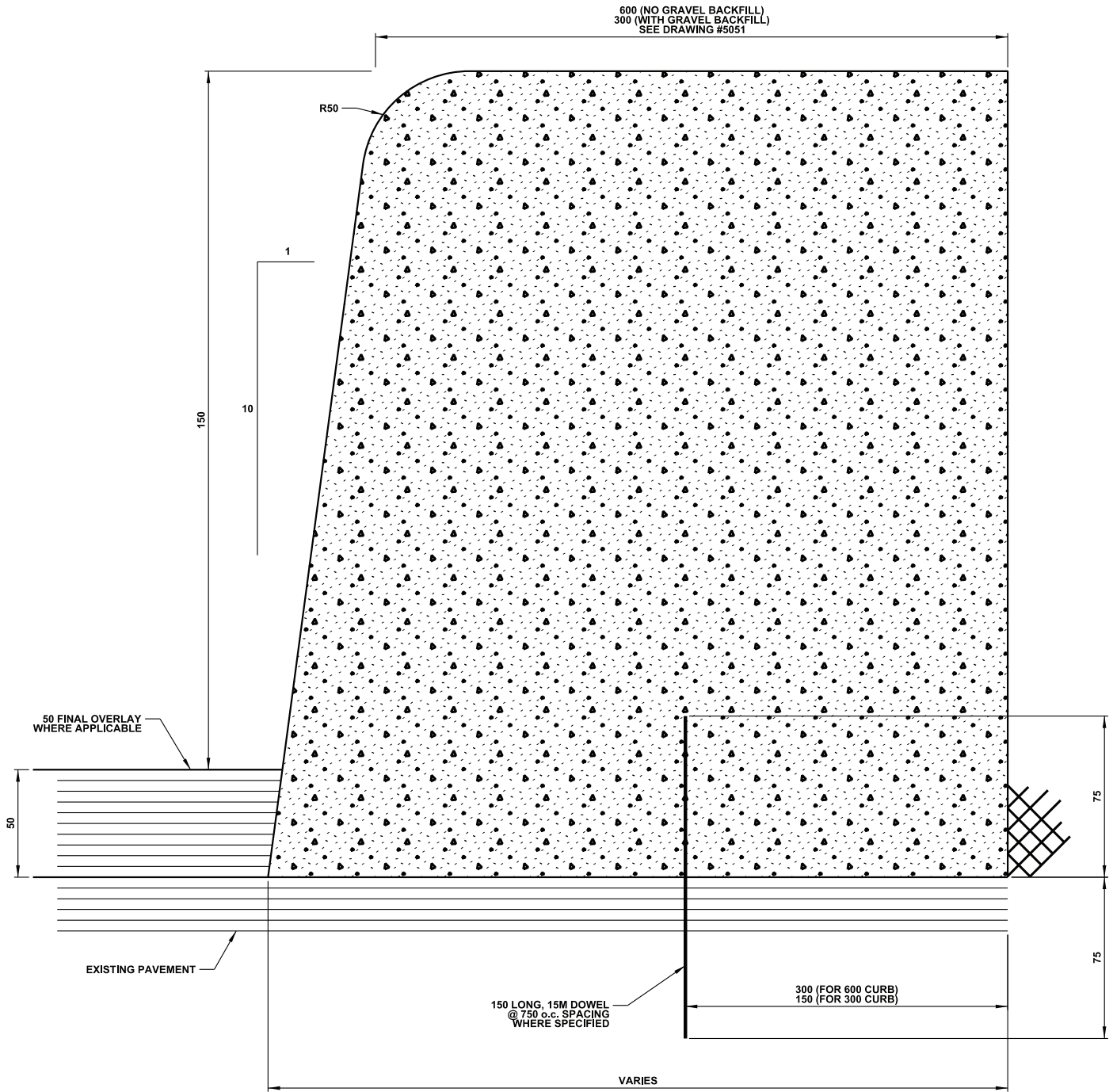

NOTES:

1. EXPOSED FACE OF CURB TO BE 150mm.
2. THIS METHOD OF CONSTRUCTION CANNOT BE USED UNLESS AUTHORIZED BY CITY OF EDMONTON.

**ALL DIMENSIONS  
IN MILLIMETRES UNLESS  
OTHERWISE NOTED**



STANDARD DRAWING

2023-08-31

CONCRETE BARRIER CURB

DATE APPROVED: 2018

DRAWN BY: KSYC

APPROVED: *M.L.R.*

DRAWING NUMBER: 5040

SCALE: N.T.S.

CHECKED BY: JN

v05

Page 604

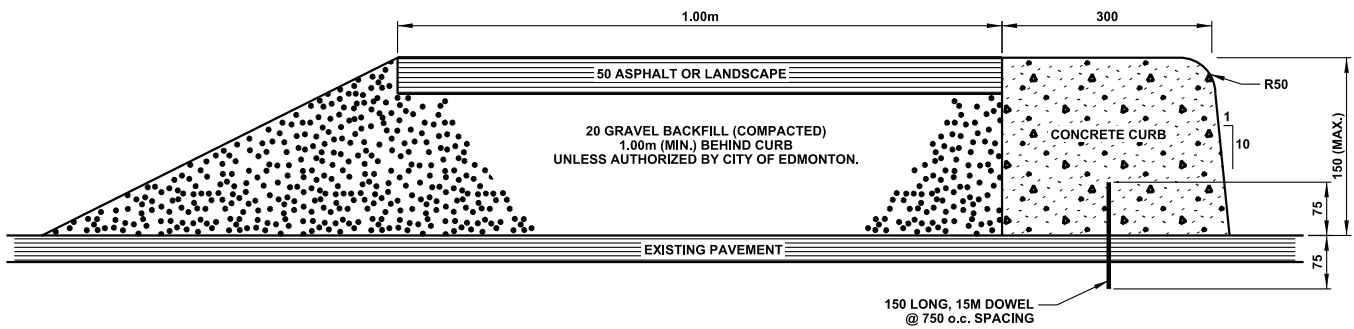
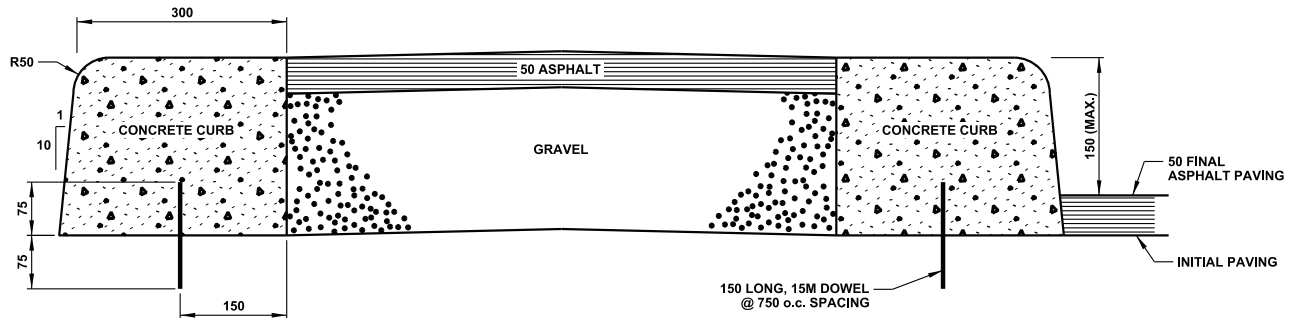

**NOTES:**

1. MAXIMUM EXPOSED FACE OR CURB TO BE 150mm.
2. INCREASE WIDTH OF CONCRETE CURB TO 600 IF NO GRAVEL BACKFILL AND ASPHALT TOPPING.
3. CONCRETE CURB DETAIL SEE DRAWING #5040.

**ALL DIMENSIONS  
IN MILLIMETERS UNLESS  
OTHERWISE NOTED**



2023-08-31

**TEMPORARY SLAB-ON CONCRETE CURB**

DATE APPROVED: **2018**  
SCALE: **N.T.S.**

DRAWN BY: **KSYC**  
CHECKED BY: **JN**

APPROVED: *M.A.R.*

DRAWING NUMBER: **5051**

v05

Page 605

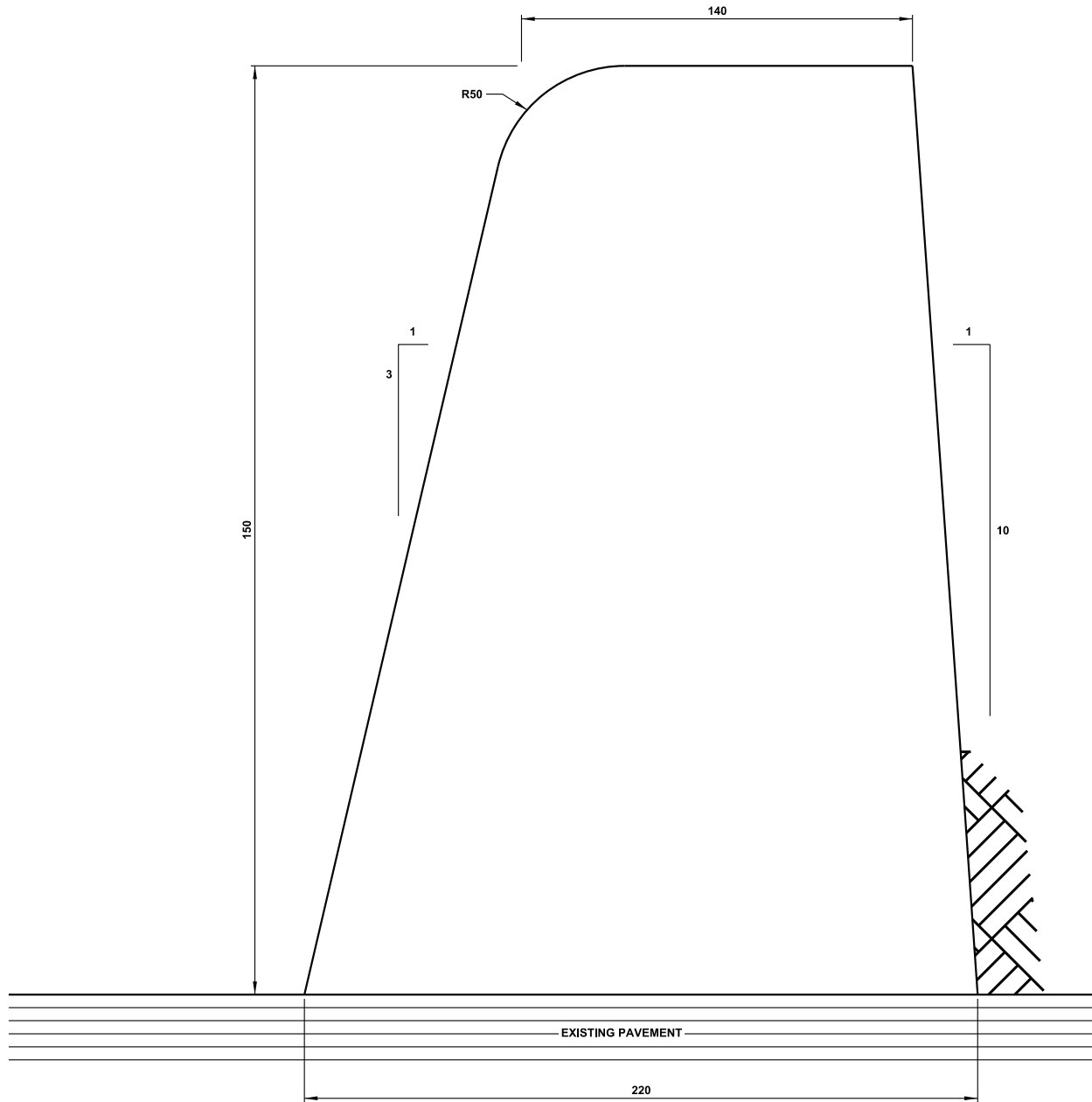

**ALL DIMENSIONS  
IN MILLIMETRES UNLESS  
OTHERWISE NOTED**

**TEMPORARY SLAB-ON ASPHALT CURB**



STANDARD DRAWING

DATE APPROVED: **2018**

DRAWN BY: **KSYC**

APPROVED: *M.A.R.*

DRAWING NUMBER: **5052**

SCALE: **N.T.S.**

CHECKED BY: **JN**

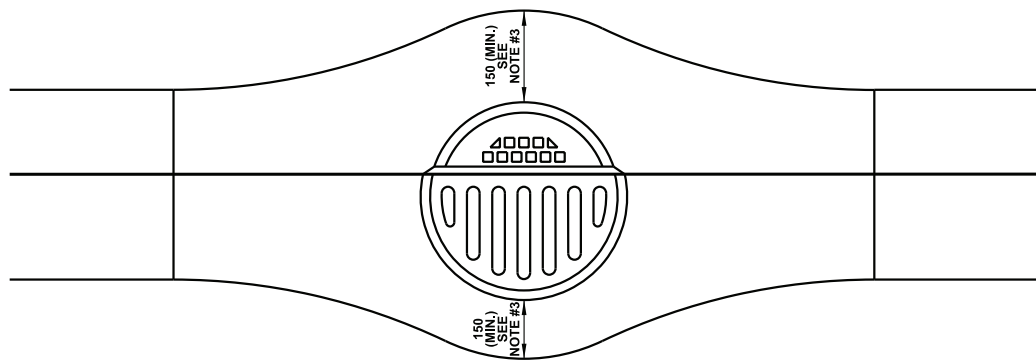
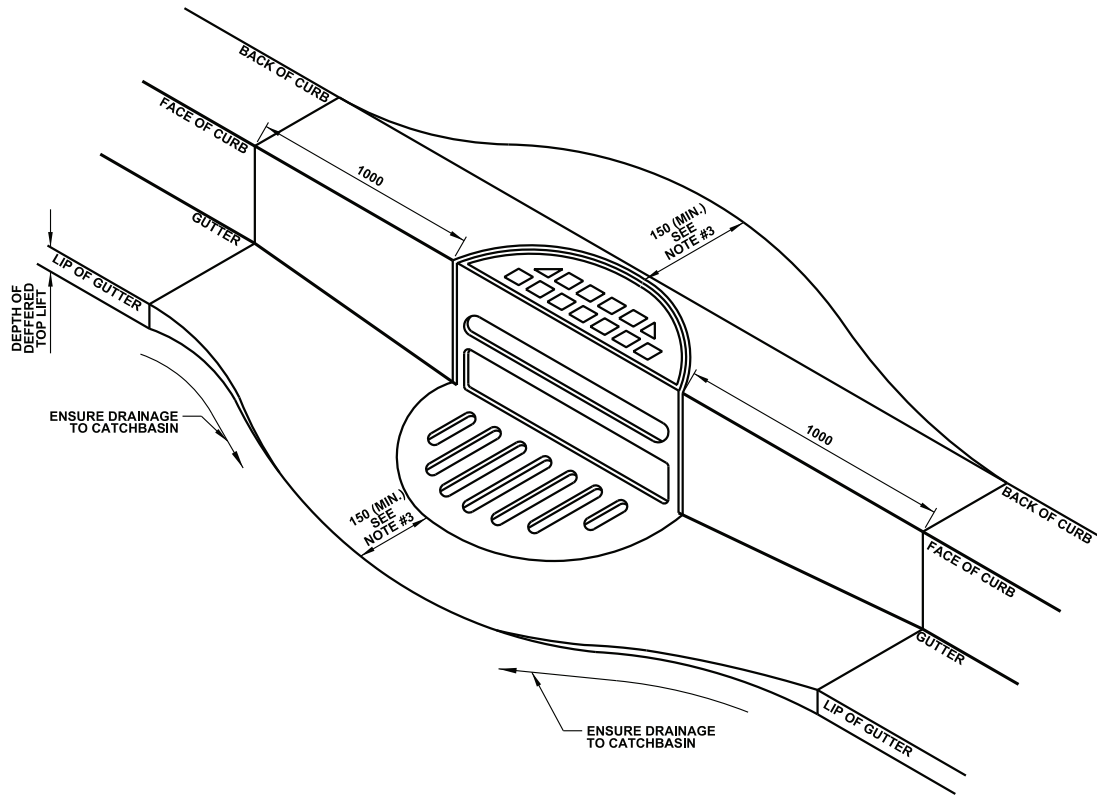

PLAN VIEW

NOTES:

1. TYPICAL CURB AND GUTTER TREATMENT AT CATCHBASIN WHEN ASPHALT TOP LIFT IS DEFERRED. LOCATION TO BE DETERMINED BY ENGINEER.
2. 0.50% (MIN.) FOR 5.00m EACH DIRECTION ON SAG VERTICAL CURVE.
3. MINIMUM OFFSET DISTANCE FROM EDGE OF CURB TO CATCHBASIN ARE MEASURED FROM EDGE OF CATCHBASIN BARREL / RINGS. SEE CITY OF EDMONTON DESIGN STANDARD CHAPTER 3 DRAINAGE DRAWINGS.

**ALL DIMENSIONS  
IN MILLIMETRES UNLESS  
OTHERWISE NOTED**



STANDARD DRAWING

**DEPRESSED CURB AND GUTTER FOR CATCHBASIN**

DATE APPROVED: **2018**

SCALE: **N.T.S.**

DRAWN BY: **KSYC**

CHECKED BY: **JN**

APPROVED: *M.A.R.*

DRAWING NUMBER: **5060**

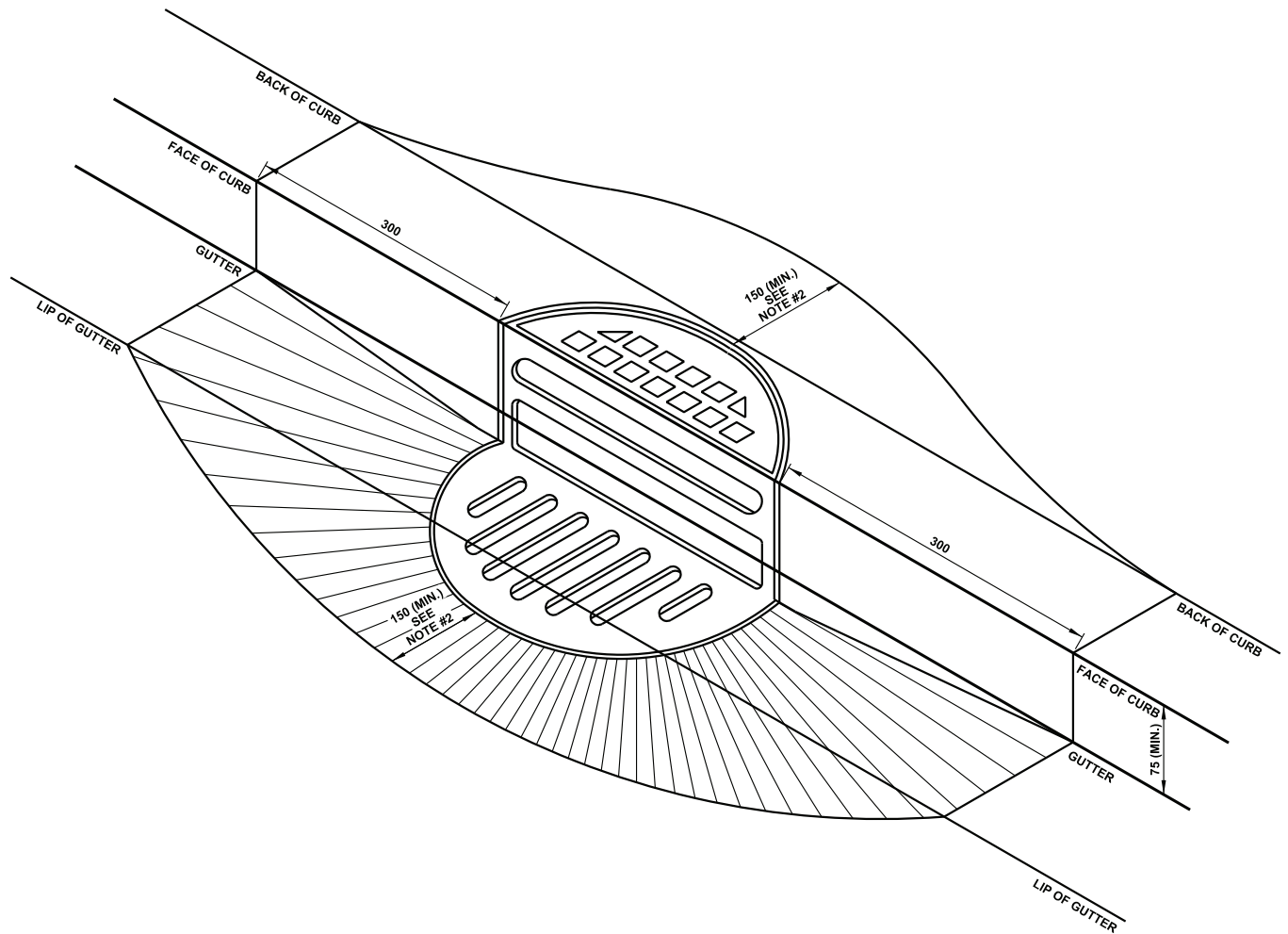

NOTES:

- 1. TYPICAL ASPHALT GRADING AROUND CATCH BASINS WITH 50.00 OVERLAYS IN GUTTERS.

**ALL DIMENSIONS  
IN MILLIMETRES UNLESS  
OTHERWISE NOTED**

Edmonton  
STANDARD DRAWING

**CATCHBASIN TREATMENT 50mm OVERLAY OF GUTTER**

DATE APPROVED: **2018**  
SCALE: **N.T.S.**

DRAWN BY: **KSYC**  
CHECKED BY: **JN**

APPROVED: *M.A.R.*

DRAWING NUMBER: **5061**



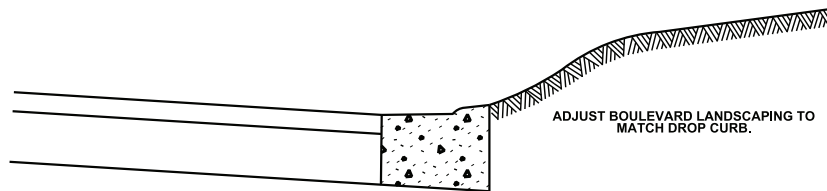
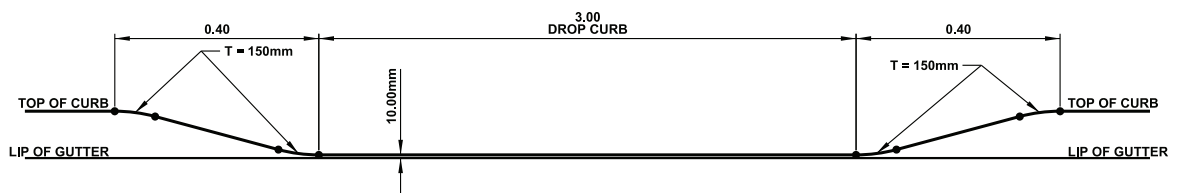
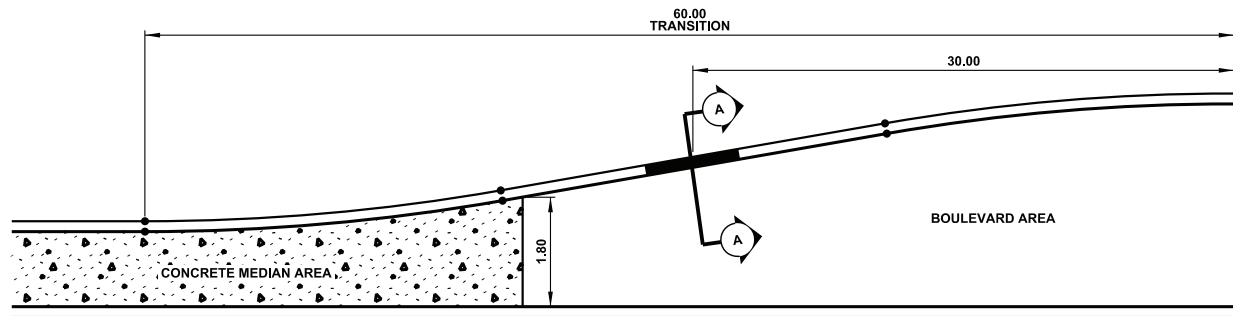

CROSS SECTION A-A

**ALL DIMENSIONS  
IN METRES UNLESS  
OTHERWISE NOTED**



STANDARD DRAWING

2023-08-31

**LAWN MOWER ACCESS TO MEDIAN**

DATE APPROVED: **2018**

DRAWN BY: **KSYC**

APPROVED: *M.R.*

DRAWING NUMBER: **5070**

SCALE: **N.T.S.**

CHECKED BY: **JN**

v05

Page 609



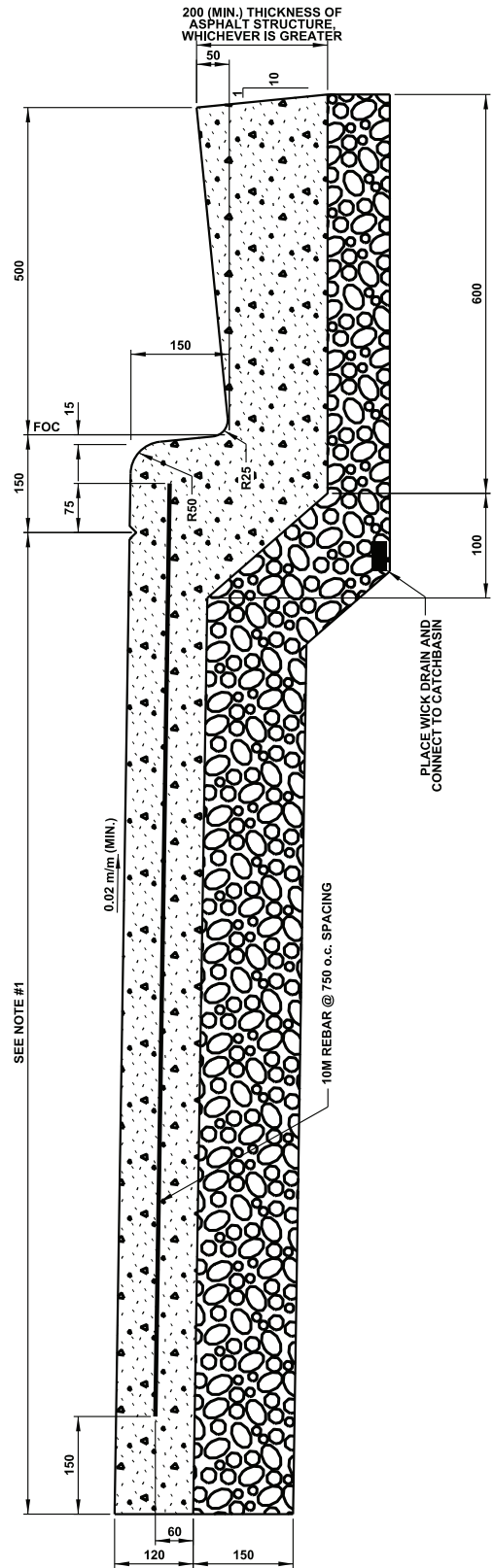

NOTES:

1. MINIMUM WIDTH OF MONOWALK
  - ON URBAN LOCAL ROADWAYS TO BE 1.80m.
  - ALONG COLLECTOR / ARTERIAL ROADWAYS TO BE 2.30m.
  - IN FRONT OF SCHOOL SITE TO BE 2.50m.

**ALL DIMENSIONS  
IN MILLIMETRES UNLESS  
OTHERWISE NOTED**



STANDARD DRAWING

2023-08-31

**MONOLITHIC WALK WITH 150mm CURB AND 500mm GUTTER (RETROFIT)**

DATE APPROVED: **2018**

DRAWN BY: **KSYC**

APPROVED: *M.A.R.*

DRAWING NUMBER: **5110**

SCALE: **N.T.S.**

CHECKED BY: **JN**

v05

Page 611

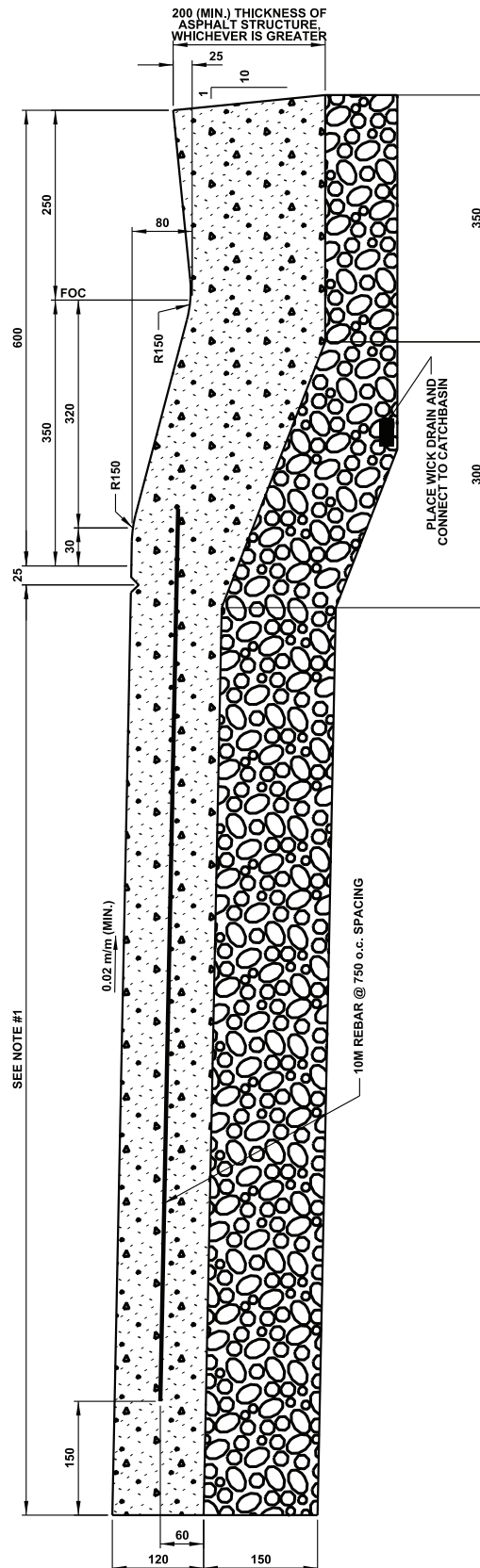

NOTES:

- MINIMUM WIDTH OF MONOWALK**
  - ON URBAN LOCAL ROADWAYS TO BE 1.80m.
  - ALONG COLLECTOR / ARTERIAL ROADWAYS TO BE 2.30m.
  - IN FRONT OF SCHOOL SITE TO BE 2.50m.

**ALL DIMENSIONS  
IN MILLIMETRES UNLESS  
OTHERWISE NOTED**



STANDARD DRAWING

2023-08-31

**ROLLED FACE MONOLITHIC WALK AND GUTTER**

DATE APPROVED: **2018**

SCALE: **N.T.S.**

DRAWN BY: **KSYC**

CHECKED BY: **JN**

APPROVED:

DRAWING NUMBER:

**5120**

v05

Page 612

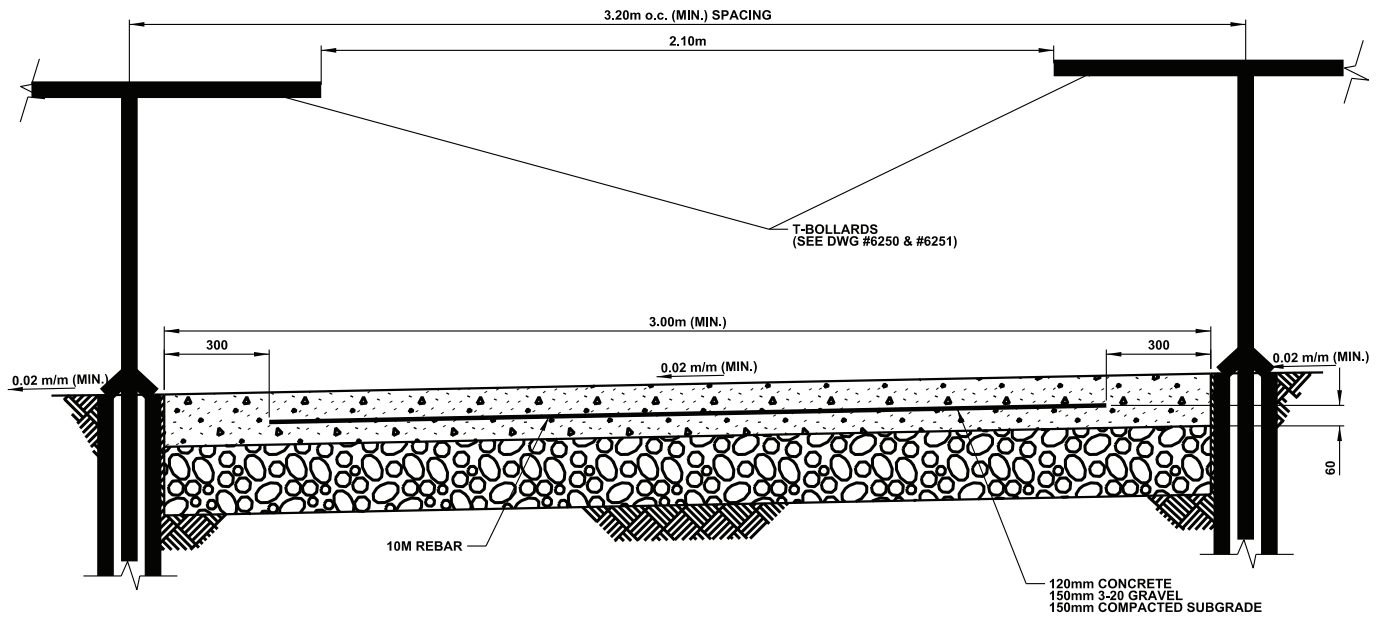

TYPICAL SECTION

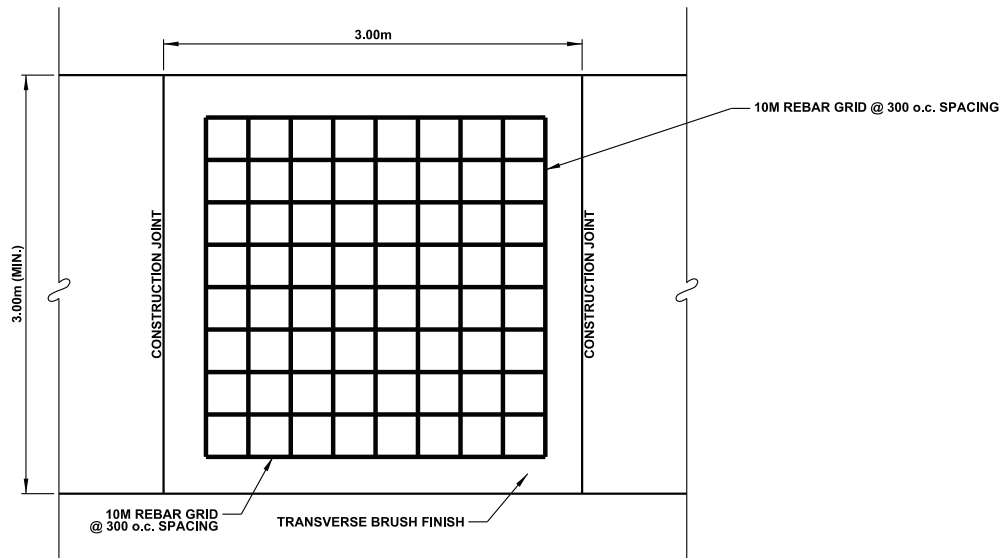

PLAN VIEW

NOTES:

1. T-BOLLARDS REQUIREMENT ARE UNDER DISCRETION OF CITY OF EDMONTON.
2. WIRE MESH WILL NOT BE CONSIDERED AS AN ALTERNATIVE.

**ALL DIMENSIONS  
IN MILLIMETRES UNLESS  
OTHERWISE NOTED**



STANDARD DRAWING

**EMERGENCY ACCESS ROAD  
CONCRETE**

DATE APPROVED: **2018**  
SCALE: **N.T.S.**

DRAWN BY: **KSYC**  
CHECKED BY: **JN**

APPROVED: *M.A.R.*

DRAWING NUMBER: **5130**

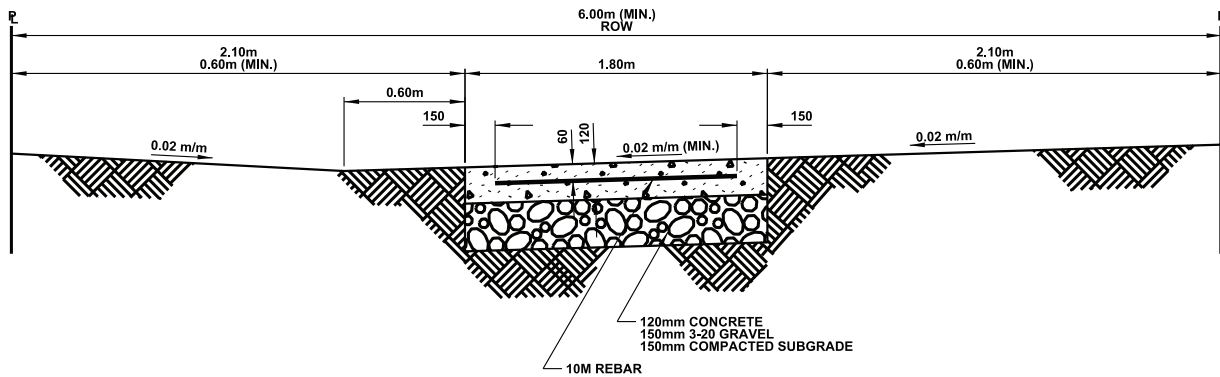

TYPICAL SECTION

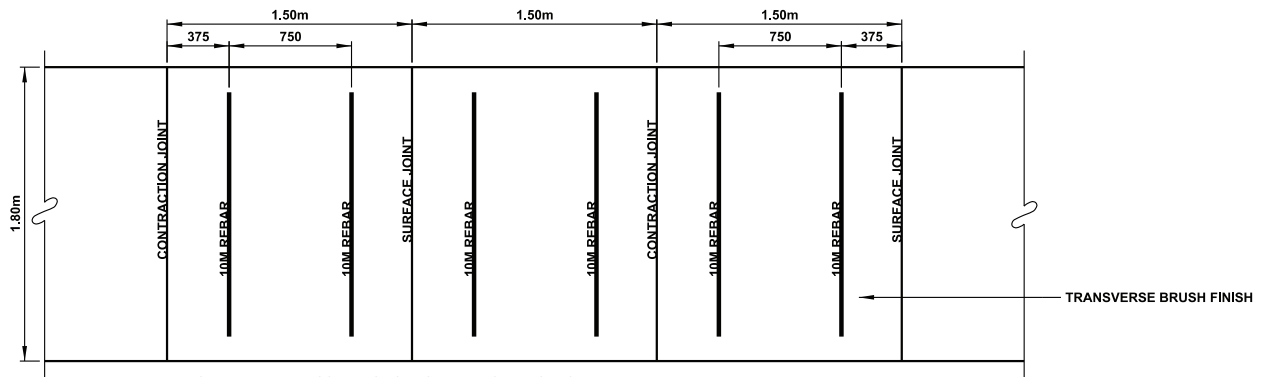

TYPICAL PLAN VIEW

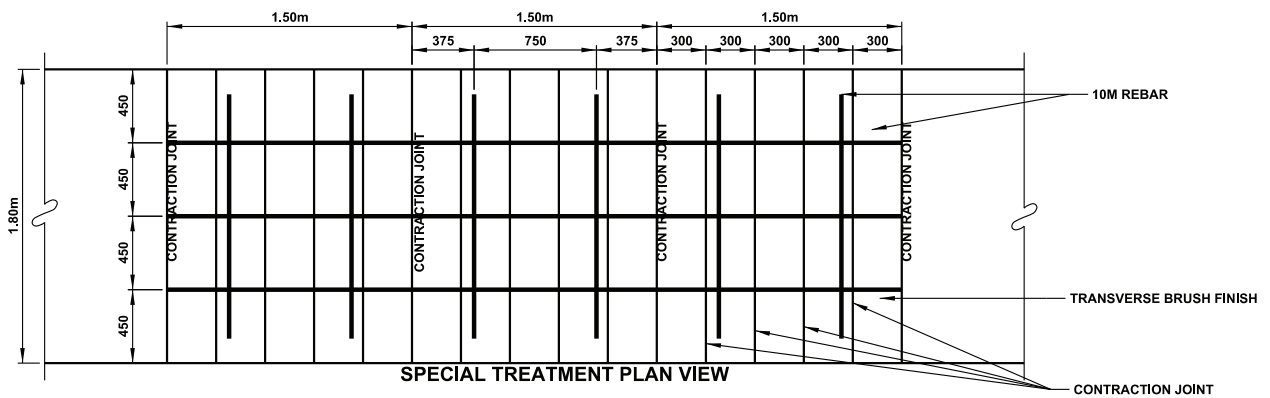

SPECIAL TREATMENT PLAN VIEW

NOTES:

1. ALTERNATE CONTRACTION JOINT AND SURFACE JOINT FOR TYPICAL CONCRETE WALKWAY CONSTRUCTION.
2. SPECIAL TREATMENT ADJACENT TO EXISTING TREES AS REQUESTED BY ENGINEER.
3. USE ALL CONTRACTION JOINTS WITHIN SPECIAL TREATMENT AREA.
4. LONGITUDINAL REBARS MUST BE CONTINUOUS AND TIED TO THE TRANSVERSE REBARS.

**ALL DIMENSIONS  
IN MILLIMETRES UNLESS  
OTHERWISE NOTED**



**CONCRETE WALKWAY - 1.80m**

DATE APPROVED: **2018**  
SCALE: **N.T.S.**

DRAWN BY: **KSYC**  
CHECKED BY: **JN**

APPROVED: *M.R.*

DRAWING NUMBER: **5140**

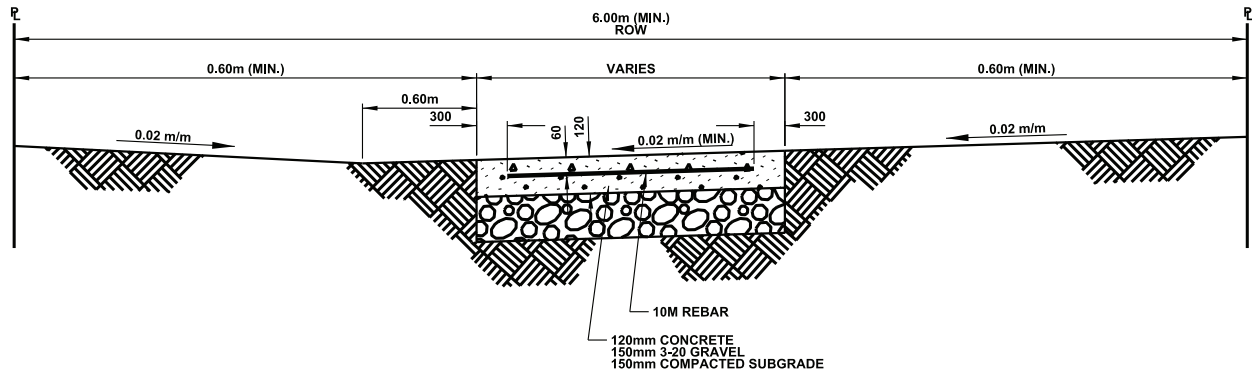

TYPICAL SECTION

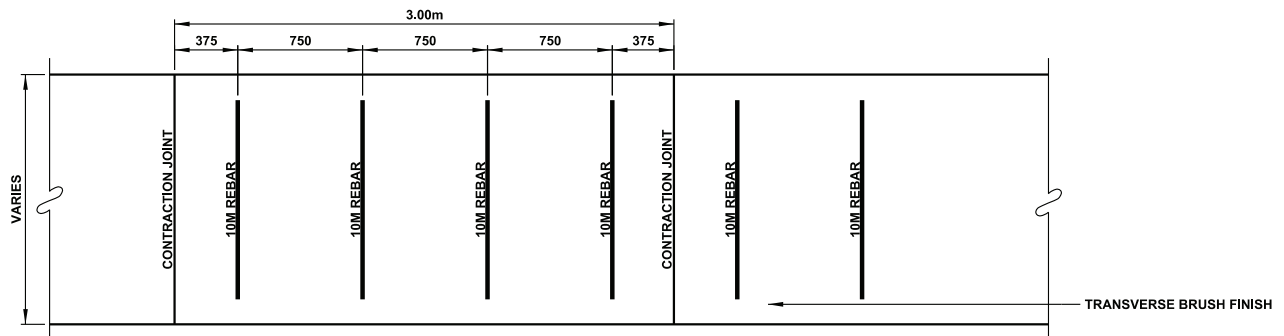

PLAN VIEW

**ALL DIMENSIONS  
IN MILLIMETRES UNLESS  
OTHERWISE NOTED**



STANDARD DRAWING

2023-08-31

**CONCRETE WALKWAY - GREATER THAN 1.80m**

DATE APPROVED: **2018**

SCALE: **N.T.S.**

DRAWN BY: **KSYC**

CHECKED BY: **JN**

APPROVED: *M.A.R.*

DRAWING NUMBER:

**5150**

v05

Page 615

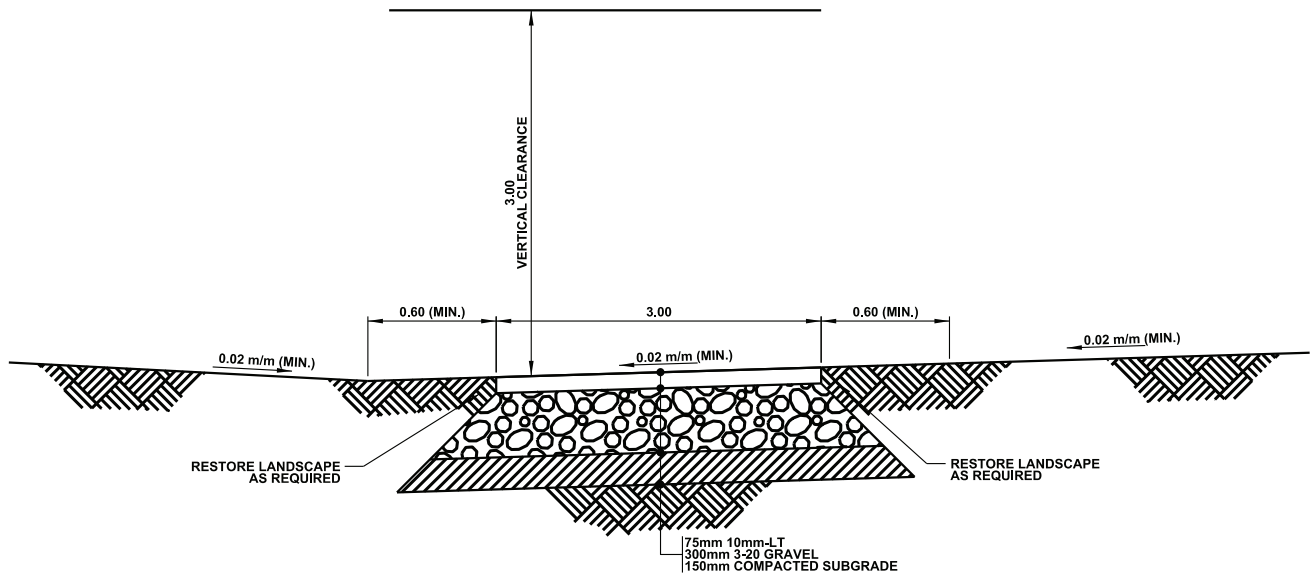

TYPICAL SECTION

ALTERNATE STRUCTURE:

- 75mm 10mm-LT
- 300mm 3-20 GRAVEL ON CLASS 2 WOVEN GEOTEXTILE FABRIC NILEX 2002
- OR
- OR LAYFIELD LP200
- OR EQUIVALENT EXTENDED UP EDGES OF GRAVEL ON NATIVE GROUND

NOTE:

FOR 3.00m SHARED USE PATH WIDTH, 100mm SOLID YELLOW CENTER LINE IS REQUIRED AT THE DISCRETION OF CITY OF EDMONTON.

**ALL DIMENSIONS  
IN METRES UNLESS  
OTHERWISE NOTED**



STANDARD DRAWING

**SHARED USE PATH**

DATE APPROVED: **2018**

DRAWN BY: **KSYC**

APPROVED: *M.A.R.*

DRAWING NUMBER: **5160**

SCALE: **N.T.S.**

CHECKED BY: **JN**



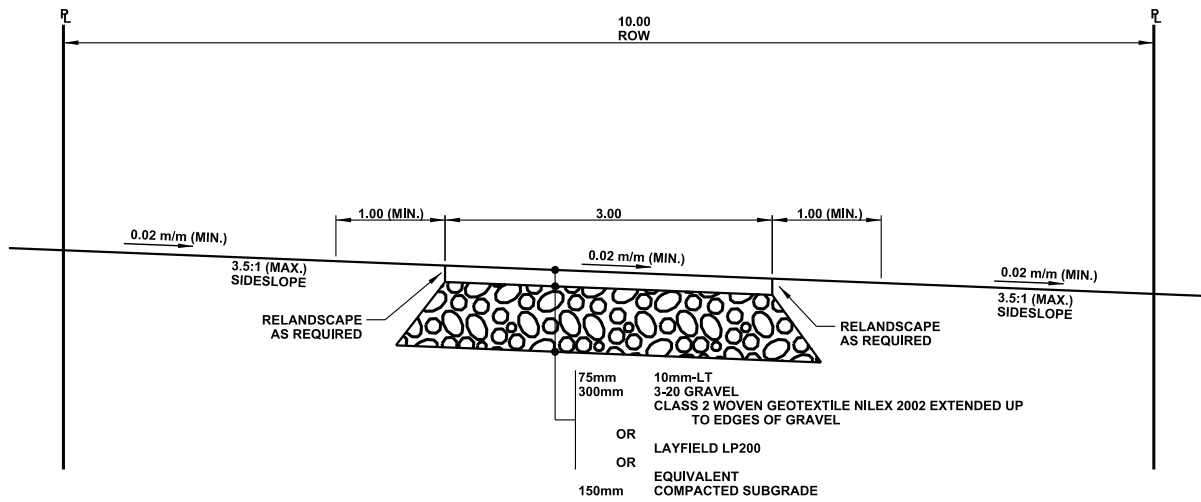

TYPICAL CROSS SECTION

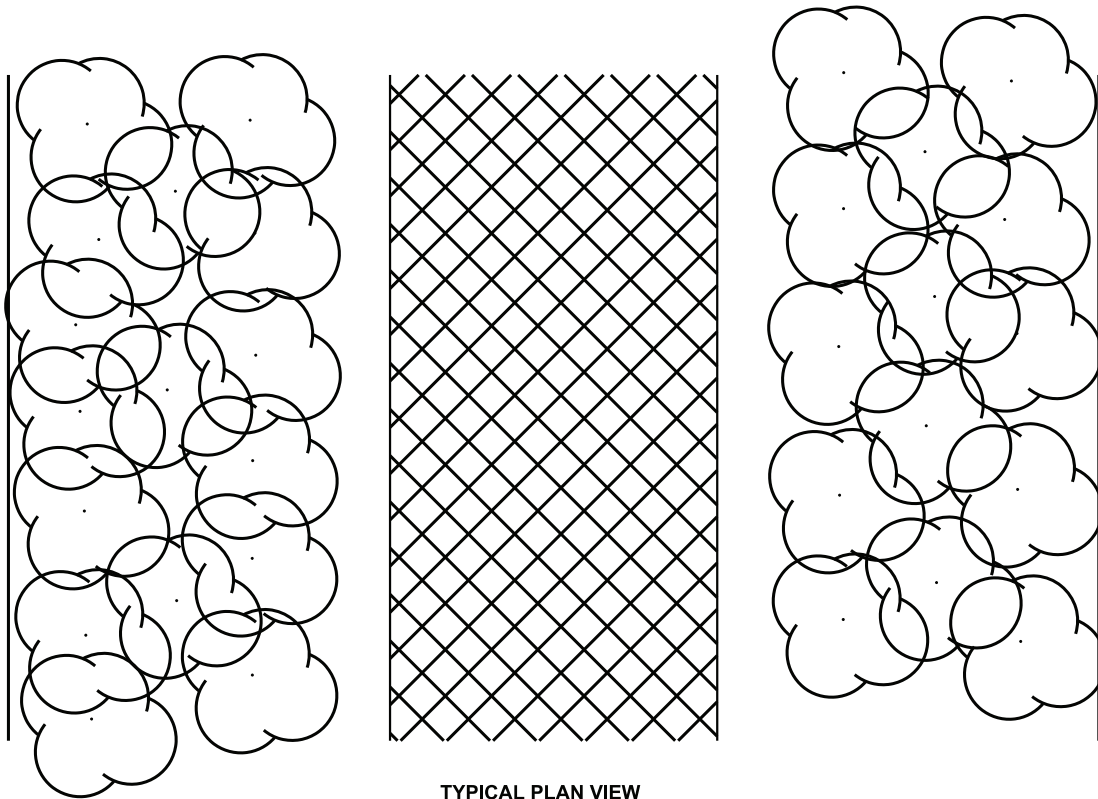

NOTE:

FOR 3.00m OR GREATER SHARED USE PATH WIDTH, 100mm SOLID YELLOW CENTER LINE IS REQUIRED AT THE DISCRETION OF CITY OF EDMONTON.

ALL DIMENSIONS  
IN METRES UNLESS  
OTHERWISE NOTED

TOP OF BANK TRAIL



STANDARD DRAWING

DATE APPROVED: 2018

DRAWN BY: KSYC

APPROVED: *M.A.R.*

DRAWING NUMBER: 5165

SCALE: N.T.S.

CHECKED BY: JN

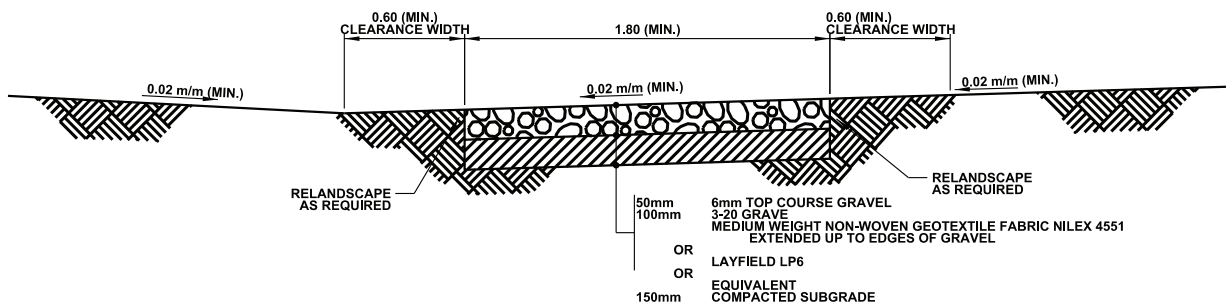

TYPICAL SECTION

ALTERNATE STRUCTURE:

- 50mm 6mm TOP COURSE GRAVEL
  - 250mm 3-20 GRAVEL  
CLASS 2 NON-WOVEN GEOTEXTILE NILEX 4551  
EXTENDED UP TO EDGES OF GRAVEL ON NATIVE GROUND
- OR  
LAYFIELD LP6
- OR  
EQUIVALENT

ALL DIMENSIONS  
IN METRES UNLESS  
OTHERWISE NOTED



STANDARD DRAWING

2023-08-31

GRANULAR WALKWAY

DATE APPROVED: 2018

DRAWN BY: KSYC

APPROVED: *M.A.R.*

DRAWING NUMBER: 5170

SCALE: N.T.S.

CHECKED BY: JN

v05

Page 618

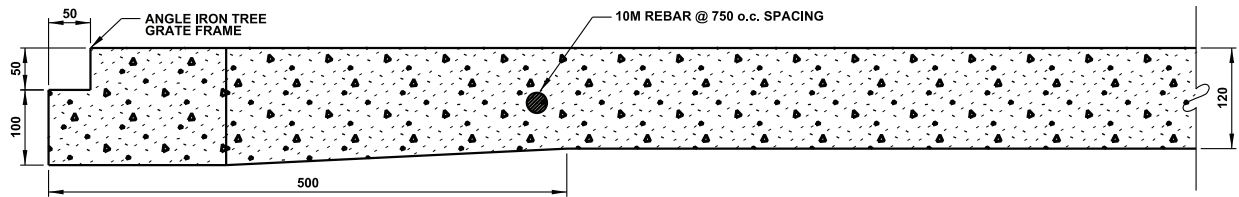
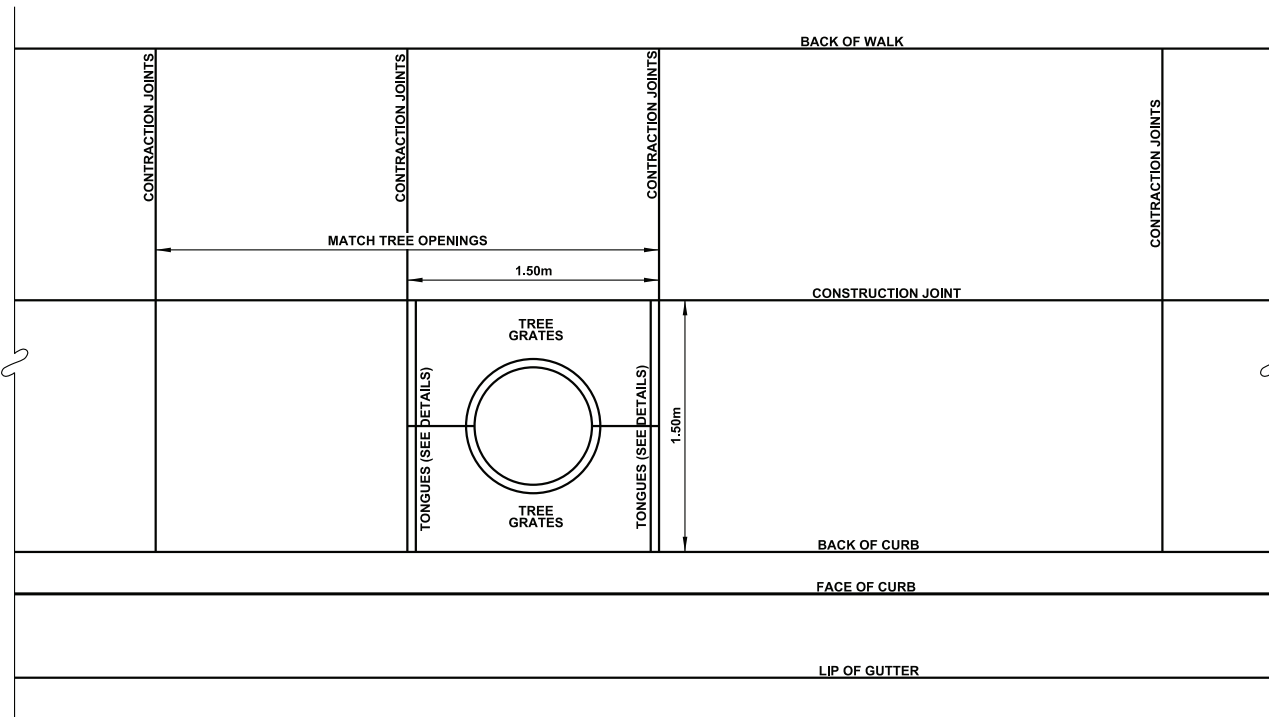

DETAIL OF TONGUE FOR SUPPORT OF TREE GRATES

NOTE:

- 1. GRATE OPENING SHOULD BE SLIGHTLY LESS THAN OPENING.

**ALL DIMENSIONS IN MILLIMETRES UNLESS OTHERWISE NOTED**



STANDARD DRAWING

2023-08-31

**SIDEWALK CONSTRUCTION AT TREE OPENING**

DATE APPROVED: **2018**

DRAWN BY: **KSYC**

APPROVED: *M.A.R.*

DRAWING NUMBER: **5180**

SCALE: **N.T.S.**

CHECKED BY: **JN**

v05

Page 619

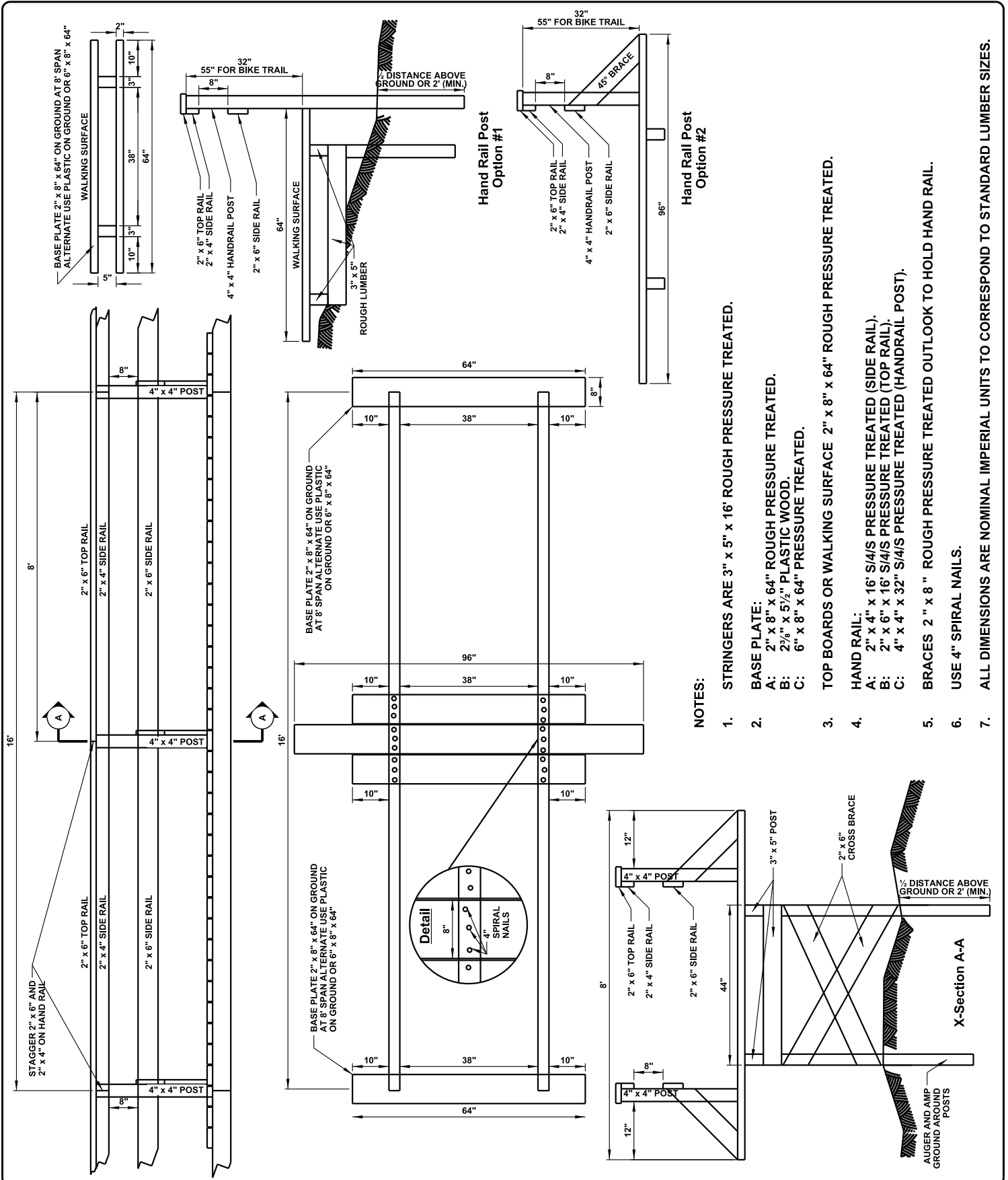

**NOTES:**

1. STRINGERS ARE 3" x 5" x 16' ROUGH PRESSURE TREATED.
2. BASE PLATE:
  - A: 2" x 8" x 64" ROUGH PRESSURE TREATED.
  - B: 2<sup>5</sup>/<sub>8</sub>" x 5<sup>1</sup>/<sub>2</sub>" PLASTIC WOOD.
  - C: 6" x 8" x 64" PRESSURE TREATED.
3. TOP BOARDS OR WALKING SURFACE 2" x 8" x 64" ROUGH PRESSURE TREATED.
4. HAND RAIL:
  - A: 2" x 4" x 16' S4/S PRESSURE TREATED (SIDE RAIL).
  - B: 2" x 6" x 16' S4/S PRESSURE TREATED (TOP RAIL).
  - C: 4" x 4" x 32" S4/S PRESSURE TREATED (HANDRAIL POST).
5. BRACES 2" x 8" ROUGH PRESSURE TREATED OUTLOOK TO HOLD HAND RAIL.
6. USE 4" SPIRAL NAILS.
7. ALL DIMENSIONS ARE NOMINAL IMPERIAL UNITS TO CORRESPOND TO STANDARD LUMBER SIZES.



STANDARD DRAWING

**WOODEN WALK**

DATE APPROVED: <b>2018</b>	DRAWN BY: <b>KSYC</b>	APPROVED: <i>M.A.R.</i>	DRAWING NUMBER: <b>5200</b>
SCALE: <b>N.T.S.</b>	CHECKED BY: <b>JN</b>		

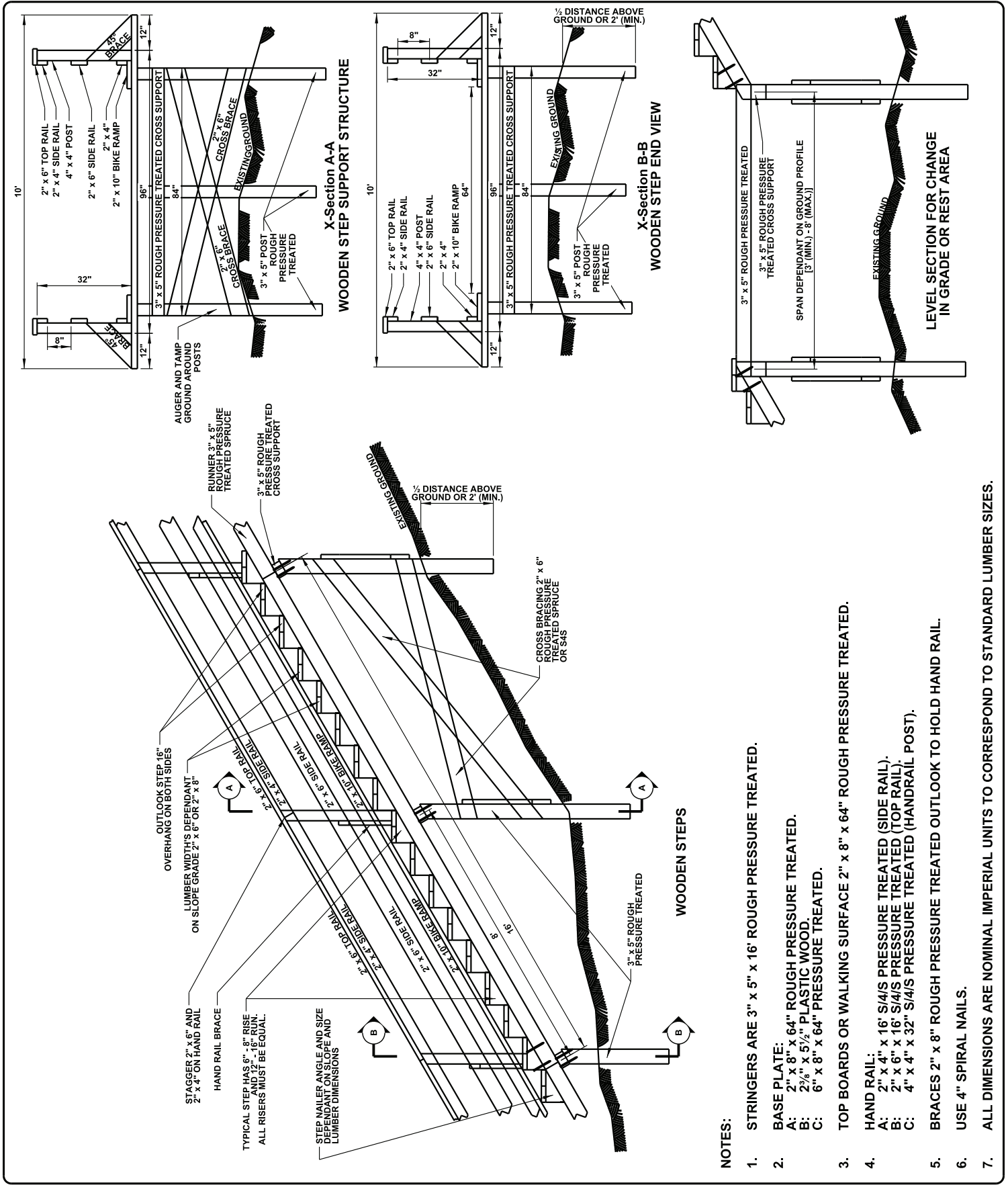

- NOTES:**
1. STRINGERS ARE 3" x 5" x 16' ROUGH PRESSURE TREATED.
  2. BASE PLATE:  
 A: 2" x 8" x 64" ROUGH PRESSURE TREATED.  
 B: 2 3/8" x 5 1/2" PLASTIC WOOD.  
 C: 6" x 8" x 64' PRESSURE TREATED.
  3. TOP BOARDS OR WALKING SURFACE 2" x 8" x 64" ROUGH PRESSURE TREATED.
  4. HAND RAIL:  
 A: 2" x 4" x 16' S/4'S PRESSURE TREATED (SIDE RAIL).  
 B: 2" x 6" x 16' S/4'S PRESSURE TREATED (TOP RAIL).  
 C: 4" x 4" x 32" S/4'S PRESSURE TREATED (HANDRAIL POST).
  5. BRACES 2" x 8" ROUGH PRESSURE TREATED OUTLOOK TO HOLD HAND RAIL.
  6. USE 4" SPIRAL NAILS.
  7. ALL DIMENSIONS ARE NOMINAL IMPERIAL UNITS TO CORRESPOND TO STANDARD LUMBER SIZES.



**WOODEN STAIRS AND SUPPORT STRUCTURE**

DATE APPROVED: <b>2018</b>	DRAWN BY: <b>KSYC</b>	APPROVED: <i>M.R.</i>	DRAWING NUMBER: <b>5201</b>
SCALE: <b>N.T.S.</b>	CHECKED BY: <b>JN</b>		

ALL DIMENSIONS  
IN METRES UNLESS  
OTHERWISE NOTED

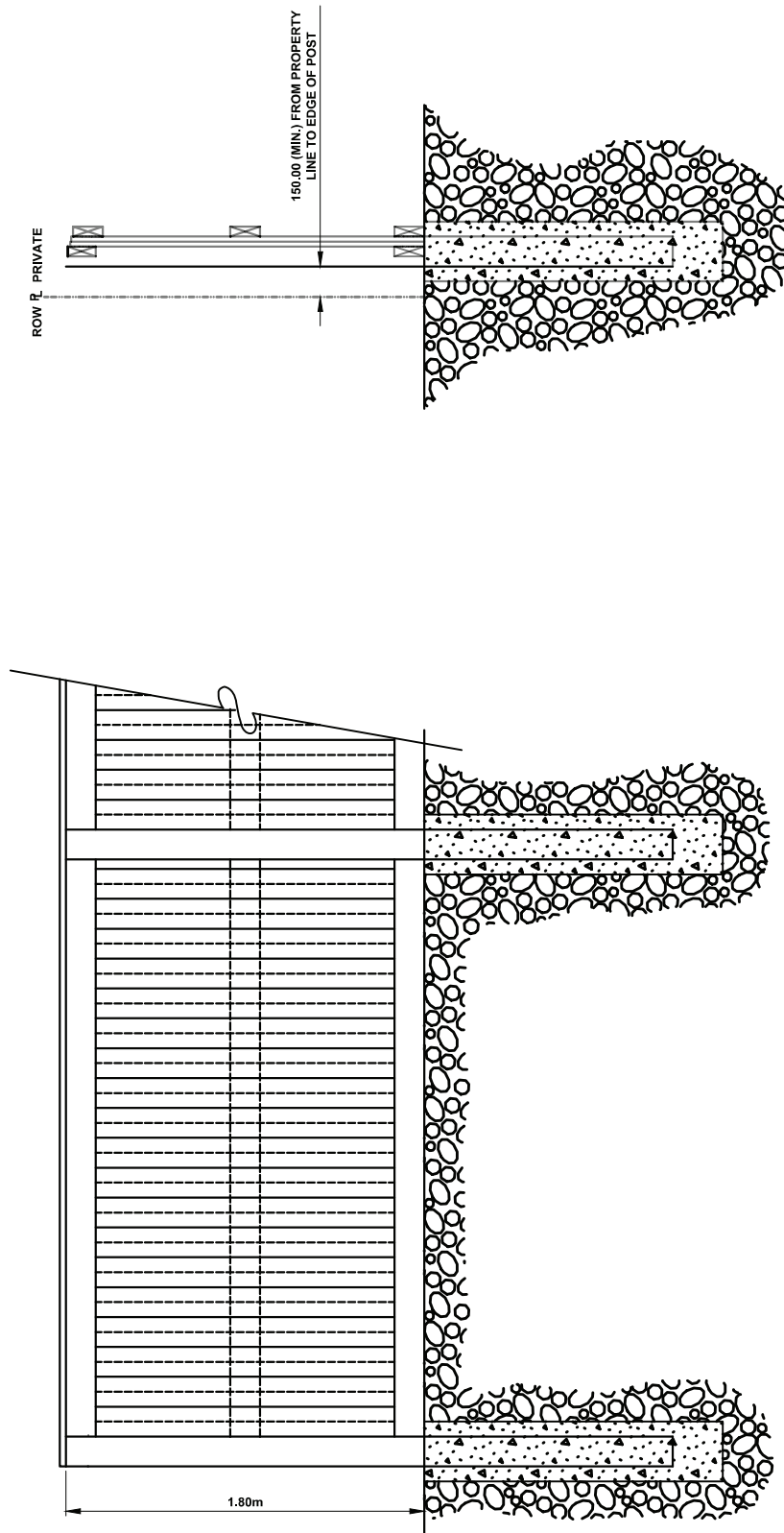
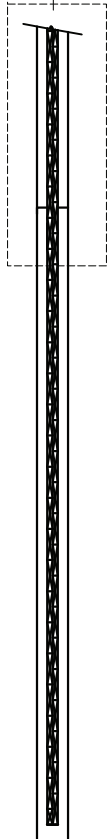
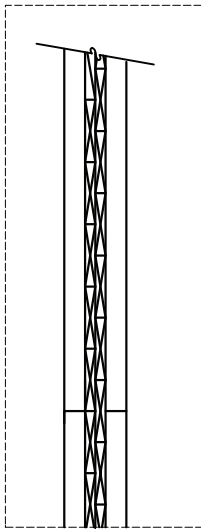

NOTE:

- 1. FENCE DENSITY TO BE 20kg/m<sup>2</sup> WITH NO GAPS.
- 2. NO GAP BETWEEN FINISHED GRADE AND BOTTOM FASER BOARD. MAXIMUM 50mm GAP BETWEEN FINISHED GRADE AND BOTTOM FASER BOARD FOR BACKDRAINING LOT TYPES.

### WOODEN NOISE ATTENUATION FENCE



STANDARD DRAWING

2023-08-31

DATE APPROVED: **2018**

SCALE: **N.T.S.**

DRAWN BY: **KSYC**

CHECKED BY: **JN**

APPROVED: *M.R.*

DRAWING NUMBER: **5205**

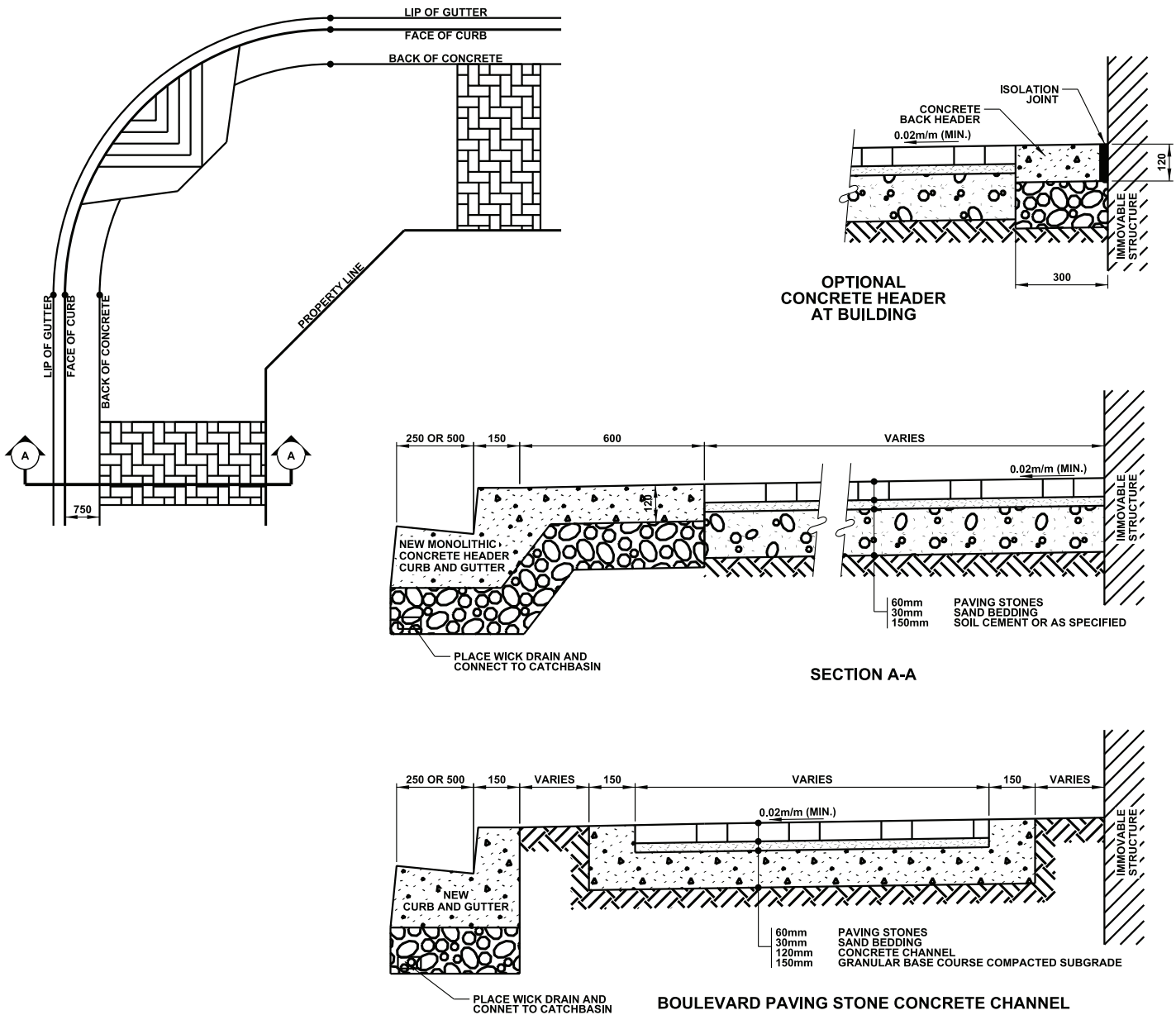

**NOTES:**

1. CURB, GUTTER AND 600mm MOUNTING SLAB POURED MONOLITHICALLY.
2. SIDEWALK X-SLOPE STANDARD TO BE 0.02m/m (MIN.).
3. SIDEWALK X-SLOPE FOR RETROFITTING TO BE 1.00% (MIN.) - 4.00% (MAX.).
4. CURB RAMP TO BE POURED MONOLITHICALLY.
5. SEE DRAWING #5510 FOR CURB RAMP TYPES.

**ALL DIMENSIONS  
IN MILLIMETRES UNLESS  
OTHERWISE NOTED**



STANDARD DRAWING

**PAVING BRICK SIDEWALK CONSTRUCTION**

DATE APPROVED: **2018**

DRAWN BY: **KSYC**

CHECKED BY: **JN**

APPROVED: *M.R.*

DRAWING NUMBER: **5210**

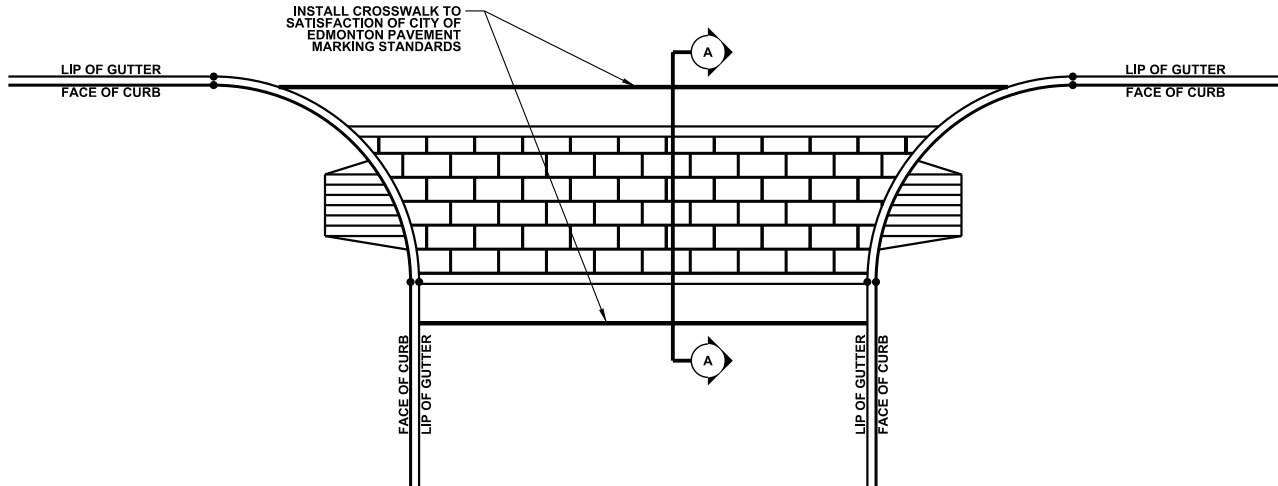

SECTION A-A

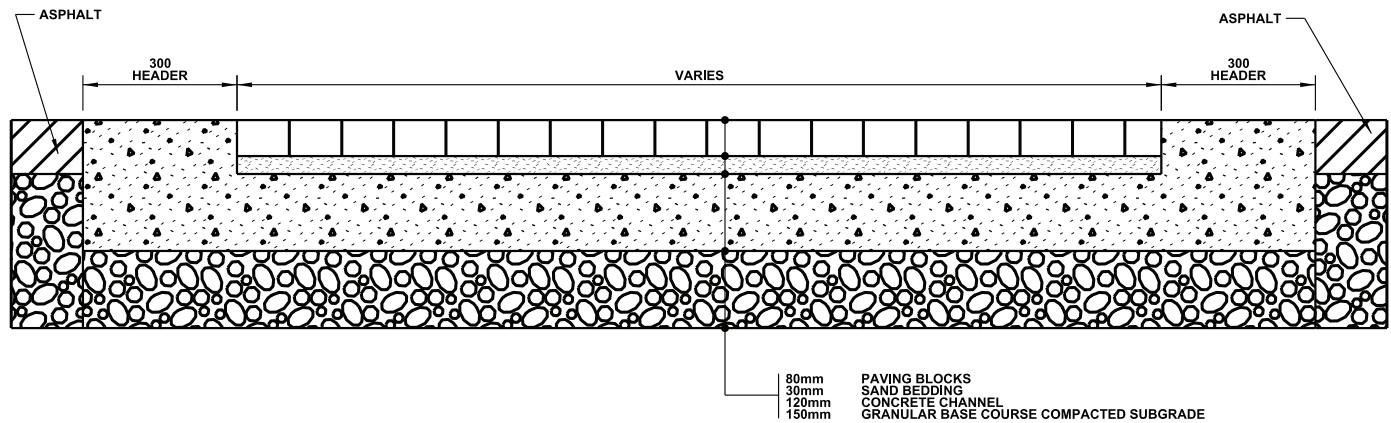

NOTE:

1. WIDTH OF CROSSWALK TO BE 4.00m.
2. WIDTH OF CROSSWALK IN DOWNTOWN AREA TO BE 5.00m.

**ALL DIMENSIONS  
IN MILLIMETRES UNLESS  
OTHERWISE NOTED**



STANDARD DRAWING

## PAVING BRICK CROSSWALK CONSTRUCTION

DATE APPROVED: **2018**

DRAWN BY: **KSYC**

CHECKED BY: **JN**

APPROVED: *M.A.R.*

DRAWING NUMBER: **5215**



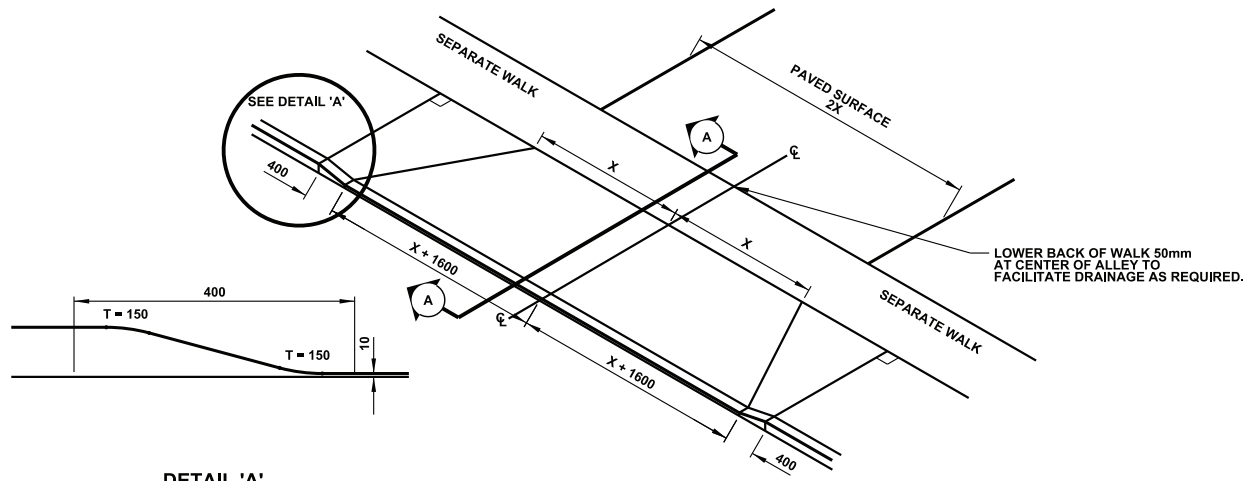

DETAIL 'A'

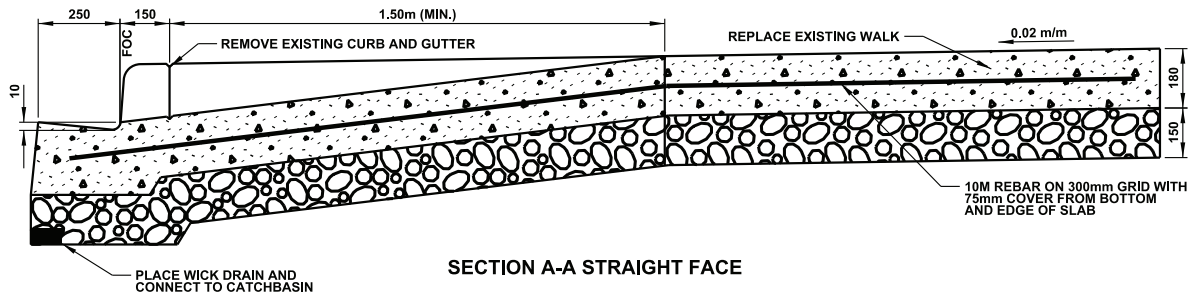

SECTION A-A STRAIGHT FACE

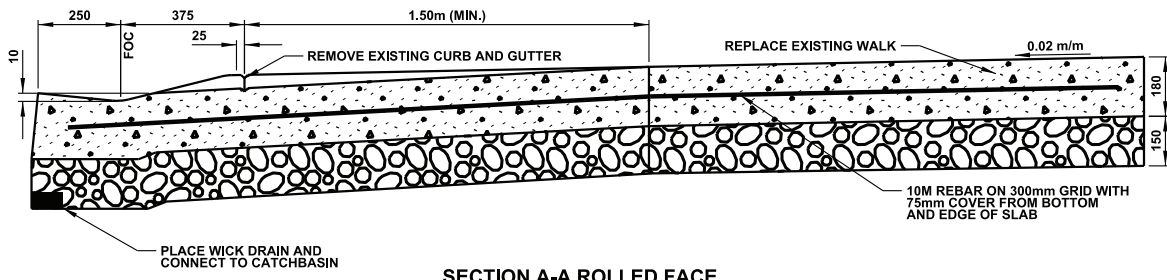

SECTION A-A ROLLED FACE

NOTES:

1. MAXIMUM CROSSFALL SLOPE TO BE 8.00% UNLESS OTHERWISE APPROVED BY ENGINEER.
2. CROSSING MUST BE POURED MONOLITHICALLY WITH CURB AND GUTTER.

**ALL DIMENSIONS  
IN MILLIMETRES UNLESS  
OTHERWISE NOTED**

Edmonton  
STANDARD DRAWING

**ALLEY CROSSING  
BOULEVARD WALK AND APRONS**

DATE APPROVED: **2018**  
SCALE: **N.T.S.**

DRAWN BY: **KSYC**  
CHECKED BY: **JN**

APPROVED: *M.L.R.*

DRAWING NUMBER: **5300**

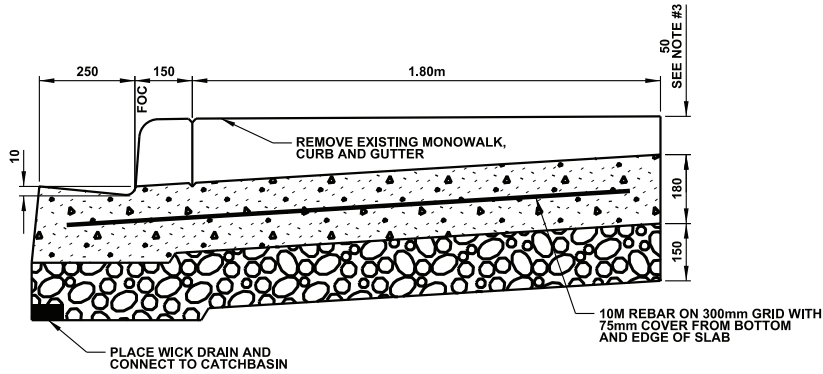
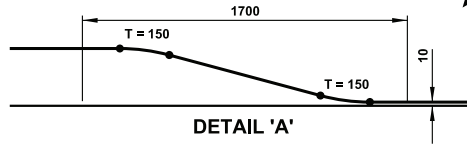
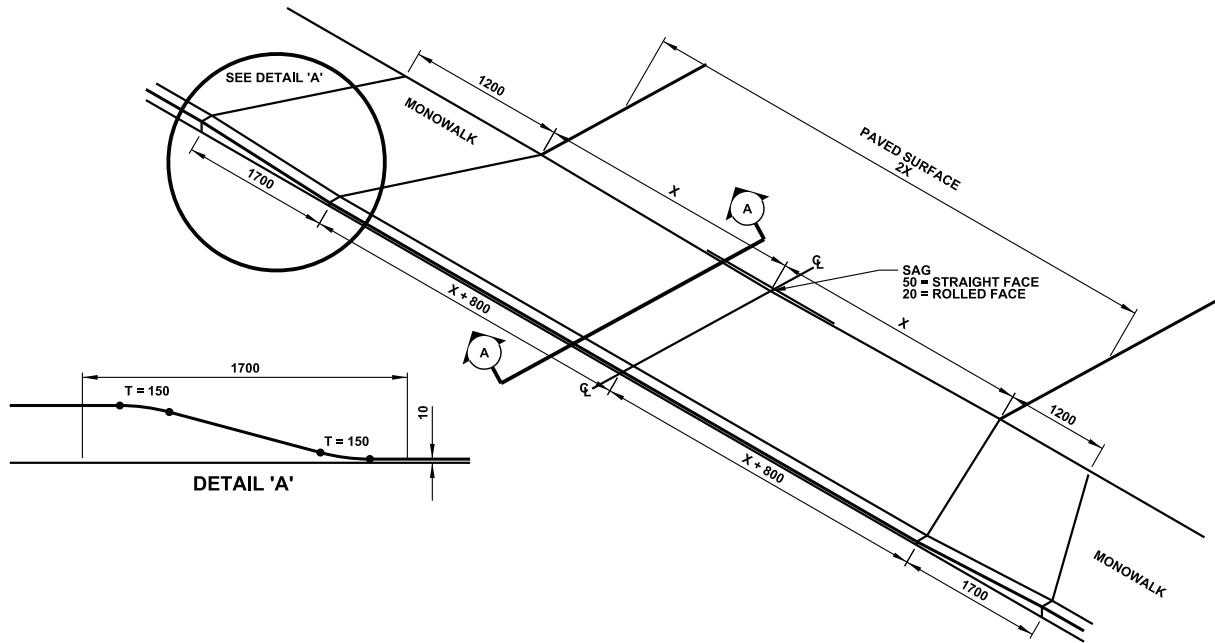

SECTION A-A STRAIGHT FACE

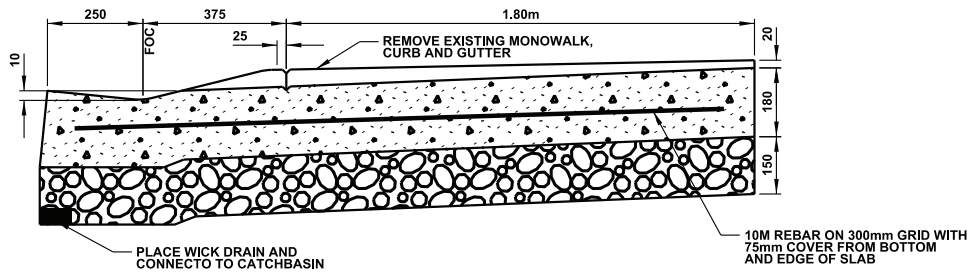

SECTION A-A ROLLED FACE

NOTES:

1. MAXIMUM CROSSFALL SLOPE TO BE 8.00% UNLESS OTHERWISE APPROVED BY ENGINEER.
2. CROSSING MUST BE POURED MONOLITHICALLY WITH CURB AND GUTTER
3. BACK OF CROSSING DROP FOR EXISTING 200mm CURB FACE TO BE 50mm.

**ALL DIMENSIONS  
IN MILLIMETRES UNLESS  
OTHERWISE NOTED**



STANDARD DRAWING

## ALLEY CROSSING MONOWALK AND APRONS

DATE APPROVED: **2018**  
SCALE: **N.T.S.**

DRAWN BY: **KSYC**  
CHECKED BY: **JN**

APPROVED: *M.A.R.*

DRAWING NUMBER: **5310**

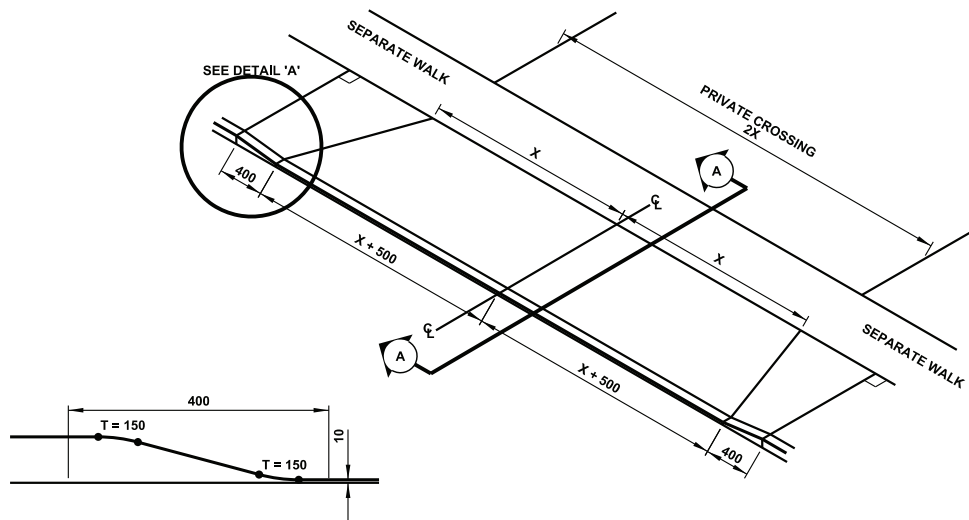

DETAIL 'A'

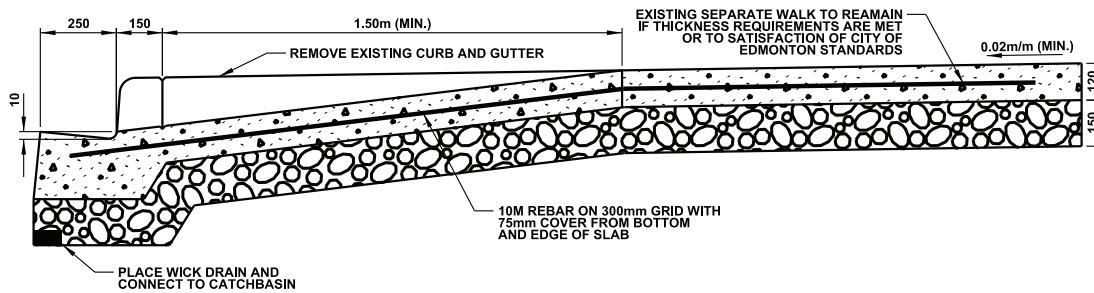

SECTION A-A STRAIGHT FACE

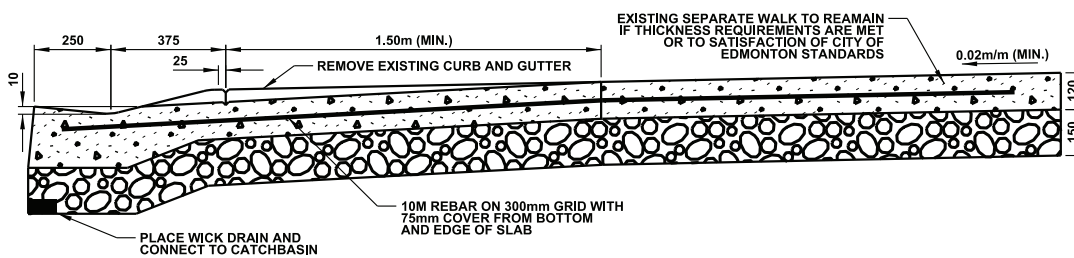

SECTION A-A ROLLED FACE

NOTES:

1. MAXIMUM CROSSFALL SLOPE TO BE 8.00% UNLESS OTHERWISE APPROVED BY ENGINEER.
2. CROSSING MUST BE POURED MONOLITHICALLY WITH CURB AND GUTTER.

**ALL DIMENSIONS  
IN MILLIMETRES UNLESS  
OTHERWISE NOTED**

**PRIVATE CROSSING  
SEPARATE WALK AND APRONS**



STANDARD DRAWING

2023-08-31

DATE APPROVED: **2018**

SCALE: **N.T.S.**

DRAWN BY: **KSYC**

CHECKED BY: **JN**

APPROVED: *M.A.R.*

DRAWING NUMBER:

**5320**

v05

Page 627

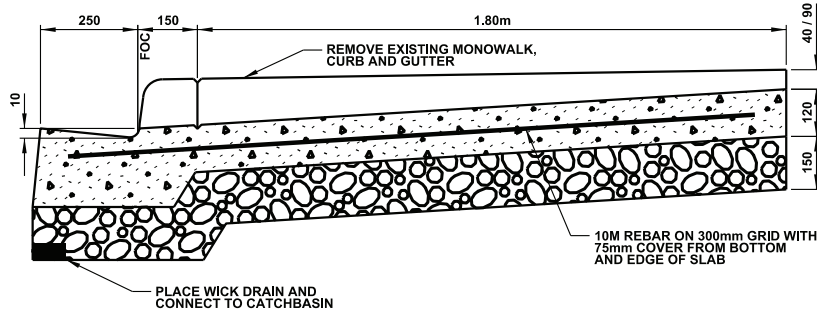
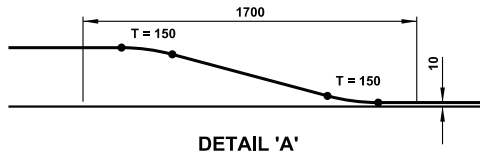
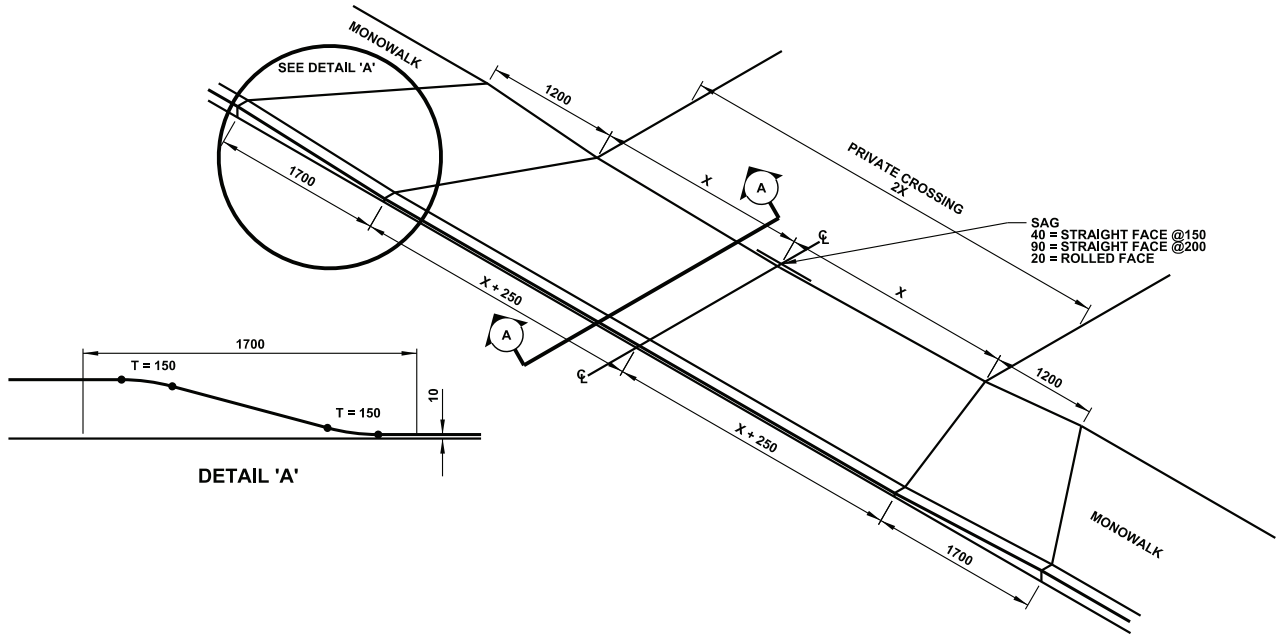

SECTION A-A STRAIGHT FACE

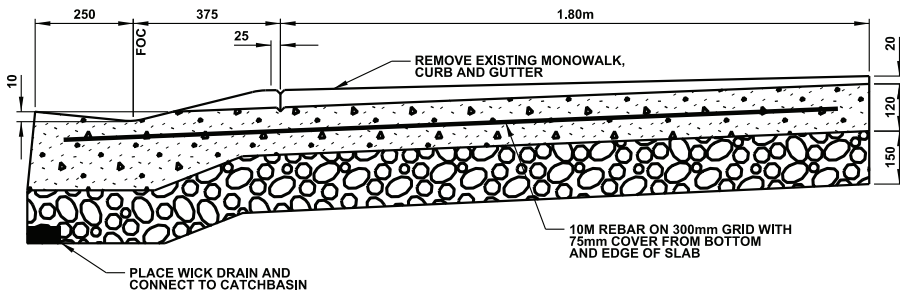

SECTION A-A ROLLED FACE

NOTES:

1. MAXIMUM CROSSFALL SLOPE TO BE 8.00% UNLESS OTHERWISE APPROVED BY ENGINEER.
2. CROSSING MUST BE POURED MONOLITHICALLY WITH CURB AND GUTTER.
3. BACK OF CROSSING DRIOP FOR EXISTING 200mm CURBFACE TO BE 50mm.

**ALL DIMENSIONS  
IN MILLIMETRES UNLESS  
OTHERWISE NOTED**



STANDARD DRAWING

**PRIVATE CROSSING  
MONOWALK AND APRONS**

DATE APPROVED: **2018**  
SCALE: **N.T.S.**

DRAWN BY: **KSYC**  
CHECKED BY: **JN**

APPROVED: *M.A.R.*

DRAWING NUMBER: **5330**

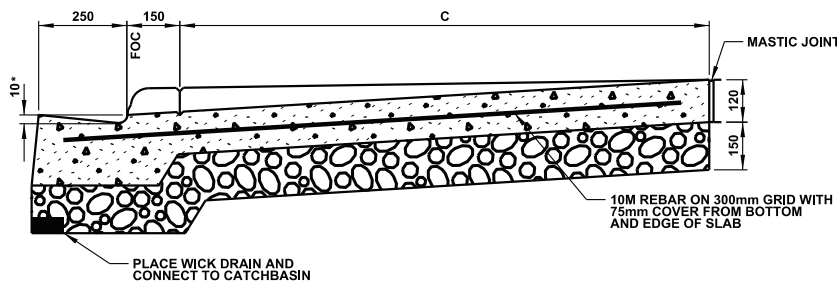
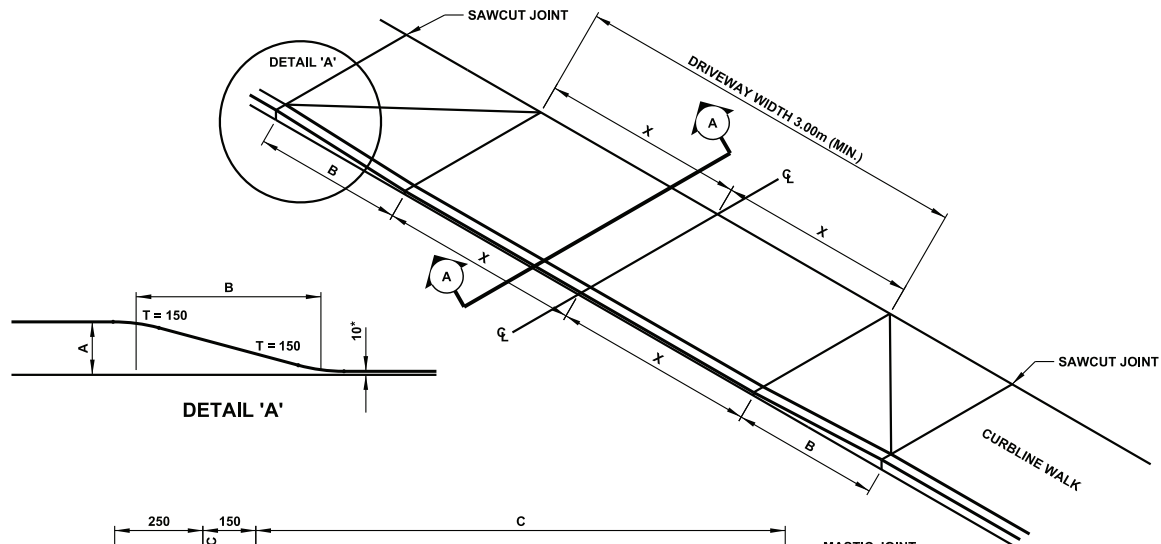

SECTION A-A STRAIGHT FACE

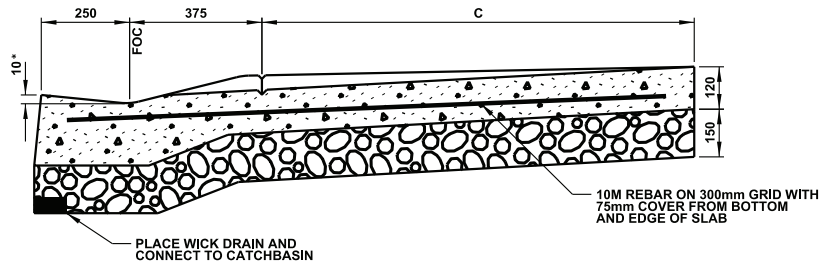

SECTION A-A ROLLED FACE

CURB HEIGHT	125	150	200	215	A
ROLLED UP	1250	1500	2200	2700	B
FOC - BOW	1250	1500	2200	2700	C

NOTES:

1. MAXIMUM CROSSFALL SLOPE TO BE 8.00% UNLESS OTHERWISE APPROVED BY ENGINEER.
2. CROSSING MUST BE POURED MONOLITHICALLY WITH CURB AND GUTTER.
3. (\*) IF THE STANDARD LIP HEIGHT OF 10mm CREATES EXCESSIVE X-FALL ON THE CROSSING THE LIP HEIGHT MAY BE MODIFIED TO A MAXIMUM OF 25mm.

**ALL DIMENSIONS  
IN MILLIMETRES UNLESS  
OTHERWISE NOTED**

**PRIVATE CROSSING  
MONOWALK (RETROFIT)**



STANDARD DRAWING

DATE APPROVED: **2018**

DRAWN BY: **KSYC**

APPROVED: *M.A.R.*

DRAWING NUMBER: **5340**

SCALE: **N.T.S.**

CHECKED BY: **JN**

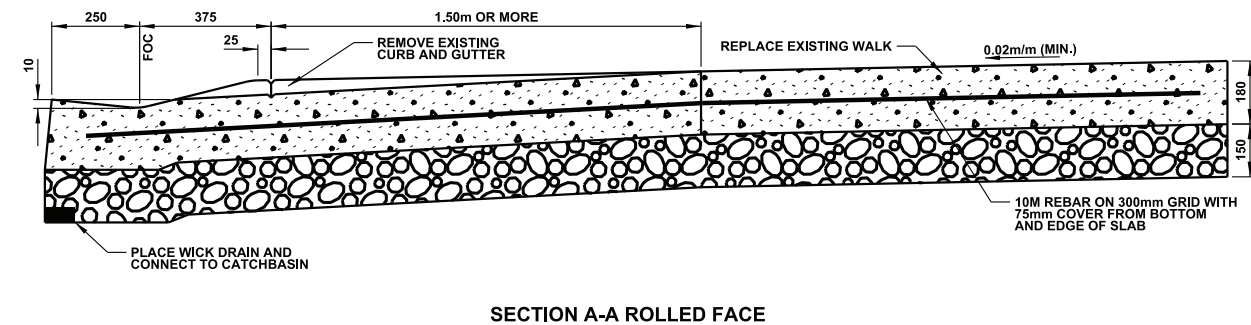
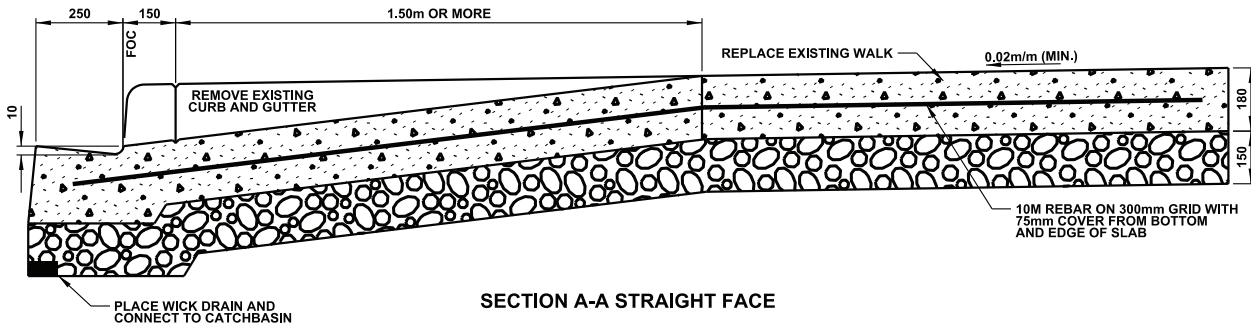
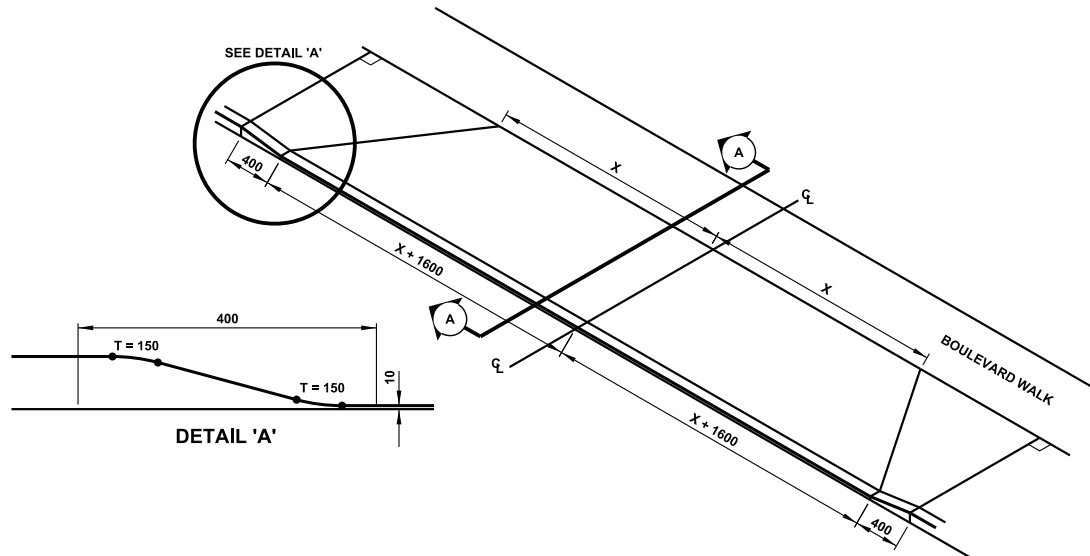

NOTES:

1. MAXIMUM CROSSFALL SLOPE TO BE 8.00% UNLESS APPROVED BY ENGINEER.
2. CROSSING MUST BE POURED MONOLITHICALLY WITH CURB AND GUTTER.

**ALL DIMENSIONS  
IN METRES UNLESS  
OTHERWISE NOTED**



STANDARD DRAWING

**COMMERCIAL CROSSING  
BOULEVARD WALK AND APRONS  
(BOULEVARD > 1.50m)**

DATE APPROVED: **2018**  
SCALE: **N.T.S.**

DRAWN BY: **KSYC**  
CHECKED BY: **JN**

APPROVED: *M.A.R.*

DRAWING NUMBER:  
**5400**

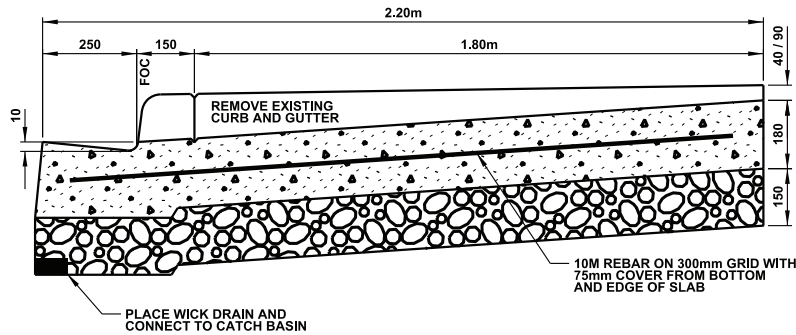
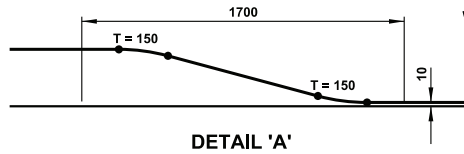
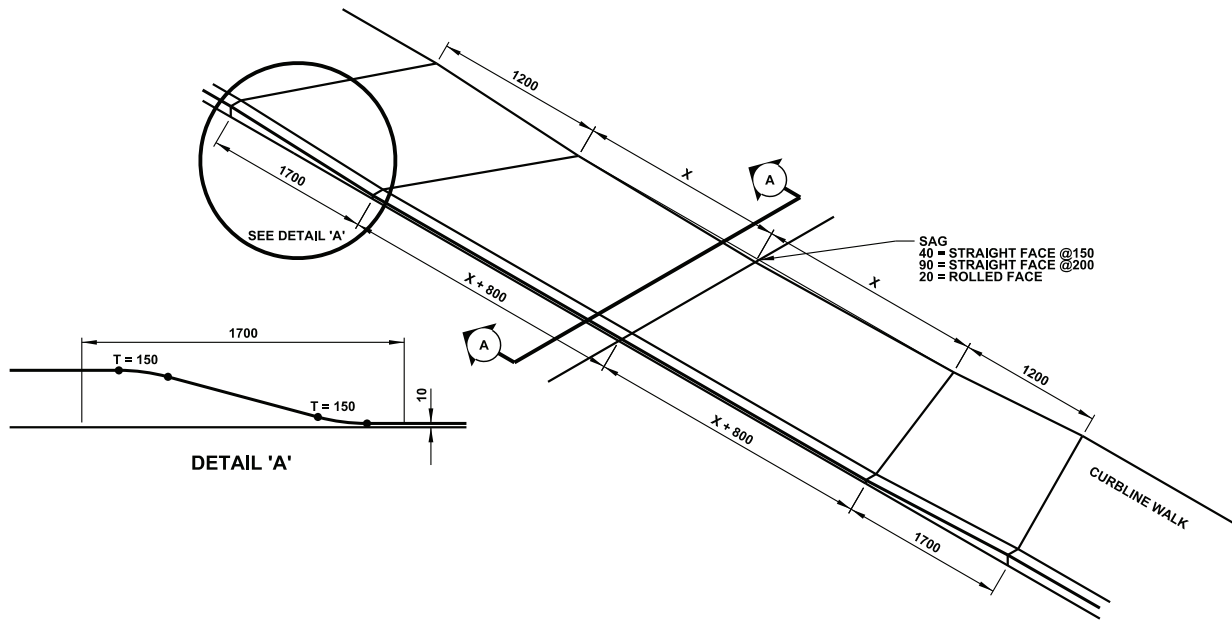

SECTION A-A STRAIGHT FACE

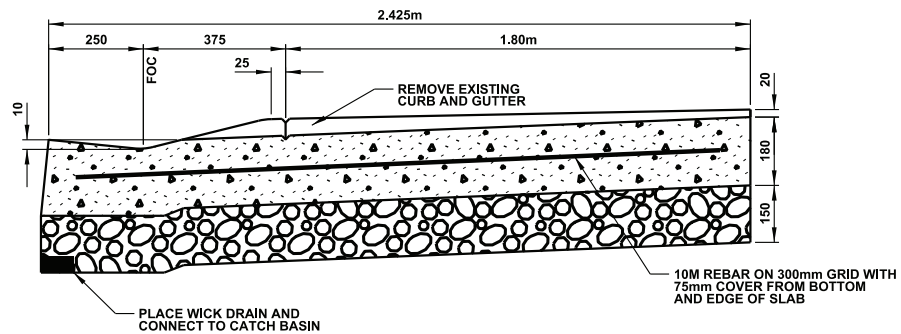

SECTION A-A ROLLED FACE

NOTES:

1. MAXIMUM CROSSFALL SLOPE TO BE 8.00% UNLESS APPROVED BY ENGINEER.
2. CROSSING MUST BE POURED MONOLITHICALLY WITH CURB AND GUTTER.

**ALL DIMENSIONS  
IN MILLIMETRES UNLESS  
OTHERWISE NOTED**

STANDARD DRAWING

**COMMERCIAL CROSSING  
MONOWALK AND BOULEVARD WALK  
(BOULEVARD < 1.50m)**

DATE APPROVED: **2018**

SCALE: **N.T.S.**

DRAWN BY: **KSYC**

CHECKED BY: **JN**

APPROVED: *M.A.R.*

DRAWING NUMBER: **5410**

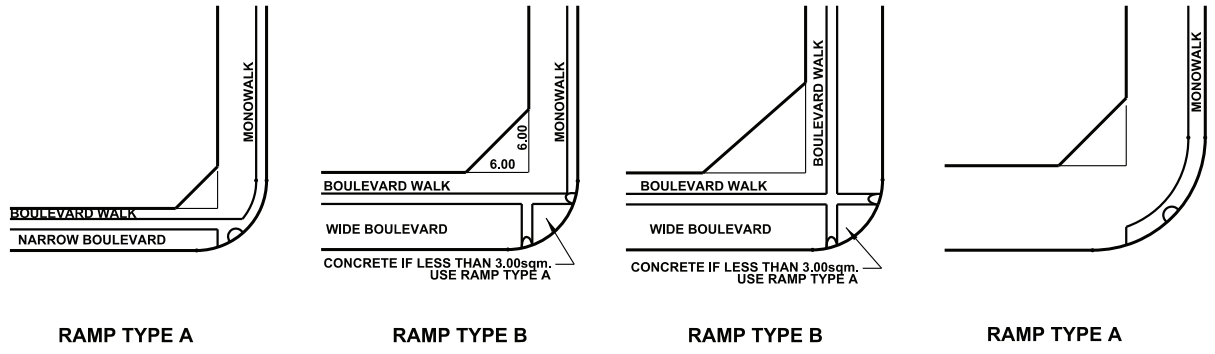

CORNER LAYOUT

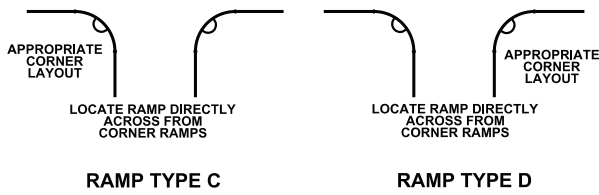
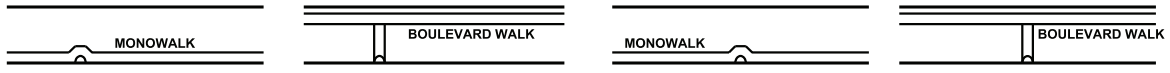

TANGENT LAYOUT

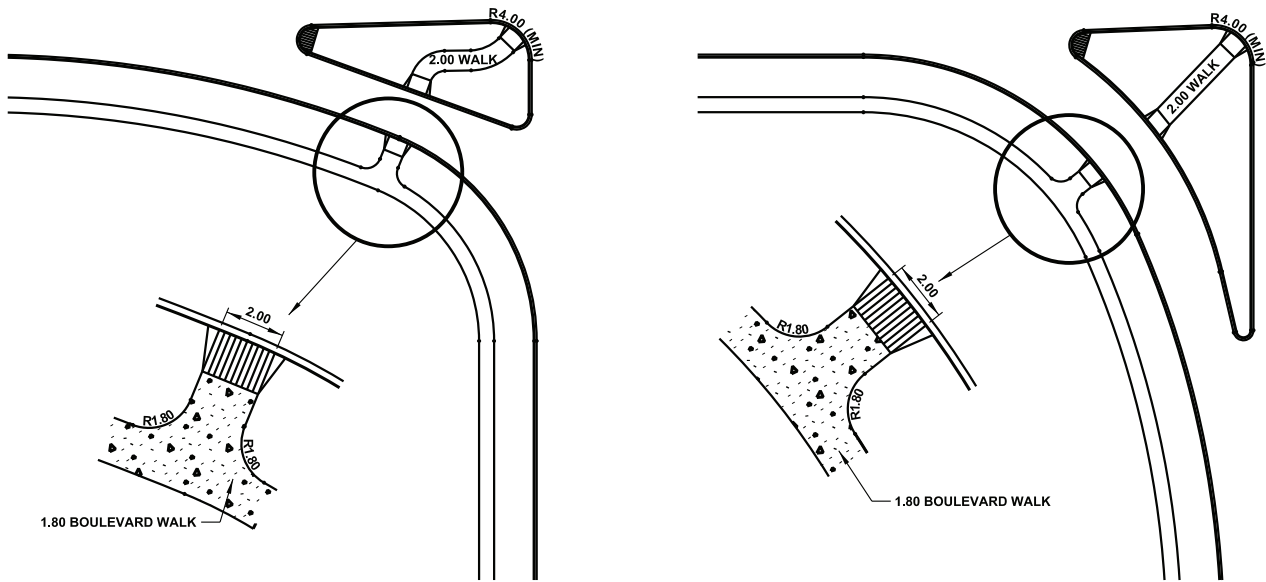

NOTE:

- SEE DRAWING #5510 FOR RAMP TYPES
- ARTERIAL - ARTERIAL INTERSECTION:
  - 1.80 BOULEVARD WALK BECOMES 3.00 SHARED-USE PATH
  - 2.00 CURB RAMP PAN BECOMES 3.00 CURB RAMP PAN

ALL DIMENSIONS  
IN METRES UNLESS  
OTHERWISE NOTED

CURB RAMP LOCATIONS



STANDARD DRAWING

DATE APPROVED: 2018

DRAWN BY: KSYC

APPROVED: *M.A.R.*

DRAWING NUMBER: 5500

SCALE: N.T.S.

CHECKED BY: JN



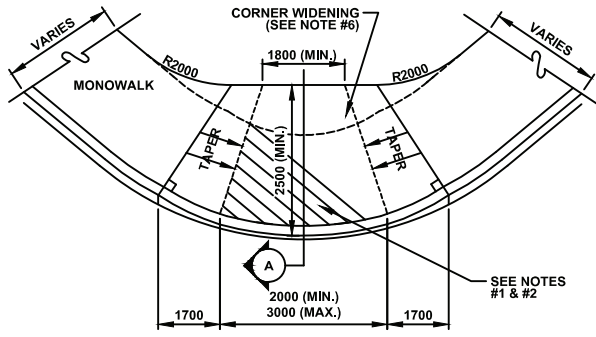

TYPE A1 (ONE DIRECTION)

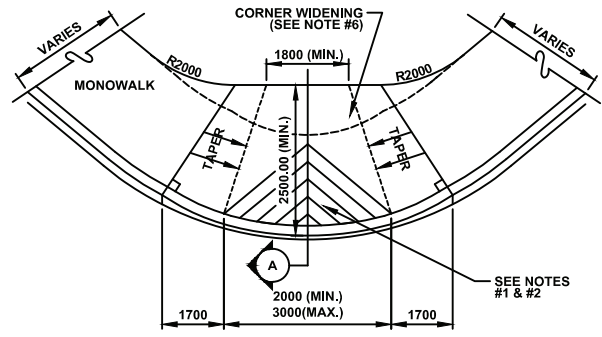

TYPE A2 (TWO DIRECTIONS)

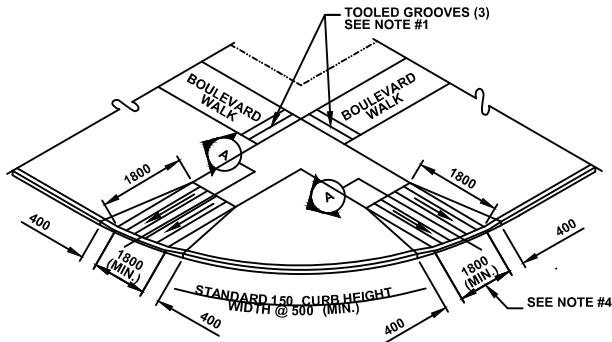

TYPE B

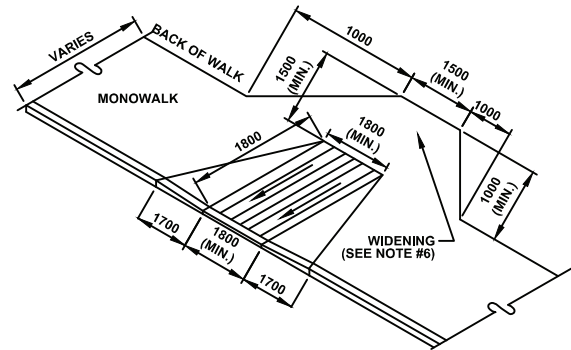

TYPE C

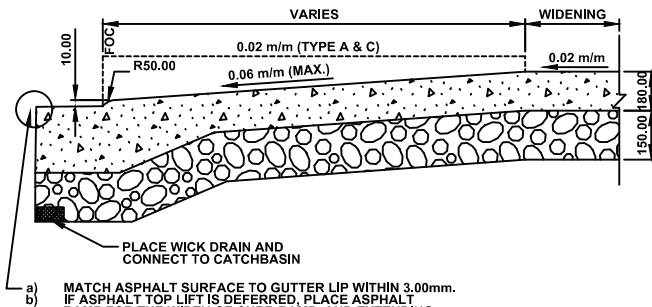

TYPICAL CROSS SECTION A-A

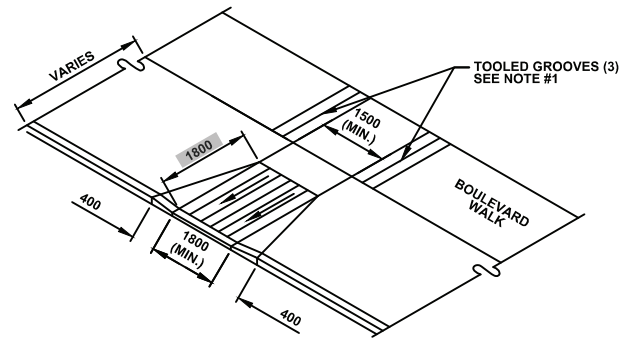

TYPE D

NOTES:

1. TOOLED GROOVES 5.00mm WIDE x 10.00mm DEEP, BROOM FINISHED. GROOVE SPACING 150.00mm o.c. ADJACENT TO CURB.
2. GROOVES TO BE IN DIRECTION OF TRAVEL.
3. WHEN REQUIRED, TRANSITION FROM STRAIGHT FACE CURB TO ROLLED FACE CURB AT CURB RAMP.
4. CURBS AND RAMPS TO BE POURED MONOLITHICALLY.
5. WIDTH OF RAMP MUST EQUAL WIDTH OF WALK (1.80m MIN., 3.00m MAX.) EXCEPT "TYPE A".
6. PROVIDE 1.00m WIDENING (AT 2.00% MIN. X-FALL) FROM BACK OF CURB RAMP (TYPES A & C) WHERE ROAD RIGHT-OF-WAY ALLOWS.
7. 1500mm x 1500mm LEVEL SURFACE SHALL BE MAINTAINED ON THE SIDEWALK BEHIND CURB RAMPS.
8. FOR BOULEVARD WALK TO CURBLINE WALK, REFER TO DRAWING #5500 FOR CURB RAMP LOCATIONS AND TYPES.

**ALL DIMENSIONS  
IN METRES UNLESS  
OTHERWISE NOTED**



## CURB RAMP

DATE APPROVED: <b>2018</b>	DRAWN BY: <b>KSYC</b>	APPROVED: <i>M.A.R.</i>	DRAWING NUMBER: <b>5510</b>
SCALE: <b>N.T.S.</b>	CHECKED BY: <b>JN</b>		

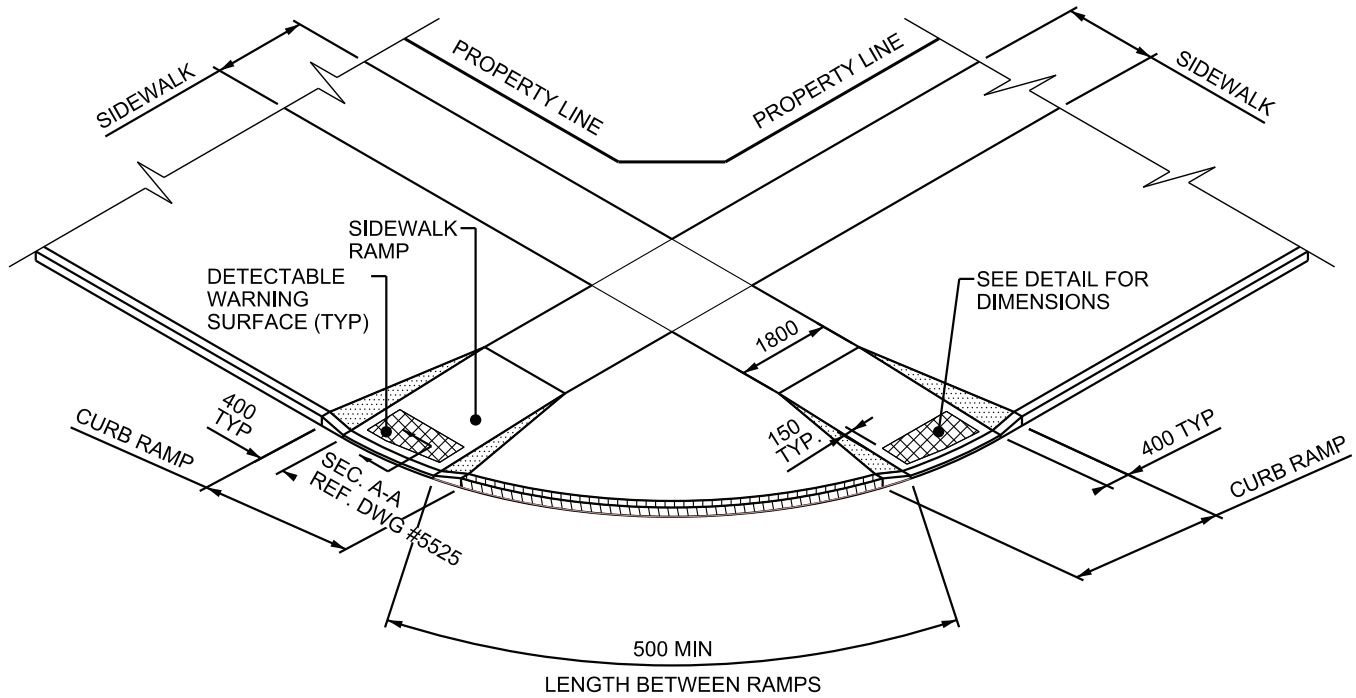

STANDARD LAYOUT

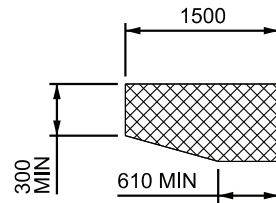

DETECTABLE WARNING SURFACE DETAIL

**ALL DIMENSIONS  
IN MILLIMETRES UNLESS  
OTHERWISE NOTED**

**TACTILE WALKING SURFACE INDICATOR (TWSI)  
LAYOUT FOR SEPARATE WALK**



STANDARD DRAWING

2023-08-31

DATE APPROVED: **2018**

SCALE: **N.T.S.**

DRAWN BY: **KSYC**

CHECKED BY: **JN**

APPROVED: *MAR*

DRAWING NUMBER: **5520**

v05

Page 634

NOTE:

ON THE STREETSIDE OF DETECTABLE WARNING SURFACE TILES, CROSS PATHS OF TRAVEL ARE NOT ALLOWED

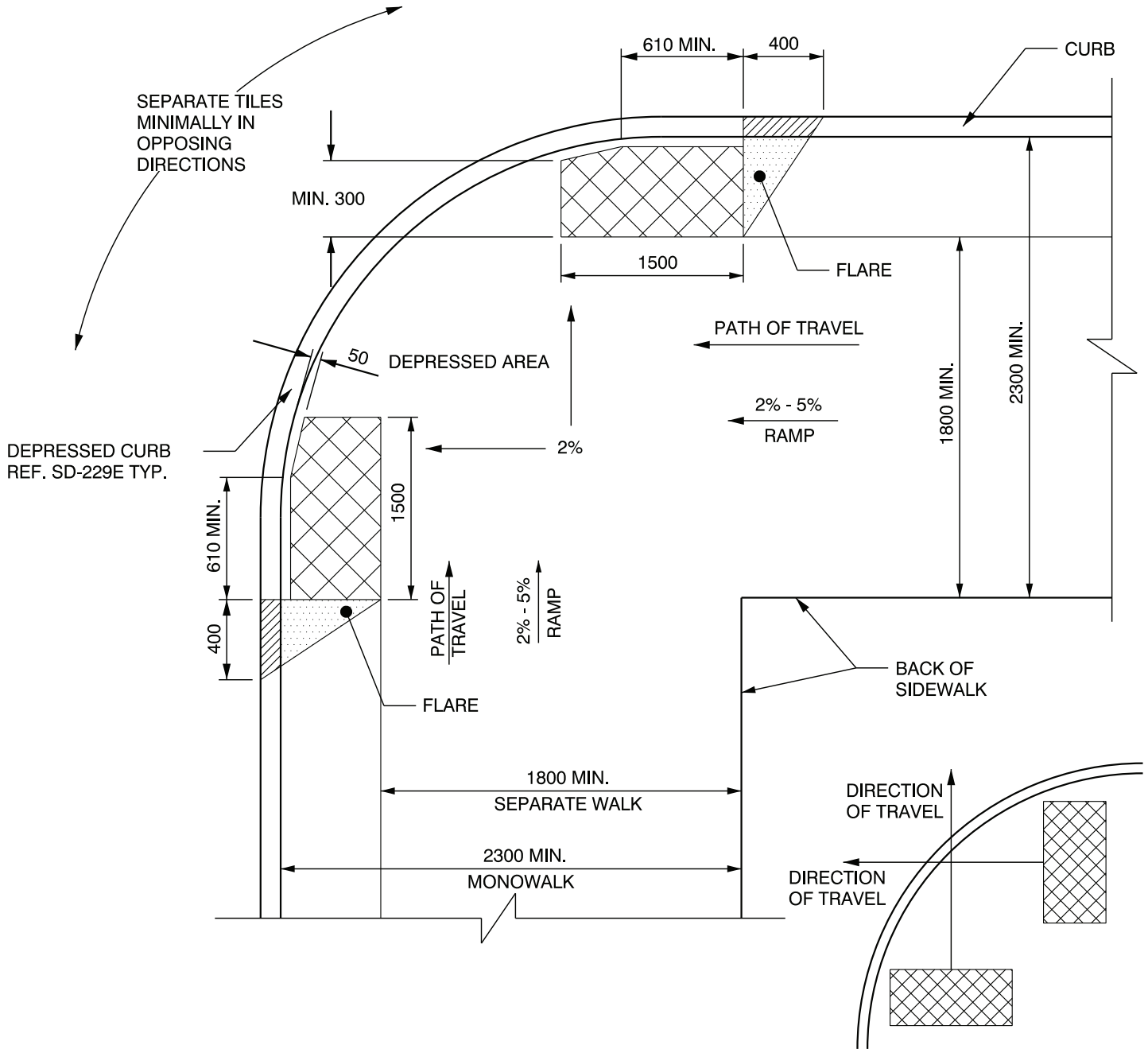

**NOT ALLOWED**

**ALL DIMENSIONS IN MILLIMETRES UNLESS OTHERWISE NOTED**

**TACTILE WARNING SURFACE INDICATOR (TWSI) LAYOUT FOR WALK**



STANDARD DRAWING

2023-08-31

DATE APPROVED:

2018

DRAWN BY:

KSYC

APPROVED:

DRAWING NUMBER:

5521

SCALE:

N.T.S.

CHECKED BY:

JN

v05

Page 635

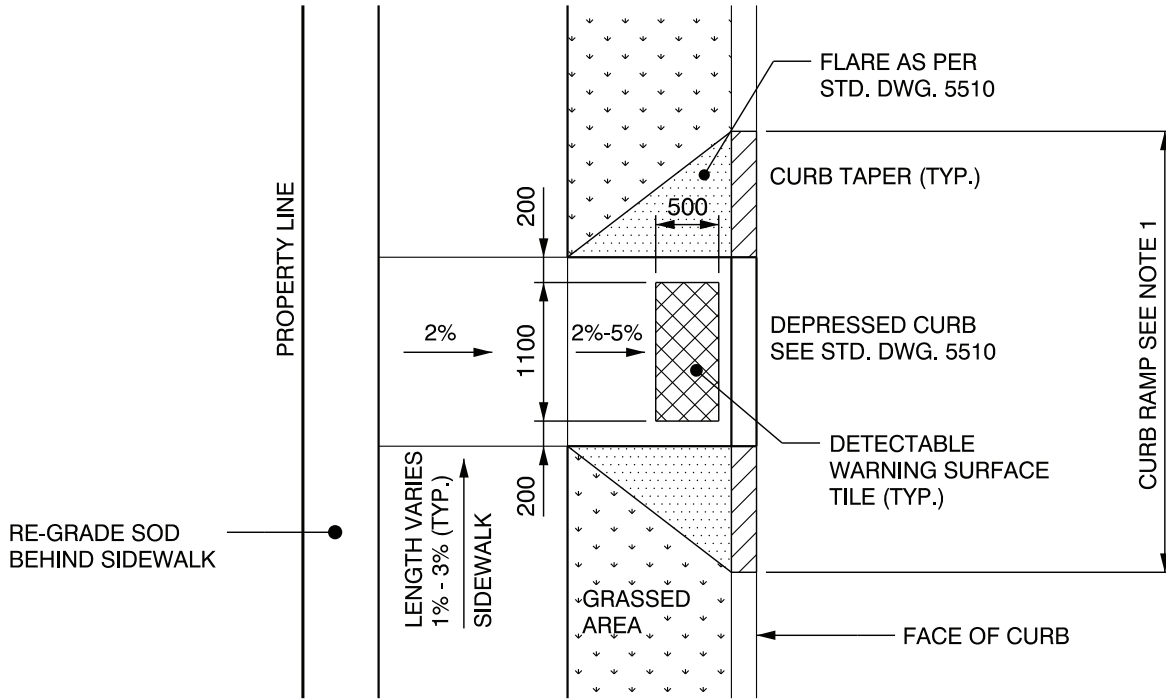

**SEPARATED SIDEWALK**

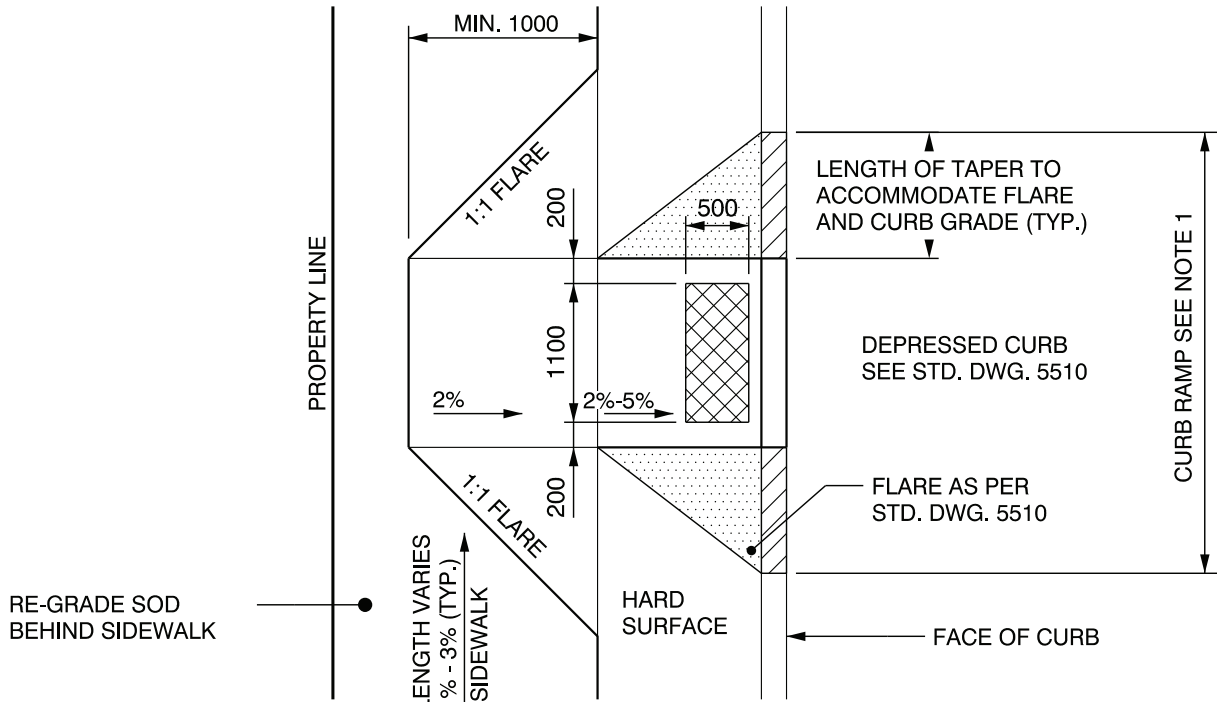

**MONOLITHIC SIDEWALK**

NOTE:

1. FULL DEPTH SAWCUT REQUIRED THROUGH THE STREET SLAB ALONG CURB RAMP. SEE STD. DWG. 5510

**ALL DIMENSIONS IN MILLIMETRES UNLESS OTHERWISE NOTED**

**TACTILE WALKING SURFACE INDICATOR (TWSI) LAYOUT FOR MID-BLOCK CROSSING**



STANDARD DRAWING

DATE APPROVED:

2018

DRAWN BY:

KSYC

APPROVED:

*MAR*

DRAWING NUMBER:

5522

SCALE:

N.T.S.

CHECKED BY:

JN

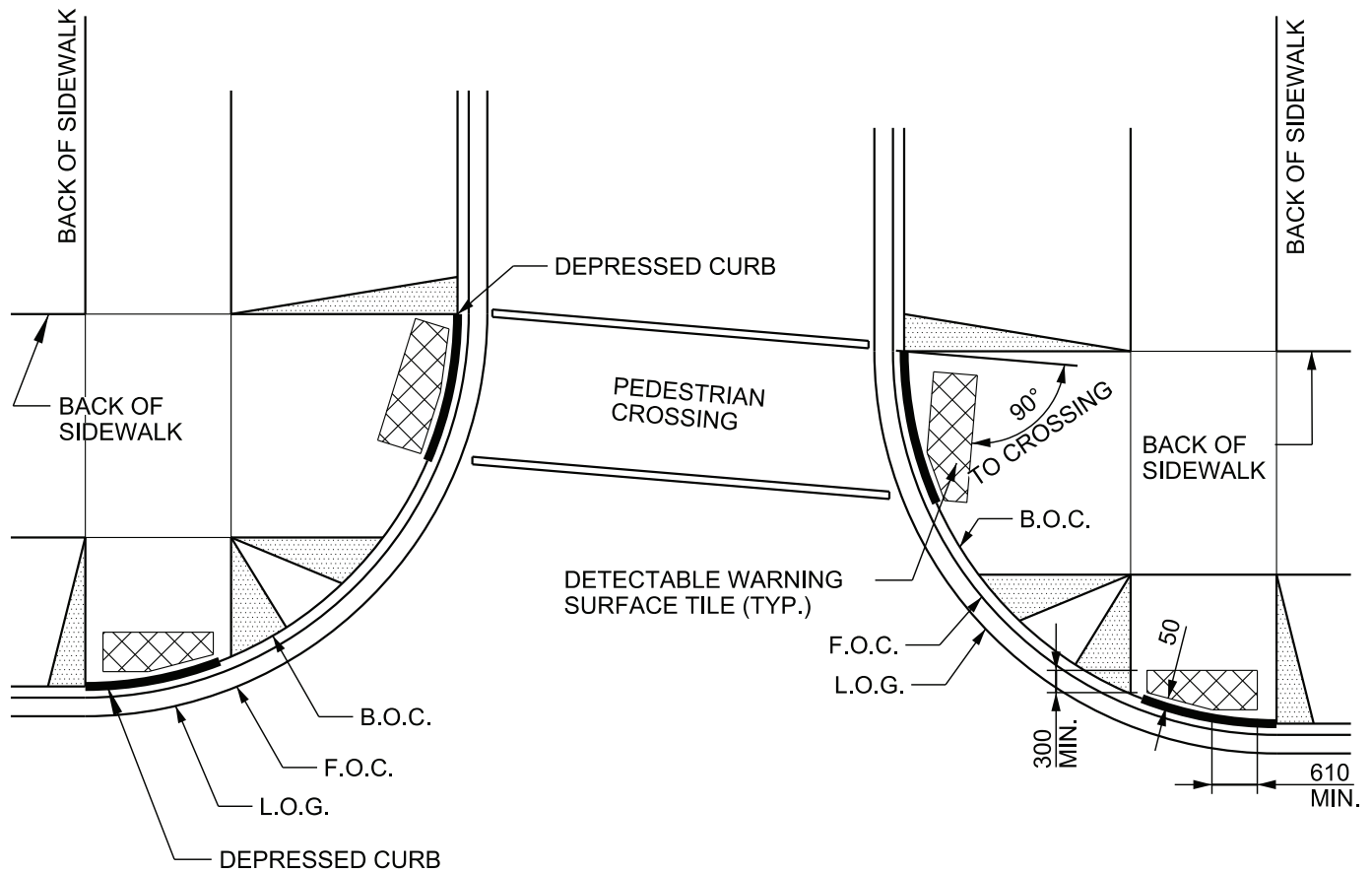

NOTE:

1. LOCATE END OF DEPRESSED CURB IN LINE WITH PROJECTED BACK OF SIDEWALK.

**ALL DIMENSIONS  
IN MILLIMETRES UNLESS  
OTHERWISE NOTED**



STANDARD DRAWING

2023-08-31

**TACTILE WALKING SURFACE INDICATOR (TWSI)  
ORIENTATION FOR OFFSET INTERSECTIONS**

DATE APPROVED:

2018

DRAWN BY:

KSYC

APPROVED:

*MAR*

DRAWING NUMBER:

5523

SCALE:

N.T.S.

CHECKED BY:

JN

v05

Page 637

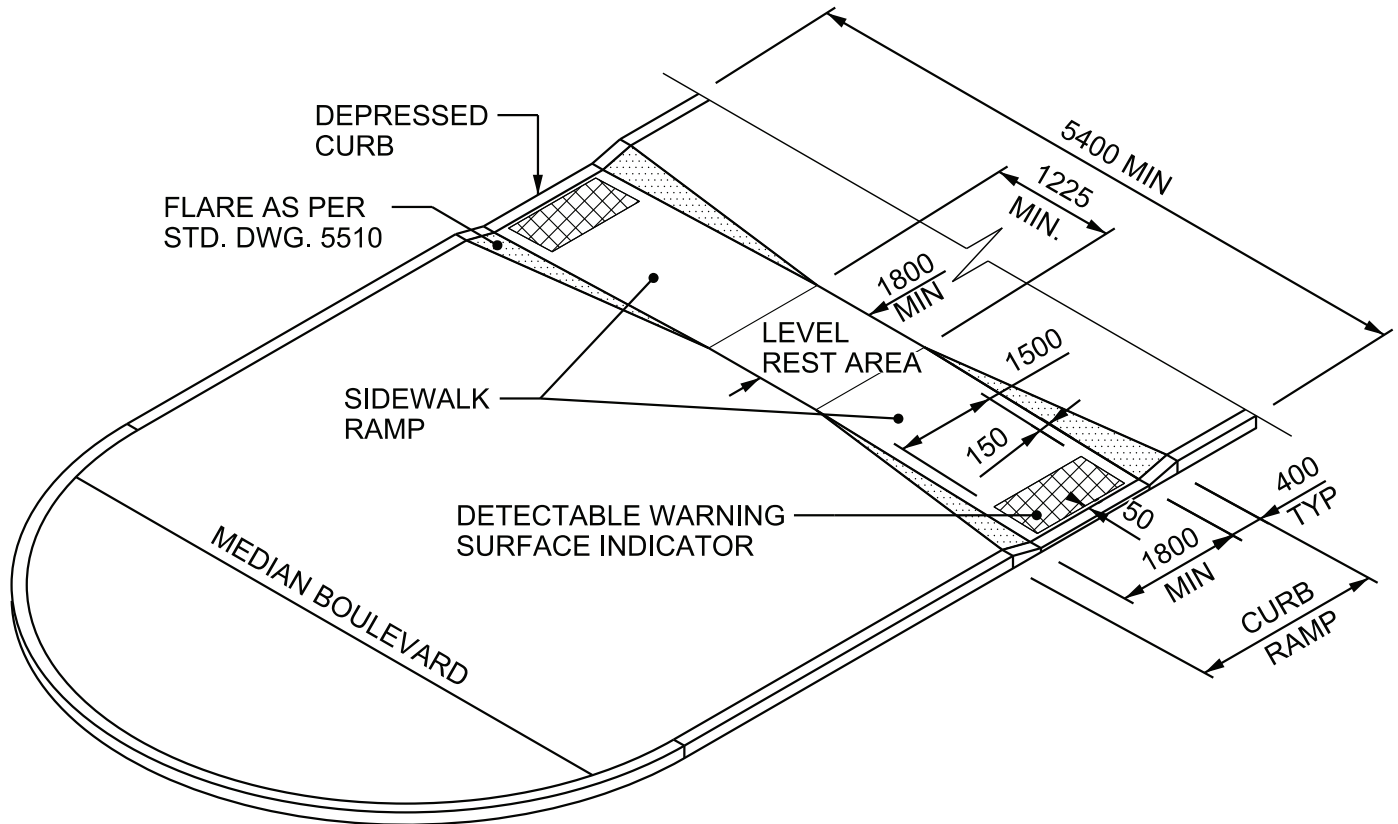

**MEDIAN SIDEWALK CROSSING**

**ALL DIMENSIONS  
IN MILLIMETRES UNLESS  
OTHERWISE NOTED**



STANDARD DRAWING

2023-08-31

**TACTILE WALKING SURFACE INDICATOR (TWSI)  
MEDIAN DETAIL**

DATE APPROVED: **2018**

DRAWN BY: **KSYC**

APPROVED: *M.R.*

DRAWING NUMBER: **5524**

SCALE: **N.T.S.**

CHECKED BY: **JN**

V05

Page 638

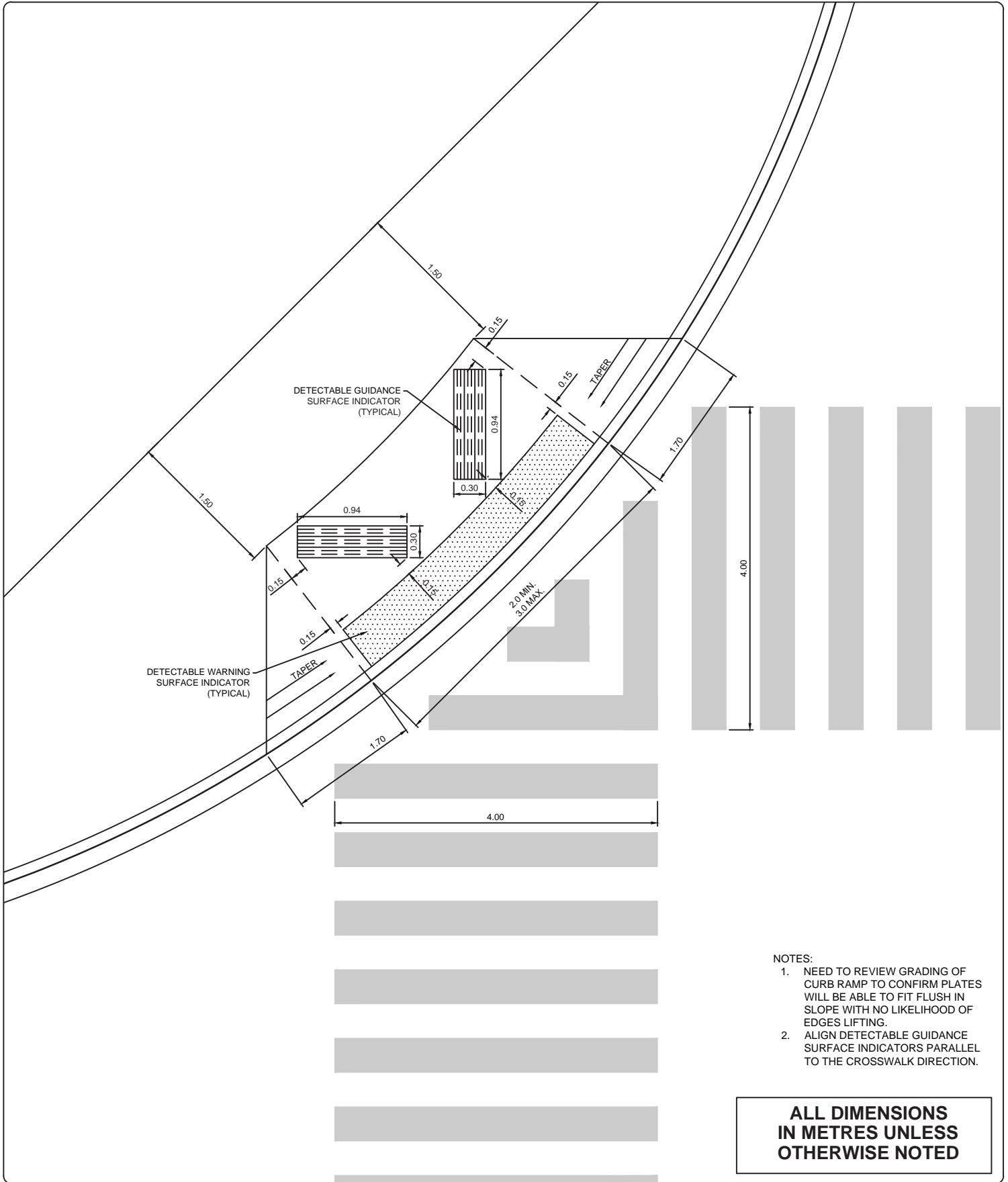

- NOTES:
1. NEED TO REVIEW GRADING OF CURB RAMP TO CONFIRM PLATES WILL BE ABLE TO FIT FLUSH IN SLOPE WITH NO LIKELIHOOD OF EDGES LIFTING.
  2. ALIGN DETECTABLE GUIDANCE SURFACE INDICATORS PARALLEL TO THE CROSSWALK DIRECTION.

**ALL DIMENSIONS IN METRES UNLESS OTHERWISE NOTED**

STANDARD DRAWING

**TYPE A RAMP  
TWSI OPTION 1**

DATE APPROVED: **2023**  
 SCALE: **N.T.S.**

DRAWN BY: **R.F.**  
 CHECKED BY: **MW**

APPROVED: *Matthew Ivany*  
 AB984D7343E14A9...

DRAWING NUMBER: **5530**

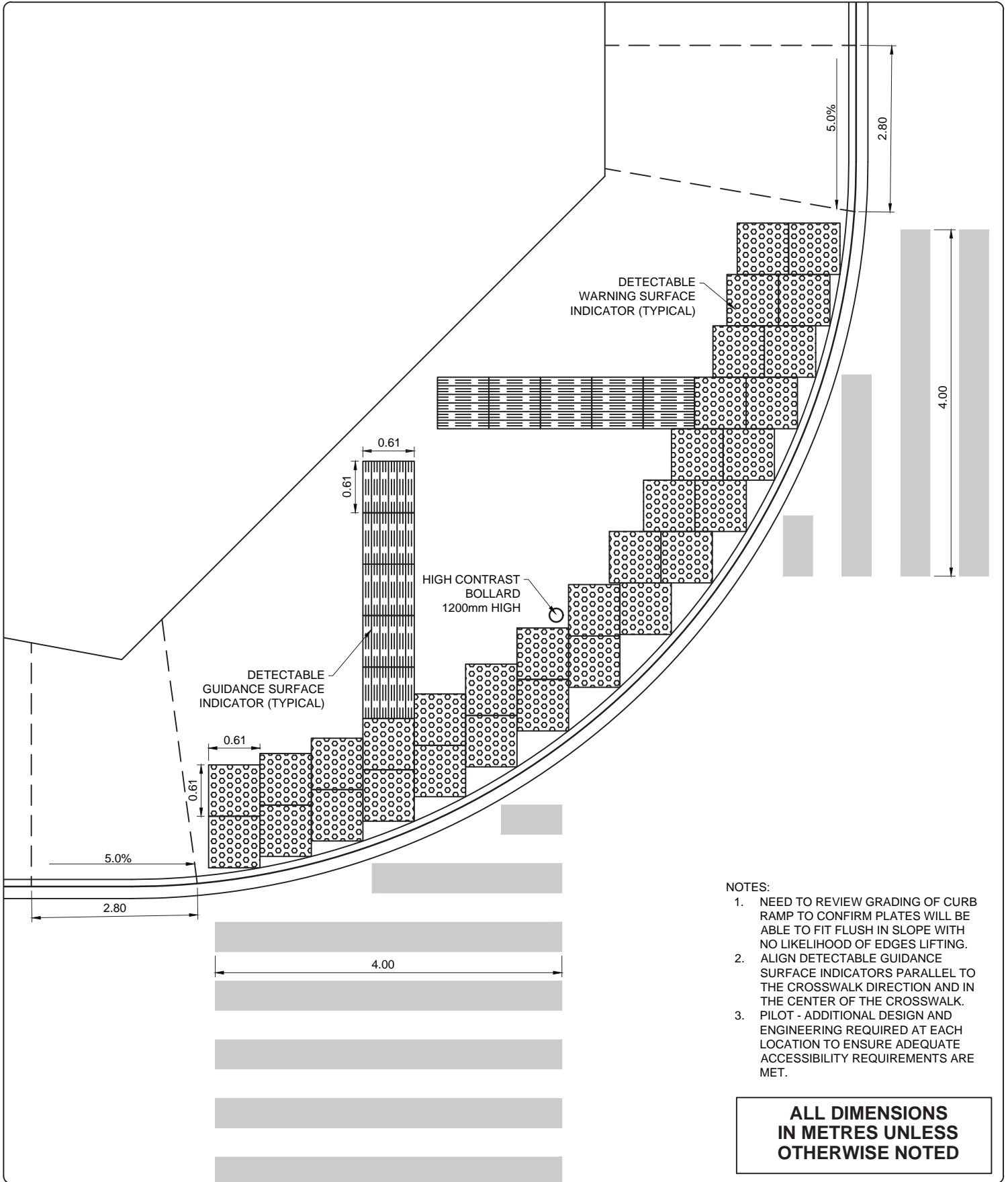

**NOTES:**

1. NEED TO REVIEW GRADING OF CURB RAMP TO CONFIRM PLATES WILL BE ABLE TO FIT FLUSH IN SLOPE WITH NO LIKELIHOOD OF EDGES LIFTING.
2. ALIGN DETECTABLE GUIDANCE SURFACE INDICATORS PARALLEL TO THE CROSSWALK DIRECTION AND IN THE CENTER OF THE CROSSWALK.
3. PILOT - ADDITIONAL DESIGN AND ENGINEERING REQUIRED AT EACH LOCATION TO ENSURE ADEQUATE ACCESSIBILITY REQUIREMENTS ARE MET.

**ALL DIMENSIONS IN METRES UNLESS OTHERWISE NOTED**

**Edmonton**  
STANDARD DRAWING

**TYPE A RAMP  
TWSI OPTION 2**

DATE APPROVED: **2023**  
SCALE: **N.T.S.**

DRAWN BY: **R.F.**  
CHECKED BY: **MW**

APPROVED: *Matthew Ivany*  
DocuSigned by: *Matthew Ivany*  
AB984D7343E14A9...

DRAWING NUMBER: **5531**



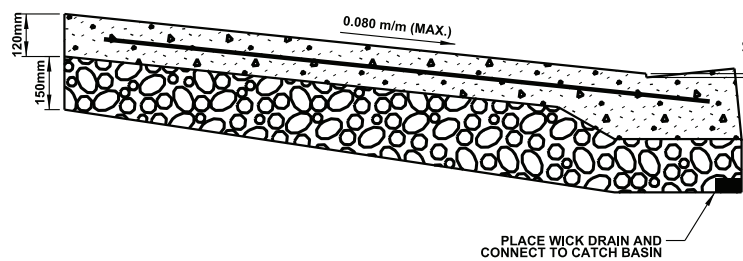
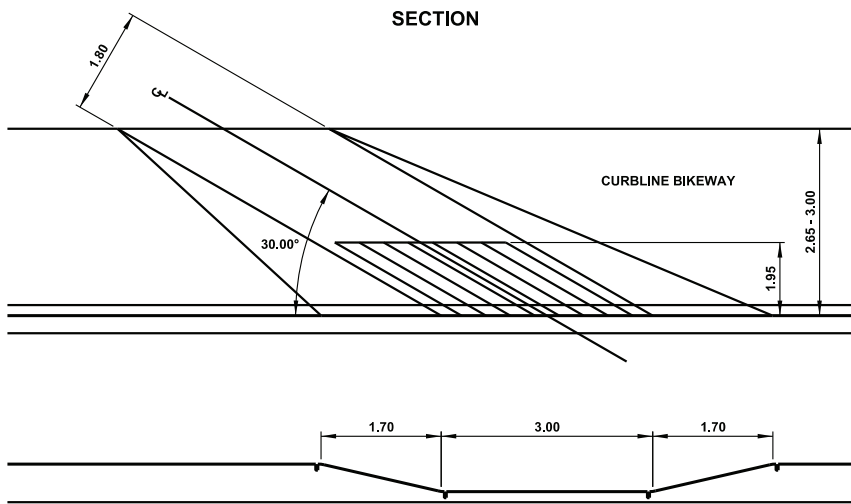
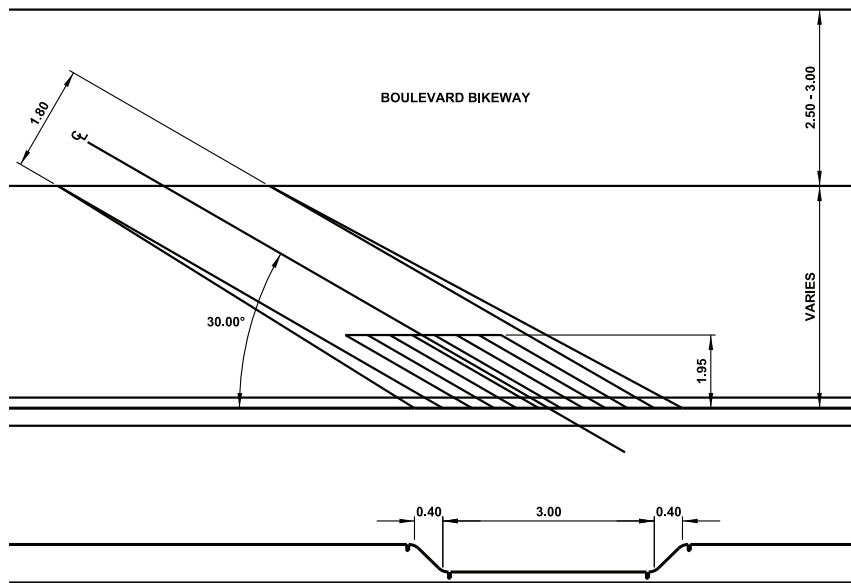

**NOTES:**

1. REPLACE CURBLINE BIKEWAY TO NEAREST JOINTS.
2. CURB AND RAMP TO BE POURED MONOLITHICALLY.
3. BROOMED FINISH. TOOLED GROOVES 5mm WIDE x 10mm DEEP, SPACED 150mm o.c.

**ALL DIMENSIONS  
IN METRES UNLESS  
OTHERWISE NOTED**



**STANDARD DRAWING**

### MID-BLOCK BIKEWAY SLIP RAMP

DATE APPROVED: **2018**

DRAWN BY: **KSYC**

APPROVED: *M.A.R.*

DRAWING NUMBER: **5600**

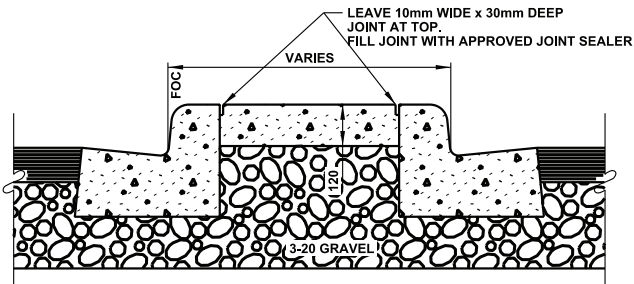
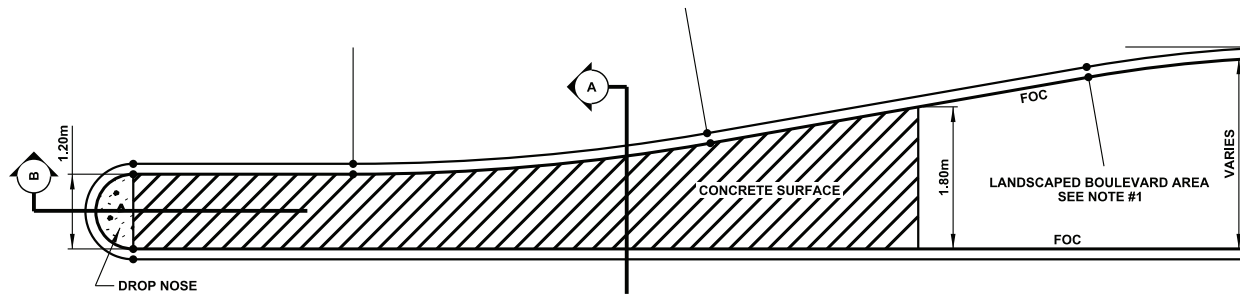

SECTION A-A

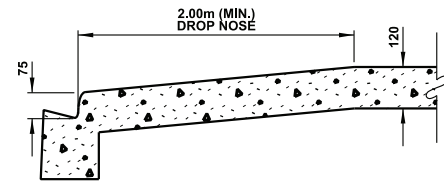

SECTION B-B

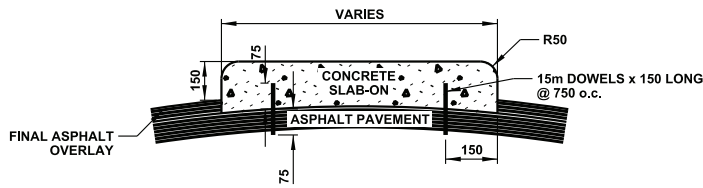

SECTION A-A

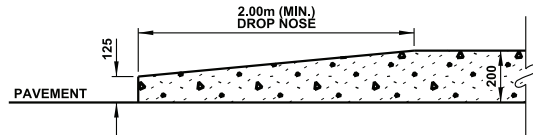

SECTION B-B

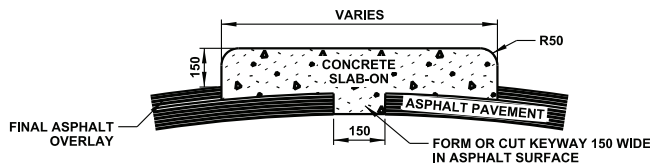

SECTION A-A

NOTE:

1. CONCRETE HEADER WITH CURB AND GUTTER IS REQUIRED WITHIN MEDIAN LANDSCAPED BOULEVARD AREA.

**ALL DIMENSIONS  
IN MILLIMETRES UNLESS  
OTHERWISE NOTED**



STANDARD DRAWING

2023-08-31

**CENTRE MEDIAN  
END TREATMENT**

DATE APPROVED: **2018**

SCALE: **N.T.S.**

DRAWN BY: **KSYC**

CHECKED BY: **JN**

APPROVED: *M.L.R.*

DRAWING NUMBER:

**5610**

v05

Page 642

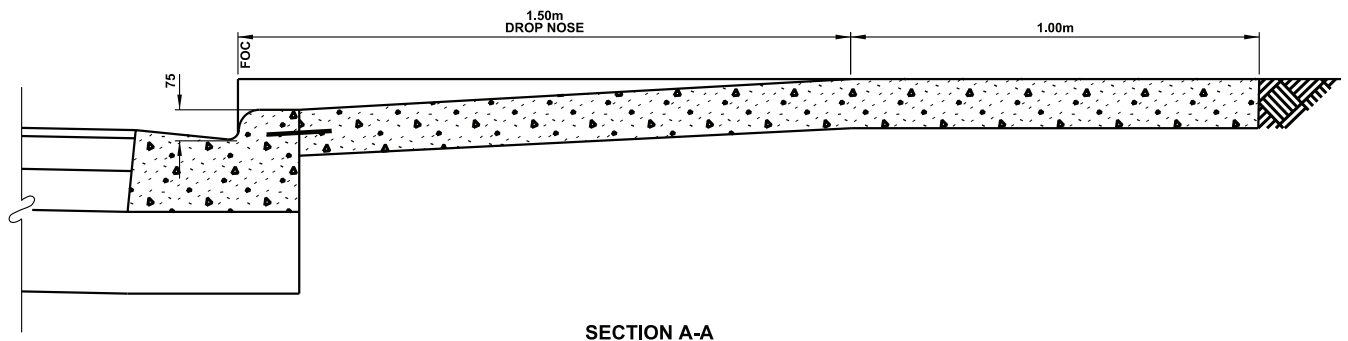
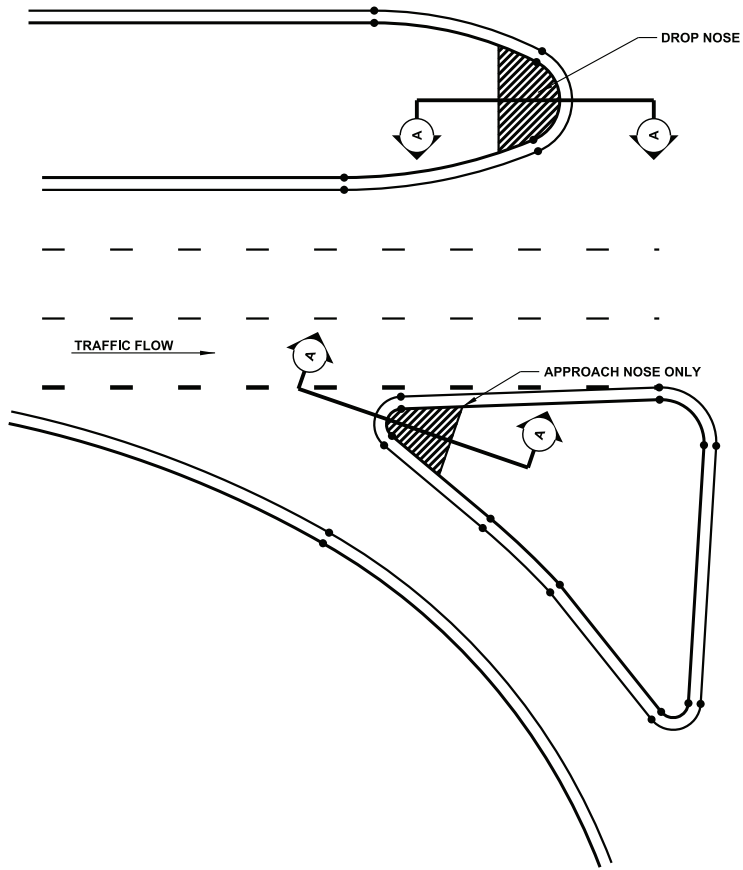

**ALL DIMENSIONS  
IN MILLIMETRES UNLESS  
OTHERWISE NOTED**

**WIDE MEDIAN  
END TREATMENT**



STANDARD DRAWING

2023-08-31

DATE APPROVED: **2018**

SCALE: **N.T.S.**

DRAWN BY: **KSYC**

CHECKED BY: **JN**

APPROVED: *M.R.*

DRAWING NUMBER:

**5620**

v05

Page 643

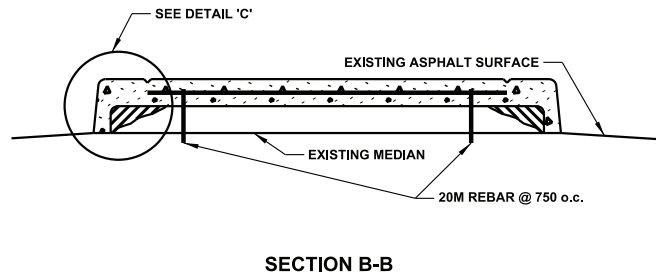
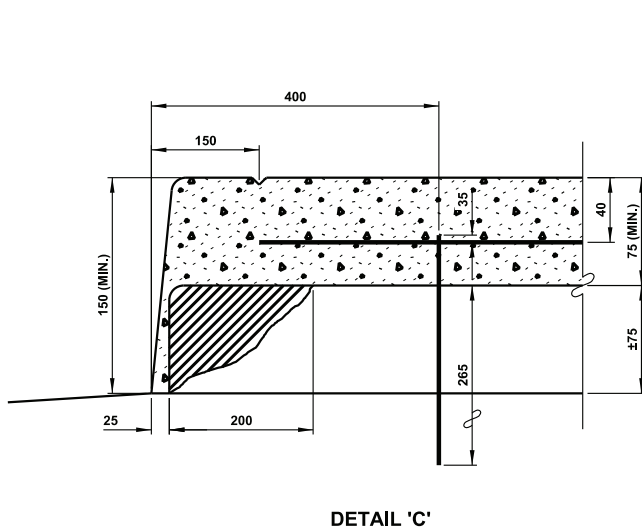
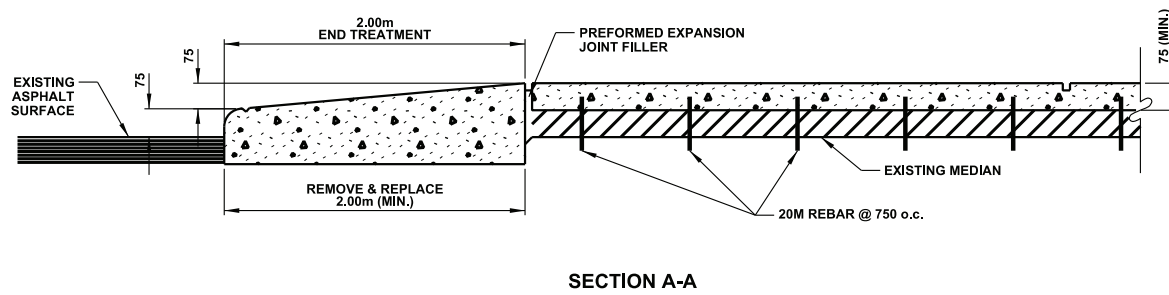
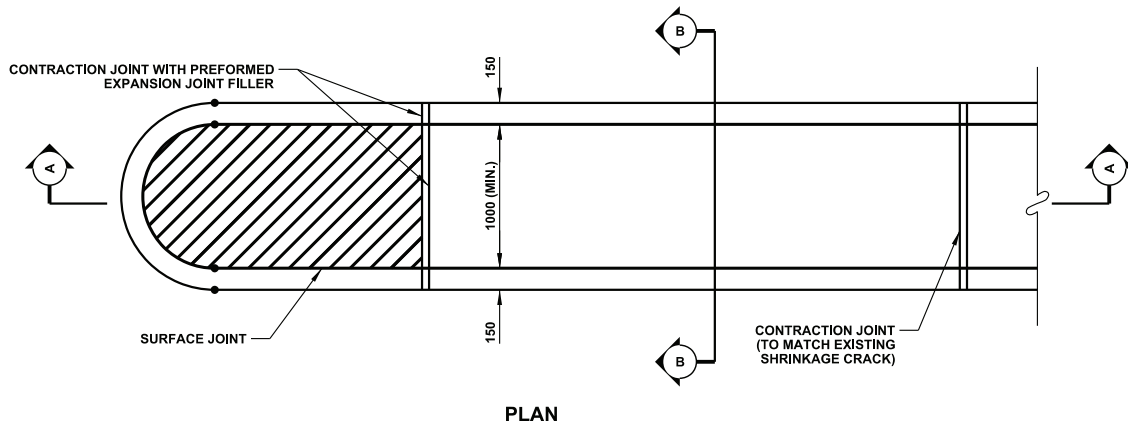

NOTES:

1. PREFORMED EXPANSION JOINT FILLER SHOULD ALSO BE PLACED AT MATCH TO EXISTING ISLAND.

**ALL DIMENSIONS  
IN MILLIMETRES UNLESS  
OTHERWISE NOTED**



STANDARD DRAWING

2023-08-31

**CENTER MEDIAN  
REHABILITATION**

DATE APPROVED: **2018**

DRAWN BY: **KSYC**

APPROVED: *M.R.*

DRAWING NUMBER: **5630**

SCALE: **N.T.S.**

CHECKED BY: **JN**

v05

Page 644

ALL DIMENSIONS  
IN METRES UNLESS  
OTHERWISE NOTED

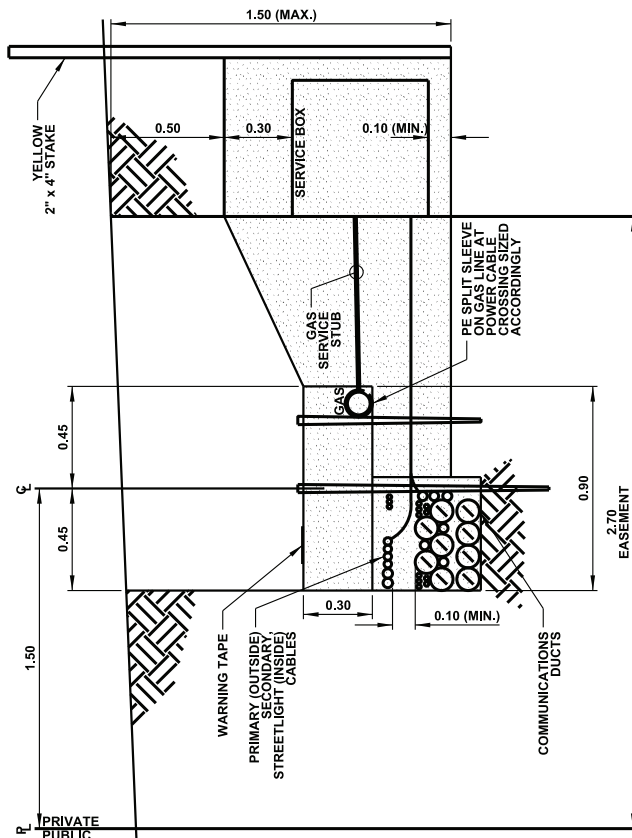

SERVICE TRENCH

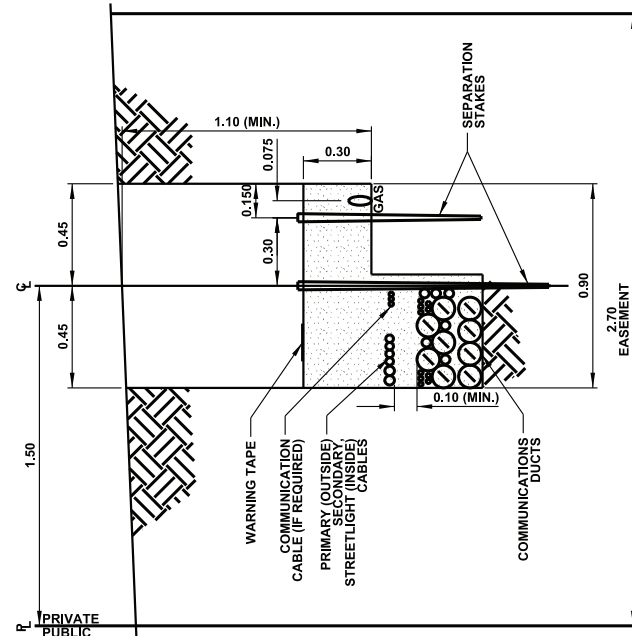

MAIN TRENCH DETAIL

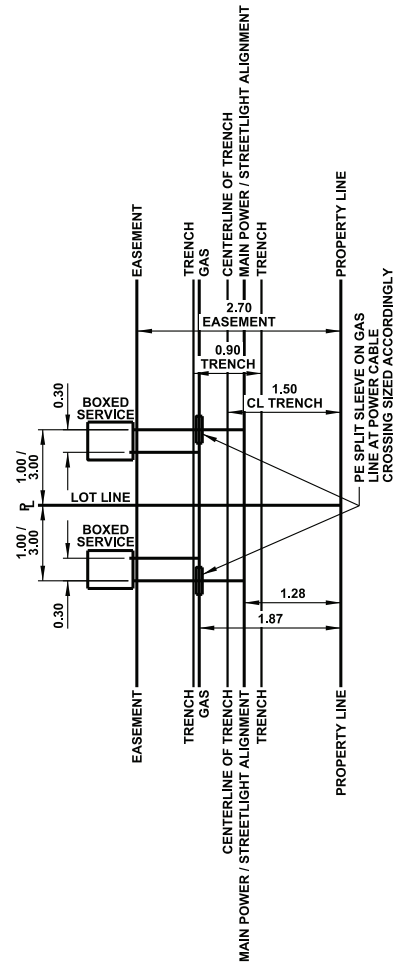

LOT SERVICE DETAIL

NOTES:

1. 1.50m MAXIMUM DEPTH TO THE BOTTOM OF POWER CABLES.



STANDARD DRAWING

2023-08-31

MULTI-PARTY UTILITIES TRENCHING

DATE APPROVED: **2018**

SCALE: **N.T.S.**

DRAWN BY: **KSYC**

CHECKED BY: **JN**

APPROVED: *M.R.*

DRAWING NUMBER:

**5700**

v05

Page 645



## Standard Drawings

### SECTION 6000 / 7000 – Miscellaneous

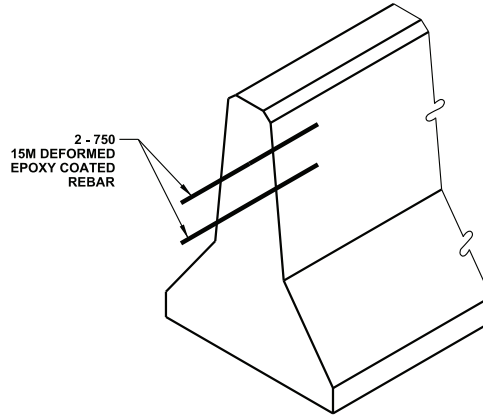
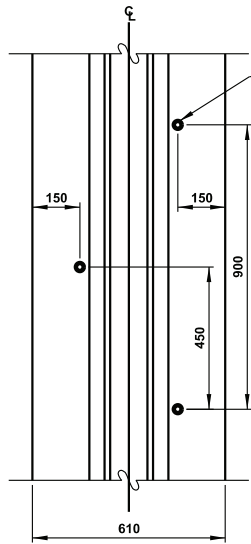

**CONSTRUCTION JOINT DETAIL**

**NOTE:**  
- CONSTRUCTION JOINT TO BE FILLED WITH JOINT FILLER

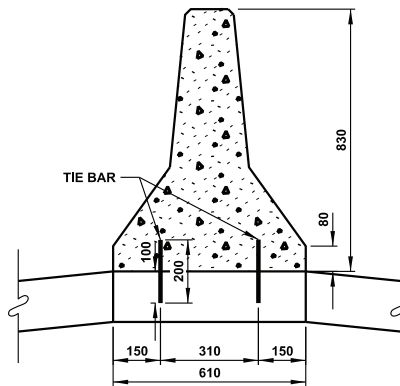

**TIE BAR DETAILS**

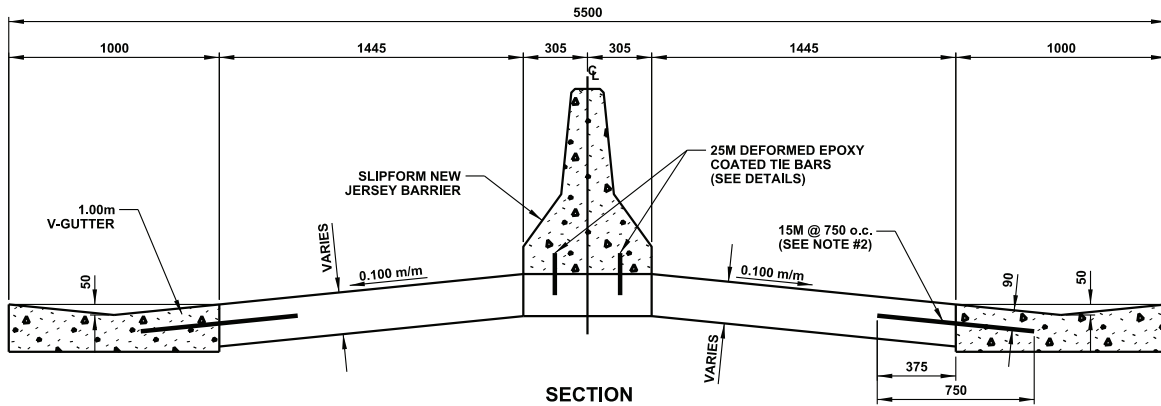

**SECTION**

**RETROFIT ONLY  
UTILIZE ALBERTA TRANSPORTATION  
SINGLE SLOPE BARRIER DESIGN  
FOR ALL NEW INSTALLS**

**ALL DIMENSIONS  
IN MILLIMETRES UNLESS  
OTHERWISE NOTED**

**NOTES:**

1. NO LONGITUDINAL REINFORCEMENT REQUIRED.
2. CONTRACTION JOINTS IN MEDIAN BARRIER TO BE MADE EVERY 5.00m (1/4 THE WIDTH OF BARRIER IN DEPTH).
3. NO JOINT SEALER REQUIRED.



STANDARD DRAWING

2023-08-31

**SLIPFORMED CONCRETE BARRIER 5.50m MEDIAN**

DATE APPROVED: **2018**

DRAWN BY: **KSYC**

APPROVED: *M.A.R.*

DRAWING NUMBER: **6010**

SCALE: **N.T.S.**

CHECKED BY: **JN**

v05

Page 647

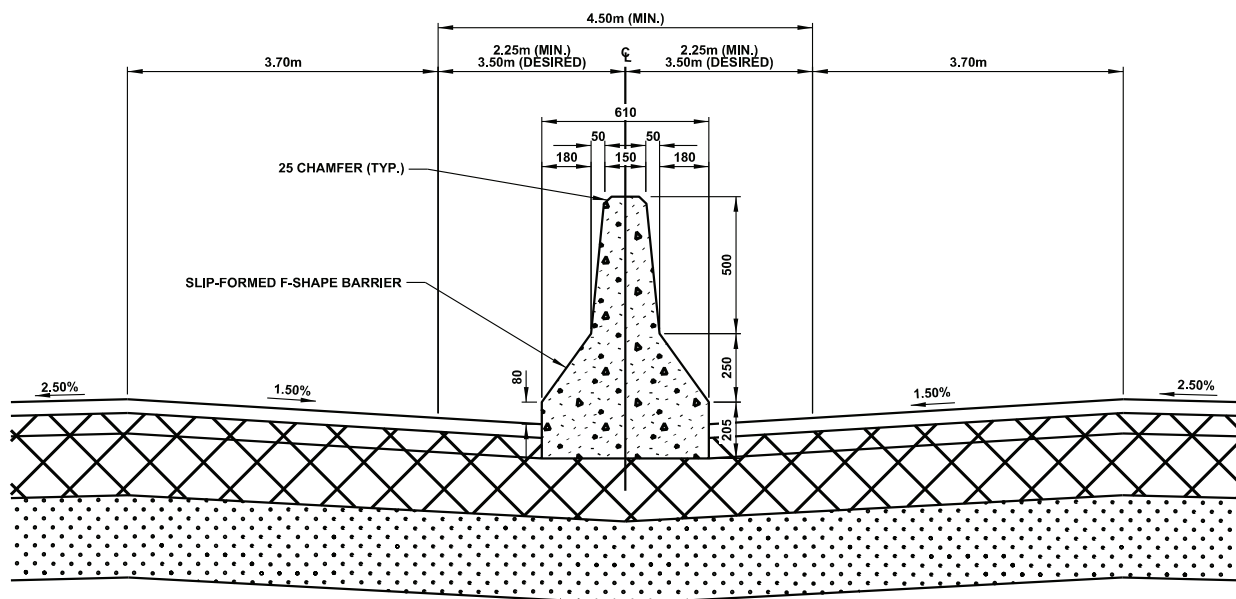

**RETROFIT ONLY  
UTILIZE ALBERTA TRANSPORTATION  
SINGLE SLOPE BARRIER DESIGN  
FOR ALL NEW INSTALLS**

**ALL DIMENSIONS  
IN MILLIMETRES UNLESS  
OTHERWISE NOTED**



**CONCRETE BARRIER ON PAVED MEDIAN**

DATE APPROVED: **2018**  
SCALE: **N.T.S.**

DRAWN BY: **KSYC**  
CHECKED BY: **JN**

APPROVED: *M.A.R.*

DRAWING NUMBER: **6020**



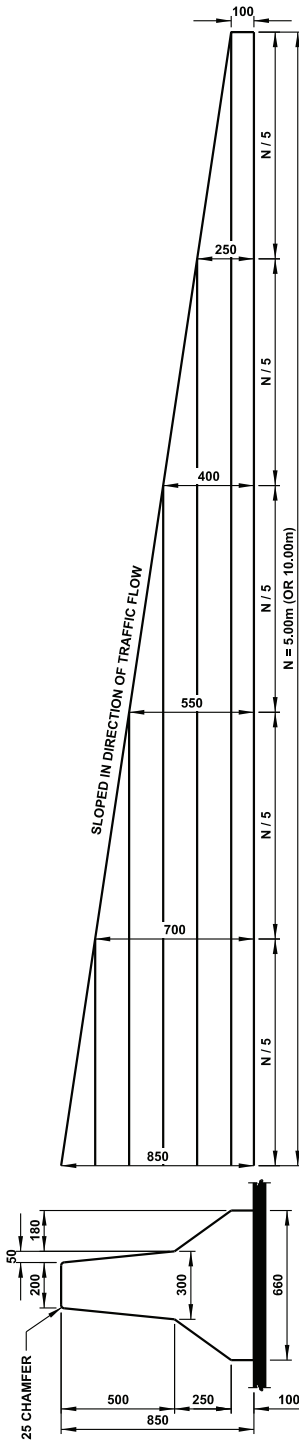

**N**  
(TAPERED END TREATMENT SLOPED)

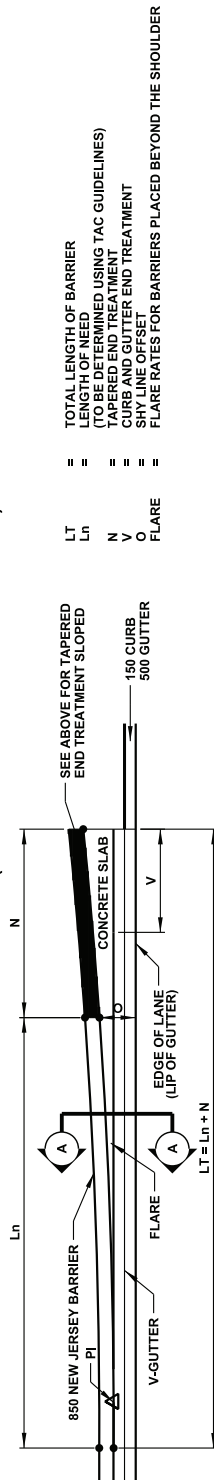

**NEW JERSEY BARRIER**  
TYPICAL FLARED END DETAILS

DESIGN SPEED (km/hr)	LT	N (m)	V (m)	FLARE	O
≤ 60	Ln + N	5	5	12:1	1.40
70	Ln + n	10	5	17:1	1:7
≥ 80	(THRIE - BEAM SYSTEM REQUIRED)				

\*IN SOME INSTANCES, TRANSITION COULD BE 1.00m V-GUTTER TO 250 GUTTER.

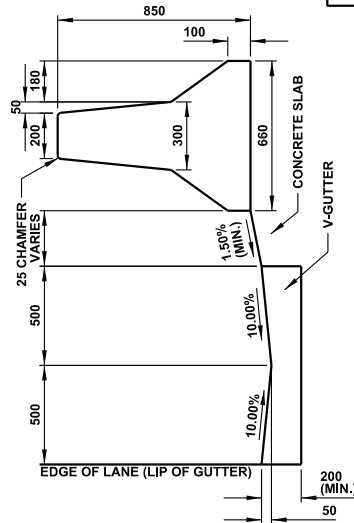

SECTION A-A

**RETROFIT ONLY**  
**UTILIZE ALBERTA TRANSPORTATION**  
**SINGLE SLOPE BARRIER DESIGN**  
**FOR ALL NEW INSTALLS**

**ALL DIMENSIONS**  
**IN MILLIMETRES UNLESS**  
**OTHERWISE NOTED**

NOTE:

- REFER TO TAC SECTION 3.1.6.5.9 FOR TAPER TO BE USED ONLY FOR 60km/hr SPEED, FLARING BEYOND THE CLEAR ZONE IS RECOMMENDED.



STANDARD DRAWING

2023-08-31

**END TRANSITION CONCRETE BARRIER**

DATE APPROVED: **2018**

SCALE: **N.T.S.**

DRAWN BY: **KSYC**

CHECKED BY: **JN**

APPROVED: *M.R.*

DRAWING NUMBER: **6030**

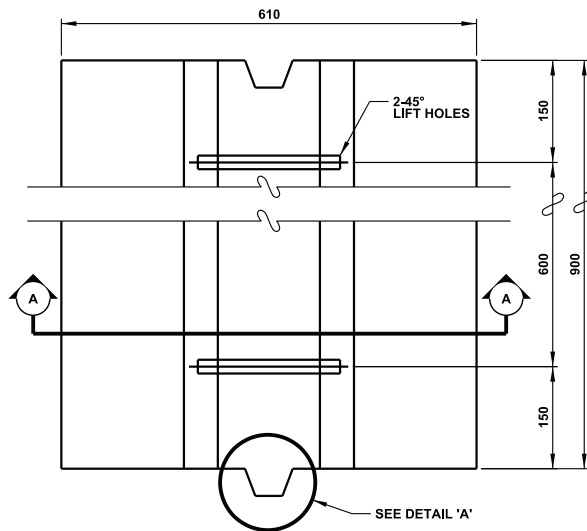

PLAN VIEW

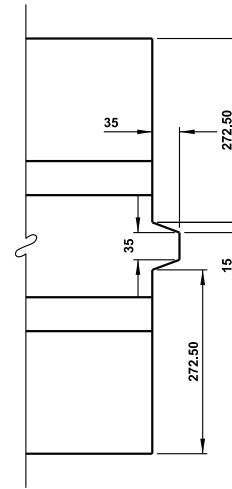

DETAIL 'A'

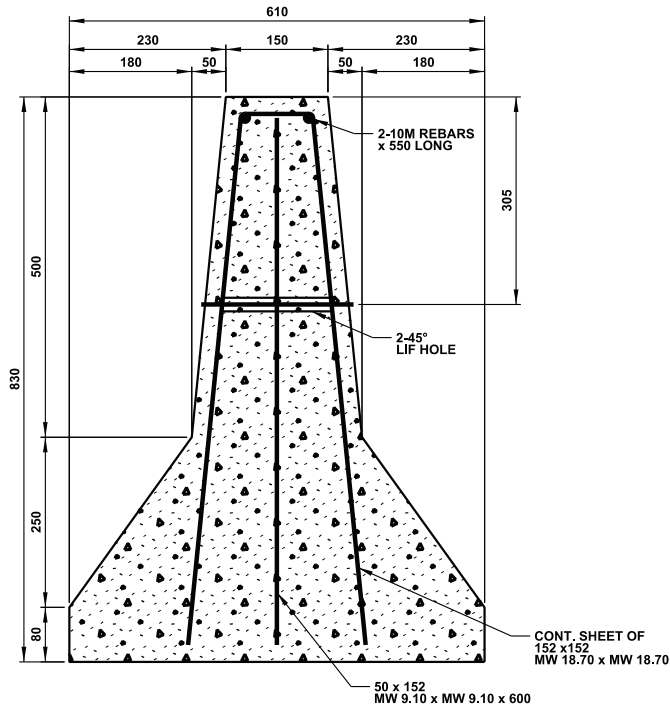

SECTION A-A

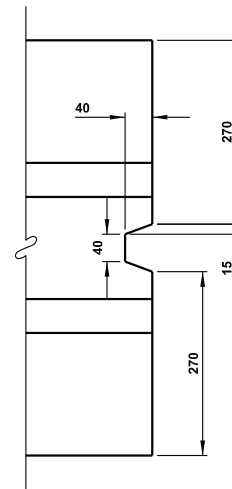

END OF SLIP FORMED BARRIER DETAIL

**RETROFIT ONLY  
UTILIZE ALBERTA TRANSPORTATION  
SINGLE SLOPE BARRIER DESIGN  
FOR ALL NEW INSTALLS**

**ALL DIMENSIONS  
IN MILLIMETRES UNLESS  
OTHERWISE NOTED**



STANDARD DRAWING

2023-08-31

LIFT OUT FOR CONCRETE BARRIER

DATE APPROVED: 2018

DRAWN BY: KSYC

APPROVED: *M.R.*

DRAWING NUMBER: 6050

SCALE: N.T.S.

CHECKED BY: JN

v05

Page 650

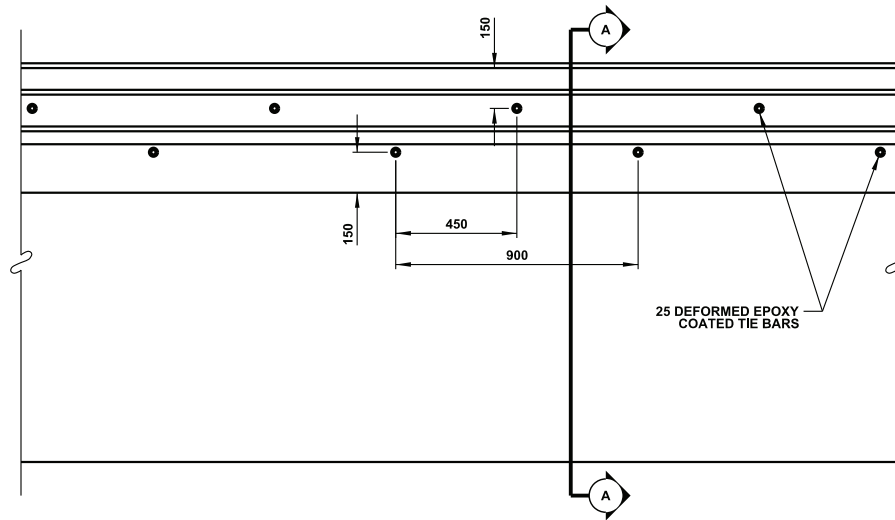

PLAN VIEW

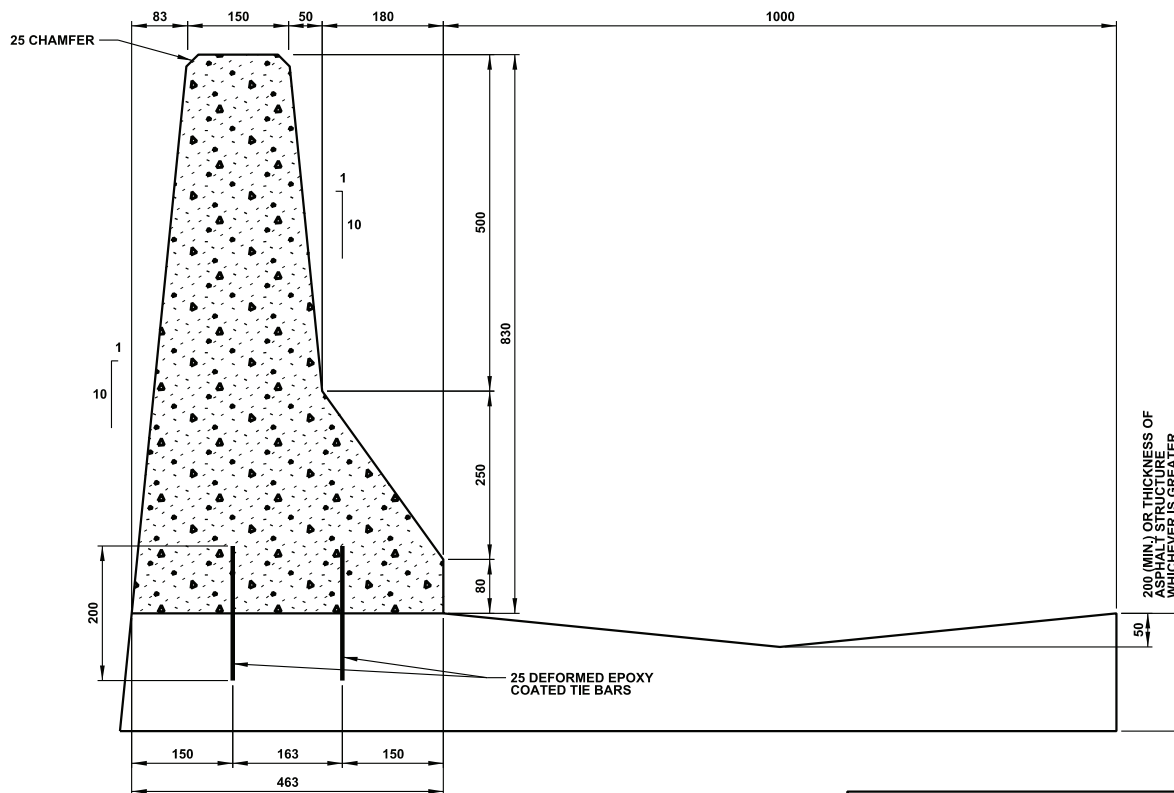

SECTION A-A

**RETROFIT ONLY  
UTILIZE ALBERTA TRANSPORTATION  
SINGLE SLOPE BARRIER DESIGN  
FOR ALL NEW INSTALLS**

**ALL DIMENSIONS  
IN MILLIMETRES UNLESS  
OTHERWISE NOTED**

**NOTES:**

1. FOR TIE BAR DETAIL SEE DRAWING #6010.
2. FOR CONSTRUCTION JOINT DETAIL SEE DRAWING #6010.



STANDARD DRAWING

2023-08-31

**830mm CONCRETE SLIP-FORMED PARAPET WITH 1.00m SWALE**

DATE APPROVED: **2018**

DRAWN BY: **KSYC**

APPROVED: *M.R.*

DRAWING NUMBER: **6060**

SCALE: **N.T.S.**

CHECKED BY: **JN**

v05

Page 651

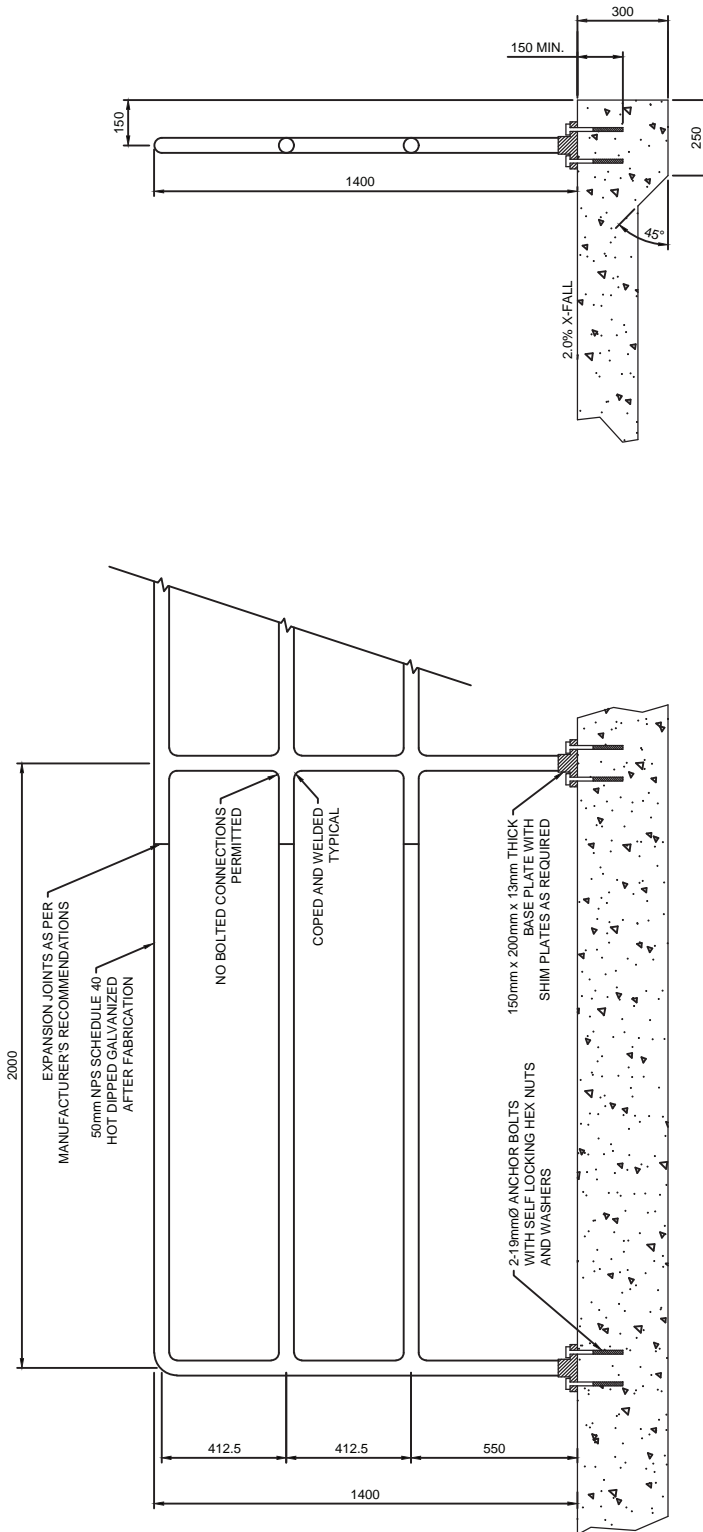

**ALL DIMENSIONS  
 IN MILLIMETRES UNLESS  
 OTHERWISE NOTED**

**HANDRAIL DETAILS**

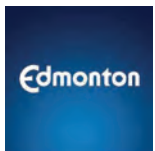

STANDARD DRAWING

2023-08-31

DATE APPROVED: **2023**

SCALE: **N.T.S.**

DRAWN BY: **RF**

CHECKED BY: **MW**

APPROVED: DocuSigned by: *Matthew Ivany*

AB984D7343E14A9...

DRAWING NUMBER:

**6085**

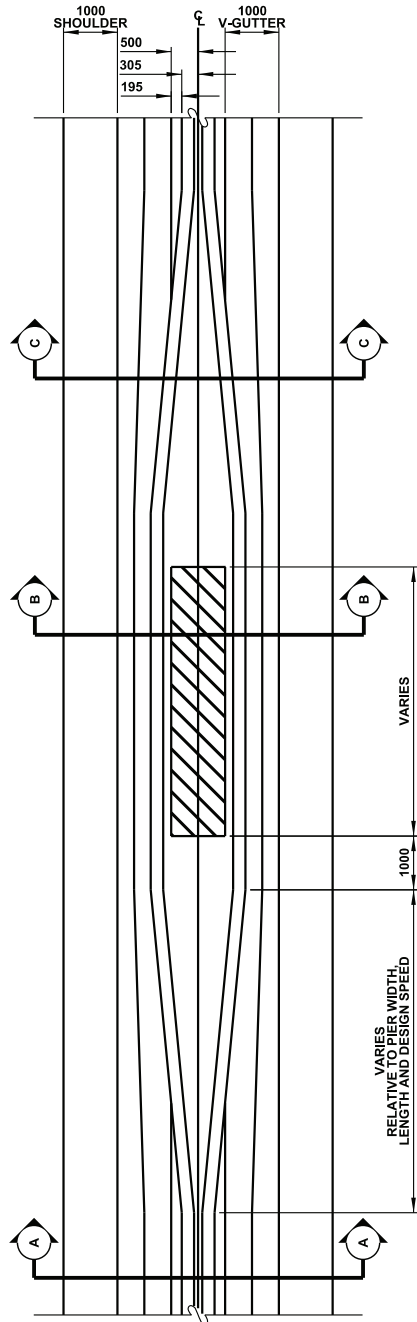

PLAN VIEW

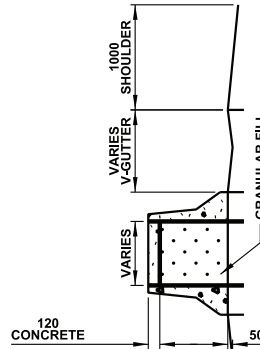

SECTION C-C

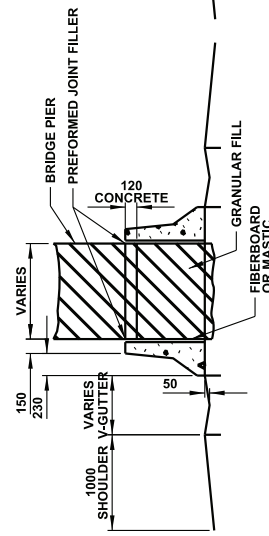

SECTION B-B

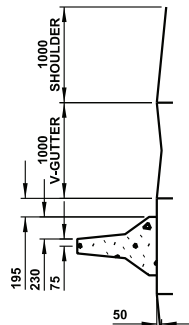

SECTION A-A

**RETROFIT ONLY  
UTILIZE ALBERTA TRANSPORTATION  
SINGLE SLOPE BARRIER DESIGN  
FOR ALL NEW INSTALLS**

**ALL DIMENSIONS  
IN MILLIMETRES UNLESS  
OTHERWISE NOTED**

**NOTES:**

1. WIDTH AND LENGTHS WILL VARY.
2. CONCRETE BARRIER TO MAINTAIN STANDARD FACE DIMENSION THROUGHOUT SEE DRAWING #6001.



STANDARD DRAWING

2023-08-31

**STANDARD TAPER AT BRIDGE PIERS CONCRETE BARRIER**

DATE APPROVED: **2018**

DRAWN BY: **KSYC**

APPROVED: *M.R.*

DRAWING NUMBER: **6090**

SCALE: **N.T.S.**

CHECKED BY: **JN**

v05

Page 653

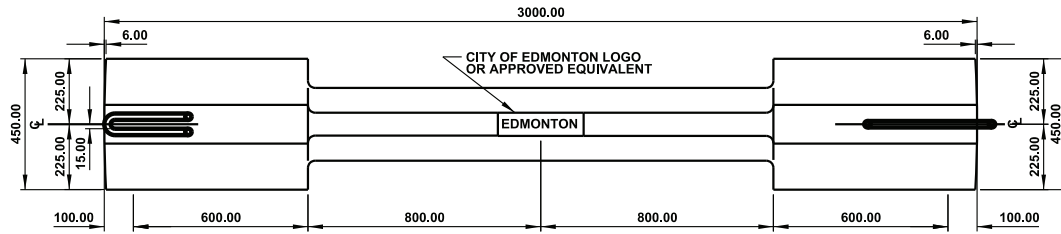

PLAN VIEW

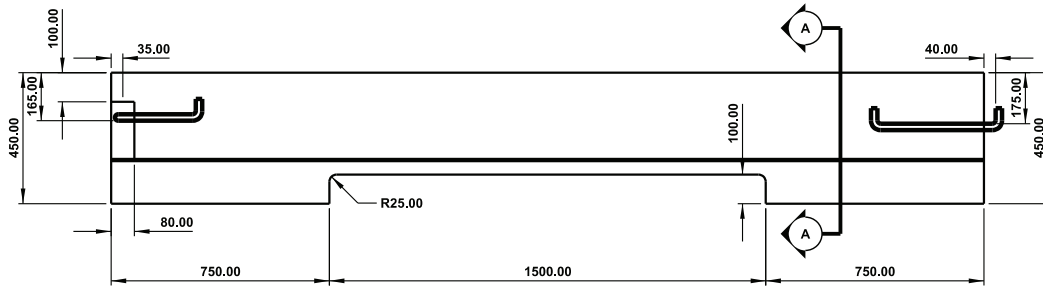

ELEVATION

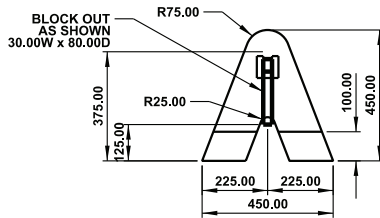

LEFT END VIEW

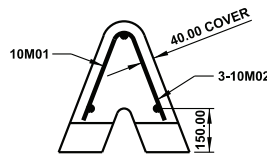

SECTION A-A

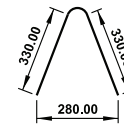

10M01

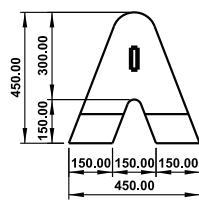

RIGHT END VIEW

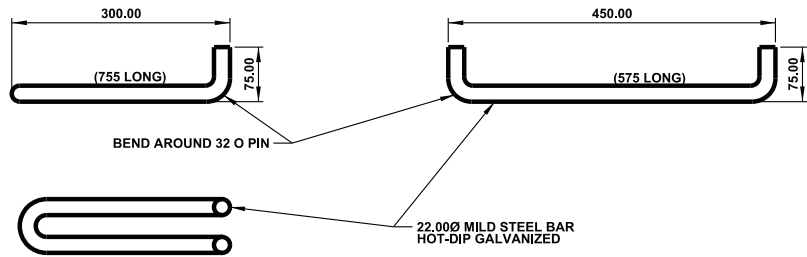

STEEL BAR DETAIL

NOTES:

1. CLASS "C" CONCRETE

ALL DIMENSIONS  
IN MILLIMETRES UNLESS  
OTHERWISE NOTED



STANDARD DRAWING

2023-08-31

PRE-CAST CONCRETE MINI-BARRIER

DATE APPROVED: 2018

DRAWN BY: KSYC

APPROVED: *M.R.*

DRAWING NUMBER: 6100

SCALE: N.T.S.

CHECKED BY: JN

v05

Page 654

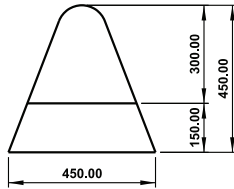

LEFT END VIEW

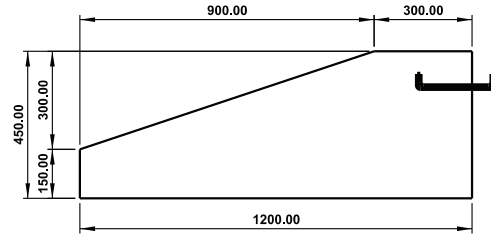

ELEVATION

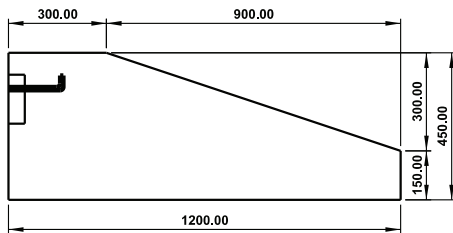

ELEVATION

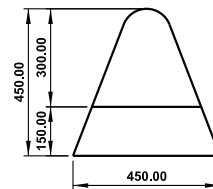

RIGHT END VIEW

NOTES:

- 1. CLASS "C" CONCRETE.
- 2. FOR STEEL DETAIL SEE DRAWING #6100.

**ALL DIMENSIONS  
IN MILLIMETRES UNLESS  
OTHERWISE NOTED**



STANDARD DRAWING

2023-08-31

**END TRANSITION PRE-CAST CONCRETE MINI-BARRIER**

DATE APPROVED: **2018**

DRAWN BY: **KSYC**

APPROVED: *M.A.R.*

DRAWING NUMBER: **6101**

SCALE: **N.T.S.**

CHECKED BY: **JN**

v05

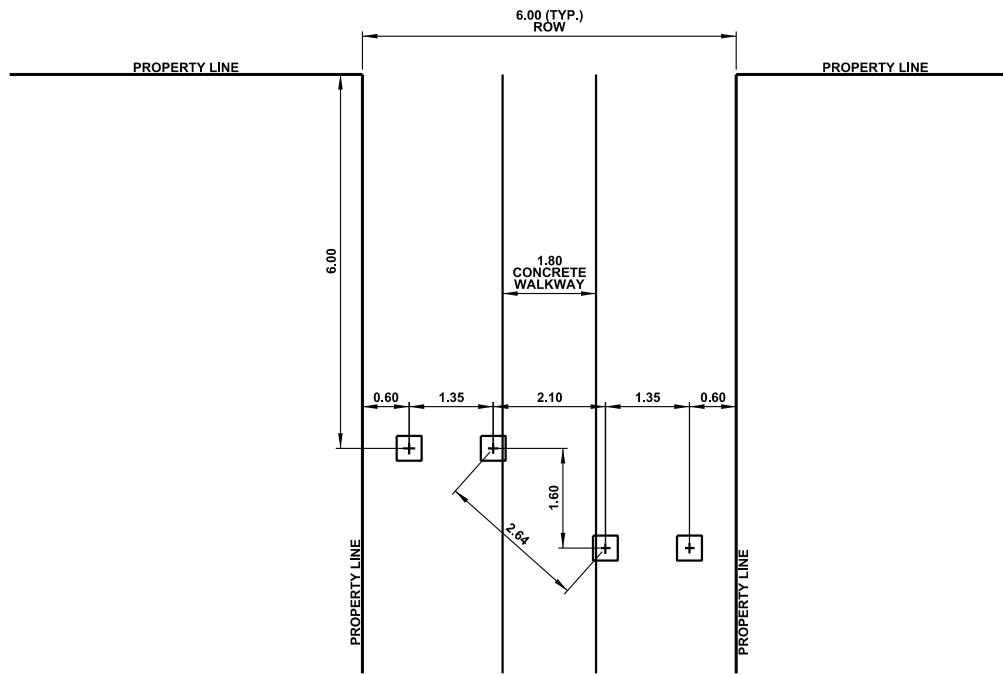

TYPICAL BOLLARD LAYOUT

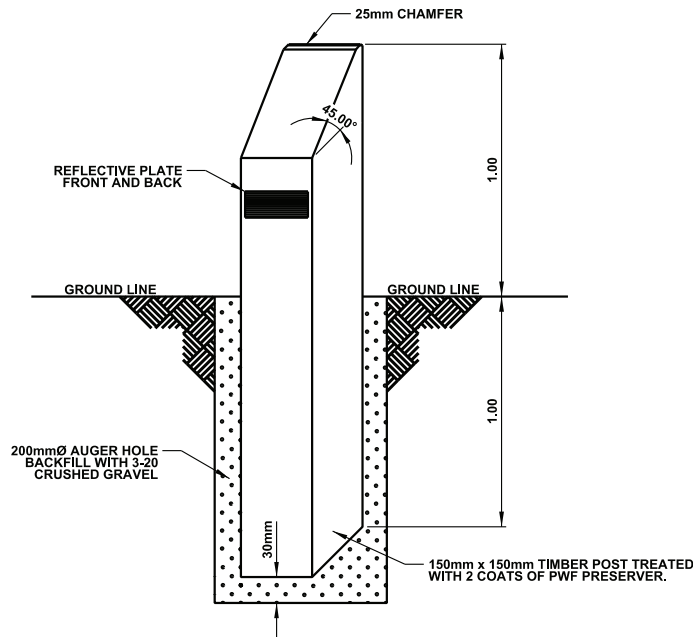

BOLLARD DETAIL

LEGEND:

 BOLLARD

NOTES:

1. HAND TREAT ALL CUTS WITH PWF PRESERVER.
2. REQUIREMENT AND LOCATION OF BOLLARDS ARE SUBJECT TO CITY OF EDMONTON APPROVAL.

**ALL DIMENSIONS  
IN METRES UNLESS  
OTHERWISE NOTED**



STANDARD DRAWING

**TYPICAL BOLLARD LAYOUT AND INSTALLATION  
FOR 1.80m CONCRETE WALKWAYS**

DATE APPROVED: <b>2018</b>	DRAWN BY: <b>KSYC</b>	APPROVED: 	DRAWING NUMBER: <b>6200</b>
SCALE: <b>N.T.S.</b>	CHECKED BY: <b>JN</b>		



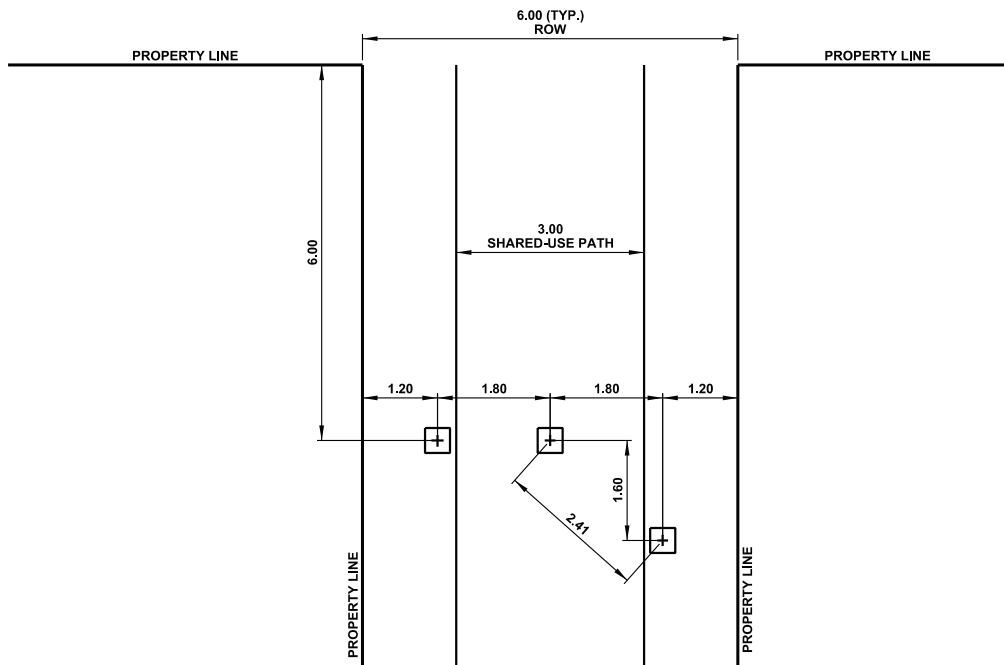

TYPICAL BOLLARD LAYOUT

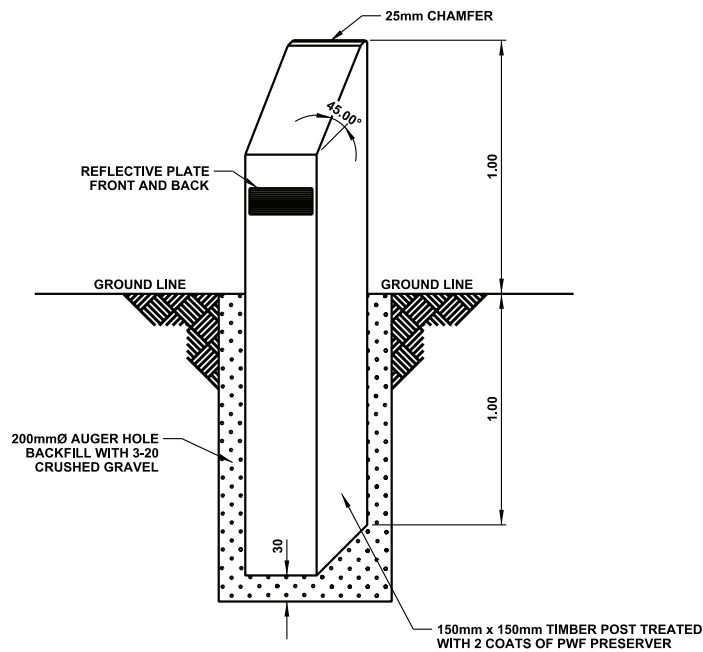

BOLLARD DETAIL

LEGEND:

 BOLLARD

NOTES:

1. HAND TREAT ALL CUTS WITH PWF PRESERVER.
2. REQUIREMENT AND LOCATION OF BOLLARDS ARE SUBJECT TO CITY OF EDMONTON APPROVAL.

**ALL DIMENSIONS  
IN METRES UNLESS  
OTHERWISE NOTED**



STANDARD DRAWING

2023-08-31

**TYPICAL BOLLARD LAYOUT AND INSTALLATION  
FOR 3.00m SHARED-USE PATH**

DATE APPROVED: **2018**

DRAWN BY: **KSYC**

APPROVED: 

DRAWING NUMBER: **6210**

SCALE: **N.T.S.**

CHECKED BY: **JN**

v05

Page 657

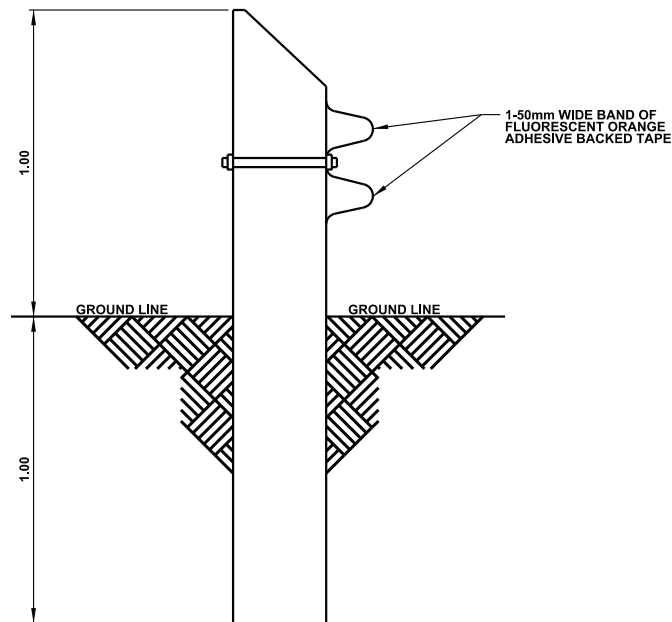
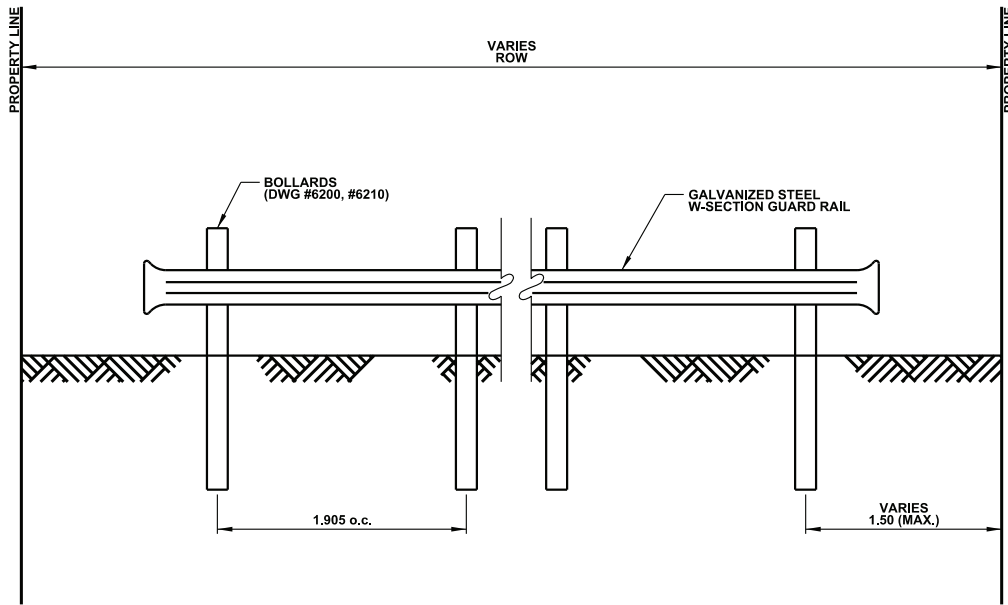

NOTES:

- 1. ALL HARDWARE TO BE GALVANIZED.

**ALL DIMENSIONS  
IN METRES UNLESS  
OTHERWISE NOTED**

**TYPICAL BOLLARD WITH  
GALVANIZED STEEL W-SECTION**



STANDARD DRAWING

2023-08-31

DATE APPROVED: **2018**

SCALE: **N.T.S.**

DRAWN BY: **KSYC**

CHECKED BY: **JN**

APPROVED: *M.A.R.*

DRAWING NUMBER:

**6220**

v05

Page 658

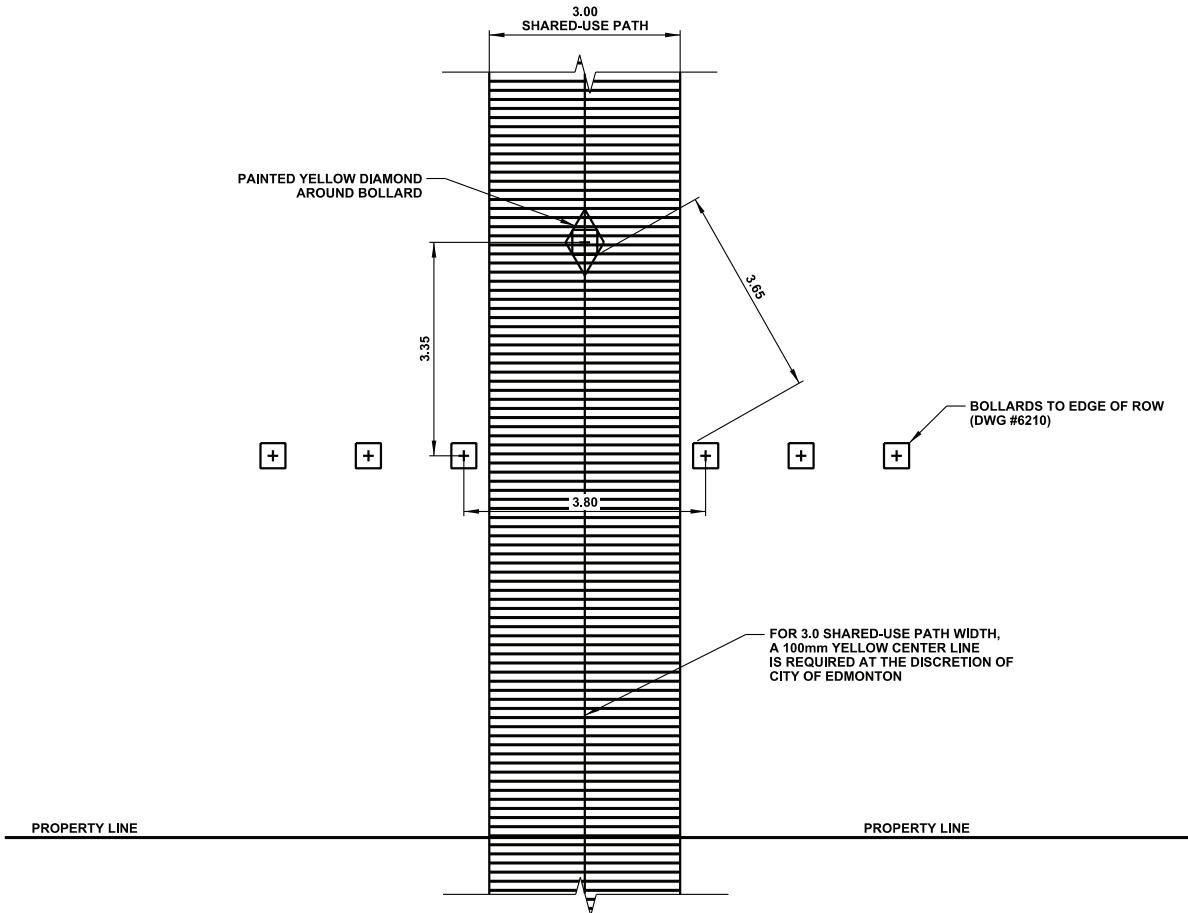

LEGEND:

 BOLLARD

NOTES:

1. REQUIREMENT AND LOCATION OF CENTER BOLLARD WITHIN SHARED-USE PATH IS SUBJECT TO CITY OF EDMONTON APPROVAL.

**ALL DIMENSIONS  
IN METRES UNLESS  
OTHERWISE NOTED**



STANDARD DRAWING

2023-08-31

**TYPICAL BOLLARD LAYOUT  
FOR 3.00m ASPHALT SHARED-USE PATH  
WITHIN PIPELINE / POWER ROW**

DATE APPROVED: **2018**

DRAWN BY: **KSYC**

APPROVED: 

DRAWING NUMBER: **6230**

SCALE: **N.T.S.**

CHECKED BY: **JN**

v05

Page 659

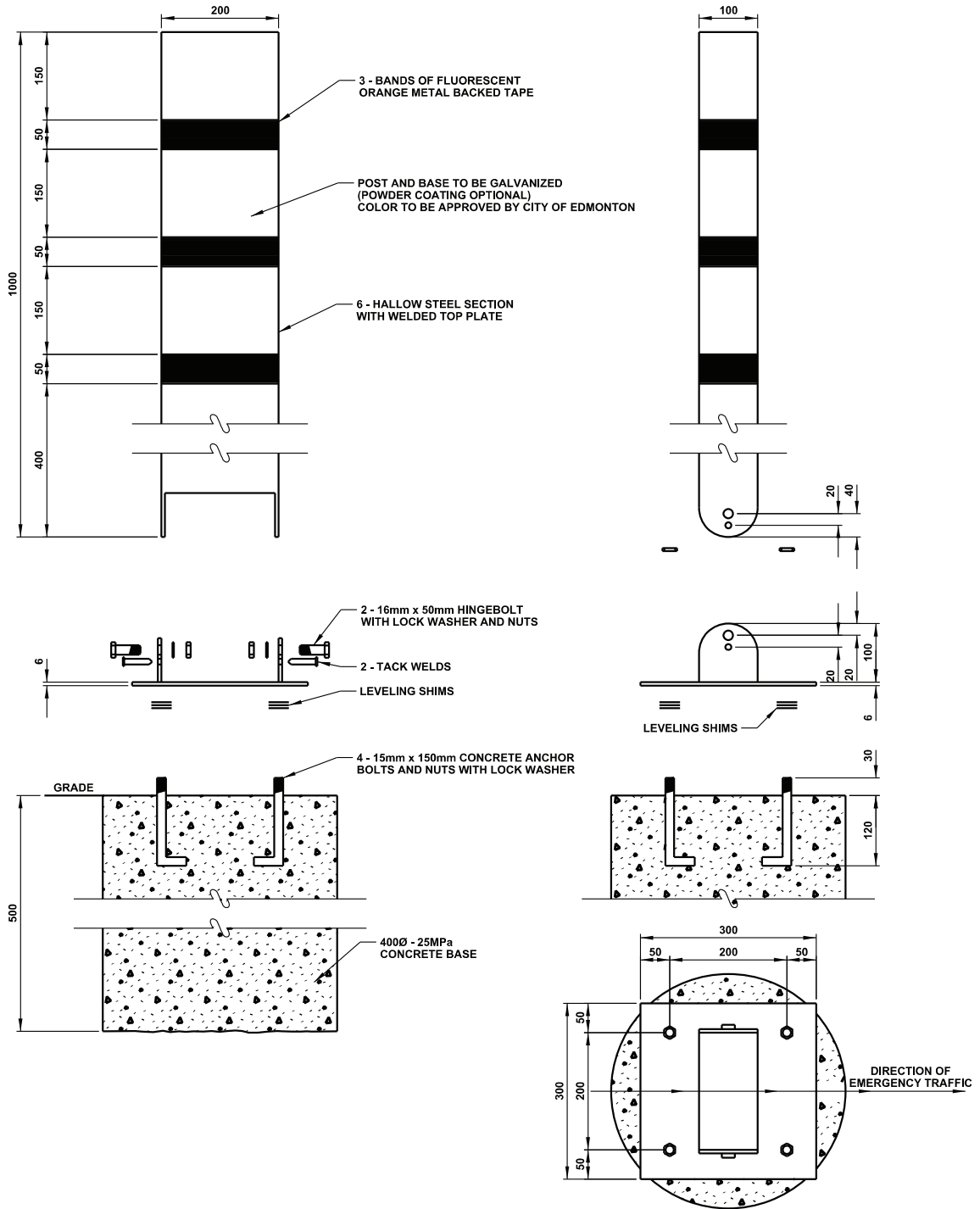

**ALL DIMENSIONS  
IN MILLIMETRES UNLESS  
OTHERWISE NOTED**



**EMERGENCY KNOCK-DOWN POST (RETROFIT)**

DATE APPROVED: **2018**  
SCALE: **N.T.S.**

DRAWN BY: **KSYC**  
CHECKED BY: **JN**

APPROVED: *M.A.R.*

DRAWING NUMBER: **6240**

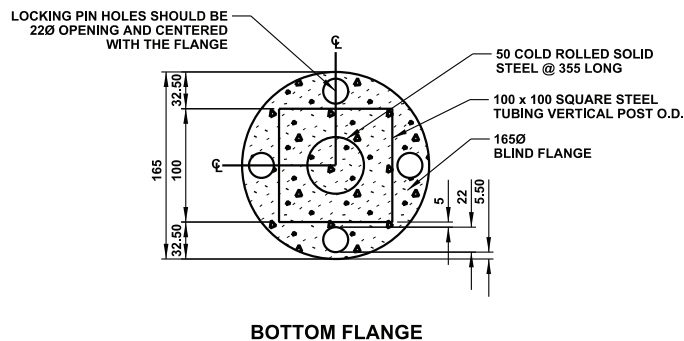
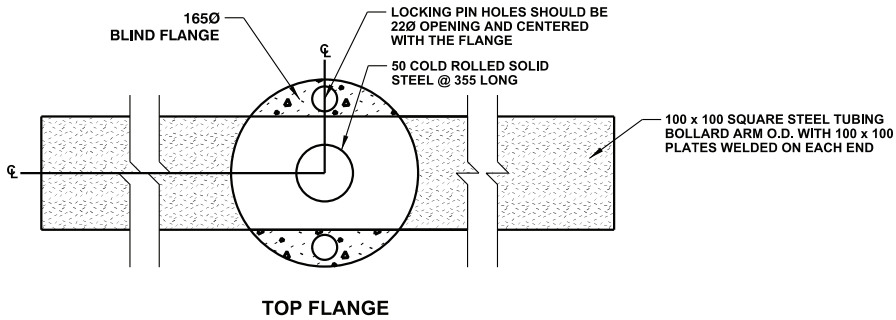
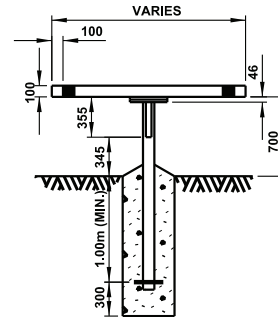
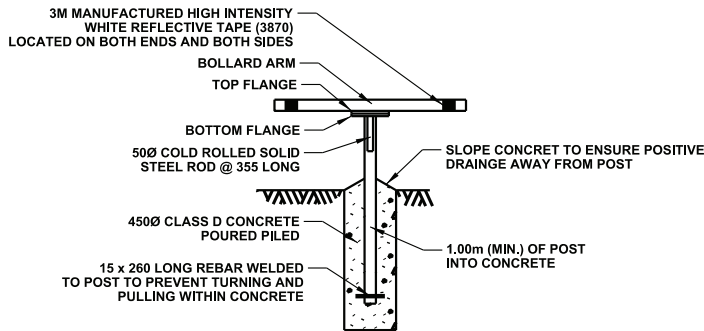
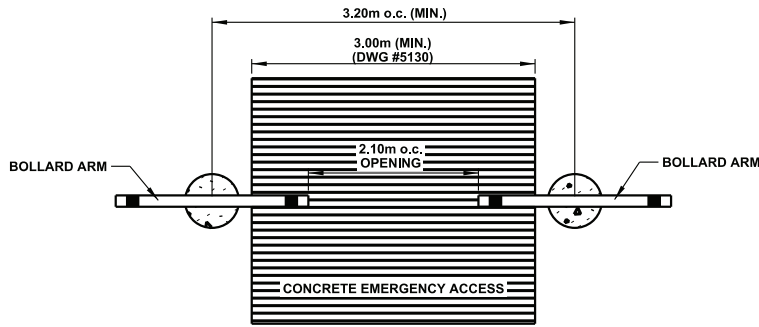

**NOTES:**

1. ALL METAL TO BE GALVANIZED. (POWDER COATING OPTIONAL) COLOR TO BE APPROVED BY CITY OF EDMONTON.
2. USE OF T-BOLLARDS TO BE AT DISCRETION OF CITY OF EDMONTON.

**REFER TO DRAWING #6251 FOR T-BOLLARD ASSEMBLY DETAIL**

---

**ALL DIMENSIONS IN MILLIMETRES UNLESS OTHERWISE NOTED**

**T-BOLLARD IN EMERGENCY ACCESS**



STANDARD DRAWING

DATE APPROVED: **2018**

DRAWN BY: **KSYC**

APPROVED: *M.A.R.*

DRAWING NUMBER: **6250**

SCALE: **N.T.S.**

CHECKED BY: **JN**

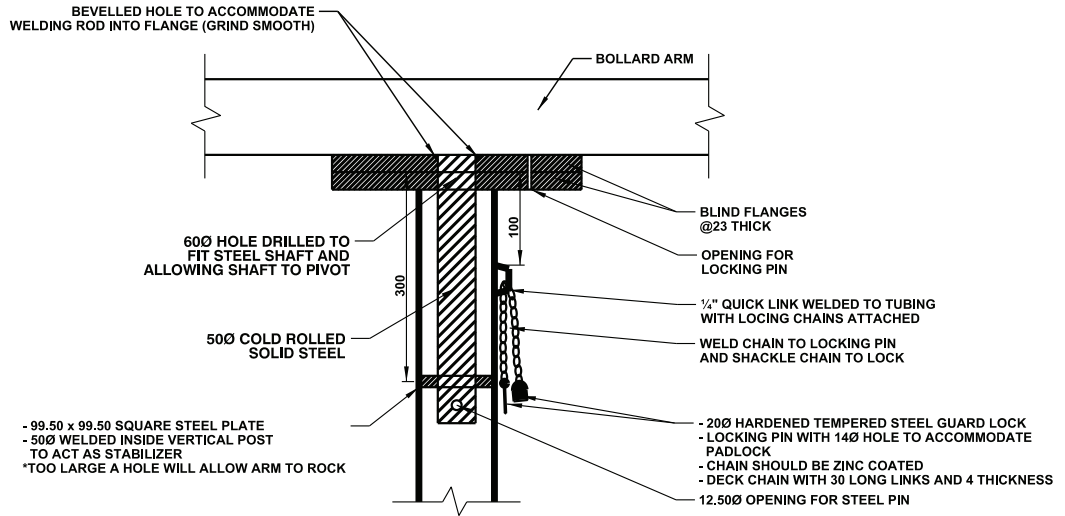

ASSEMBLY DETAIL

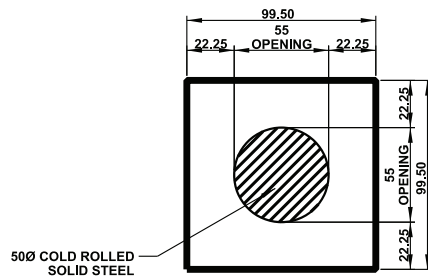
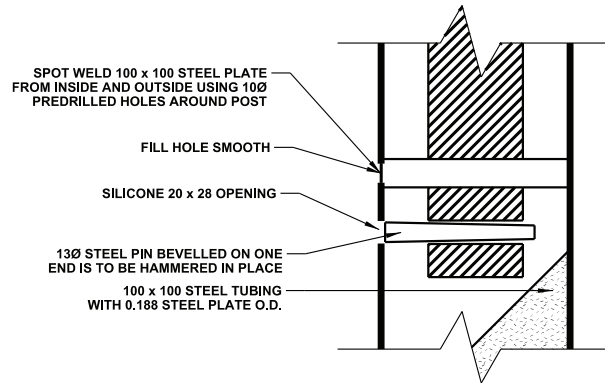
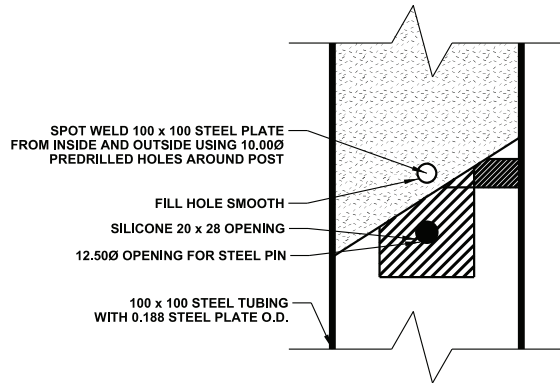

99.50 x 99.50 SQUARE STEEL PLATE

NOTES:

1. ALL METAL TO BE GALVANIZED. (POWDER COATING OPTIONAL) COLOR TO BE APPROVED BY CITY OF EDMONTON.

ALL DIMENSIONS IN MILLIMETRES UNLESS OTHERWISE NOTED



STANDARD DRAWING

2023-08-31

T-BOLLARD ASSEMBLY DETAIL

DATE APPROVED: 2018

DRAWN BY: KSYC

APPROVED: *M.A.R.*

DRAWING NUMBER: 6251

SCALE: N.T.S.

CHECKED BY: JN

v05

Page 662

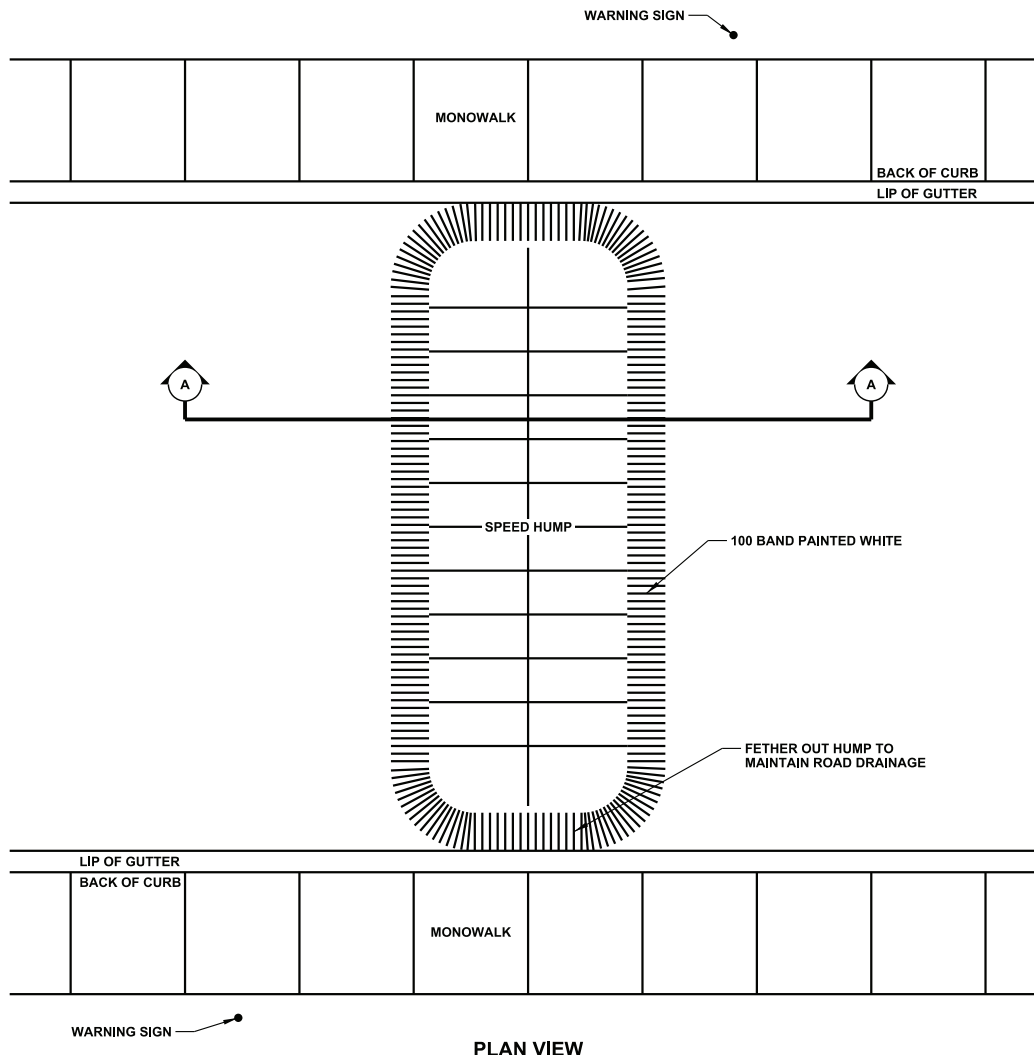

PLAN VIEW

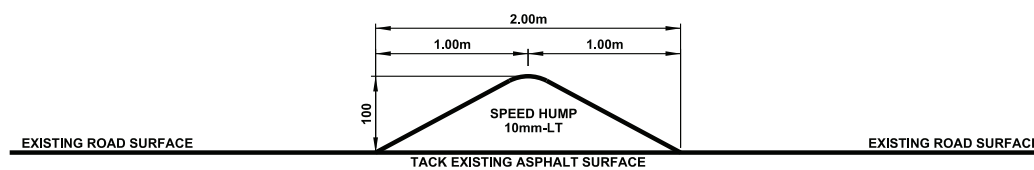

SECTION A-A

TAC CLASSIFICATION U.L.U. 50

ALL DIMENSIONS IN MILLIMETRES UNLESS OTHERWISE NOTED

ASPHALT SPEED HUMP



STANDARD DRAWING

2023-08-31

DATE APPROVED: 2018

SCALE: N.T.S.

DRAWN BY: KSYC

CHECKED BY: JN

APPROVED: *M.L.R.*

DRAWING NUMBER: 6300

Page 663

v05

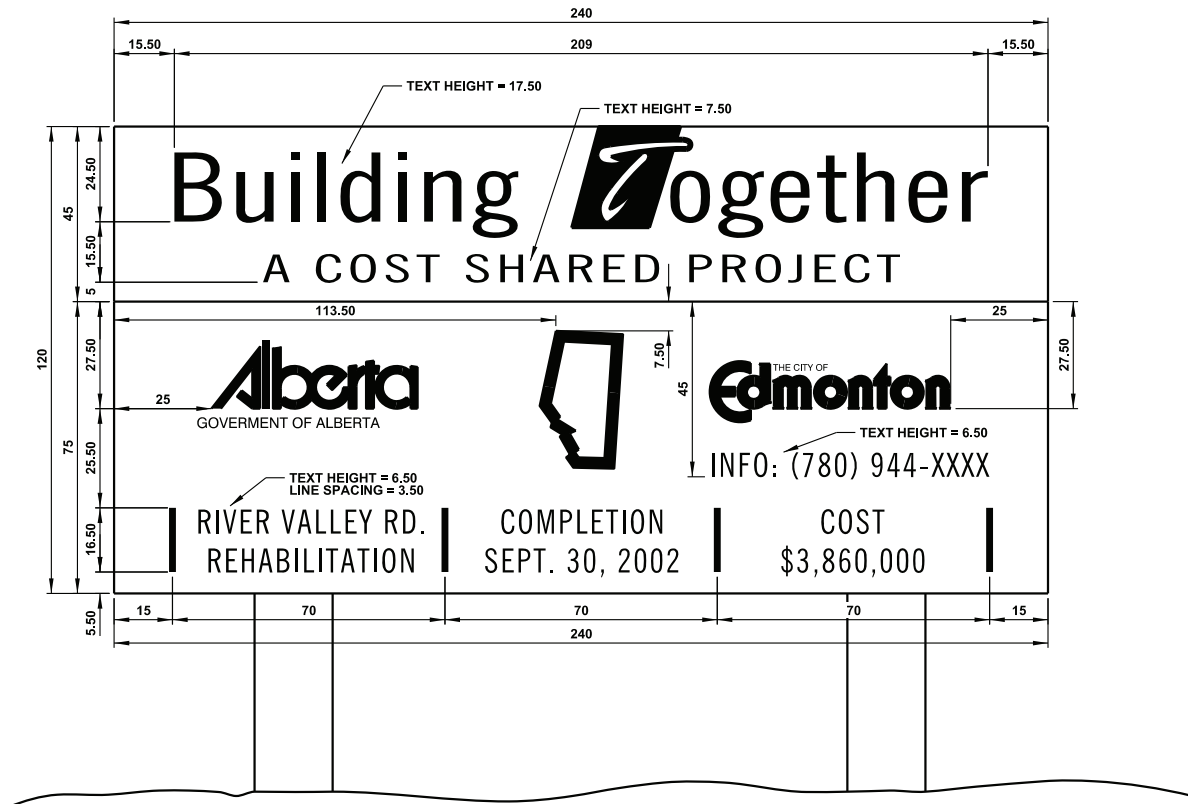

**SIGNAGE SPECIFICATION:**

**DIMENSIONS:** 240 x 120

**MATERIAL:** HIGH INTENSITY GRADE REFLECTIVE SHEETING  
19mm HIGH DENSITY OVERLAY FIR PLYWOOD

**COLOR:** TOP: BACKGROUND - WHITE  
MESSAGE - BLUE (PMS 286)  
BOTTOM: BACKGROUND - BLUE (PMS 286)  
MESSAGE - WHITE

**LETTER STYLE:** GILL SANS BOLD

**NOTES:** LETTER SPACING TO BE DETERMINED WHEN EACH SIGN IS FABRICATED

**ALL DIMENSIONS  
IN CENTIMETRES UNLESS  
OTHERWISE NOTED**



**COST SHARE PROJECT SIGN**

DATE APPROVED: **2018**  
SCALE: **N.T.S.**

DRAWN BY: **KSYC**  
CHECKED BY: **JN**

APPROVED: *M.A.R.*

DRAWING NUMBER: **6500**



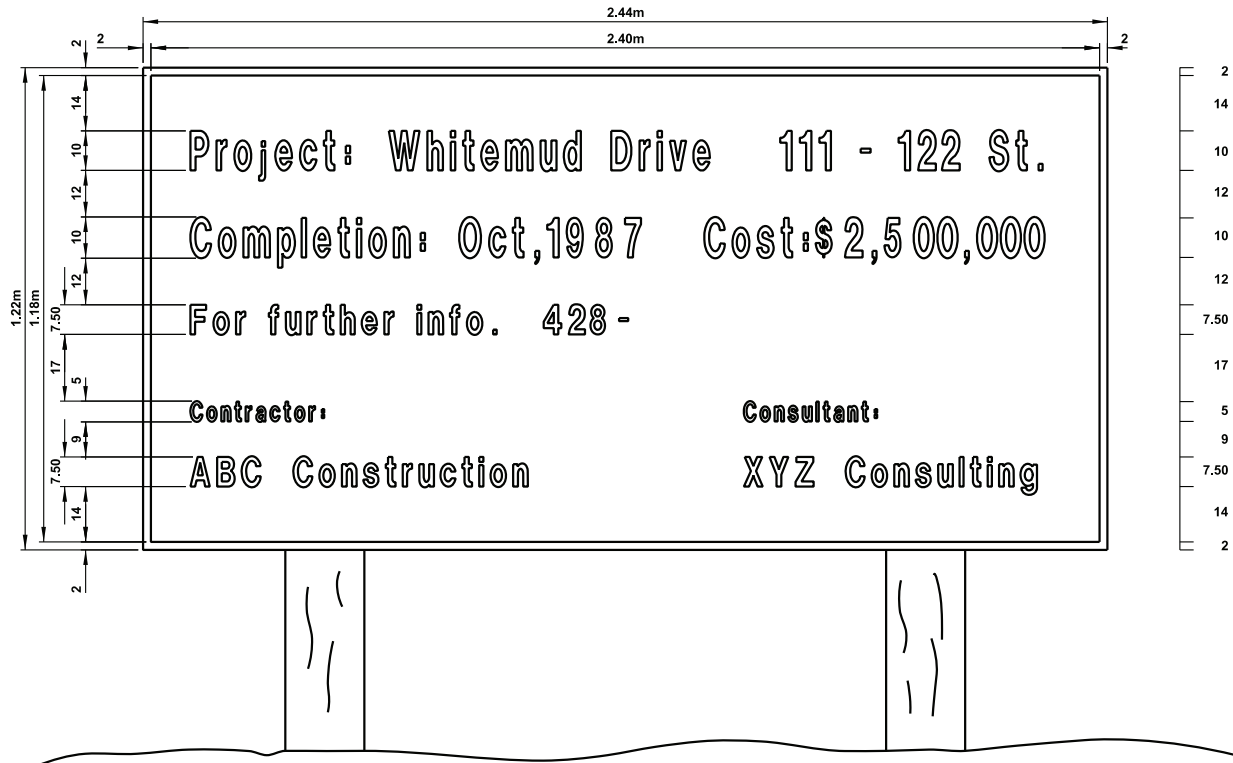

**SIGNAGE SPECIFICATION:**

**DIMENSION:** 240 x 120

**MATERIALS:** HIGH INTENSITY GRADE REFLECTIVE SHEETING 2870 - SILVER (SCOTCHLITE)  
19mm HIGH DENSITY OVERLAY FIR PLYWOOD

**INK:** 810 TRANSPARENT BLUE 3M

**COLOR:** TRANSPARENT BLUE ON SILVER BACKGROUND

**LETTER STYLE:** COOPER BLACK ITALIC AND HELVETICA MEDIUM - SIZES AS SHOWN ABOVE

**NOTES:** LETTER SPACING TO BE DETERMINED WHEN EACH SIGN IS FABRICATED

**COST:** CONTRACT DOLLAR (\$) AMOUNT TO NEAREST 100,000

**ALL DIMENSIONS  
IN CENTIMETRES UNLESS  
OTHERWISE NOTED**

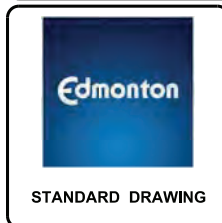

**AUXILIARY PROJECT SIGN**

DATE APPROVED: **2018**

DRAWN BY: **KSYC**

APPROVED: *M.R.*

DRAWING NUMBER: **6510**

SCALE: **N.T.S.**

CHECKED BY: **JN**

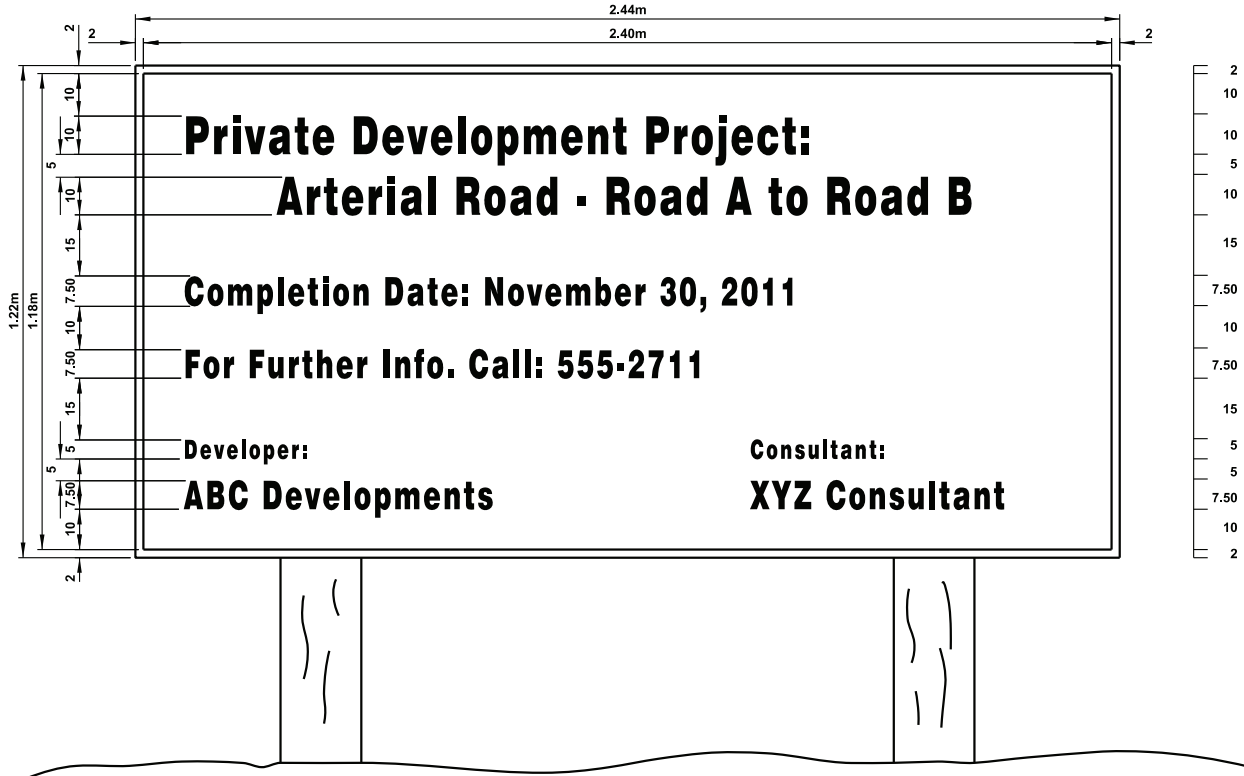

**SIGNAGE SPECIFICATION:**

**DIMENSION:** 240 x 120

**MATERIALS:** HIGH INTENSITY GRADE REFLECTIVE SHEETING 3870 - SILVER (HIGH INTENSITY SCOTCHLITE)  
19mm HIGH DENSITY OVERLAY FIR PLYWOOD

**INK:** 810 TRANSPARENT BROWN 3M

**COLOR:** TRANSPARENT BROWN ON SILVER BACKGROUND

**LETTER STYLE:** HELVETICA MEDIUM OR CLEAR VIEW FONT - SIZES AS SHOWN ABOVE

**NOTES:** LETTER SPACING TO BE DETERMINED WHEN EACH SIGN IS FABRICATED

**ALL DIMENSIONS  
IN CENTIMETRES UNLESS  
OTHERWISE NOTED**

**ARTERIAL ROAD PROJECT SIGN  
DEVELOPER-BUILT PROJECTS**



STANDARD DRAWING

DATE APPROVED: **2018**

DRAWN BY: **KSYC**

APPROVED: *M.R.*

DRAWING NUMBER: **6520**

SCALE: **N.T.S.**

CHECKED BY: **JN**

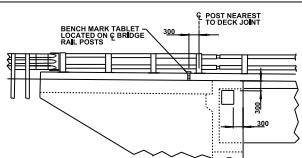

**PLAQUE AND BENCH MARK TABLET LOCATION FOR MAJOR BRIDGE**  
1.30

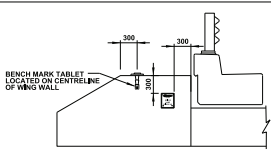

**CONCRETE WINGWALL**  
1.30

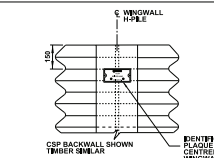

**TIMBER OR CORRUGATED BACKWALL**  
(CSP BACKWALL SHOWN TIMBER SIMILAR) 1.30

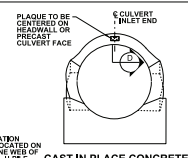

**CAST IN PLACE CONCRETE HEADWALLS AND PRECAST CULVERTS**  
(CSP SHOWN, PRECAST SIMILAR) N.T.S.

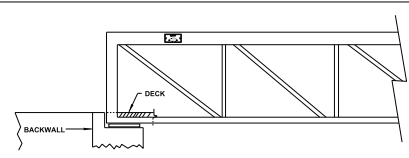

**PEDESTRIAN TRUSS BRIDGE**

**PLAQUE AND BENCH MARK TABLET LOCATION FOR STANDARD BRIDGE/CULVERTS/PEDESTRIAN TRUSS BRIDGES**

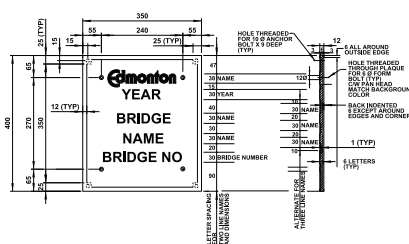
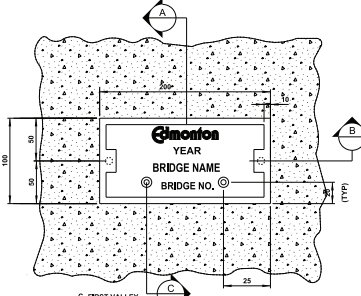

**CASTING DETAILS**  
1.3

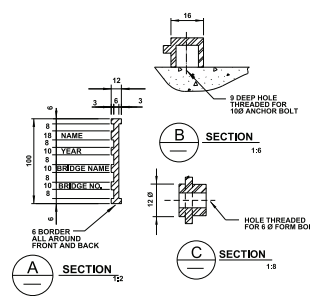

**SECTION A**  
1.3

**SECTION B**  
1.3

**SECTION C**  
1.3

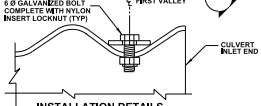

**CULVERT IDENTIFICATION TAG**  
1.3

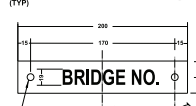

**CULVERT PLAQUE**  
1.3

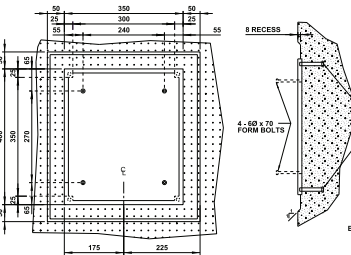

**INSTALLATION DETAILS**  
**LARGE PLAQUE**  
1.3

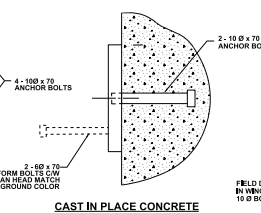

**CAST IN PLACE CONCRETE**  
1.3

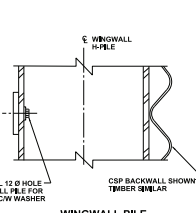

**WINGWALL PILE**  
1.3

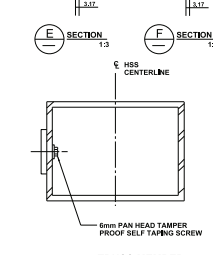

**TRUSS MEMBER**  
1.3

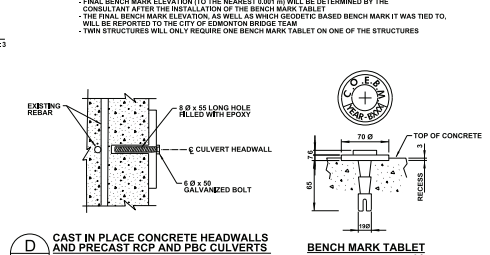

**CAST IN PLACE CONCRETE HEADWALLS AND PRECAST RCP AND PVC CULVERTS**  
(CSP SHOWN, PRECAST SIMILAR) 1.3

**BENCH MARK TABLET**  
1.3

**GENERAL NOTES:**

- ALL DIMENSIONS ARE IN MILLIMETERS UNLESS NOTED
- LARGE PLAQUE SHALL BE USED FOR VERTICAL BRIDGES, BRIDGE SIZE CULVERTS AND MAJOR PEDESTRIAN BRIDGES
- SMALL PLAQUE SHALL BE USED FOR STANDARD BRIDGES, CULVERTS, AND PEDESTRIAN TRUSS BRIDGES
- CULVERT PLAQUE SHALL BE USED FOR METAL CULVERTS
- FABRICATION AND INSTALLATION OF ALL PLAQUES AND BENCH MARK TABLETS FOR ALL THE NEW STRUCTURES SHALL BE IN ACCORDANCE WITH AT STANDARD SPECIFICATIONS FOR BRIDGE CONSTRUCTION SECTION 13
- MATERIALS FOR ALL PLAQUES SHALL BE CAST ALUMINUM

**PLAQUES:**

- ALL PLAQUES SHALL BE FABRICATED TO THE DIMENSIONS SHOWN. ANY PROPOSED CHANGES SHALL BE APPROVED BY THE CITY OF EDMONTON
- BRIDGE PLAQUES SHALL BE LOCATED ON THE RIGHT HAND SIDE OF THE FIRST ABUTMENT ENCOUNTERED IN THE DIRECTION OF TRAVEL
- FOR CIP HEADWALLS AND PRECAST CONCRETE CULVERTS THE PLAQUE SHALL BE LOCATED AT THE INLET END
- ALL LETTERS AND NUMBERS CAST ON THE PLAQUE SHALL BE UPPERCASE UNIVERS 65, EXCEPT NAME "EDMONTON"
- NAME "EDMONTON" SHALL BE FOLLOWED BY ABSOLUTE DETAILS AS SHOWN IN THE PRELO SEMIBOLD FONT. ANY DEVIATIONS REQUIRED FOR CASTING PURPOSES SHALL BE REVIEWED AND ACCEPTED BY THE CITY OF EDMONTON
- BRIDGE NAME CAST ON THE PLAQUES @ SITE SPECIFIC AND SHALL BE PROVIDED BY THE CITY OF EDMONTON
- THE BRIDGE NAME SHALL BE PLACED IN 2 OR 3 LINES AS REQUIRED
- THE YEAR SHALL BE THE YEAR WHEN CONSTRUCTION IS COMPLETED
- BRIDGE NUMBER SHALL BE OBTAINED FROM THE CITY OF EDMONTON
- ALL PLAQUES SHALL BE SUPPLIED WITH BLACK ALUMINUM PAINT EVERYWHERE EXCEPT FOR FULL BORDERS AND ALL NUMBERS AND LETTERS WHICH SHALL BE EXPOSED ALUMINUM WITH 2 LAYERS OF CLEAR COAT AND
- HEX HEAD CAP SCREWS SHALL CONFORM TO ASTM A307. NUTS AND WASHERS SHALL CONFORM TO ASTM A550 AND A563 RESPECTIVELY
- BOLTS, NUTS AND WASHERS SHALL BE GALVANIZED IN ACCORDANCE WITH ASTM F2329
- FILL NUTS THAT RECEIVE FORM BOLTS WITH EPOXY

**BENCH MARK TABLETS**

- BRIDGE BENCH MARK TABLETS SHALL BE INSTALLED ON MAJOR AND STANDARD BRIDGE STRUCTURES
- THE SUPPLY, FABRICATION AND INSTALLATION OF BENCH MARK TABLETS SHALL BE IN ACCORDANCE WITH CURRENT ALBERTA TRANSPORTATION STANDARD SPECIFICATIONS FOR BRIDGE CONSTRUCTION SECTION 13
- BENCH MARK TABLETS SHALL BE INSTALLED ON ABUTMENTS THAT ARE SUPPORTED ON PILES OR BERTHOCS
- BENCH MARK TABLETS SHALL GENERALLY BE PLACED ON THE NORTH WEST CORNER OF THE ABUTMENT AND THE LOCATION OF THE BENCH MARK TABLETS SHALL BE CLEARLY MARKED ON THE SITE SPECIFIC DRAWINGS
- THE FINAL BENCH MARK ELEVATION, AS WELL AS WHICH GEODETIC BASED BENCH MARK IT WAS TIED TO, WILL BE REPORTED TO THE CITY OF EDMONTON BRIDGE TEAM
- TWIN STRUCTURES WILL ONLY REQUIRE ONE BENCH MARK TABLET ON ONE OF THE STRUCTURES

<b>Edmonton</b>			
<b>BRIDGE/CULVERT STANDARD IDENTIFICATION PLAQUES AND BENCHMARK TABLETS</b>			
DATE APPROVED: <b>2023</b>	DESIGNED BY: <b>CJC</b>	REVISED BY: <b>MS</b>	PROJECT NUMBER: <b>6525</b>
STANDARD DRAWING	SCALE: <b>N.T.S.</b>	CREATED BY: <b>MS</b>	DATE: <b>2023-08-31</b>

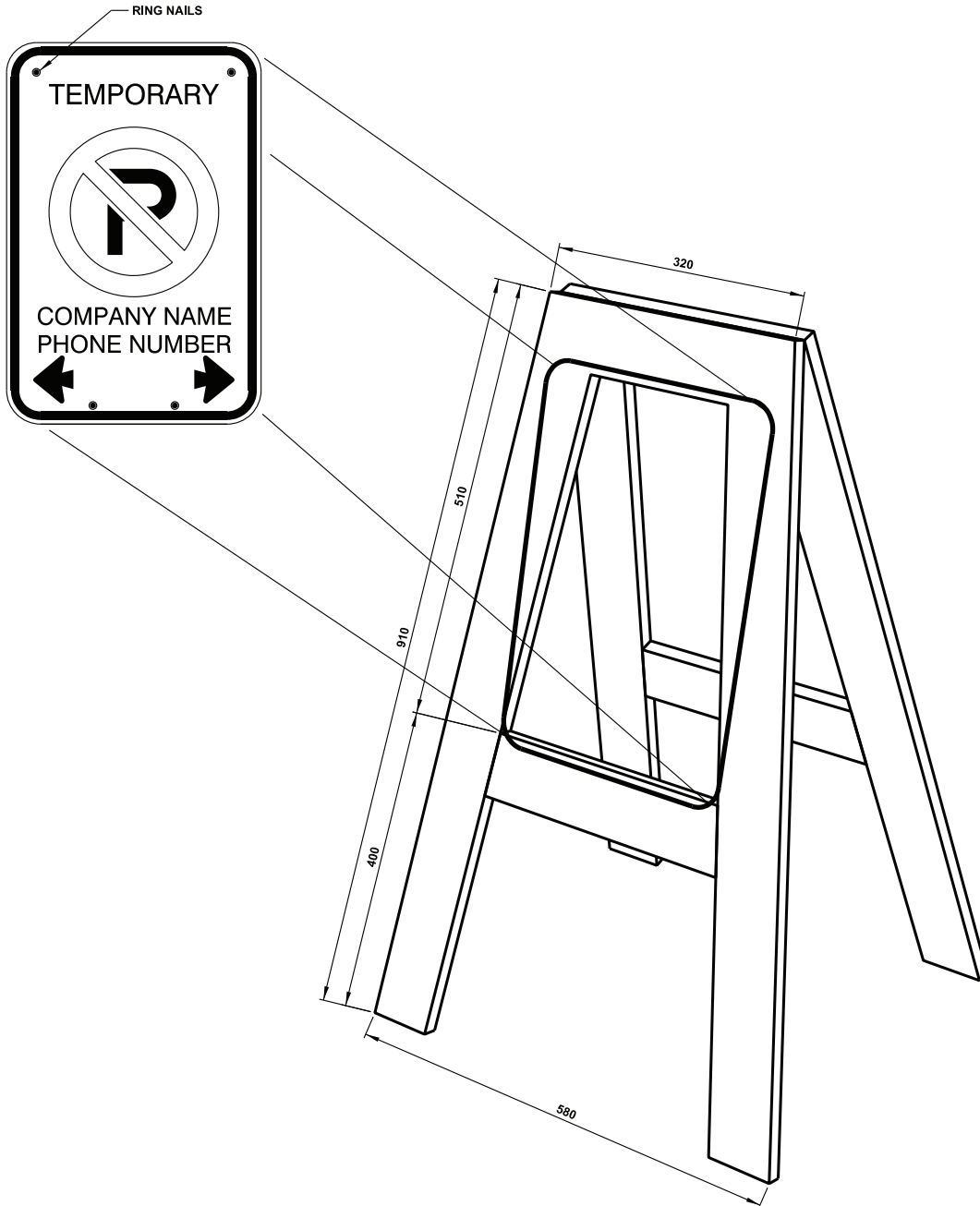

**NOTES:**

1. SIGN: 30cm x 45cm BLACK MESSAGE  
 BORDER: RED CIRCLE AND WHITE BACKGROUND. (RB-5203)
2. PLACE AT 45° FACING TRAFFIC.  
 SPACING @ 25.00m (MAX.)

**ALL DIMENSIONS  
 IN MILLIMETRES UNLESS  
 OTHERWISE NOTED**

**TYPICAL A-FRAME SIGN**



STANDARD DRAWING

2023-08-31

DATE APPROVED: **2018**

SCALE: **N.T.S.**

DRAWN BY: **KSYC**

CHECKED BY: **JN**

APPROVED: *M.A.R.*

DRAWING NUMBER:

**6530**

v05

Page 668

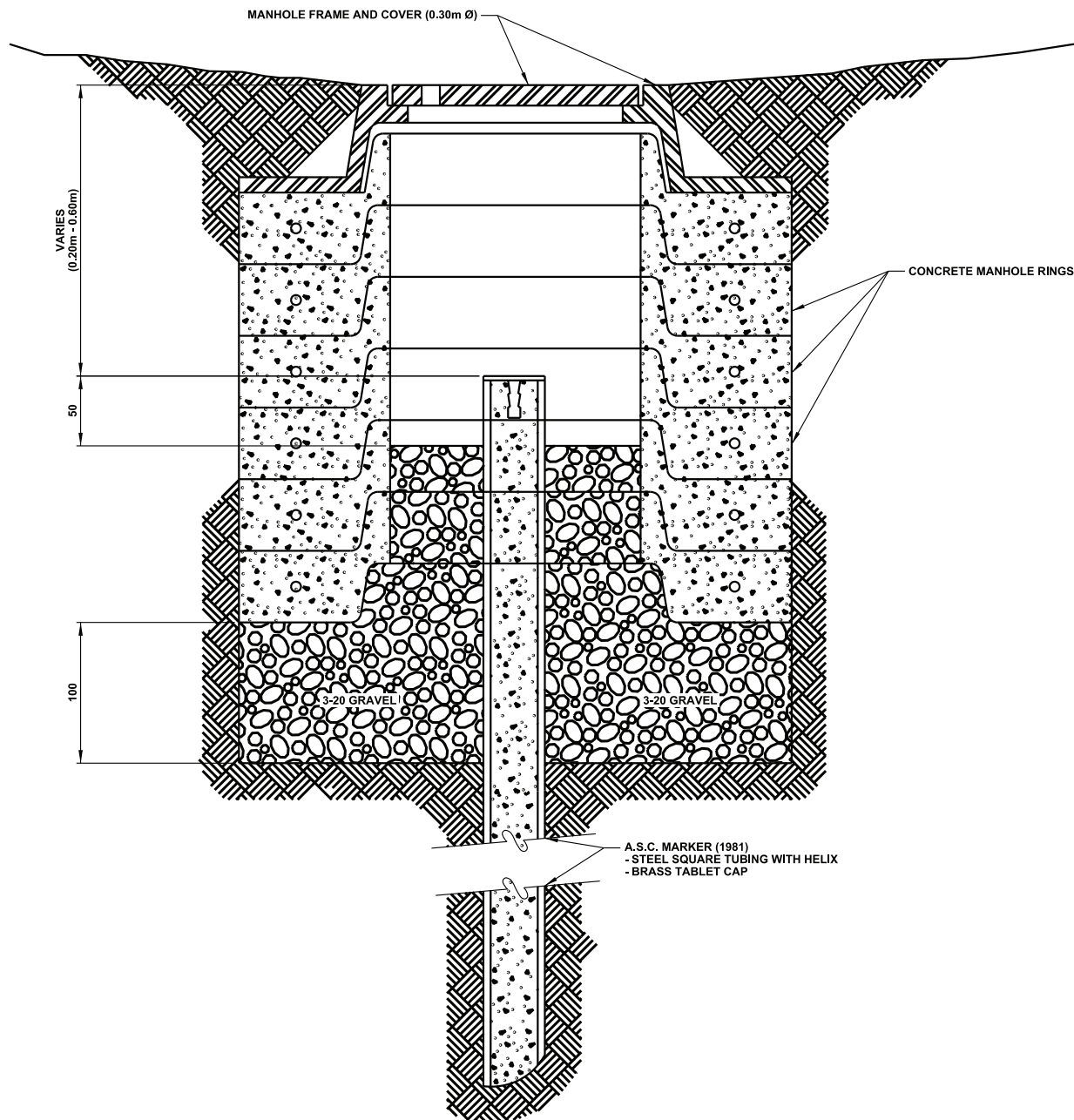

NOTES:

1. NUMBER OF CONCRETE RINGS (MINIMUM 4 RINGS) VARIES WITH DEPTH.

ALL DIMENSIONS  
IN MILLIMETRES UNLESS  
OTHERWISE NOTED



STANDARD DRAWING

2023-08-31

MANHOLE INSTALLATION FOR SURVEY CONTROL MARKERS  
DEPTHS BETWEEN 0.20m - 0.60m

DATE APPROVED: 2018

DRAWN BY: KSYC

APPROVED: *M.R.*

DRAWING NUMBER: 6600

SCALE: N.T.S.

CHECKED BY: JN

v05

Page 669

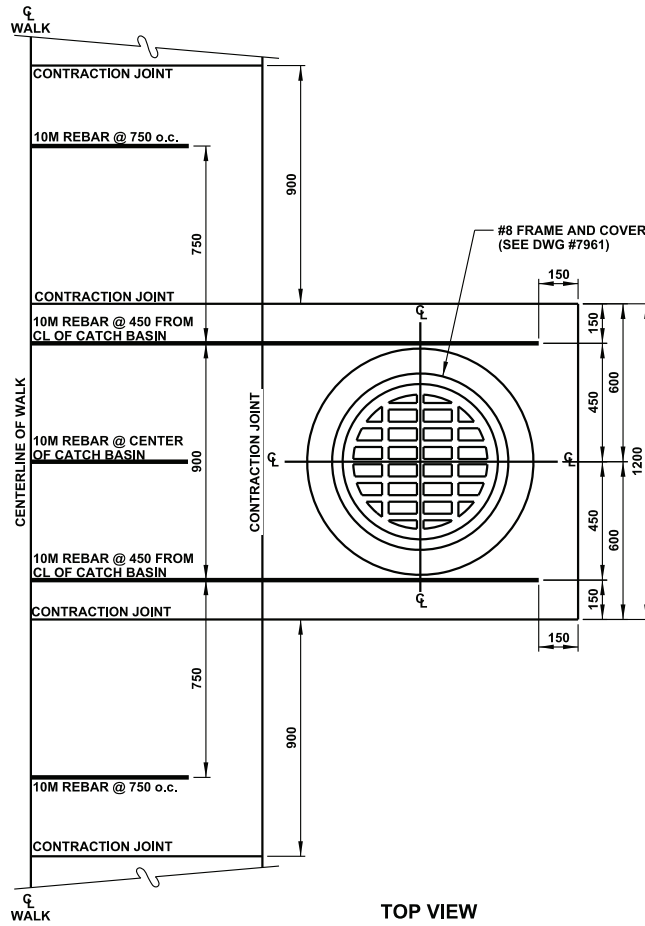

TOP VIEW

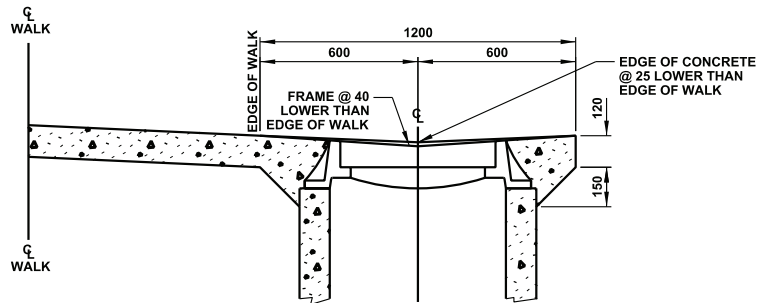

CROSS-SECTION VIEW

**ALL DIMENSIONS  
IN MILLIMETRES UNLESS  
OTHERWISE NOTED**



STANDARD DRAWING

2023-08-31

**CATCH BASINS IN WALKWAY RIGHT-OF-WAY**

DATE APPROVED: **2018**

SCALE: **N.T.S.**

DRAWN BY: **KSYC**

CHECKED BY: **JN**

APPROVED: *M.A.R.*

DRAWING NUMBER:

**7976**

v05

Page 670

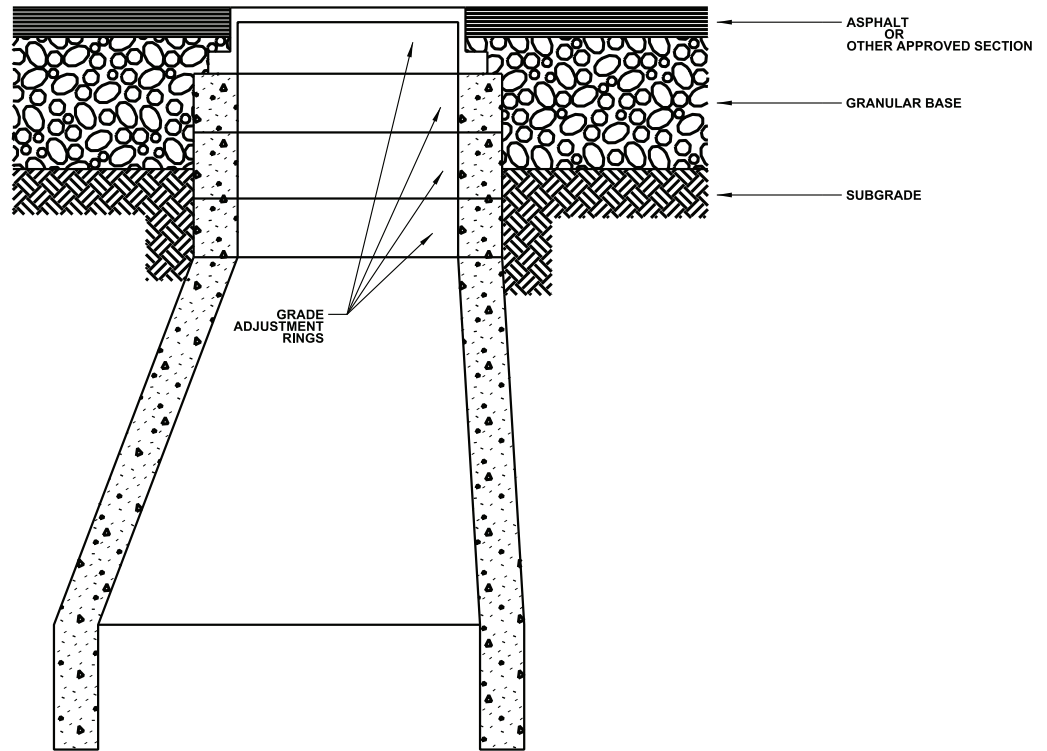

MANHOLE DETAIL

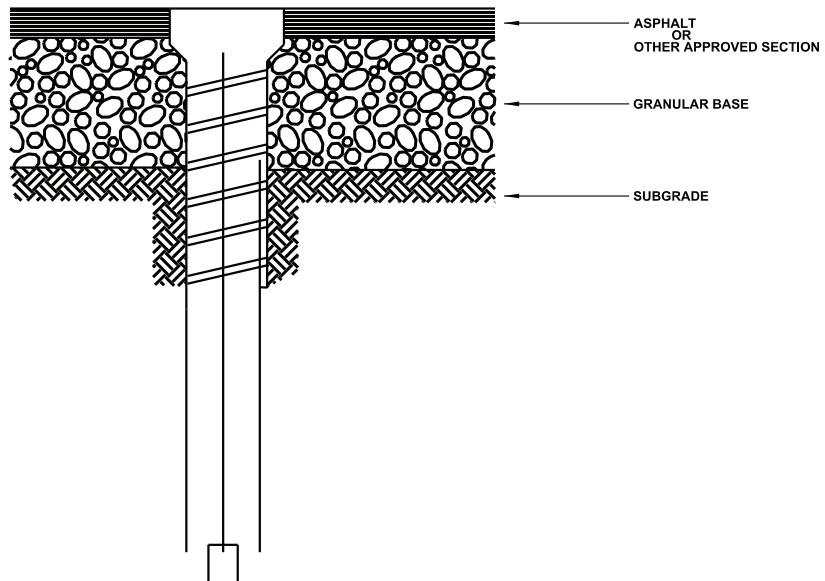

VALVE DETAIL

NOTES:

- 1 THIS DETAIL APPLIES TO BACKFILL FOR MANHOLE AND VALVE RAISED TO FINISHED SUBGRADE, FINISHED GRAVEL GRADE, AND FINISHED ASPHALT GRADE IN SUCCESSIVE OPERATIONS.
- 2 BACKFILL WITH EXISTING MATERIALS (CLAY OR GRANULAR BASE) WHEN MANHOLE FRAMES AND COVERS ARE RAISED FROM BELOW SUBGRADE TO TOP OF SUCCESSIVE LAYER (SEVERAL OPERATIONS). IF NOT, REFER TO DWG #7981.



STANDARD DRAWING

2023-08-31

BACKFILL DETAIL  
OF  
MANHOLE AND VALVE RAISED TO GRADE

DATE APPROVED: 2018

SCALE: N.T.S.

DRAWN BY: KSYC

CHECKED BY: JN

APPROVED: *M.A.R.*

DRAWING NUMBER:

7980

v05

Page 671

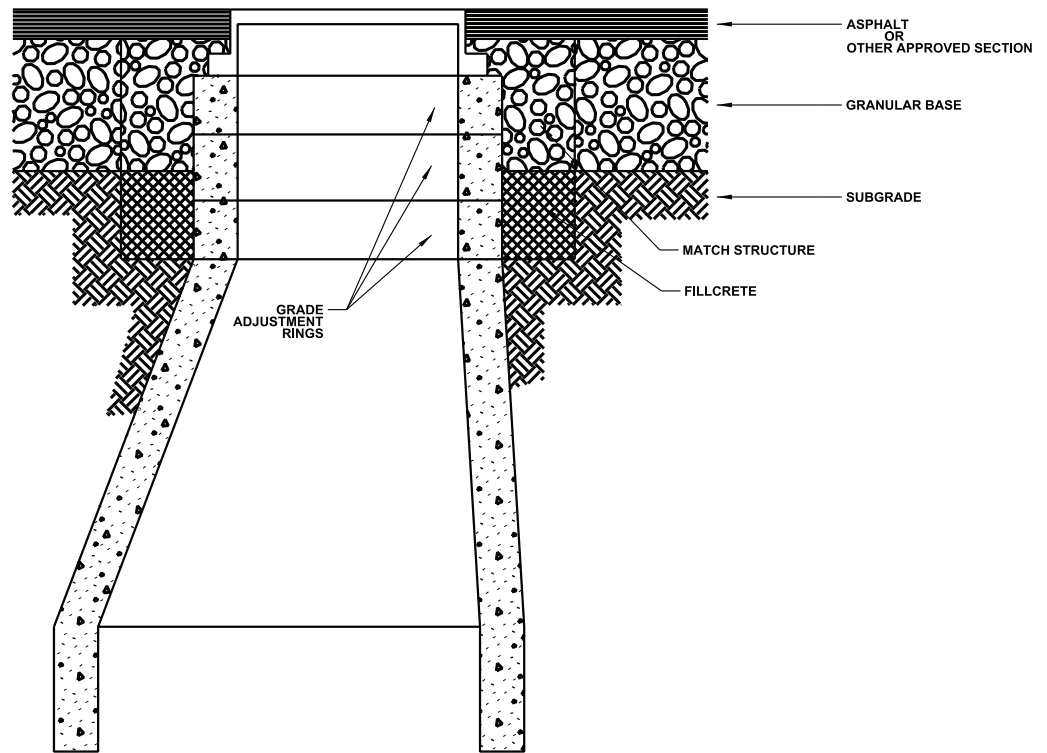

MANHOLE DETAIL

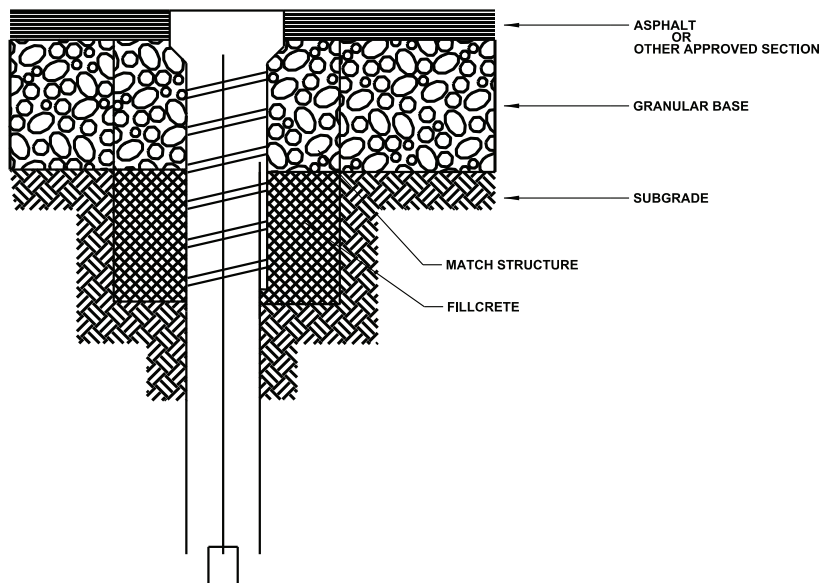

VALVE DETAIL

NOTES:

1. BACKFILL WITH FILLCRETE WHEN MANHOLE FRAMES AND COVERS ARE RAISED FROM BELOW SUBGRADE TO UNDERSIDE OF GRANULAR BASE.
2. SDR3T PVC SLEEVE TO BE PLACED AROUND VALVE CASING WHEN IN FILLCRETE.



STANDARD DRAWING

2023-08-31

BACKFILL DETAIL OF MANHOLE AND VALVE RAISED TO GRADE (FILLCRETE OPTION)

DATE APPROVED: 2018

DRAWN BY: KSYC

APPROVED: *M.A.R.*

DRAWING NUMBER: 7981

SCALE: N.T.S.

CHECKED BY: JN

v05

Page 672



