

Development Services,
Urban Planning and Economy

Edmonton

**Low Impact Development
(LID) Guidelines For Corner
Lot Infill Developments**

COE-IM-GUIDE-0036

Version 01
Date: 2024-05-07



Preamble

The impetus for this work comes from the Infill Roadmap 2018 through Action 12 (Reduce barriers to Low Impact Development in low and medium scale infill). Analysis of the barriers identified the need for:

- Clear regulations
- Clear processes
- Where possible, to simplify the design of these systems, and
- Increased awareness

While small infill sites present significant challenges, the relative consistency of corner lot 3 or 4 unit infill developments presented opportunities for a pre-approved Low Impact Development (LID) design to increase their ease-of-use and speed up the approval process. These design parameters were developed to maximize the benefits of the LID facility to reduce peak runoff, while minimizing the relative size and impact on the overall lot. This eliminates the need for the developer to calculate the exact volume of water by manipulating the size and depths of the facilities to reduce costs and time needed for design, review and approval. They provide significant guidance on design, installation, and plant selection, while still providing some flexibility to accommodate site specific needs. These designs were also developed to work with minimal changes to the existing process for lot grading, landscaping and onsite storage designs already required as part of a multifamily development.

Disclaimer

The LID Guidelines for Corner Lot Infill Developments (the LID Guidelines) have been provided for general information purposes only and any reliance that you place on these Infill LID Guidelines is strictly at your own risk.

Compliance with these Infill LID Guidelines will result in approval of your LID design by the City of Edmonton; however, connection to utility services will remain subject to approval by EPCOR. You are solely responsible for ensuring that all designs and/or drawings for your project are accurate, complete and compliant with any and all applicable laws, codes and guidelines in addition to compliance with these Infill LID Guidelines.

The City of Edmonton and EPCOR are not responsible for, and disclaim any and all liability related to the use of these Infill LID Guidelines.

If all aspects of these Guidelines for corner lot 3 or 4 unit infill developments are met, the standard authentication processes for Lot Grading and Mechanical Servicing Plans will apply. Alternative LID designs will require further authentication and approval processes. LID may be utilized in lieu of traditional underground storm servicing systems. LID facilities that deviate from those outlined in these Guidelines including plant species must be signed and stamped by a qualified professional, such as but not limited to a professional engineer, landscape architect, landscape architecture technologist or agrologist and may be subject to further review.

The information contained in these Infill LID Guidelines is provided for general information purposes only. You are fully responsible for ensuring that your designs and drawings based on these Infill LID Guidelines are accurate, complete and conform to all applicable law, codes, and guidelines.



AUTHENTICATION TABLE

PROFESSIONAL [ENGINEERING | GEOSCIENCE]
AUTHENTICATED BY

PEG RESPONSIBLE MEMBER QA
VALIDATED BY

Syeda Khan, P.Eng
Senior Development Engineer
Planning Coordination, Urban Planning and
Economy

Jatinder Tiwana, P.Eng
Acting Director
Planning Coordination, Urban Planning and
Economy

VER	Date	Revision Summary	Author	Checked	Appv'd
01	2024-05-07	Updated to a new template and added authentication table	AMY LING (EPCOR)	SHAMIM BEGUM	SYEDA KHAN/ JATINDER TIWANA

Printed or downloaded copies of this document are not controlled and may not be the [current version](#).



Table of Contents

1.1 Site Planning Considerations	5
1.2 Design Basis	6
1.3 Rain Garden Design	9
1.4 Bioretention Basin Design	13
1.5 Box Planter Design	18
1.6 Vegetation Selection	22
1.7 LID Drawing Requirements	28
1.8 Erosion and Sedimentation Control Measures (ESC)	30
1.9 Construction Considerations	31
1.10 LID Soil Media Specifications	33

1. LID FACILITY DESIGN FOR CORNER LOT 3 OR 4 UNIT INFILL DEVELOPMENTS

These LID Facility Guidelines for corner lot 3 or 4 unit infill developments are for new developments only. Buildings must meet all applicable laws, codes, and guidelines.

1.1. Site Planning Considerations

Site integration is key to the use of LID facilities. LID facilities must be within the property line and can be integrated into the existing landscape and used to highlight other landscaping features. The following should be considered when siting an LID facility:

- Site drainage patterns and topography
- System orientation and footprint
- Depth to water table
- Storm sewer main availability
- Buffers and setbacks
- Utility conflicts
- Future use of space



A background data review is important before selecting LID types. For infill and redevelopment sites, If geotechnical information is available (from nearby sites or municipal projects) it should be reviewed prior to installation of LID facilities.

The City of Edmonton has a geo-environmental library where records can be [requested](#). If geotechnical information is not available, site data can be collected during foundation excavations to confirm soil types.

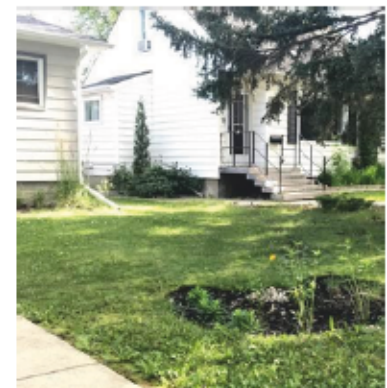

Photos 1 & 2: Both LID facilities pictured were retrofitted and designed to preserve the mature trees shown. Photo 1 also incorporated the LID facility into the existing garden/landscaping feature.



Photo 3: This LID facility was also designed to preserve the mature tree as shown, and the LID facility itself was used as a landscaping facility for the entire development.

1.2. Design Basis

- 1.2.1. LID facilities require surface areas of at least 10% of the lot's impervious surfaces to be effective. The surface areas for garages and dwellings in most corner lot 3 or 4 unit infill developments are typically 300-350 m². This means that LID facilities for these developments would require on-site surface areas of approximately 30-35 m². Two typical layouts are shown in Figures 1 and 2 below. LID facilities larger than this or following a substantially different layout and design must be signed and stamped by a qualified professional.
- 1.2.2. Impervious surface means material that is impenetrable by water and includes building coverage, asphalt, concrete, and brick, stone, and wood that do not have permeable spacing.

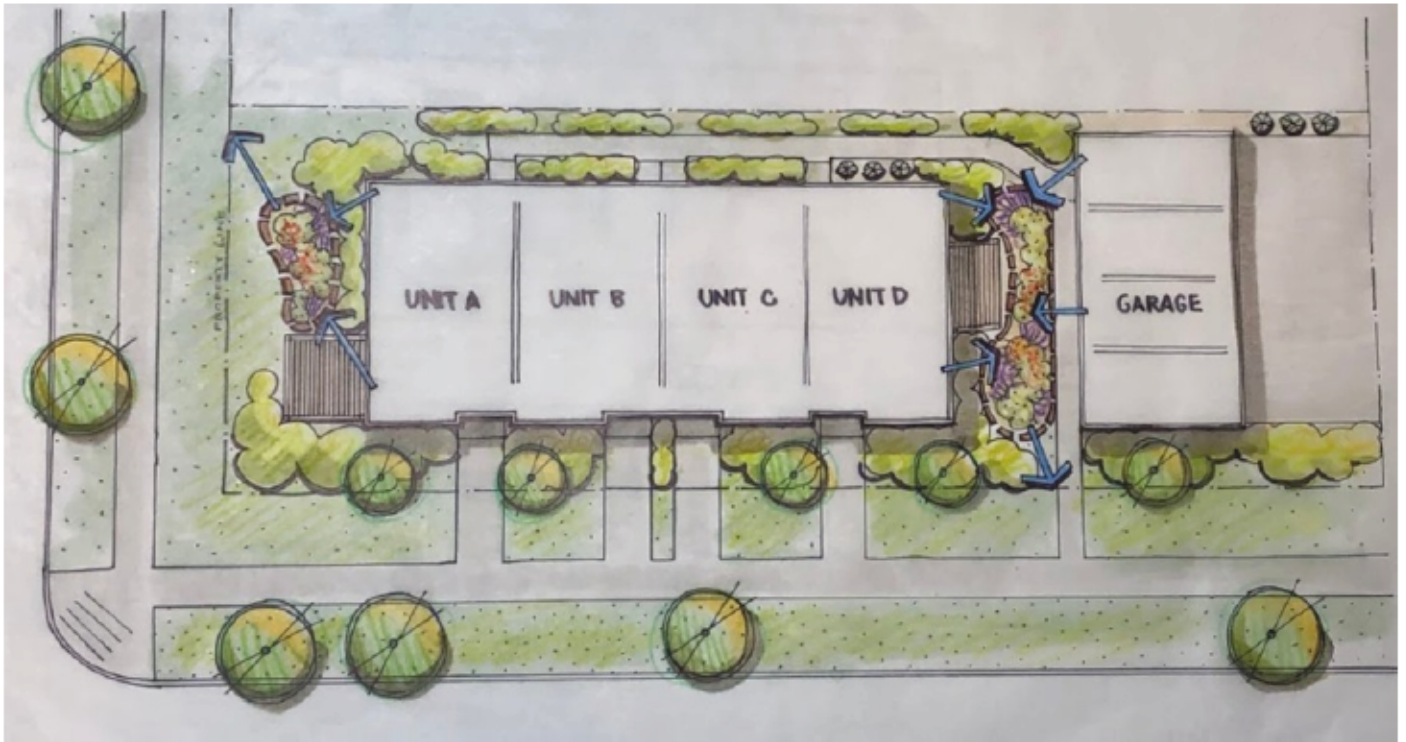

Figure 1: Typical 4- Unit Plan View Layout: Rain Gardens or Bioretention Basins

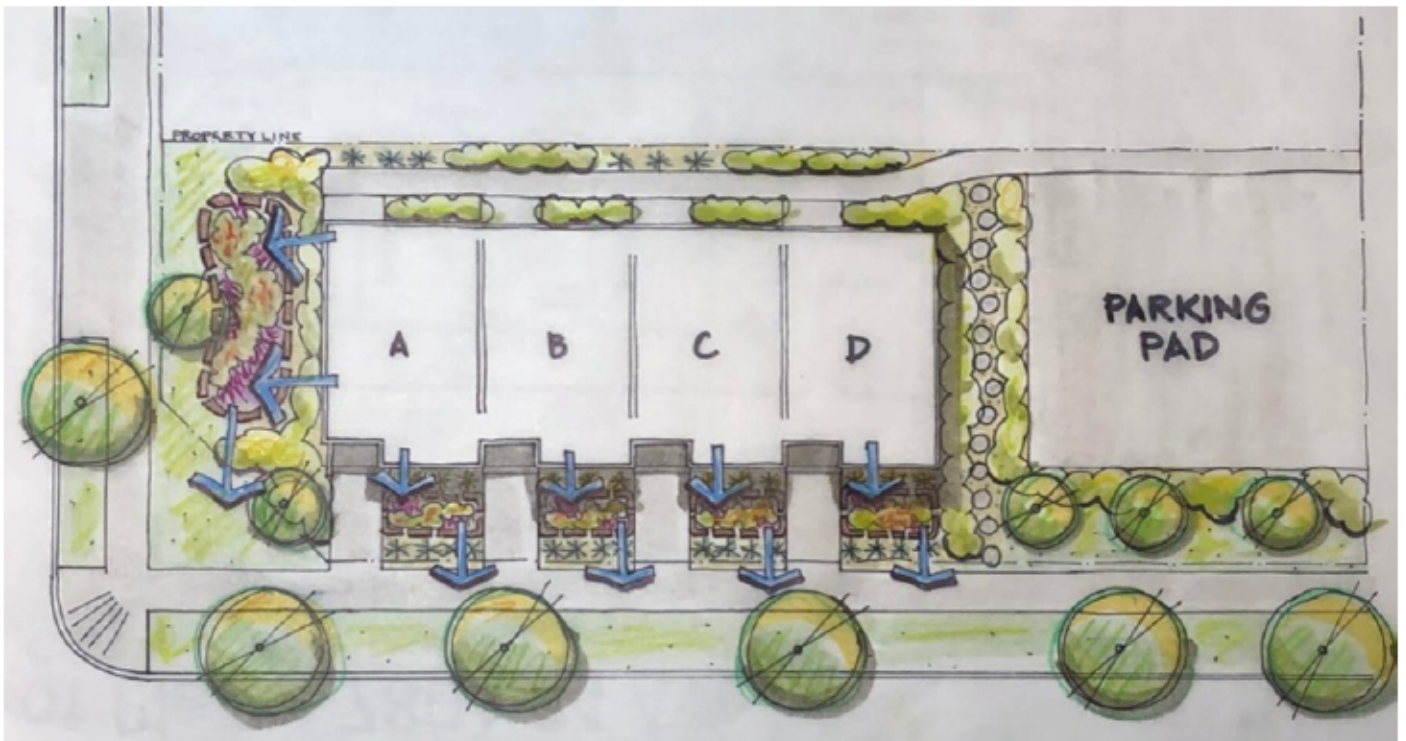

Figure 2: Typical 4-Unit Plan View Layout - Mixed LID Facilities



- 1.2.3. LID facilities must be located at a minimum distance of 50 m from the top of bank.

- 1.2.4. LID facilities must be located a minimum setback of 1.0 m from buildings. An impermeable membrane must be placed within the slopes excavation on the side of the LID adjacent to the foundation or in proximity to a titled lot and must extend at least half-way through the LID facility. Sub-excavation must not extend below the bottom of the basement’s slab and all Alberta Health, Safety and Environment regulations and building codes must be followed. Where this setback and/or these controls are not possible, site specific analysis and a signed and stamped design by a qualified professional is required. If the LID is fully lined with an impermeable membrane, then the infiltration function of the LID is removed and consideration should be given to reduce the surface ponding depth so that water is not ponded longer than desired.
 - 1.2.4.1. Impermeable membranes should be linear low-density polyethylene (LLDPE) 20-mil following the minimum specifications identified in Table 1. Subgrade should be smooth and devoid of rocks, lumps, depressions and others that may affect the liner’s integrity. The membrane should be installed following the manufacturer’s specifications.

Table 1: LLDPE 20-mil Minimum Specifications

Property	Test	Frequency	Unit	Value
Thickness (min. avg.)	ASTM D-5199	Per roll	mm (in)	0.50 (0.01969)
Sheet Density	ASTM D-1505	90,000 kg (200,000 lb)	g/ml	0.939
Carbon Black Content	ASTM D-1603 (3)	20,000 kg (45,000 lb)	%	2.0 - 3.0
Tensile Strength at Break	ASTM D-6693	9,000 kg (20,000 lb)	N/mm (lb/in)	13 (76)
Elongation at Break	ASTM D-6693	9,000 kg (20,000 lb)	%	700
Tear Resistance	ASTM D-1004	20,000 kg (45,000 lb)	N (lb)	50 (11)
Puncture Resistance	ASTM D-4833	20,000 kg (45,000 lb)	N (lb)	124 (28)

- 1.2.5. The bottom of the lowest layer of any LID facility must be at least 1.0 m above the seasonally high groundwater table. Groundwater levels will fluctuate seasonally and in response to climatic conditions so 1.0 m is a recommended guide where data from a detailed assessment is not available.



- 1.2.5.1. If excavation of the building foundation is completed in the spring or summer and no groundwater is encountered, it can be assumed that groundwater is sufficient distance away to allow construction of the LID facility.
- 1.2.5.2. If excavation of the building foundation is completed in the fall or winter and no other geotechnical information is available or if groundwater is encountered during foundation excavation in the spring or summer an impermeable membrane must also be installed along the bottom and around the entirety of the excavation.
- 1.2.5.3. The developer and/or their representative must sign off (either via letter or on as-built drawings) that no groundwater was encountered during foundation excavation.
- 1.2.5.4. Adjustments to this buffer distance may be considered if a signed and stamped design by a qualified professional has been completed. The signed and stamped design must consider potential lift of the underdrain system (if required), and must use controls that limit/stop the movement of groundwater into the LID system.

1.3. Rain Garden Design

1.3.1. Definition

Rain gardens are stormwater management and treatment facilities within a shallow depression. On the surface, rain gardens may appear similar to flower / shrub beds, however they utilize the specified LID Soil Media (Section 1.12) and vegetation to capture and treat rainwater and are located at the low point of a landscape. Rain gardens have no underdrain therefore they consist of an inlet, ponding area, plant materials, and soil media.



1.3.2. Sizing Requirements

- i. Ponding depth within the rain garden is 150 mm- 200 mm.

1.3.3. Surface Geometry and Side Slope

- i. Flat bottom, with a recommended minimum length / width ratio of 2:1, as applicable, if a rain garden is irregularly shaped it should be designed to allow water infiltration throughout the rain garden.
- ii. The preferred side slope of the rain garden is 4:1 (Horizontal:Vertical).

1.3.4. Inlet

- i. Roof leaders from the garage and dwelling must directly discharge into the LID facility or must discharge into a grassed area and flow into the rain garden. Erosion control and energy dissipation such as a rocked inlet, or splash pad is recommended. Roof leaders can also be buried and come to surface within the mulched, vegetated area of the LID facility.

1.3.5. Outlet

- i. An outlet that drains towards a shared drainage pathway (such as a shared swale) or towards the public right-of-way must be provided. Erosion control and energy dissipation such as a rocked outlet or splash pad is required. Outlet flows must be directed away from buildings on the property.



Photo 4: Roof Leader to Splash Pad Inlet



Photo 5: Rocked Outlet



1.3.6. Media Layers

- i. Mulch is optional however if mulch is to be used it shall be long, fibrous non-floatable organic mulch such as a cedar mulch. The depth of the mulch during establishment of vegetation should be 80 mm. A compostable netting may be used to stabilize mulch during establishment of vegetation.
- ii. The LID growing soil media shall meet the specifications in Section 1.12. The depth shall be 550-650 mm and 75% standard proctor density.

1.3.7. Non-woven Geotextile

- i. Non-woven geotextiles are NOT recommended within LID facilities. If geotextile is used for filtration or sidewall coverage, it should be woven monofilament or non-woven needle punched fabrics. Woven slit film and non-woven heat bonded fabrics should not be used as they are prone to clogging. Geotextile fabric may be placed along the sides of the LID facilities to help direct the water flow downward and to reduce lateral flows if sand seams exist.
- ii. If geotextile must be used within the LID to control transport of sediments, the permeability rate should be higher than that of the soil or $3 \text{ m}^3/\text{min}/\text{m}^2$ (75 gal/min/ft²), whichever is greater.

1.3.8. Buffers

- i. The facility base must be 1.0 m above the seasonally high groundwater table (see Section 1.2.4 for additional details).
- ii. Horizontal buffers are 1.0 m from building foundations, with the use of engineering controls as per Section 1.2.3.
- iii. LID facilities must be at least 150 mm from any neighbouring property line.

The profile in Figure 3 shows a typical rain garden layout, and is for illustrative purposes only, it does not depict every detail that may be required for successful design and construction of the LID facility.

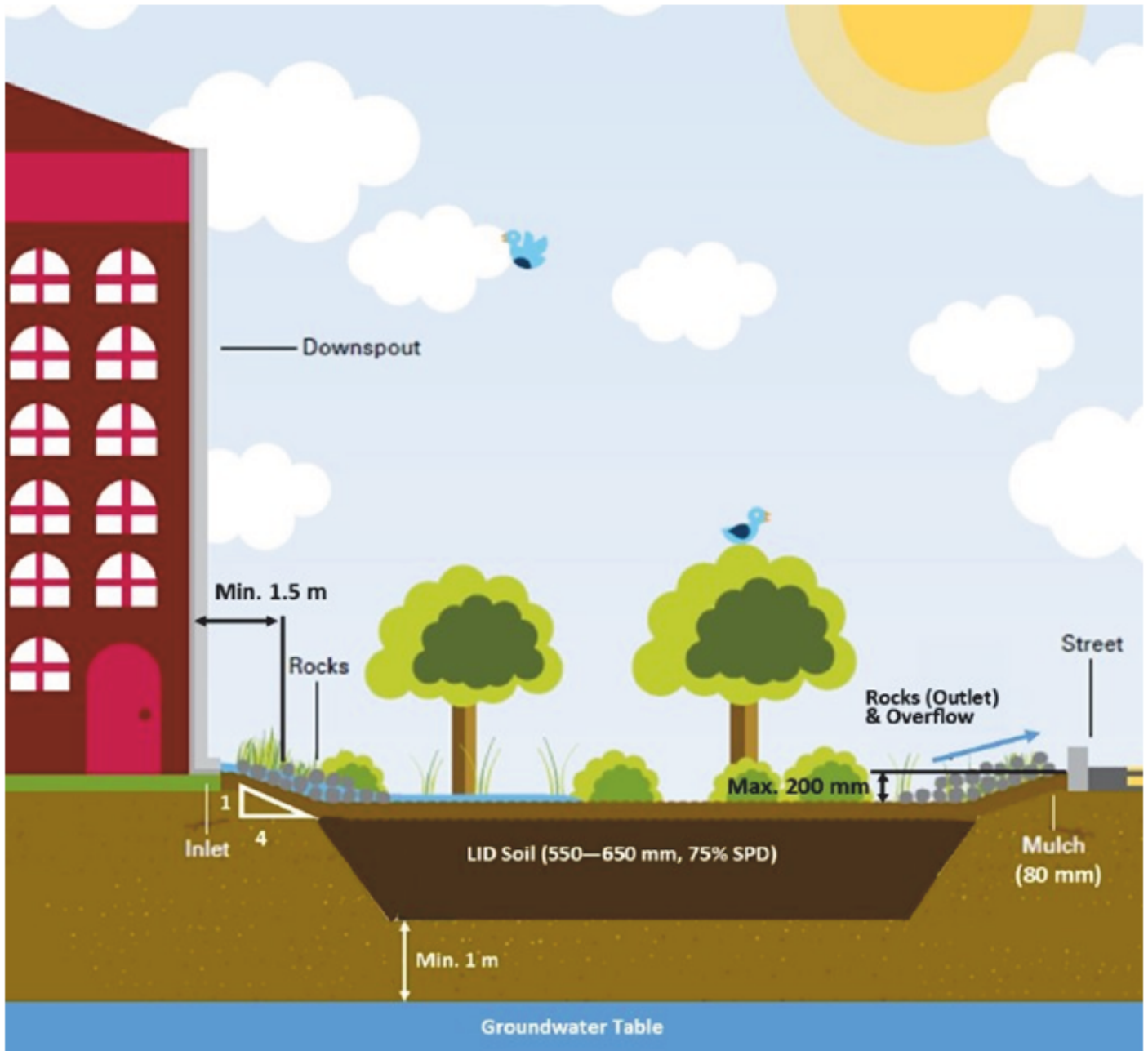
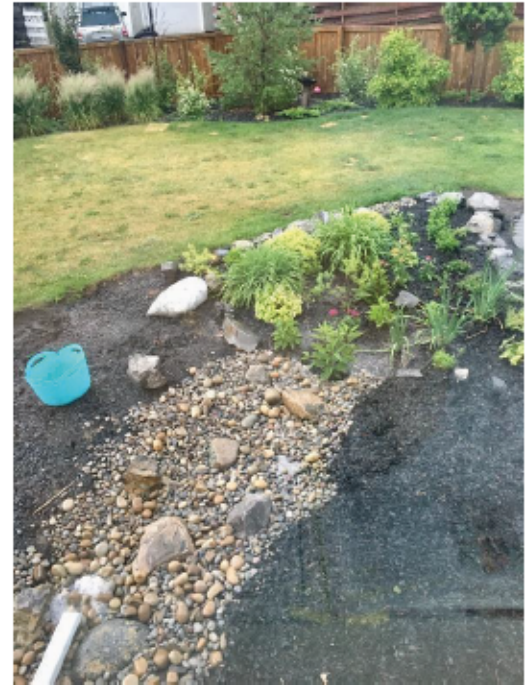

Figure 3: Rain Garden Profile

1.4. Bioretention Basin Design

1.4.1. Definition

Bioretention basins are similar to rain gardens, except that they contain an underdrain; so must be installed in an area with a stormwater service connection. A bioretention basin is a stormwater management and treatment facility typically within a depression area. On the surface, bioretention gardens may appear similar to flower / Shrub beds; however they rely on vegetation, specialized soil media and a storage layer to infiltrate, filter, detain, and retain stormwater runoff. Bioretention basins consist of pretreatment, flow entrance/inlet, ponding area, plant materials, LID soil media, filter layer, storage layer, underdrain, and overflow outlet.



1.4.2. Sizing Requirements

- i. Ponding depth within the bioretention garden is 200-350 mm.

1.4.3. Surface Geometry and Side Slope

- i. Flat bottom, with a recommended minimum length / width ratio of 2:1 as applicable, if a bioretention basin is irregularly shaped it should be designed to allow water infiltration throughout the bioretention basin.
- ii. The preferred side slope of the bioretention basin is 4:1 (Horizontal:Vertical); the maximum allowable side slope is 3:1.

1.4.4. Inlet

- i. Roof leaders from the garage and dwelling must directly discharge into the LID facility or must discharge into a grassed area and flow into the bioretention basin. Erosion control and energy dissipation such as a rocked inlet, or splash pad is recommended. Roof leaders can also be

buried and come to surface within the mulched, vegetated area of the LID facility.

1.4.5. Overland Overflow Outlet

- i. An overflow outlet that drains towards a shared drainage pathway (such as a shared swale) or towards the public right-of-way must be provided. Overflow outlet flows must be directed away from buildings on the property.
- ii. Overflow outlets could be a solid pipe to surface, a catch basin with an overflow, a gravel chimney within the LID facility, or any other piece of infrastructure that allows water from the underdrain to surcharge to surface. Erosion control and energy dissipation may be required around the overflow outlet.

1.4.6. Media Layers

- i. Mulch is optional however if mulch is to be used it shall be long, fibrous non-floatable organic mulch such as a cedar mulch. The depth of the mulch during establishment should be 80 mm. A compostable netting may be used to stabilize mulch during establishment of vegetation.
- ii. The LID growing soil media shall meet the specifications in Section 1.12. The depth shall be 400 mm.
- iii. The filter layer is 100 mm depth with washed rock that is less than 13 mm and less than 0.1% silt. If used, the granular filter layer around the facility should have a minimum thickness of 100 mm with washed rock that is less than 13 mm diameter and less than 0.1% silt. Where situations permit, a greater depth may be applied.
- iv. The drainage layer is 350 mm in depth with 25 mm - 40 mm angular crushed rock containing less than 0.1% silt.

1.4.7. Non-woven Geotextile

- i. Non-woven geotextiles are NOT recommended within LID facilities; if space and design allow, using granular filter layers (See Section 1.3.6) to limit sediment transport is preferred.
- ii. If geotextile is used for filtration or sidewall coverage, it should be woven monofilament or non-woven needle punched fabrics. Woven slit film and non-woven heat bonded fabrics should not be used as they are prone to

clogging. Geotextile fabric may be placed along the sides of the LID facilities to help direct the water flow downward and to reduce lateral flows if sand seams exist.

- iii. If geotextile must be used within the LID to control transport of sediments, the permeability rate should be higher than that of the soil or $3 \text{ m}^3/\text{min}/\text{m}^2$ ($75 \text{ gal}/\text{min}/\text{ft}^2$), whichever is greater.

1.4.8. Underdrain Perforated Pipe

- i. Bioretention basins must contain an underdrain. Underdrains shall be smooth, rigid, PVC perforated pipe (as shown in Figure 4) to allow water from the bioretention basin to flow into the storm sewer system.
- ii. Underdrain piping must sit within and at the bottom of the drainage layer.
- iii. A storm sewer connection following all guidelines must be provided for a bioretention basin.
- iv. Bioretention basins shall not be connected to combined sewer systems.

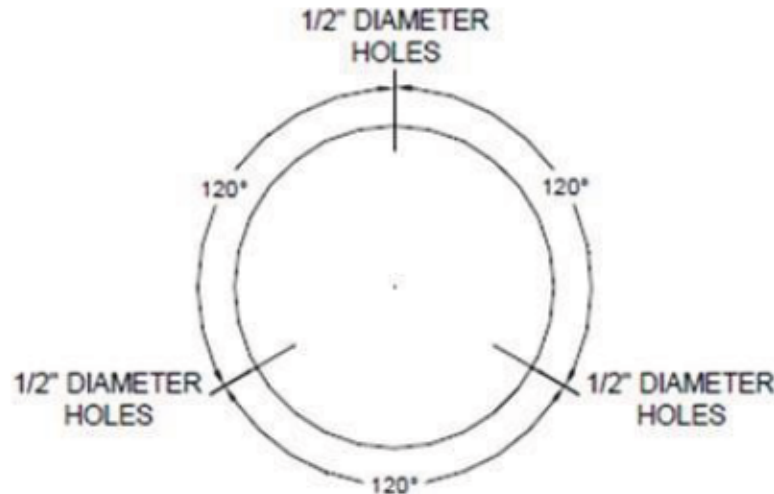

Figure 4: Recommended Pipe Perforations



Photo 6: Perforated PVC Piping

1.4.9. Buffer

- i. The facility base must be 1.0 m above the seasonally high groundwater table (see Section 1.2.4 for additional details).
- ii. Horizontal buffers are 1.0 m from building foundations, with the use of engineering controls as per Section 1.2.3.
- iii. LID facilities must be at least 150 mm from any neighboring property line.

Figure 5 shows profile views of a typical bioretention basin layout, and are for illustrative purposes only, they do not depict every detail that may be required for successful construction, operations, and maintenance.

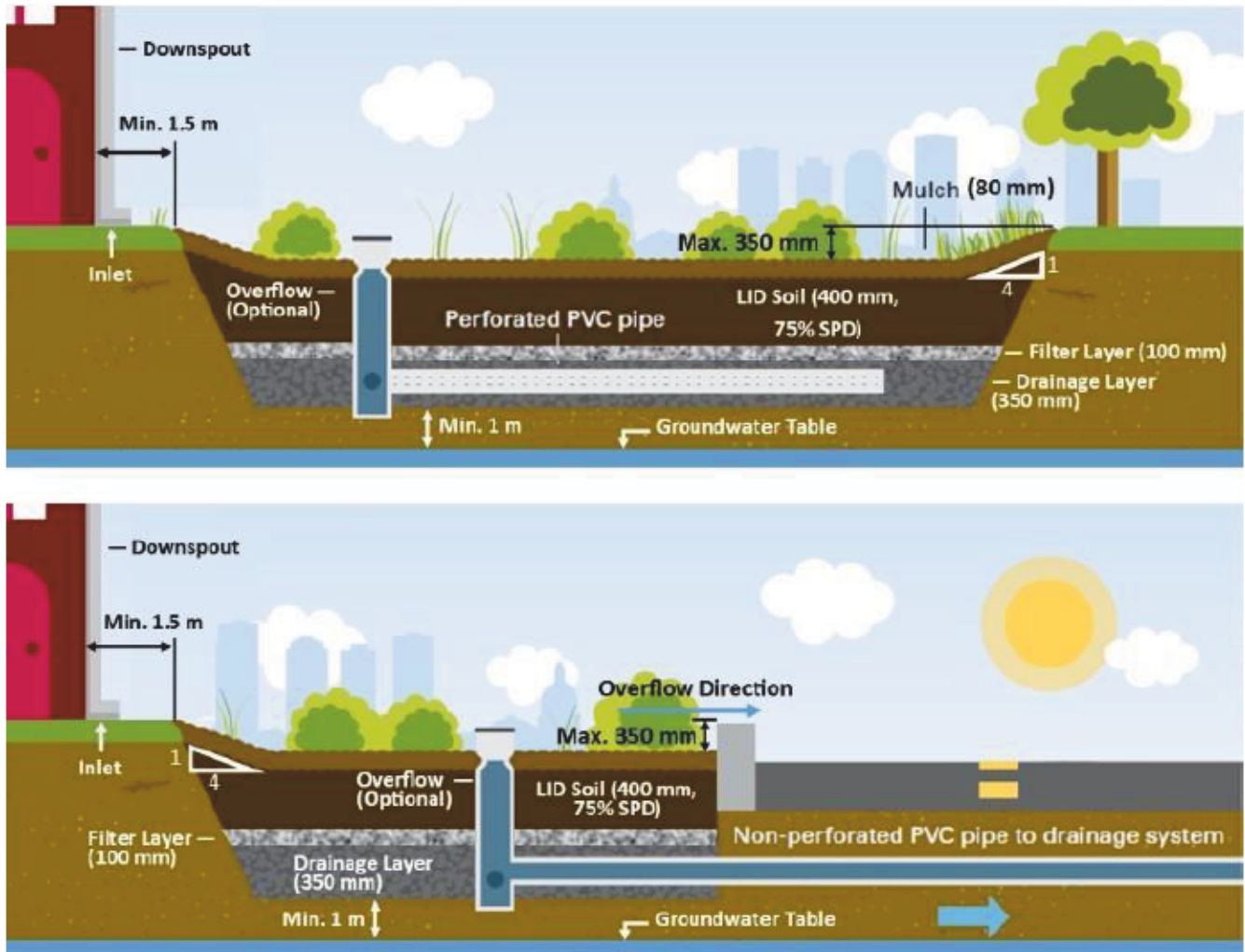

Figure 5: Bioretention Basin Profile

1.5. Box Planter Design

1.5.1. Definition

Similar to bioretention basins, box planters use vegetation and specialized soil media to filter and retain stormwater; however box planters are contained within a box-like structure. Box planters are ideal for areas with small footprints and can be located close to buildings. Box planters can be raised or located flush with/below ground. Box planters may contain an underdrain pipe but should not be connected to combined sewers; if no underdrain pipe is present a surface outlet must be provided.



1.5.2. Sizing Requirements

- i. Ponding depth is a maximum of 350 mm.

1.5.3. Planter Material

- i. Stone, concrete, brick, clay, or plastic are acceptable materials for the contained planters.

1.5.4. Surface Geometry and Surface Slopes

- i. The width of the box planter must be greater than or equal to 450 mm.
- ii. Surface slopes less than 0.5%.

1.5.5. Inlet

- i. Roof leaders from the garage and dwelling must directly discharge into the LID facility. Erosion control and energy dissipation such as a rocked inlet, or splash pad is recommended.

1.5.6. Outlet

- i. An outlet that drains towards a shared drainage pathway (such as a swale) or towards the public right-of-way must be provided. Erosion control and energy dissipation such as a rocked outlet is recommended. Outlet flows must be directed away from buildings on the property.
- ii. If an underdrain is used an overflow outlet must also be provided. The overflow outlet must drain towards a shared drainage pathway (such as a shared swale) or towards the public right-of-way. Overflow outlet flows must be directed away from buildings on the property. Overflow outlets could be a solid pipe to surface, a catch basin with an overflow, a gravel chimney within the LID facility, or any other piece of infrastructure that allows water from the underdrain to surcharge to surface. Erosion control and energy dissipation may be required around the overflow outlet.

1.5.7. Media Layers

- i. Mulch used shall be long, fibrous non-floatable organic mulch such as a cedar mulch. The depth of the mulch during establishment should be 80 mm. A compostable netting may be used to stabilize mulch during establishment of vegetation.
- ii. The LID growing soil media shall meet the specifications in Section 1.12. The depth shall be 400 mm.
- iii. The filter layer is 100 mm depth with washed rock that is less than 13 mm and less than 0.1% silt.
- iv. The drainage layer is a minimum of 350 mm in depth with 25 mm - 40 mm angular crushed rock containing less than 0.1% silt.

1.5.8. Non-woven Geotextile

- i. Non-woven geotextiles are NOT recommended within LID facilities; if space and design allow, using granular filter layers to limit sediment transport is preferred. If used, the granular filter layer around the facility should have a minimum thickness of 100 mm with washed rock that is less than 13 mm diameter and less than 0.1% silt. Where situations permit, a greater depth may be applied.
- ii. If geotextile is used for filtration or sidewall coverage, it should be woven monofilament or non-woven needle punched fabrics. Woven slit film and non-woven heat bonded fabrics should not be used as they are prone to clogging. Geotextile fabric may be placed along the sides of the LID



facilities to help direct the water flow downward and to reduce lateral flows if sand seams exist.

- iii. If geotextile must be used within the LID to control transport of sediments, the permeability rate should be higher than that of the soil or $3 \text{ m}^3/\text{min}/\text{m}^2$ (75 gal/min/ft²), whichever is greater.

1.5.9. Underdrain Perforated Pipe

- i. Box planters may contain an underdrain. Underdrains shall be smooth, rigid, PVC perforated pipe (as shown in Figure 4) to allow water from the box planter to flow into the storm sewer system. If a connection to the sewer system is required an underdrain should be installed.
- ii. Underdrain piping must sit within and at the bottom of the drainage layer.
- iii. If an underdrain is present a storm sewer connection following all guidelines must be provided.
- iv. Box planter underdrains shall not be connected to combined sewer systems.

1.5.10. Buffer

- i. The facility base must be 1 m above the seasonally high groundwater table (see Section 1.2.4 for additional details).
- ii. Horizontal buffers are 1.0 m from building foundations, with the use of engineering controls as per Section 1.2.3. Box planters may be placed adjacent to buildings with engineering controls and as approved by a qualified professional.
- iii. LID facilities must be at least 150 mm from any neighboring property line.

Figure 6 shows a profile view of a typical box planter layout, it is for illustrative purposes only, and does not depict every detail that may be required for successful design and construction.

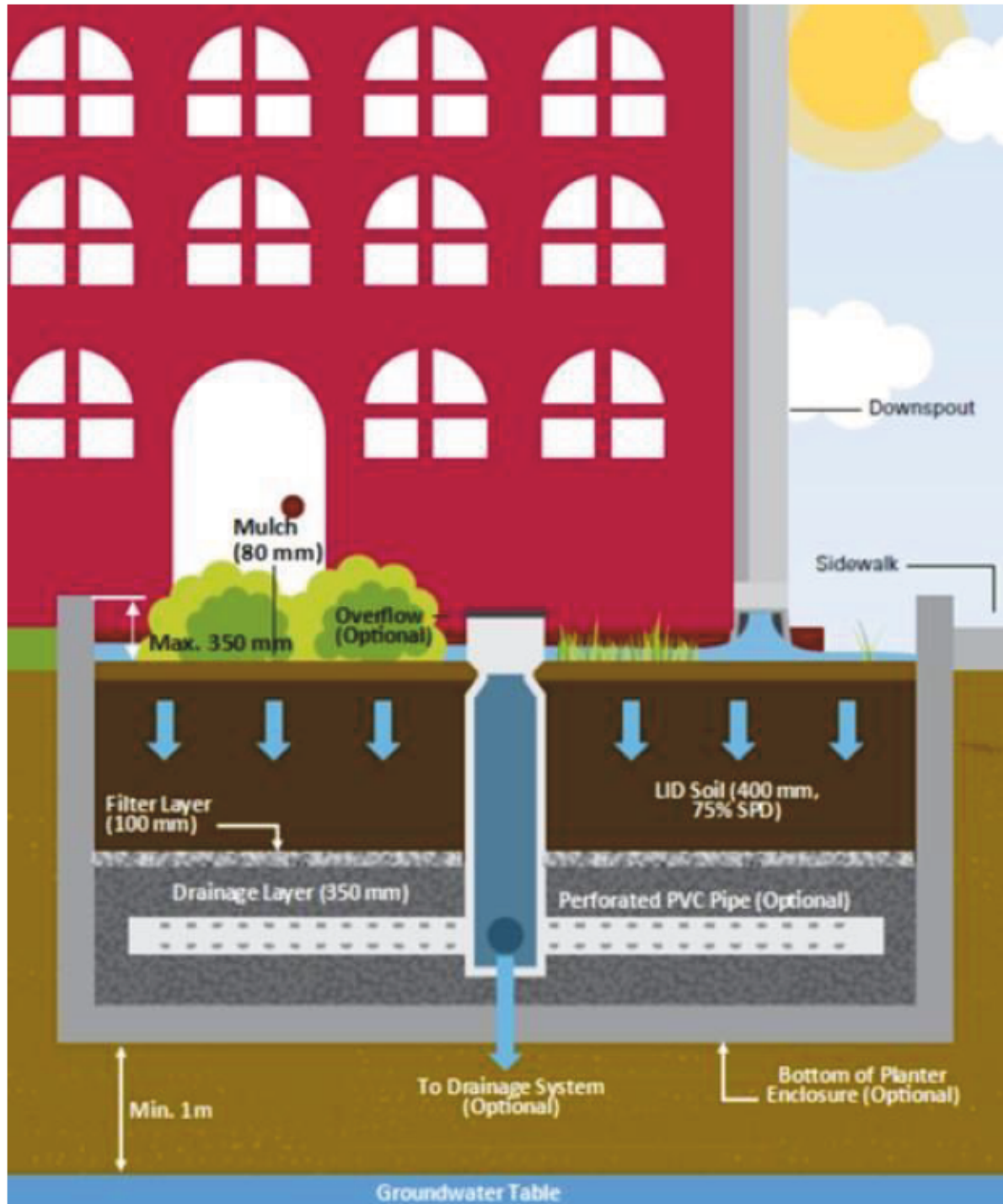

Figure 6: Box Planter Section



1.6. Vegetation Selection

1.6.1. Select plant varieties that will thrive on the site conditions and that grow well together. Species selection should consider:

- Soil permeability and periodic inundation of the soil;
- LID soil media type;
- Tolerance of seasonal salt loadings depending on facility location;
- Pollutant uptake capacity;
- Maintenance needs, including mowing and pruning;
- Reduction of water and fertilizer needs after establishment; and
- Resistance to pests.

Recommended native and ornamental species for LID are listed in Tables 1 and 2 below. The tables below are provided as guidance that outlines some of the characteristics and principles of plant selection that we look for when designing LID facilities. Note all recommended plant species may not be suitable for every situation and may not all work well in a community together.



Table 1: Recommended Native Plant Species for LID Facilities in Edmonton, Alberta

Common Name	Scientific Name	Drought Tolerance	Salt Tolerance	Soil Moisture Tolerance	Mature Spread (cm)	Mature Height (cm)	Sunlight Preference	Additional Information and Maintenance Considerations
Aquatic Plants								
Beaked Sedge	<i>Carex utriculata</i>	Medium	Low	Moist - Wet		50 -100	Full Sun	Spreads by rhizomes to form clumps.
Bulrush	<i>Scirpus spp.</i>	Low	Medium	Moist - Wet		100-200	Part Shade - Full Sun	Full sun to light shade
Forbs								
Small Leaved Pussytoes	<i>Antennaria parvifolia</i>	High	Medium	Dry - Moist	30-50	45580	Full Sun	Responds negatively to severe fires, if conducting controlled burns wet large patches to ensure they remain in the planting.
Yarrow	<i>Achillea millefolium</i>	High	Medium	Dry - Moist	60	30-90	Full Sun	Spreads by rhizomes which can become aggressive under ideal conditions.
Canada Anemone	<i>Anemone canadensis</i>	Medium	Medium	Moist	60-75	30-60	Part Shade - Full Sun	Can spread aggressively; Creates uniform ground cover.
Rosy Pussytoes	<i>Antennaria rosea</i>	High	Medium	Dry - Moist	30-50	45595	Part Shade - Full Sun	Responds negatively to severe fires, when conducting controlled burns wet large patches to ensure they remain in the planting.
Dwarf Milkweed	<i>Asclepias ovalifolia</i>	High	Medium	Dry - Moist	20-50	20-50	Full Shade - Full Sun	Plant contains latex, a common allergen, so gloves should be worn when handling.
Wild Strawberry	<i>Fragaria virginiana</i>	Medium	Medium	Dry - Moist	15-20	15-20	Part Shade - Full Sun	Plants spread horizontally and reproduce through stolons to create a ground cover.
Northern Bedstraw	<i>Galium boreale</i>	Medium	Low	Dry - Moist	30-45	60-90	Part Shade - Full Sun	Spreads by seed and rhizomes; ideal for soil stabilization.
Wild Bergamot	<i>Monarda fistulosa</i>	High	Medium	Dry - Moist	60-90	60-90	Full Sun	Requires occasional maintenance, can spread to form clumps and self seed.
Canada Goldenrod	<i>Solidago canadensis</i>	Medium	Low	Dry - Moist	50-100	50-100	Part Shade - Full Sun	Can be aggressive under ideal conditions.
Smooth Aster	<i>Symphyotrichum laeve</i>	Medium	Medium	Dry - Moist	30-90	30-90	Part Shade - Full Sun	Can directly seed into plantings, seeds do not require either scarification or stratification.
Purple Stemmed Aster	<i>Symphyotrichum puniceum</i>	Medium	Medium	Moist - Wet	60-90	60-150	Full Sun	Can spread rapidly and form large colonies in moist - wet areas.



Heart-leaved Alexanders	<i>Zizia aptera</i>	Medium	Medium	Dry - Moist	45-60	45-90	Part Shade - Full Sun	Low maintenance perennial.
Grasses								
Tufted Hairgrass	<i>Deschampsia caespitosa</i>	High	Low	Moist	30	40	Full sun	A clump forming perennial that can provide erosion control with its deep rhizomes.
Rocky Mountain Fescue	<i>Festuca saximontana</i>	High	High	Dry - Moist		20-25	Part Shade - Full Sun	Does well in disturbed or polluted areas but does not tolerate heavy foot traffic.
Sweetgrass	<i>Hierochloe odorata</i>	Low	High	Moist - Wet	60	30-60	Part Shade - Full Sun	One of the four sacred plants to Metis and Indigenous people; May triple in size within one year.
Junegrass	<i>Koeleria macrantha</i>	High	Low	Dry - Moist	30-60	30-60	Full Sun	Seedlings are weak and do not survive moderate to high foot traffic.
Shrubs								
Green Alder	<i>Alnus viridis</i>	Low	Low	Moist	300	300	Part Shade - Full Sun	Clearance from lowest branches to the ground can be up to 100 cm at maturity
Saskatoon Serviceberry	<i>Amelanchier alnifolia</i>	Low	Low	Dry - Moist	200-300	300-400	Full Sun	No clearance under the lowest branches could impede sightlines; Species is a decreaser without proper maintenance.
Bog Birch	<i>Betula pumila</i>	Low	Low	Moist - Wet	200-300	100-300	Part Shade - Full Sun	Low maintenance, minimal suckering and has a fast growth rate.
Red Osier Dogwood	<i>Cornus sericea</i>	Medium	High	Dry - Moist	300	300	Part Shade - Full Sun	Low maintenance, may require light pruning.
Beaked Hazelnut	<i>Corylus cornuta</i>	Medium	Low	Dry - Moist	100-200	100-200	Part Shade - Full Sun	Controlled burn will kill the above ground portion of the shrub, but it readily resprouts.
Wolf Willow	<i>Elaeagnus commutata</i>	High	Medium	Dry - Moist	200-400	200-400	Full Sun	Readily suckers, thicket forming.
Twinberry Honeysuckle	<i>Lonicera involucrata</i>	Medium	Low	Moist	150	300	Part Shade - Full Sun	Naturalizes through self-seeding and can form colonies overtime.
Shrubby Cinquefoil	<i>Potentilla fruticosa</i>	High	Medium	Dry - Wet	50-100	100-150	Part Shade - Full Sun	May require the removal of die back every spring.
Fire Cherry, Pin Cherry	<i>Prunus pensylvanica</i>	Medium	Medium	Dry - Moist	200-300	200-500	Full Sun	Clearance from lowest branches to the ground can be up to 120 cm at maturity, without pruning.
Golden Currant	<i>Ribes aureum</i>	High	Low	Dry - Moist	60-200	100-300	Part Shade - Full Sun	Plant may sucker under ideal conditions.

**Guideline****Low Impact Development Guidelines for Corner Lot Infill Developments****COE-IM-GUIDE-0036**

Wild Rose	<i>Rosa acicularis</i>	Low	Low	Dry - Moist	100	100	Part Shade - Full Sun	Requires occasional maintenance and upkeep, best pruned in late winter.
Beaked Willow	<i>Salix bebbiana</i>	Low	Low	Moist - Wet	100-600	300-1000	Part Shade - Full Sun	Short-lived and fast-growing; Susceptible to insect, disease, and wind damage.
Hoary Willow	<i>Salix candida</i>	Low	Low	Moist - Wet	50-100	50-100	Part Shade - Full Sun	Short-lived and fast-growing; Susceptible to insect, disease, and wind damage.
Pussy willow	<i>Salix discolor</i>	Medium	Medium	Wet	100-300	200-300	Part Shade - Full Sun	Branches will need maintenance annually.
Drummond's Willow	<i>Salix drummondiana</i>	Low	Low	Moist - Wet	100-300	200-400	Part Shade - Full Sun	Plant can sucker profusely.
Sandbar Willow	<i>Salix exigua</i>	Medium	Low	Moist - Wet	250-400	400-700	Part Shade - Full Sun	Plant can sucker profusely.
Gray leaf Willow	<i>Salix glauca</i>	Low	Low	Moist - Wet	200-300	120-200	Part Shade - Full Sun	Plant can sucker profusely.
Yellow Willow	<i>Salix lutea</i>	Low	Low	Moist	300	300-600	Full Sun	Fast growing; Some maintenance required.
Meadow Willow	<i>Salix petiolaris</i>	Medium	Low	Dry - Moist	300	300	Part Shade - Full Sun	Low maintenance; Forms dense spreading tidy clumps; Is good for erosion control.
Silver Buffaloberry	<i>Shepherdia argentea</i>	Medium	High	Dry - Moist	300	400	Full Sun	Tolerates the poor soils and does well in dry or alkaline situations; Low maintenance and extremely cold- and drought-tolerant.
Canada Buffaloberry	<i>Shepherdia canadensis</i>	High	Medium	Dry - Moist	200-300	100-200	Full Shade - Full Sun	Low maintenance. Extremely cold- and drought-tolerant.
White Meadow Sweet	<i>Spiraea alba</i>	Low	Low	Moist - Wet	50-150	100-200	Part Shade - Full Sun	Can sucker under ideal conditions. Remove spent flower clusters to promote additional bloom.
Snowberry	<i>Symphoricarpos albus</i>	High	Medium	Dry - Moist	100-200	100-200	Part Shade - Full Sun	Plants can sucker, prune as needed.
High-bush Cranberry	<i>Viburnum edule</i>	Low	Low	Moist	200-400	200-300	Part Shade - Full Sun	Thicket forming.



Table 2: Recommended Ornamental Plant Species for LID Facilities in Edmonton, Alberta

Common Name	Scientific Name	Drought Tolerance	Salt Tolerance	Soil Moisture Tolerance	Mature Spread (cm)	Mature Height (cm)	Sunlight Preference	Additional Information and Maintenance Considerations
Perennial								
Hillside Black Beauty Bugbane	<i>Actaea racemosa</i> 'Hillside Black Beauty'	Low	Medium	Moist - Wet	75-100	75-100	Shade - Sun	
Variegated Bishop's Goutweed	<i>Aegopodium podagraria</i> 'Variegata'	Medium	High	Dry - Wet	75-125	25-35	Shade - Sun	
Larkspur	<i>Delphinium sp.</i>	Low	Moderate	Average - Moist	Varies	Varies	Full Sun	
Bleeding Heart	<i>Dicentra sp.</i>	Low	Low	Average - Wet	Varies	Varies	Shade - Part Shade	
Daylily	<i>Hemerocallis sp.</i>	Moderate	Moderate	Dry - Moist	Varies	Varies	Part Shade - Full Sun	Consider reblooming daylily varieties for longer seasonal colour.
Hosta	<i>Hosta sp.</i>	Low	Low	Average - Moist	Varies	Varies	Shade - Part Shade	
Siberian Iris	<i>Iris sibirica</i>	High	High	Average - Wet	35-45	50-75	Part Shade - Full Sun	
Dead Nettle	<i>Lamium maculatum</i>	Moderate	Low	Dry - Wet	45-60	15-30	Shade - Part Shade	
Ostrich Fern	<i>Matteuccia struthiopteris</i>	Moderate	Moderate	Dry - Wet	100-150	50-75	Shade to Sun	
Globeflower	<i>Trollius spp.</i>	Low	Low	Average - Moist	35-45	60-75	Part Shade - Full Sun	
Grasses								
Tufted Hairgrass	<i>Deschampsia caespitosa</i>	High	Low	Moist	30	40	Full sun	A clump forming perennial that can provide erosion control with its deep rhizomes.
Ribbon Grass	<i>Phalaris arundinacea sp.</i>	Low	Moderate	Moist - Wet	60-100	75-90	Part Shade - Full Sun	

**Guideline****Low Impact Development Guidelines for Corner Lot Infill Developments****COE-IM-GUIDE-0036**

Shrubs								
Dogwoods	<i>Cornus sp.</i>	Low	Moderate	Dry - Moist	Varies	Varies	Part Shade - Full Sun	
Mockorange	<i>Philadelphus sp.</i>	Moderate	Moderate	Average - Moist	75-200	100-250	Part Shade - Full Sun	
Potentilla	<i>Potentilla sp.</i>	High	Moderate	Dry - Wet	Varies	Varies	Part Shade - Full Sun	May require the removal of die back every spring.
Willow	<i>Salix sp.</i>	Medium	Moderate	Dry - Moist	Varies	Varies	Part Shade - Full Sun	
Snowberry	<i>Symphoricarpos albus</i>	High	Moderate	Dry - Moist	100-200	100-200	Part Shade - Full Sun	Plants can sucker, prune as needed.



1.7. LID Drawing Requirements

Required plan view, detail, and profile view drawing details related to Low Impact Development features are listed in Table 3 below. This list does not replace or forgo existing drawing requirements as established by the City of Edmonton or EPCOR.

Table 3: Drawing Detail Requirements

Parameter	Lot Grading Plan		Landscape Plan		Site Servicing Plan (Mechanical Site Plan)			Description
	Plan	Detail	Plan	Detail	Plan	Detail	Profile	
Type of LID Facility	x		x		x	x	x	The type of LID using the definitions outlined in the Low Impact Development Facility Guidelines for Corner Lot 3 or 4 Unit Infill Developments document
Location	x	x			x			Areal extent shown on plan view including shape of LID Facilities.
Surface area		x				x		Outlined on plan view drawings, size of surface area of LID facility including the width and length of the LID facility.
Catchment	x				x			Delineated catchment area directed to LID facility, size of catchment area and impervious portion. This must include roof drainage details and which eaves are discharging to which downspout. The catchment area should include at minimum the total roof size for the primary dwelling and garage if applicable. If multiple LID facilities are to be constructed, the catchments for each facility should be shown.
Flow Arrows	x							From contributing/catchment area(s) and overflow route(s) including locations of swales/shared swales if required.
Slopes	x				x		x	Side slopes of the LID facilities as well as slope of ground adjacent to LID facility.
Materials/ Media Layers		x		x	x	x	x	Material specifications including depths/thickness and volumes required (LID soil media, filter layer, drainage layer), depth/thickness, hydraulic conductivity, porosity and any other material such as geotextiles or soil cells that may be required.
Materials/ Media Layers Piping					x	x	x	Piping size and specifications. There should be at least one profile view outlining all layers and materials within the LID facility, including pipe locations/underdrain is applicable.

**Guideline****Low Impact Development Guidelines for Corner Lot Infill Developments****COE-IM-GUIDE-0036**

Inlet	x				x	x	x	Shown on plan view or profile view and typical detail or type provided (curb cut, flow spreader, ribbon curb, pretreatment, catchbasin, etc.)
Overflow/ Outlet	x				x	x	x	Underdrain specification & slope (if applicable), spill elevation, catch basin type and grate, and overflow details
Erosion Control/ Energy Dissipation	x	x	x		x	x	x	Outlined location on profile and plan view (inlet, outlet if overland spill) and details, this should include both temporary and permanent measures (i.e. silt fence)
Cleanouts	x		x		x	x	x	Located on profileplan view, detailed with all piping details and catch basin overflow, if required.
Location of service connection (s) (if applicable)	x				x			Location(s) shown on plan view.
Landscaping			x	x				Planting plan and vegetation details species, mature density, succession plan, and location of plantings, planting bed detail

1.8. Erosion and Sedimentation Control Measures (ESC)

- i. Install appropriate ESC measures, including silt fencing around the entire extents of the LID facility to mitigate erosion of exposed areas, rough graded lots, and unlandscaped areas. Snow fencing should be installed as soon as grading and excavation in the vicinity of the LID facility has begun to ensure compaction of the area does not occur through machine movement and/or storage through/in the area. Once rough grade has been achieved, and the LID soil has been placed, silt fencing must be installed and remain in place until the plant material has been established. Silt fencing integrity should be checked periodically as part of maintenance. See Figure 7 for silt fence installation. Additional ESC measures such as a fibre roll may be required to stop sedimentation from entering the LID facility. See Figure 8 for fibre roll installation. All ESC measures for LID must be maintained during the plant material establishment period.

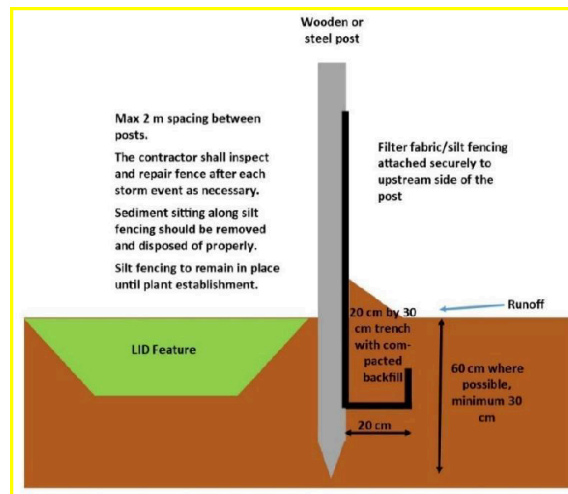

Figure 7: Silt Fence Installation

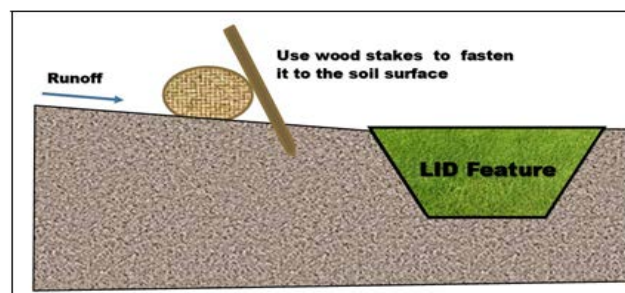

Figure 8: Fibre Roll Installation



- ii. Facilities shall be kept clean and shall not be used as erosion or sediment control structures during construction. If sediment enters the LID facility it must be removed, especially after storm events. Any contaminated runoff entering the LID facilities during project or adjacent construction has the potential to alter the soil criteria and will result in the affected soil volume requiring replacement. The footprint of the LID facility is to be protected during construction activities (see Section 1.10 – Construction Considerations for more details). Excavation to be conducted from outside edges of facilities where possible to minimize compaction to facility subgrades.
- iii. Additional erosion and sedimentation control measures are outlined in the City of Edmonton’s Erosion and Sedimentary Control (ESC) Guidelines and Field Manual and should be followed as applicable. These include: limit soil exposure to erosion, stabilize exposed soils, protect steep slopes and cuts, and assess and modify erosion and sediment control measures throughout construction and after storm events.

1.9. Construction Considerations

Project specifications should consider the following regarding construction of the LID facility and placement of the soil mix:

- i. Construction execution planning should give careful consideration to the sequencing and traffic flow of activities at and around the LID facility to minimize disturbance of the LID site. If possible the LID facility should be constructed near the end of the development.
- ii. The LID facility (s) should be isolated from runoff and sedimentation from the impervious catchment area until vegetation is established and ready to provide treatment as per design. This can be achieved by physically blocking flow with a barrier, or installing the LID facility after construction around the site has been completed. This is especially important in highly saline areas such as snow storage areas or adjacent to arterial roadways. If the LID facility cannot be isolated from runoff and sedimentation, ESC measures for the catchment must be put into place and thought should be taken to using plantings instead of seed.
- iii. The LID growing soil media fact sheet should be submitted and the layer should be inspected by qualified personnel at rough grade.
- iv. Subgrade excavation should be performed by suitable equipment and construction practices that will minimize compaction to the infiltration



area. The use of excavators reaching in from outside the infiltration footprint is preferred to limit compaction within the footprint of the LID facility. If excavation must be carried out within the footprint, light weight, low ground-contact pressure equipment must be used. If larger equipment is used within the footprint of the LID facility, the base of the facility must be tilled to a depth of 300 mm prior to construction of the LID facility. The developer and/or their representative must sign off (either via letter or on as-built drawings) that the footprint of the LID facility was not compromised due to compaction.

- v. Surface of the subgrade and/or granular layers may require scarification to provide proper bonding and transition between materials.
- vi. Gravel drain rocks should be placed uniformly in 300 mm lifts.
- vii. Soil, compost, and/or other amendments should be uniformly mixed prior to placement. Care should be taken to avoid compacting the mixture during the mixing process. For further information on acceptable soil amendment see the City of Edmonton's Volume 5 - Topsoil Specification 02910.
- viii. Soil mix should be placed uniformly in 200 mm to 300 mm lifts. Each lift should be water consolidated or compacted using a suitable method as per design specifications.

1.9.1. General Inlet and Outlet Considerations

LID facility design should consider the following regarding inlets and outlets:

- i. The location of the inlets and outlets must be situated to allow water to fully flow through and percolate into the LID Soil Media.
- ii. The overflow outlet must be situated near the center of the LID, between the inlet and the outlet to maximize water flow through the LID Soil Media. If the overflow outlet is located near the inlet, flow may short circuit the system and flow directly into the overflow.
- iii. Thought should be given to the type of erosion/flow control utilized at the inlets and outlets and the permanence of the installation. Rocks or splash pads are common methods for erosion and flow control.



- iv. Inlets, outlets, and overflows must be accessible for operations and maintenance. Care should be taken during vegetation selection to ensure that all will still be accessible at peak vegetation size.

1.10. LID Soil Media Specifications

The LID soil media must meet the requirements in this Section.

1.10.1. Texture and Property

The LID soil media specification in Table 4 provides a range of values for each parameter. It is at the discretion of the engineer and the landscape architect to determine the exact value and whether any additional tolerances are allowed outside the standard ranges for a specific project.

Table 4: LID Soil Media Specification

Parameter	Values
Texture classification	Loamy Sand; Sandy Loam
Sand sized particles, larger than 0.05 mm diameter and smaller than 2 mm diameter	60% – 80%
Silt	10% – 25%
Clay	5% - 15%
Silt and clay combined	Maximum 40%
Organic matter	5% – 10%
pH value	6-8
Phosphorus	10 - 60 ppm
Saturated Hydraulic conductivity, at soils specified compaction and moisture	Minimum 40 mm/hr, maximum 300 mm/hr

Notes: All % are in dry weight.

Sand: Sand sized particles shall have a well-graded distribution with a coefficient of uniformity between 4 and 6. Sand shall be free from clay balls and other extraneous materials.



1.10.2. Compaction and Infiltration

Compaction for the LID soil media is recommended to be specified at a minimum 75%-85% Standard Proctor density (SPD) depending on the soil type to be used; unless further compaction is required for structural purposes. Soil shall be placed in 300 mm lifts; unless otherwise specified by the designer.

Soils with a high organic content should still be lightly compacted to reduce settlement of the soil and LID facility.

When limiting compaction, care must be taken to follow the Construction Considerations located in Section 1.10.

1.10.3. Operations and Maintenance

The first two years of maintenance are critical to the long term success of the LID facilities. In addition to the checklist in Table 5 below, perform the following two tasks throughout the first two years after LID construction:

- i. Water your rain garden once a week, or as needed depending on rainfall.
- ii. Watch for bare or eroding areas in the rain garden or contributing area and stabilize by reseeding or adjusting garden slopes with soil and mulch.

After the first two years only the tasks outlined in Table 5 below will be required.



Table 5: Operations and Maintenance Checklist

Maintenance Checklist	April	May	June	July	August	September	October
Clean gutters of roof leader(s) and dispose of waste	X						
Clean out the inlet by shovel or hand and dispose of waste.	X						
Prune seed heads, shrubs, and grasses.	X						
Replace any dead or dying plants from the previous season.		X					
Repair erosion around and within the LID facility. This may include replacing rocks, plants, mulch or redirecting flow and reinforcing the slope as appropriate.		X					
Redistribute mulch that has shifted and replenish mulch if needed.		X					
Remove trash, debris and lawing clippings from inlet, rain garden and overflow/outlet.	As Needed						
Pull weeds, careful not to pull native plants.	As Needed						
Rake and bag/compost leaves from lawn area contributing to the LID facility before snow arrives.							X
Remove fallen leaves from inlet and overflow using a leaf blower or rake.							X