

Residential Infill Guidelines

A Manual of
Planning and Design Guidelines
for Residential Infill in Mature Neighbourhoods

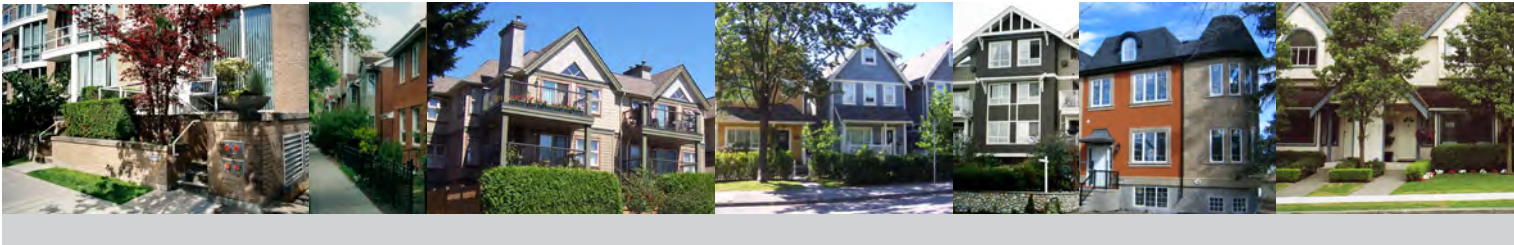

Planning and Policy Services Branch
Smart Choices Program

FINAL REPORT
GYdHya Vyf, 2009
Prepared By:



with assistance from





Table of Contents

- A. Introduction**
- B. Objectives for Residential Infill**
 - City Objectives
 - Neighbourhood Objectives
 - Development Industry Objectives
- C. Definitions of Forms of Residential Infill**
 - Small Scale Infill
 - Medium Scale Infill
 - Large Scale Infill
- D. General Guidelines for Residential Infill in Edmonton's Mature Neighbourhoods**
- E. Small Scale Infill Guidelines**
 - 1. Secondary Suites
 - 2. Garage Suites
 - 3. Garden Suites (Laneway Housing)
 - 4. Small Lots (Single Detached Houses)
 - 5. Semi Detached Houses (Side/Side Duplexes)
 - 6. Duplexes (Up/Down Duplexes)
 - 7. Fourplexes
 - 8. Row Housing (Up to and Including 5 Units)
- F. Medium Scale Infill Guidelines**
 - 1. Row Housing (6 or More Units)
 - 2. Stacked Row Housing (3 – 4 Storeys, 4 or More Units)
 - 3. Low Rise Apartments (3 – 4 Storeys)
- G. Large Scale Infill Guidelines**
 - 1. Mid Rise Apartments (5 – 8 Storeys)
 - 2. High Rise Apartments (9 Storeys or More)
- H. Large Site Infill Guidelines**
- I. Glossary of Terms**
- J. Implementation of the Residential Infill Guidelines**



Introduction

This Manual sets out planning and design guidelines that are intended to assist the City and the development industry in achieving high quality residential infill which is welcomed by neighbours and creates a livable environment for new residents.

Residential infill has been identified as a priority by City Council to assist in achieving three main goals:

1. Fiscal sustainability;
2. Environmental sustainability; and
3. Improved quality of development.

The City Planning and Development Department, as part of its Smart Choices Program, identified the need to provide guidance for the location, form and height of residential infill development in Edmonton's mature neighbourhoods. These Residential Infill Guidelines are an important tool in fostering infill development and achieving the above goals.

1. Area of Application

The Guidelines in this Manual apply only to residential infill development and only to Edmonton's mature neighbourhoods, which are identified in Map 1. The Guidelines apply to all forms of infill – from Secondary Suites to High Rise towers. In addition, they include a section specific to Large Residential Infill Sites.

It should be noted that as a first edition, the Manual deals only with standard forms of infill. Infill proposals involving more innovative forms will have to be evaluated based on a combination of the Guidelines and the development proposal's particular merits.

The Guidelines do not replace existing Area Redevelopment Plans (ARPs), though they may be used as a basis for future amendments (see Section J, Implementation).

A

**THE MANUAL —
Use and Format**

2. Format of the Manual

This Manual covers planning and design guidelines for all forms of residential infill. In using the Manual, it should be noted that:

- a. The format of the Manual allows the user to reference only those forms of infill which are of interest.
- b. Each form of infill is reviewed in a separate “pull out” format in the Manual and similar forms of infill are clustered together into three Sections covering Small Scale, Medium Scale, and Large Scale development.
- c. Each form of infill is treated in a standard format that includes guidelines with related illustrations on:
 - the Location and Distribution of the type of infill;
 - Built Form and Design;
 - Site Design and Streetscape; and,
 - Parking.
- d. A specific section of the Manual provides guidelines specific to the planning and design of residential infill on Large Sites.

3. Using the Manual

In addition to the specific Sections of the Manual dealing with each type of Residential Infill, the user should also note that the following information has been included in the Manual to assist in understanding and applying the Guidelines:

- a. The **Objectives** of the City in encouraging residential infill, along with the objectives that Neighbourhoods and the Development Industry have with respect to infill development.
- b. **Definitions** of the different types of infill, along with the zoning designation normally applied to the different forms of infill.
- c. A brief **Glossary of Terms**; many of the different studies, forms of infill, and planning processes have long titles in order to ensure clarity in their area of application. In order to address the readability of the Guidelines, the titles and references have been shortened. The Glossary may be referenced in the event of any confusion.
- d. An **Implementation Section** is included which gives guidance on how the Guidelines are to be used in the preparation and review of rezoning applications and plan amendments.

It is important to note that some flexibility will have to be exercised in the application of the Residential Infill Guidelines to respond to local context and the unique features of a site. Flexibility is required in the application of these ‘universal’ Guidelines because of the variation in geography and existing development that exists amongst the 107 Mature Neighbourhoods.

Whenever flexibility is exercised, the overall intent of the Guidelines must be kept in mind, and that is to achieve residential infill that is compatible and complimentary to the neighbourhood.

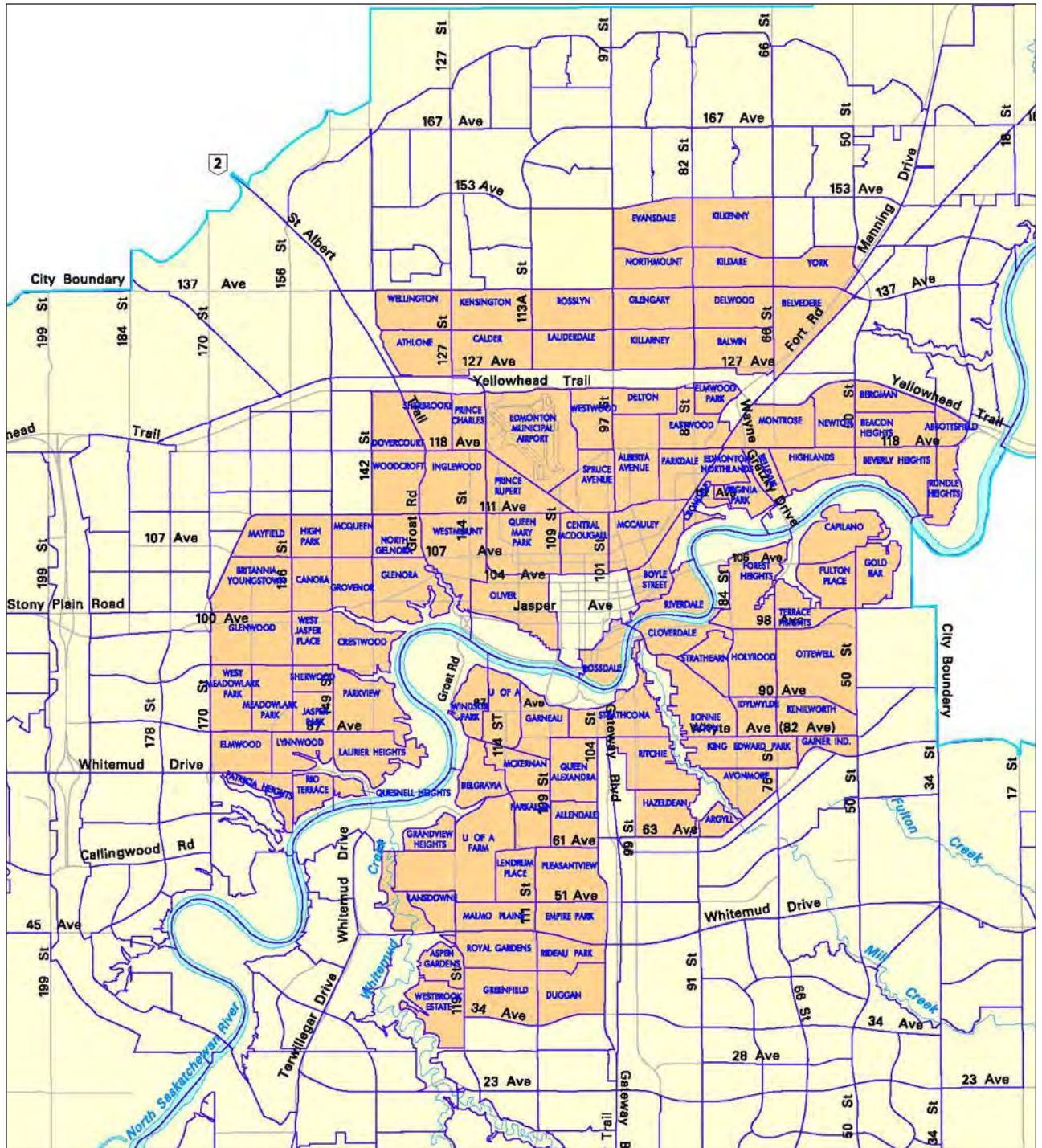

Map 1. Edmonton's Mature Neighbourhoods.

The Residential Infill Guidelines apply to the 107 Mature Neighbourhoods (shown in orange). Areas that are excluded include: the Downtown and the Downtown North Edge, and old and new Suburban Neighbourhoods (shown in yellow).

Objectives

Objectives for Residential Infill

B

The Residential Infill Guidelines are intended to achieve a number of objectives that have been articulated by the City, the community, and the development industry.

These objectives are summarized below as a means of establishing the context within which the Guidelines were drafted and the framework within which they will be implemented.

The City's objectives for residential infill have been articulated through the Smart Choices Program. These objectives also reflect the directions emerging from the current reviews of both the Municipal Development Plan (Focus Edmonton) and the Transportation Master Plan.

The objectives attributed to the community and development industry were derived through the consultation process associated with preparation of the Guidelines. Many objectives are shared between the three groups.

The objectives provided direction to the preparation of the Guidelines. They are relevant to both the City as a whole and to the neighbourhoods in which infill projects occur. It is intended that the application of the Guidelines will contribute to the achievement of these objectives as well as the fundamental goals of pursuing residential infill. These goals are:

1. To contribute to the creation of mature neighbourhoods that are livable and adaptable.
2. To foster residential infill that contributes to ongoing neighbourhood renewal and revitalization.
3. To encourage residential infill that contributes to the social, economic, and environmental sustainability of mature neighbourhoods and to the overall sustainability of the City.

There will be different perceptions and interpretations about what will lead to the achievement of healthy, adaptable, mature neighbourhoods. The Residential Infill Guidelines are intended to provide a consistent set of planning and design guidelines that will contribute to the achievement of the goals and objectives detailed here.

CITY

CITY OBJECTIVES

1. To contribute to the creation of livable mature neighbourhoods through residential infill by:
 - a. Developing animated and secure streets and open spaces;
 - b. Promoting high quality development, building materials, and design;
 - c. Providing for the inclusion of onsite and offsite amenities; and,
 - d. Increasing population levels to support retention of neighbourhood schools.
2. To reduce delays in the review of applications for residential infill due to conflict and a lack of clear policy direction.
3. To strive to secure community support and acceptance for residential intensification in mature neighbourhoods:
 - a. By minimizing traffic and parking impacts that may result from intensification;
 - b. By providing for a more equal distribution of density amongst neighbourhoods; and,
 - c. By ensuring that infill is compatible in terms of scale and architecture with existing and adjacent development.
4. To make more efficient use of existing infrastructure and community facilities.
5. To contribute to the physical renewal and revitalization of older neighbourhoods through:
 - a. New housing;
 - b. New and/or upgraded infrastructure, including storm and sanitary sewer, roads, lanes and sidewalks, boulevard landscaping and lighting;
 - c. Affordable housing; and,
 - d. Additional amenities such as green space, recreational facilities, and landscaping.
6. To locate density where it will support transit and maximize walkability.
7. To support community and neighbourhood commercial centres by:
 - a. Intensifying the population around community or regional shopping centres;
 - b. Redeveloping moderate to large commercial sites where housing diversity and choice can be provided; and,
 - c. Creating neighbourhood activity centres.
8. To achieve housing forms that contribute in the long term to:
 - a. Increased housing choice in mature neighbourhoods;
 - b. An increased supply of more affordable housing and non-market housing; and,
 - c. An increased supply of family-oriented housing.

NEIGHBOURHOOD OBJECTIVES

1. To maintain a balanced mix of housing within each neighbourhood and to distribute density amongst mature neighbourhoods.
2. To protect the stability of single family neighbourhoods.
3. To increase population levels to support retention of neighbourhood schools.
4. To develop animated and secure public streets and open spaces.
5. To minimize vehicular traffic and parking impacts that may result from intensification.
6. To secure improvements to neighbourhood infrastructure as part of redevelopment.
7. To use infill as an opportunity for the social renewal and revitalization of the community by:
 - a. Revitalizing schools through improved attendance;
 - b. Improving involvement in community leagues; and,
 - c. Improving community interaction.
8. To use residential infill as a way of improving levels of service and amenities through:
 - a. Gaining commercial retail services;
 - b. Making improved transit service viable; and,
 - c. Developing additional park and recreation facilities.
9. To provide additional housing opportunities that:
 - a. Allow seniors to “age in place” in their communities;
 - b. Make more homes available for families; and,
 - c. Provide more affordable housing.
10. To retain existing, good housing stock which provides affordable and family housing, or replace it with an equivalent amount of housing which is equally affordable.
11. To reduce the amount of time and effort required of the community to oversee development activity in the neighbourhood.

NEIGHBOURHOOD

DEVELOPMENT INDUSTRY

DEVELOPMENT INDUSTRY OBJECTIVES

1. To provide certainty on what infill development will be permitted in order to facilitate the identification of infill opportunities and the approval of planning applications.
2. To recognize the challenges inherent in the development economics of residential infill projects.
3. To provide flexibility in the regulation of residential infill projects to deal with the context within which projects occur by developing infill guidelines that:
 - a. Can be applied universally but will cover a range of situations; and,
 - b. Are performance based guidelines rather than detailed regulations.
4. To recognize that some older neighbourhoods are already more intensively zoned and developed.
5. To ensure that any requirements to provide for family housing or other forms of housing reflect the market demand for that housing.
6. That the City provide incentives to the industry to include particular amenities or to build in particular areas (for example, reduce parking requirements to encourage the construction of high rise residential at transit stations).

Definitions

Definitions of Forms of Residential Infill

This Manual of Residential Infill Guidelines refers to the different forms of infill as Small, Medium and Large Scale. Following is a brief description of each form of housing unit or building which falls within the different scales of residential infill development, along with the typical zoning designation that applies to that building form. For illustrations of the different infill forms refer to the form-specific sections of this Manual.

C

SMALL SCALE INFILL FORMS

1. Secondary Suites

Description

A Secondary Suite is a development consisting of a self-contained dwelling located within a single detached house. A Secondary Suite has its own cooking, food preparation, sleeping and bathing facilities and a separate entrance from the principal dwelling. This type includes conversion of basement space to a dwelling or the addition of new floor space for a secondary suite to an existing single detached dwelling.

Zoning

Maximum Height	2.5 storeys
Maximum Density	43 units/ha
Typical Zone	Permitted in most low density residential zones and Discretionary in most medium and high density residential zones

2. Garage Suites

Description

A Garage Suite is a development consisting of a self-contained dwelling located above a rear detached garage, or at grade sharing a wall with a detached garage. A Garage Suite has cooking, food preparation, sleeping and bathing facilities which are separate from those of the principal dwelling located on the lot and an entrance separate from the principal dwelling and the garage. A Garage Suite may have principal access from either the front street or the laneway.

Zoning

Maximum Height	6.5m but not to exceed height of principal dwelling
Maximum Density	43 units/ha
Typical Zone	Discretionary in most residential zones

SMALL SCALE

3. Garden Suites (Laneway Housing)

Description

A Garden Suite is a development consisting of a self-contained dwelling located physically apart from the primary dwelling at the rear of the lot. A Garden Suite has cooking, food preparation, sleeping and bathing facilities which are separate from those of the principal dwelling located on the lot and an entrance separate from the principal dwelling and the garage. These dwellings may have principal access from either the front street or the laneway.

Zoning

Maximum Height	4.3m
Maximum Density	43 units/ha
Typical Zone	Discretionary in most residential zones.

4. Small Lots (Single Detached Houses)

Description

Small Lot units are Single Detached dwellings that are typically built on lots that are less than minimum standard size and width under RF1 zoning. Typically these lots are 30 to 33 ft wide; they occur in some of the older mature neighbourhoods as a result of historical subdivision. They also may be created by consolidating two standard 50 foot wide lots and then subdividing into properties with smaller frontages. They are simply smaller homes in a tighter configuration than surrounding neighbourhood homes.

Zoning

Maximum Height	2.5 storeys
Maximum Density	37 units/ha
Typical Zone	RPL

5. Semi Detached Houses (Side/Side Duplex)

Description

Semi Detached houses consist of two dwellings joined on one side by a party wall. Each unit has individual access to the street.

Zoning

Maximum Height	2.5 storeys
Maximum Density	33 units/ha
Typical Zone	Permitted in RF3 and RF4, Discretionary in RF2

6. Duplexes (Up/Down duplex)

Description

Duplexes are two dwellings divided up and down with each storey being a separate dwelling unit. Each unit has individual access to the street.

Zoning

Maximum Height	2.5 storeys
Maximum Density	33 units/ha
Typical Zone	Discretionary under RF3 and RF4

SMALL SCALE**7. Fouxplexes****Description**

The Fourplex, a form of stacked row housing or apartment, is an arrangement of four dwelling units two deep - either vertically so that dwellings may be placed over others, or horizontally so that dwellings may be attached at the rear as well as at the side. Each dwelling has individual access to the street. From the street, the appearance is typically similar to a Semi-detached dwelling.

Zoning

Maximum Height	2.5 storeys
Maximum Density	50 units/ha
Typical Zone	Discretionary under RF3

8. Row Houses (up to 5 units)**Description**

Row Housing is a building containing three or more dwellings joined in whole or in part at the side only by a vertical party wall which is insulated against sound transmission. No dwelling is placed over another in whole or in part in a row housing configuration. Each dwelling has individual and direct access to the street and typically contains some private open space in front and back. Row houses typically require the consolidation of two lots.

Zoning

Maximum Height	2.5 storeys
Maximum Density	57 units/ha
Typical Zone	Permitted under RF5, and up to 4 units is discretionary under RF3

MEDIUM SCALE INFILL FORMS

MEDIUM SCALE

1. Row Housing (6 or more units)**Description**

Row Housing is a building containing six or more dwellings joined in whole or in part at the side only by a vertical party wall which is insulated against sound transmission. No dwelling is placed over another in whole or in part in a Row Housing configuration. Each dwelling has individual and direct access to the street and typically contains some private open space in front and back. Row houses of more than three units typically require the consolidation of at least two lots.

Zoning

Maximum Height	2.5 storeys
Maximum Density	42-54 units/ha
Typical Zone	Permitted under RF5

2. Stacked Row Housing (3-4 storeys, 5 or more units)**Description**

Stacked Row Housing is a type of Row Housing where dwellings are arranged two deep, either vertically (placed one over others) or horizontally (attached at the rear as well as at the side). Typically all units have individual access to the street via an exterior stairway.

Zoning

Maximum Height	4 storeys
Maximum Density	80 to 105 units/ha
Typical Zone	Permitted under RF6

3. Low Rise Apartments (3-4 storeys)**Description**

Low Rise Apartment housing contains many dwelling units within a building arranged in any horizontal or vertical configuration. All units share a ground level entrance and may share amenity space within the building or on the property.

Zoning

Maximum Height	4 storeys
Maximum Density	125 units/ha
Typical Zone	Permitted under RA7

LARGE SCALE INFILL FORMS

1. Mid Rise Apartments (5-8 storeys)

Description

Mid Rise Apartment housing typically contains many dwelling units within a building arranged in any horizontal or vertical configuration. All units share a ground level entrance and often contain some shared amenity space within the building or on the property.

Zoning

Maximum Height	8 storeys
Maximum Density	125-224 units/ha
Typical Zone	up to 6 storeys permitted under RA8, over 6 storeys requires RA9 or DC2

2. High Rise Apartments (9 or more storeys)

Description

High Rise Apartments are tall apartment buildings of nine storeys or higher.

Zoning

Maximum Height	9 or more storeys
Maximum Density	125 to 325 units/ha
Typical Zone	up to 14 storeys permitted under RA9, over 14 storeys requires DC2

LARGE SCALE

General Guidelines

General Guidelines For Residential Infill in Edmonton’s Mature Neighbourhoods

The following Guidelines are generally applicable to all infill development. The extent to which the Guidelines are applicable will vary according to the scale of the proposed development.

1. The planning and design of residential infill projects in mature neighbourhoods should contribute to a more environmentally sustainable city.

Infill projects contribute to improved environmental sustainability in the City through by:

- a. Enhancing opportunities for people to use transit;
- b. Enhancing opportunities for active transportation such as walking and cycling;
- c. Using building form and construction techniques that create buildings that are adaptable to reuse, such as above ground parking garages;
- d. Incorporating sustainable development/green building features that qualify for LEED or LEED-ND certification equivalents in all residential infill projects, particularly Medium and Large Scale projects. Such features include:
 - i. Utilizing building standards/materials and appliances that achieve high energy efficiency;
 - ii. Incorporating alternative heat and electrical energy sources (solar, geothermal);
 - iii. Maximizing opportunities to cool interiors through natural ventilation;
 - iv. Installing plumbing fixtures that conserve water;
 - v. Designing for the reuse of grey water and/or storm water on site;
 - vi. Utilizing high efficiency irrigation, drought tolerant plants, and native species for landscaped areas (xeriscaping);
 - vii. Inclusion of green roofs;
 - viii. Salvaging and recycling of building materials during construction; and,
 - ix. Orienting buildings on large sites, where possible, to take advantage of passive solar heat gain.

D

2. Residential infill projects should contribute to the creation and maintenance of socially sustainable mature neighbourhoods.

Infill projects should contribute to improved social sustainability of the City's mature neighbourhoods through such initiatives as:

- a. Consulting with the community through the planning and design process;
- b. Providing for a range of housing types that includes housing for seniors, families with children, and affordable housing; and,
- c. Maintenance and improvement of community recreation facilities and amenities.

3. Residential infill projects should contribute to the creation and maintenance of a more economically and fiscally sustainable City.

Residential infill projects in mature neighbourhoods should contribute to the economic and fiscal sustainability of the City by:

- a. Using existing water, sewer, drainage and transportation infrastructure more efficiently and supporting the upgrading of this infrastructure where required;
- b. Developing residential densities and neighbourhood forms that will support efficient transit services; and,
- c. Maintaining viable neighbourhoods in which property owners maintain their dwellings and population levels support neighbourhood services.

4. A critical mass of single family housing should be protected in the core of mature neighbourhoods.

This will be accomplished by:

- a. Allowing a modest amount of Small Scale infill within the interior of neighbourhoods;
- b. Directing the majority of infill to the edges of neighbourhoods or onto large sites.

It is a City objective to achieve a balanced mix of housing within, and a "fair share" distribution of density and residential infill among, mature neighbourhoods. This also contributes to the objective of maintaining stable, livable family-oriented neighbourhoods. Focusing infill development on the edge of the neighbourhood, on block ends, and

across from neighbourhood schools will help to minimize parking and traffic impacts on the interior of the neighbourhood, and restrict the number of single detached homes in the interior of the neighbourhood that can be redeveloped to more intensive uses.

5. Higher intensity infill development should be focused on the edge of neighbourhoods.

Directing high intensity infill to the edge of neighbourhoods will:

- a. Encourage the revitalization of those areas that are generally in the greatest need;
- b. Place higher density development closer to transit service; and,
- c. Create opportunities for sustainable community focal points to be shared by bordering neighbourhoods.

6. Affordable housing should be provided in residential infill projects in accordance with current City policy.

An objective related to residential infill is to improve the supply of affordable housing. Edmonton is pursuing City wide initiatives to add to the supply of affordable housing. Infill developments will be required to include an affordable housing component as determined by City policy.

7. Crime Prevention Through Environmental Design (CPTED) Principles should be applied to all Medium and Large Scale residential infill projects in accordance with the Edmonton Zoning Bylaw.

All residential infill development projects should incorporate CPTED principles, which include:

- a. Natural Surveillance - the placement of physical features and/or activities in ways that maximize natural visibility or observation;
- b. Natural Access Control – the use of design to deter access to an area; and,
- c. Legibility of Public/Private Space – the design of public and private space to maximize the spatial definition and minimize the ambiguity between them. This helps to develop a sense of proprietorship over an area and enhances security.

8. Residential infill developments should respect the role of lanes not only as a primary vehicular access route but as a factor in maintaining the livability of neighbourhoods.

Importance should be placed on the public realm of lanes as part of both a service and pedestrian network. Lanes should be considered in the design of infill development and kept attractive through fencing and landscaping, and appropriate design of parking areas and garages.

9. Residential infill is encouraged on sites in proximity to LRT stations, on high frequency transit corridors and at major shopping centres.

Medium and Large Scale residential infill is encouraged on sites in proximity to LRT stations, on high frequency transit corridors identified in the Transportation Master Plan and at major shopping centres. The location and distribution of higher density infill development in the vicinity of transit stations should be determined through a Transit Oriented Development Plan.

10. Infill development should foster a high quality public realm, a comfortable environment for walking, and new or improved connections within a neighbourhood.

Sidewalks should be provided that tie into existing pedestrian networks. They should be sufficiently wide and well maintained to encourage walkability and be constructed using a high standard of materials and treatments. Infill development should respect existing pedestrian movement patterns and should look for opportunities to provide new or improved connections. Medium and Large Scale developments should provide landscape plans that include the public realm. Where appropriate, a high standard of planting, sidewalk and boulevard improvements, including street furniture, should be provided.

11. Infill development should respect the mass and scale of adjacent development and the character and attributes of the existing streetscape.

Infill development should fit comfortably into an existing neighbourhood and reflect the character of the existing streetscape.

12. Individual homes should not be isolated between infill developments.

A Single Detached Dwelling should not be isolated between two Medium Scale infill projects or between a Medium Scale infill project and another land use.

13. Transit service and facilities should be considered when redevelopment is proposed

Transit service should be designed into new developments where required. In all cases where improvements or changes to the public sidewalk and boulevards are being planned:

- a. Existing stops should be retained, where feasible, so that they do not need to be relocated; and,
- b. Transit passenger pads should be constructed next to the sidewalk.

14. Mechanical systems should be located to ensure that noise does not impact adjacent residences.

The location of mechanical systems such as air conditioning units and exhaust fans should ensure that noise from these systems does not impact on adjacent residences.

15. Medium and Large Scale residential development should be designed to accommodate an aging population.

Special consideration should be given to features such as building and unit access, design of indoor and outdoor recreation and amenity space, lighting, signage, and safety features to accommodate an aging population.

Secondary Suites

Planning and Design Guidelines for Residential Infill in Mature Neighbourhoods

Notes on Using the Infill Guidelines

These Infill Guidelines for Secondary Suites are part of an overall set of Residential Infill Guidelines. In reviewing these Guidelines the following sections of the complete Residential Infill Guidelines document should also be consulted:

1. Section B, Objectives for Residential Infill;
2. Section D, General Guidelines for Residential Infill in Edmonton's Mature Neighbourhoods; and,
3. Section J, Implementation of the Residential Infill Guidelines.

In addition, other regulations established by the City of Edmonton may apply, including:

1. The City of Edmonton Zoning Bylaw, including the Mature Neighbourhood Overlay;
2. An Area Redevelopment Plan may be in place which establishes specific requirements.

These Residential Infill Guidelines, together with the other plans and regulations, will determine whether or not a Secondary Suite will be permitted and will establish any specific requirements that may need to be addressed before it can be approved.

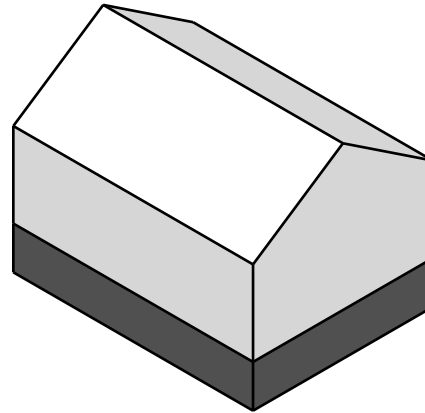

E1

A Secondary Suite is a self-contained dwelling located within a single detached house. A Secondary Suite has its own kitchen, sleeping and bathroom facilities and an entrance separate from the entrance to the principal dwelling.

Secondary Suites have little impact on the outward appearance of the existing dwelling and streetscape in that they are typically created through the conversion of existing space or through the addition of new floor space to the existing dwelling.





Location + Distribution

1. Secondary Suites may be constructed anywhere in a neighbourhood.
2. Only one Secondary Suite should be on a lot.
3. Secondary Suites should not be part of another form of multiple housing.





Built Form + Design

1. All Secondary Suites should have access to outdoor amenity space on site, which may be used in common with the principal dwelling.
2. Any renovations required to the exterior of the existing building should retain the character of a single detached residence.
3. Separate entrances should be provided and should be located at the side or rear of the principal dwelling or in a common indoor landing.

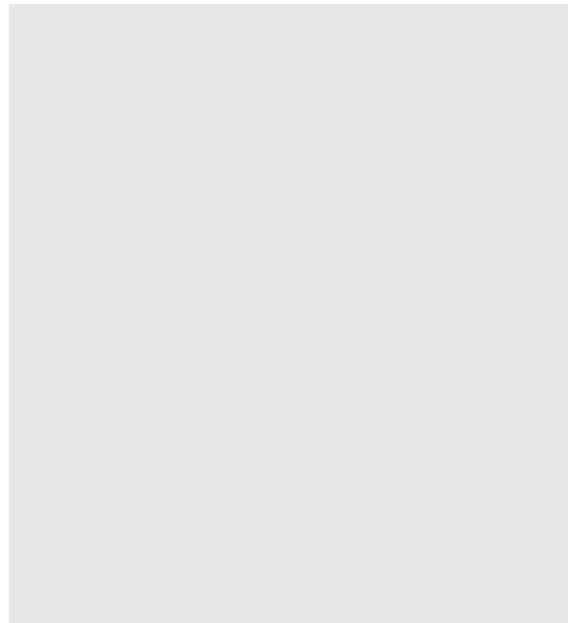

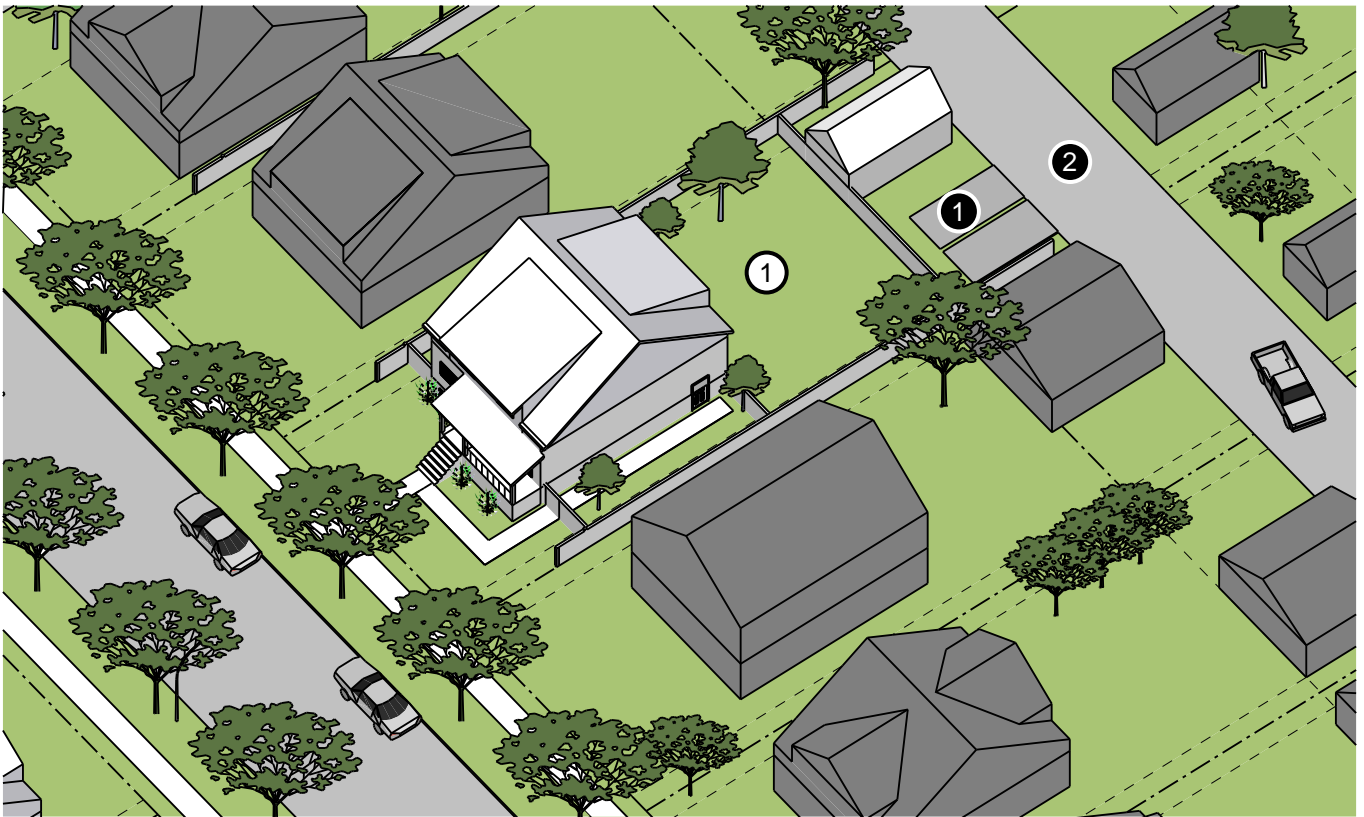

Site Design + Streetscape

①

1. Back yard amenity space should be retained on site after all parking requirements have been met.

Parking

①

1. Sufficient onsite parking should be provided for both the Secondary Suite and the principal dwelling as required by the Zoning Bylaw.
2. Parking should be accessed from the adjacent rear lane.
3. Parking should be located to ensure the retention of some onsite amenity space.

FOR MORE INFORMATION

Smart Choices Program, Planning and Policy Services Branch
 Planning and Development Department
 6th Floor, 10250 - 101 Street N.W. Edmonton, AB T5J 3P4
 PHONE (780) 496-6238 FAX (780) 401-7066
 www <http://www.edmonton.ca/smartchoices>

Garage Suites

Planning and Design Guidelines for Residential Infill in Mature Neighbourhoods

Notes on Using the Infill Guidelines

These Infill Guidelines for Garage Suites are part of an overall set of Residential Infill Guidelines. In reviewing these Guidelines, the following sections of the complete Residential Infill Guidelines document should also be consulted:

1. Section B, Objectives for Residential Infill;
2. Section D, General Guidelines for Residential Infill in Edmonton's Mature Neighbourhoods; and,
3. Section J, Implementation of the Residential Infill Guidelines.

In addition, other regulations established by the City of Edmonton may apply, including:

1. The City of Edmonton Zoning Bylaw, including the Mature Neighbourhood Overlay;
2. An Area Redevelopment Plan may be in place which establishes specific requirements.

These Residential Infill Guidelines, together with the other regulations, will determine whether or not a Garage Suite will be permitted and will establish any specific requirements that may need to be addressed before it can be approved.

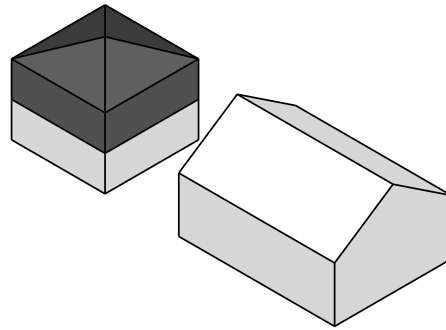

E2

A Garage Suite is a self-contained, Accessory Dwelling located above a rear detached garage with kitchen, sleeping and bathroom facilities which are separate from those of the principal dwelling located on the lot.

A Garage Suite is typically developed as a separate self-contained living unit above a detached garage at the rear of an existing Single Detached home. They may also be developed at grade and share a wall with a rear detached garage. In this context, they can be constructed with little impact on the appearance of the existing streetscape.

Garage Suites may function as a Secondary Suite or can be used to provide an opportunity for family members to live more independently. However, because the additional height of the garage and the location of the suite at the rear of the lot may create issues related to the privacy of adjacent dwellings, separation and screening requirements must be met.



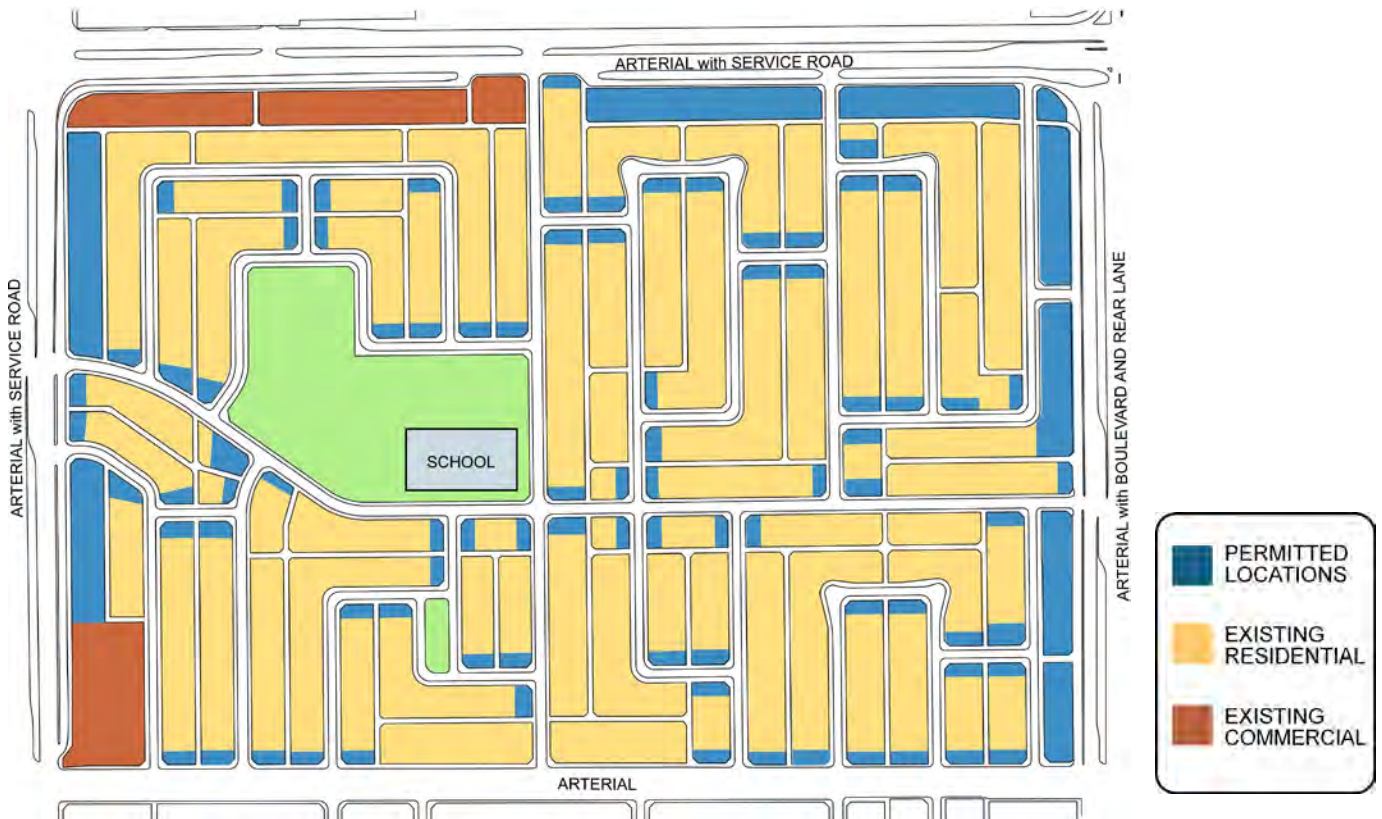

1. Garage Suites may be located at the following locations:
 - a. On corner lots throughout the neighbourhood;
 - b. On lots fronting onto a service road;
 - c. On lots backing onto a lane adjacent to an arterial road that is separated from the lane by a landscaped boulevard;
 - d. On lots abutting or separated by a laneway from sites zoned for Row Housing, Apartments, Community Services or Public Parks.
2. Only one Garage Suite should be located on a lot.
3. Garage Suites should not be located on a lot which has any form of multiple housing.



K.Trzaska



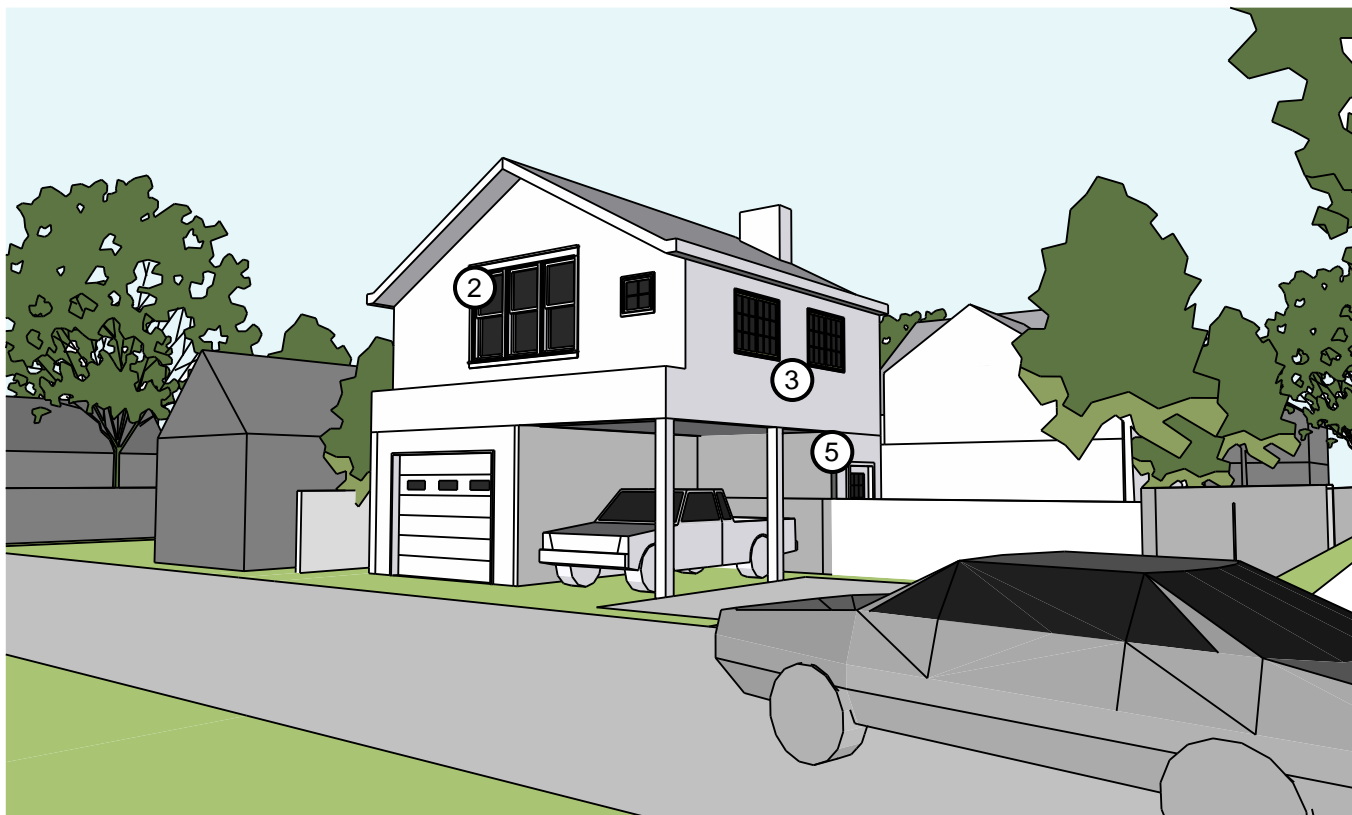

Built Form + Design

1. Maximum height should not exceed 6.5 metres (sloped roof), 5.5 metres (flat roof) or the height of the principal building, whichever is the lesser, to respect privacy and minimize shading on neighbouring properties.
2. At least one window of the suite should face onto the lane.
3. Windows should be placed to minimize overlook of neighbouring properties.
4. Garage Suites should be consistent with the materials and proportions of the principal dwelling, and should:
 - a. Incorporate fundamental design elements found within the neighbourhood;
 - b. Be constructed of quality, durable materials; and,
 - c. Be of a character that minimizes visual impact on and maximizes integration with the existing neighbourhood.
5. The suite should have a separate entrance.





Site Design + Streetscape

0

1. Garage Suites should minimize their footprint in order to maximize open space.
2. Site coverage should not exceed that allowed in the Zoning Bylaw.
3. The site design should, in concert with the design and placement of the building, optimize access to sunlight, and minimize overlook and loss of privacy on adjacent properties.
4. Backyard amenity space should be retained on site after all parking requirements have been met.

Parking

0

1. Sufficient onsite parking should be provided for both the Garage Suite and the principal dwelling as required by the Zoning Bylaw.
2. Parking should be accessed from the adjacent rear lane.
3. Parking should be located to ensure the retention of some onsite amenity space.

FOR MORE INFORMATION

Smart Choices Program, Planning and Policy Services Branch
 Planning and Development Department
 6th Floor, 10250 - 101 Street N.W. Edmonton, AB T5J 3P4
 PHONE (780) 496-6238 FAX (780) 401-7066
 www <http://www.edmonton.ca/smartchoices>



Garden Suites

Planning and Design Guidelines for Residential Infill in Mature Neighbourhoods

Notes on Using the Infill Guidelines

These Infill Guidelines for Garden Suites are part of an overall set of Residential Infill Guidelines. In reviewing these Guidelines, the following sections of the complete Residential Infill Guidelines document should also be consulted:

1. Section B, Objectives for Residential Infill;
2. Section D, General Guidelines for Residential Infill in Edmonton's Mature Neighbourhoods; and,
3. Section J, Implementation of the Residential Infill Guidelines.

In addition, other regulations established by the City of Edmonton may apply, including:

1. The City of Edmonton Zoning Bylaw, including the Mature Neighbourhood Overlay;
2. An Area Redevelopment Plan may be in place which establishes specific requirements.

These Residential Infill Guidelines, together with the other regulations, will determine whether or not a Garden Suite will be permitted and will establish any specific requirements that may need to be addressed before it can be approved.

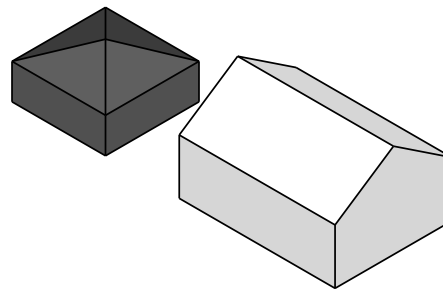

E3

A Garden Suite is an at-grade self-contained, accessory dwelling located in a building that is physically separate from the principal dwelling, containing kitchen, sleeping and bathroom facilities.

Garden Suites may function as Secondary Suites, or can be used to provide an opportunity for family members to live more independently. Garden Suites do not change the appearance of the principal dwelling; hence they have little impact on the character of the street or the appearance of the neighborhood generally.

However, because a Garden Suite adds to the site coverage and its location at the rear of the lot may create privacy issues for abutting properties, requirements related to separation, screening, parking and location of windows, doors, and amenity should be addressed.

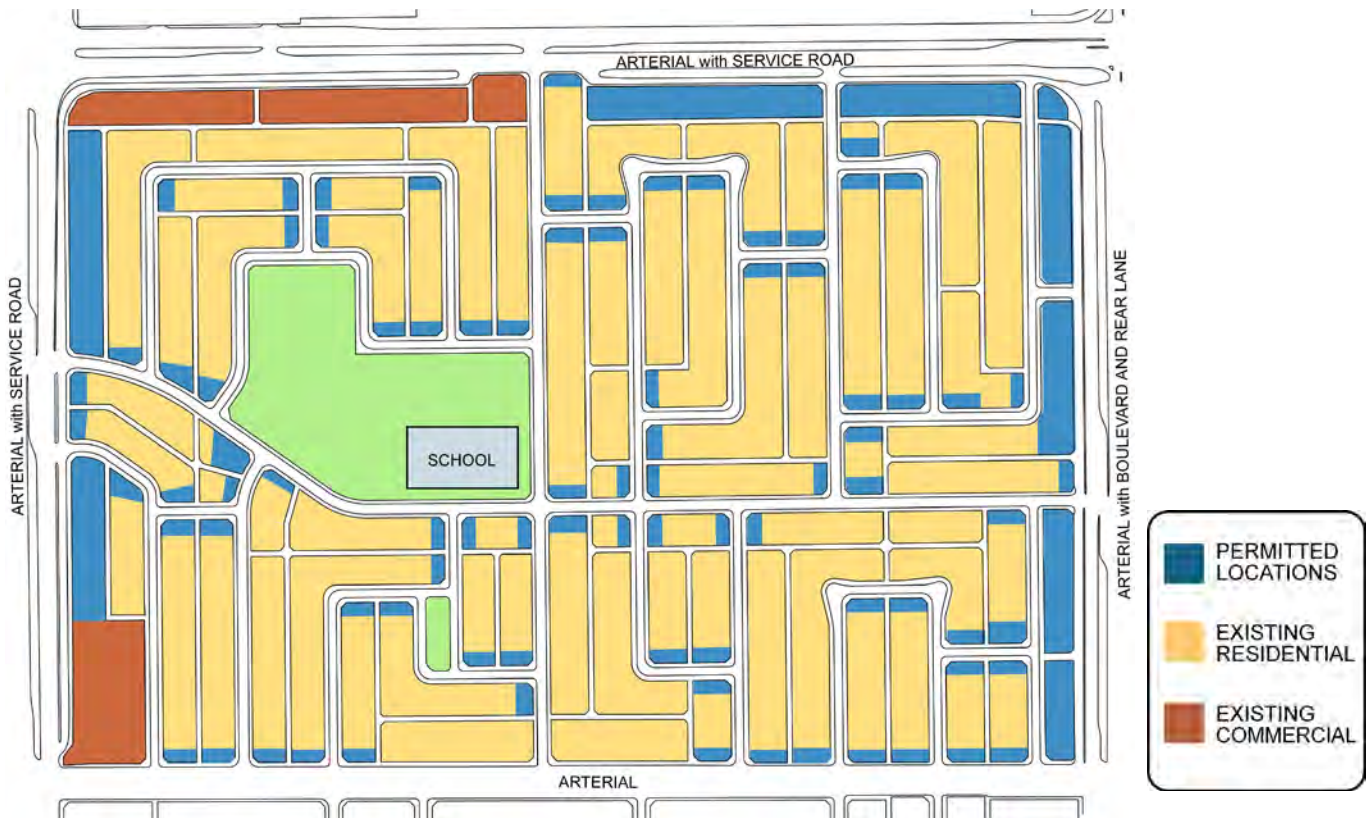

Location + Distribution

1. Garden Suites may be located at the following locations:
 - a. On corner lots throughout the neighbourhood;
 - b. On lots fronting onto a service road;
 - c. On lots backing onto a lane adjacent to an arterial road that is separated from the lane by a landscaped boulevard;
 - d. On lots abutting or separated by a lane from sites zoned for Row Housing, Apartments, Community Services or Public Parks.
2. Only one Garden Suite should be located on a lot.
3. Garden Suites should not be located on a lot which has any form of multiple housing.

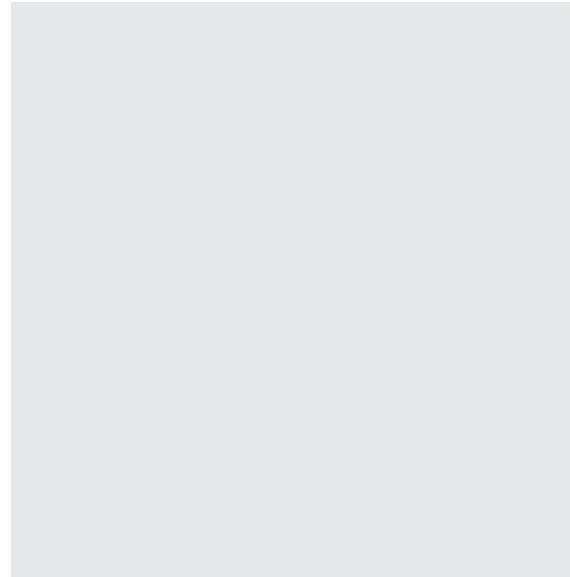



Built Form + Design

1. Maximum height should not exceed one storey.
2. If a Garden Suite shares a wall with a detached garage, creating the appearance of one structure, the longest walls of the structure should:
 - a. Face the lane and the principal dwelling to reduce impacts on abutting properties; or,
 - b. Have a significant set-back from the abutting properties, and;
 - c. Be off-set, articulated, and incorporate design features to reduce the massing and monotony of a long unbroken wall.
3. The design of Garden Suites should be compatible with the siting, grade elevations, roof slopes, building style and materials characteristic of the principal dwelling.
4. To ensure privacy of the abutting properties and the principal dwelling, Garden Suites should:
 - a. Have windows that are off-set from those of abutting structures; and,
 - b. Have larger windows facing a lane, flanking street, or the larger of any side yard; and,
 - b. Locate balconies so that they face the lane or flanking street.



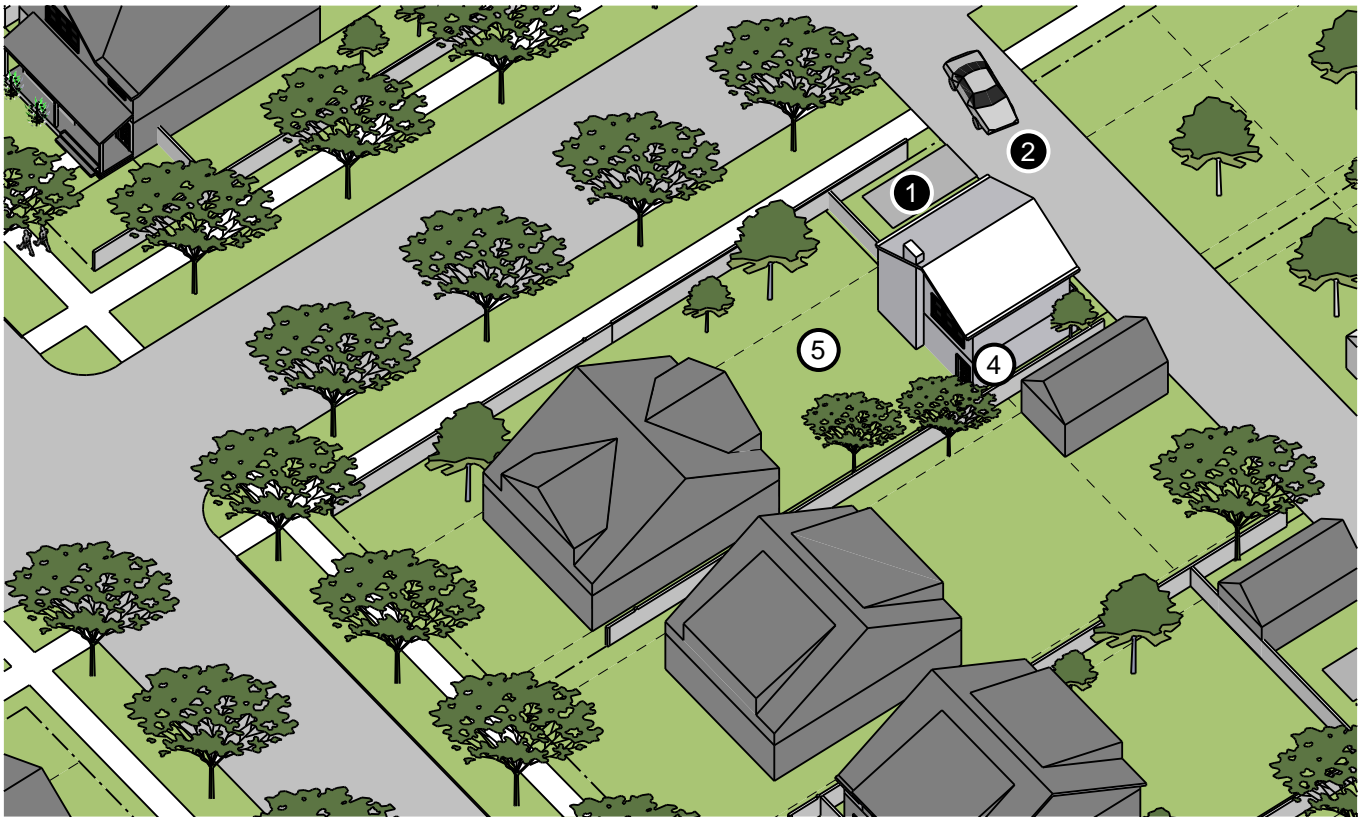

Site Design + Streetscape

①

1. Garden Suites should minimize their footprint in order to maximize open space.
2. Site coverage should not exceed that allowed in the Zoning Bylaw.
3. Site coverage for accessory buildings may be increased to accommodate both a Garden Suite and detached garage on a lot.
4. The site design should, in concert with the design and placement of the building, optimize access to sunlight and minimize overlook and loss of privacy on adjacent properties.
5. Sufficient separation space between the Garden Suite and principal dwelling should be provided to accommodate an amenity area for one or both dwellings.
6. Backyard amenity space for one or both dwellings should be retained on site after all parking requirements have been met.

Parking

①

1. Sufficient onsite parking should be provided for both the Garden Suite and the principal dwelling as required by the Zoning Bylaw.
2. Parking should be accessed from the rear lane.
3. Parking should be located to ensure the retention of some onsite amenity space.

FOR MORE INFORMATION

Smart Choices Program, Planning and Policy Services Branch
 Planning and Development Department
 6th Floor, 10250 - 101 Street N.W. Edmonton, AB T5J 3P4
 PHONE (780) 496-6238 FAX (780) 401-7066
 www <http://www.edmonton.ca/smartchoices>



Small Lot Infill

Planning and Design Guidelines for Residential Infill in Mature Neighbourhoods

Notes on Using the Infill Guidelines

These Guidelines for Small Lot Infill are part of an overall set of Residential Infill Guidelines. In reviewing these Guidelines, the following sections of the complete Residential Infill Guidelines document should also be consulted:

1. Section B, Objectives for Residential Infill;
2. Section D, General Guidelines for Residential Infill in Edmonton's Mature Neighbourhoods; and,
3. Section J, Implementation of the Residential Infill Guidelines.

In addition, other regulations established by the City of Edmonton may apply, including:

1. The City of Edmonton Zoning Bylaw, including the Mature Neighbourhood Overlay;
2. Any Area Redevelopment Plan that may be in place which establishes specific requirements.

These Residential Infill Guidelines, together with the other plans and regulations, will determine whether or not a Small Lot Infill development will be permitted and will establish any specific requirements that may need to be addressed before it can be approved.

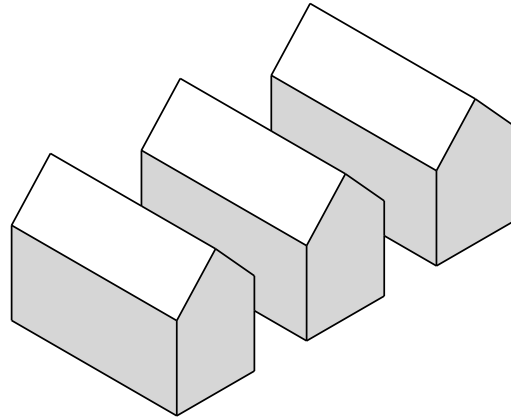

E4

Small Lot Infill dwellings are Single Detached dwellings that are typically built on lots that are 30 to 33 feet wide.

Small Lot Infill housing is usually created in existing neighbourhoods by consolidating two standard 50 foot wide lots and then subdividing the consolidated lot into three parcels with smaller frontages.





Location + Distribution

1. Small Lot Infill dwellings may be located anywhere in a neighbourhood where there is lane access.

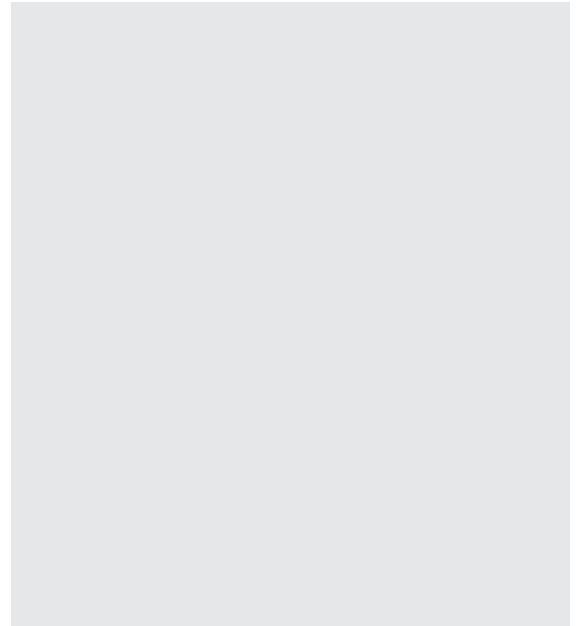



Built Form + Design

1. To minimize visual impact on and maximize integration with the existing neighbourhood, Small Lot Infill homes should:
 - a. Use durable, quality building materials that are similar or complimentary to those found within the neighbourhood;
 - b. Be in proportion with existing homes within the neighbourhood; and,
 - c. Incorporate fundamental design elements found within the neighbourhood.
2. Each building in a Small Lot development should be designed to be architecturally distinct through the use of different rooflines and facades, including type and placement of windows, doors and entryways.
3. The design and placement of the buildings should minimize any loss of privacy or sunlight on adjacent homes.





Site Design + Streetscape

①

1. A Small Lot development consisting of six or more Single Detached Houses may be subject to the requirement of a landscape plan which includes an assessment of mature trees on site and provides for their retention to the greatest extent possible.
2. The site design should, in concert with the design and placement of the buildings, minimize loss of sunlight and minimize overlook and loss of privacy on adjacent properties.
3. Lots should not be created which have a frontage of less than 65 percent of the average lot width on the block face.

Parking

②

1. Sufficient onsite parking should be provided as required by the Zoning Bylaw.
2. Parking should be accessed from the abutting rear lane.
3. There should be no driveways and curb cuts onto fronting streets unless the access is in accordance with the requirements of the Mature Neighbourhood Overlay.

FOR MORE INFORMATION

Smart Choices Program, Planning and Policy Services Branch
 Planning and Development Department
 6th Floor, 10250 - 101 Street N.W. Edmonton, AB T5J 3P4
 PHONE (780) 496-6238 FAX (780) 401-7066
 www <http://www.edmonton.ca/smartchoices>

Semi Detached Houses

Planning and Design Guidelines for Residential Infill in Mature Neighbourhoods

Notes on Using the Infill Guidelines

These Infill Guidelines for Semi Detached Houses are part of an overall set of Residential Infill Guidelines. In reviewing these Guidelines, the following sections of the complete Residential Infill Guidelines document should also be consulted:

1. Section B, Objectives for Residential Infill;
2. Section D, General Guidelines for Residential Infill in Edmonton's Mature Neighbourhoods; and,
3. Section J, Implementation of the Residential Infill Guidelines.

In addition, other regulations established by the City of Edmonton may apply, including:

1. The City of Edmonton Zoning Bylaw, including the Mature Neighbourhood Overlay;
2. Any Area Redevelopment Plan that may be in place which establishes specific requirements.

These Residential Infill Guidelines, together with the other plans and regulations, will determine whether or not a Semi Detached House development will be permitted and will establish any specific requirements that may need to be addressed before it can be approved

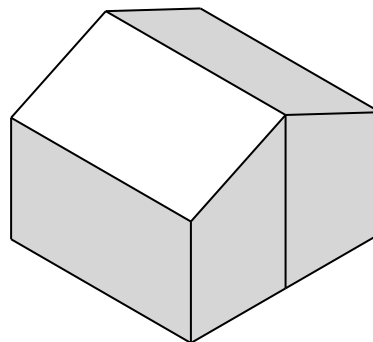

E5

Semi Detached Houses, sometimes described as “Side by Side Duplexes”, are two dwellings joined on one side by a party wall in the form of a two unit row house, with each unit having individual access to the street. These houses are very similar in scale to a single detached dwelling and with appropriate design can be easily integrated into the neighbourhood.

Semi Detached Houses are typically developed on an existing single detached lot, and are often strata titled so that they are individually owned.



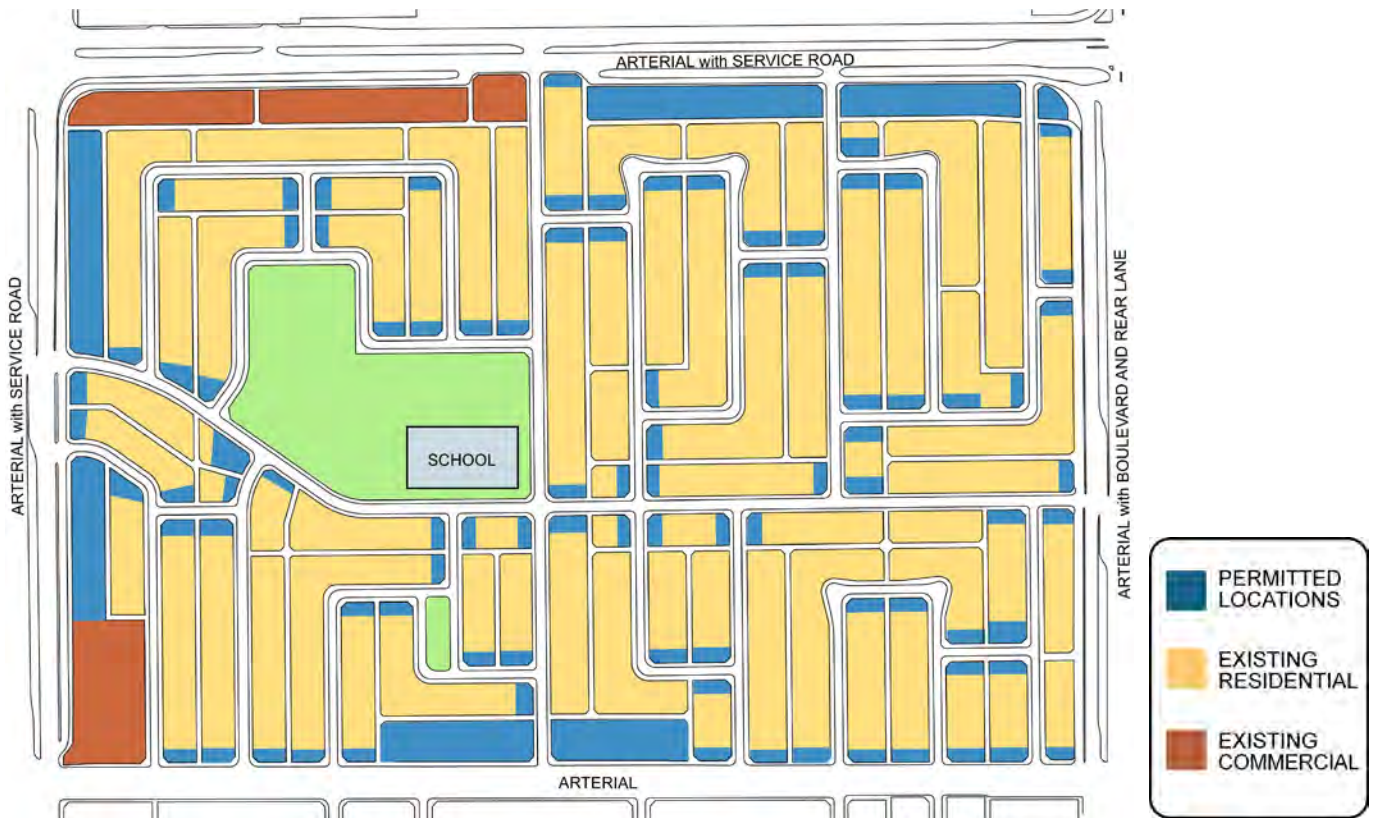

Location + Distribution

1. Semi Detached Houses may be located in the following areas:
 - a. On any corner site throughout a neighbourhood;
 - b. On a lot between two existing Semi Detached Houses;
 - c. On the edge of a neighbourhood, where the lot fronts or flanks onto an arterial or service road;
 - d. On large sites that are being developed as part of a comprehensive plan.





Built Form + Design

1. To maximize visual integration with the existing neighbourhood, Semi Detached Houses should:
 - a. Either be designed with an asymmetric balance in the building form, proportion, and distribution of openings such that the units do not “mirror” each other; or,
 - b. Be designed so that each unit has significant architectural features (rooflines, front entrances, windows, and design details) that distinguish it from the other unit; and,
 - c. Be constructed with quality, durable building materials that are similar or complimentary to those found within the neighbourhood;
 - d. Be in proportion with existing homes within the neighbourhood; and,
 - e. Incorporate fundamental design elements found within the neighbourhood.
2. Massing and placement of the building should be designed to avoid overlook and privacy concerns, and to optimize access to sunlight on adjacent properties.
3. The privacy of adjacent dwellings should be maintained through careful placement of windows, doors, decks, and patios.



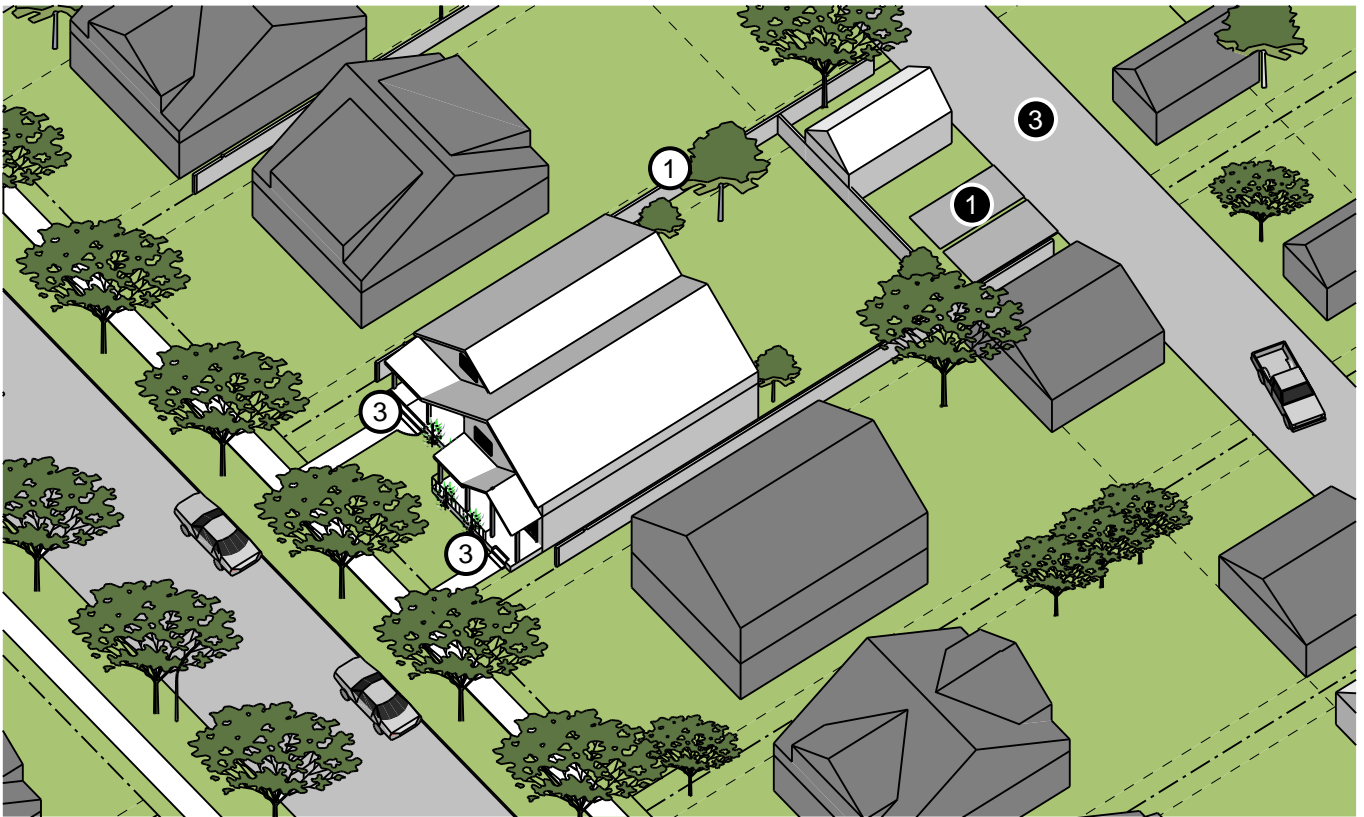

Site Design + Streetscape

0

1. An assessment of mature trees on the site should be provided and should describe how these trees will be retained.
2. The privacy of adjacent homes should be maintained through the use of fencing, screening, and landscaping.
3. Both units should have front door access to the street.

Parking

0

1. Sufficient onsite parking should be provided as required by the Zoning Bylaw.
2. Semi Detached Houses should have direct access to a lane from which parking can be accessed.
3. Parking should be accessed from the adjacent lane.

FOR MORE INFORMATION

Smart Choices Program, Planning and Policy Services Branch
 Planning and Development Department
 6th Floor, 10250 - 101 Street N.W. Edmonton, AB T5J 3P4
 PHONE (780) 496-6238 FAX (780) 401-7066
 www <http://www.edmonton.ca/smartchoices>



Duplexes

Planning and Design Guidelines for Residential Infill in Mature Neighbourhoods

Notes on Using the Infill Guidelines

These Infill Guidelines for Duplexes are part of an overall set of Residential Infill Guidelines. In reviewing these Guidelines, the following sections of the complete Residential Infill Guidelines document should also be consulted:

1. Section B, Objectives for Residential Infill;
2. Section D, General Guidelines for Residential Infill in Edmonton's Mature Neighbourhoods; and,
3. Section J, Implementation of the Residential Infill Guidelines.

In addition, other regulations established by the City of Edmonton may apply, including:

1. The City of Edmonton Zoning Bylaw, including the Mature Neighbourhood Overlay;
2. Any Area Redevelopment Plan that may be in place which establishes specific requirements.

These Residential Infill Guidelines, together with other regulations, will determine whether or not a Duplex will be permitted and will establish any specific requirements that may need to be addressed before it can be approved.

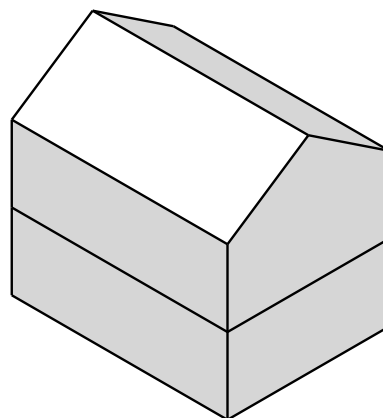

E6

Duplexes are one building containing two dwelling units, with one dwelling unit placed over the other. They are often referred to as “Up and Down Duplexes”.

These buildings are very similar in scale to a Single Detached dwelling and with appropriate design can be readily integrated into the neighbourhood.



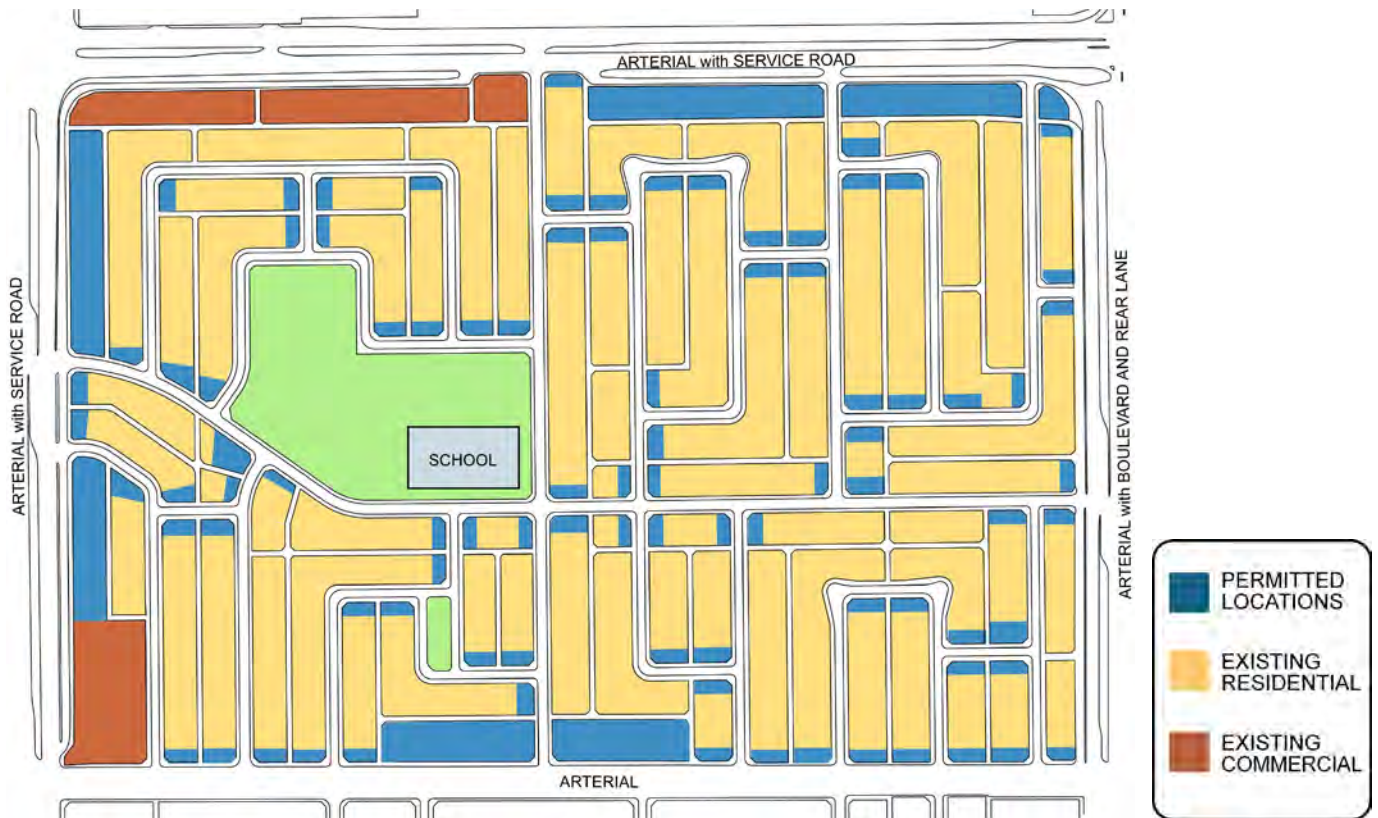

Location + Distribution

1. Duplexes may be located in the following areas:
 - a. On any corner site throughout a neighbourhood;
 - b. On a lot between two existing duplexes;
 - c. On the edge of a neighbourhood, where the lot fronts or flanks onto an arterial or service road;
 - d. On large sites that are being developed as part of a comprehensive plan.
2. Duplexes should have direct access to a lane from which parking can be accessed.



Built Form + Design

1. To minimize visual impact on and maximize integration with the existing neighbourhood, Duplexes should:
 - a. Use quality, durable building materials that are similar or complimentary to those found within the neighbourhood;
 - b. Be in proportion with homes found within the neighbourhood; and,
 - c. Incorporate fundamental design elements found within the neighbourhood.
2. Massing and placement of the building should be designed to avoid overlook and privacy concerns, and to optimize access to sunlight on adjacent and abutting properties.
3. The privacy of adjacent dwellings should be maintained through careful placement of windows, doors, decks, and patios.

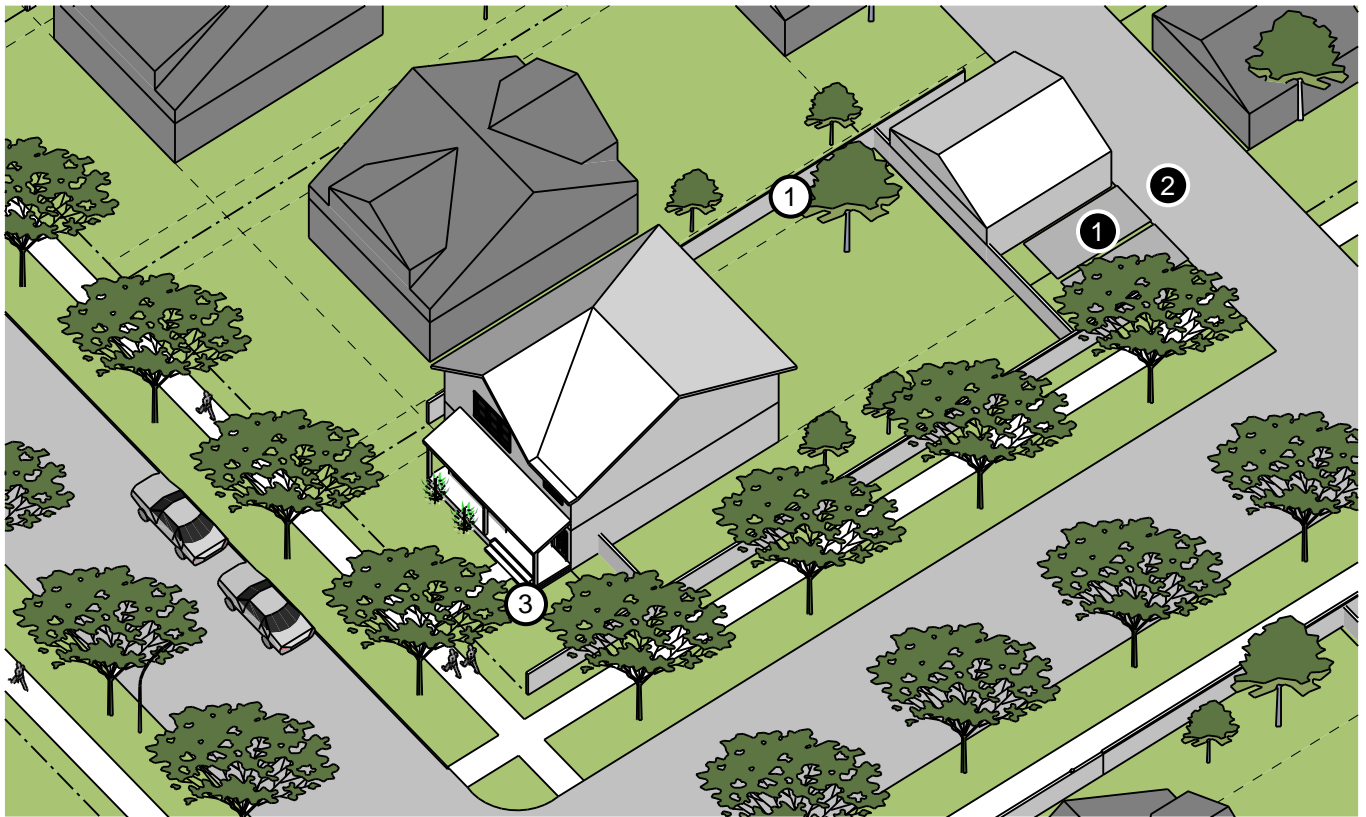

Site Design + Streetscape

①

1. An assessment of mature trees on the site should be provided and should describe how these trees will be retained.
2. The privacy of adjacent homes should be maintained through the use of fencing, screening, and landscaping.
3. At least one unit should have front door access to the street.

Parking

①

1. Sufficient onsite parking should be provided as required by the Zoning Bylaw.
2. Parking should be accessed from the adjacent lane.

FOR MORE INFORMATION

Smart Choices Program, Planning and Policy Services Branch
 Planning and Development Department
 6th Floor, 10250 - 101 Street N.W. Edmonton, AB T5J 3P4
 PHONE (780) 496-6238 FAX (780) 401-7066
 www <http://www.edmonton.ca/smartchoices>

Fourplexes

Planning and Design Guidelines for Residential Infill in Mature Neighbourhoods

Notes on Using the Infill Guidelines

These Infill Guidelines for Fourplexes are part of an overall set of Residential Infill Guidelines. In reviewing these Guidelines, the following sections of the complete Residential Infill Guidelines document should also be consulted:

1. Section B, Objectives for Residential Infill;
2. Section D, General Guidelines for Residential Infill in Edmonton's Mature Neighbourhoods; and,
3. Section J, Implementation of the Residential Infill Guidelines.

In addition, other regulations established by the City of Edmonton may apply, including:

1. The City of Edmonton Zoning Bylaw, including the Mature Neighbourhood Overlay;
2. Any Area Redevelopment Plan that may be in place which establishes specific requirements.

The Residential Infill Guidelines, together with other regulations, will determine whether or not a Fourplex will be permitted and will establish any specific requirements that may need to be addressed before it can be approved.

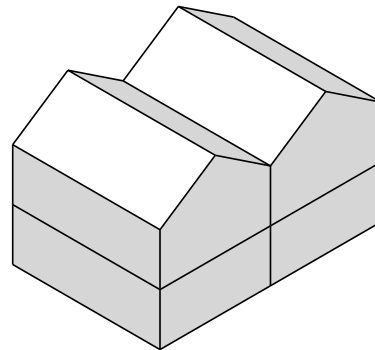

E7

The Fourplex, a form of Stacked Row Housing or Apartment Housing, is an arrangement of four dwelling units two deep, either vertically so that dwelling units may be placed over others, or back to back so that dwellings may be attached at the rear as well as at the side. Each dwelling has individual access to the street.

From the street, a well designed Fourplex appears similar to a Semi Detached dwelling. However, because of their larger mass, number of dwelling units and greater site coverage, Fourplexes are most appropriately located on the edge of neighbourhoods.

The typical means of creating a developable Fourplex site is to consolidate two small lots, or to develop on an existing large lot.



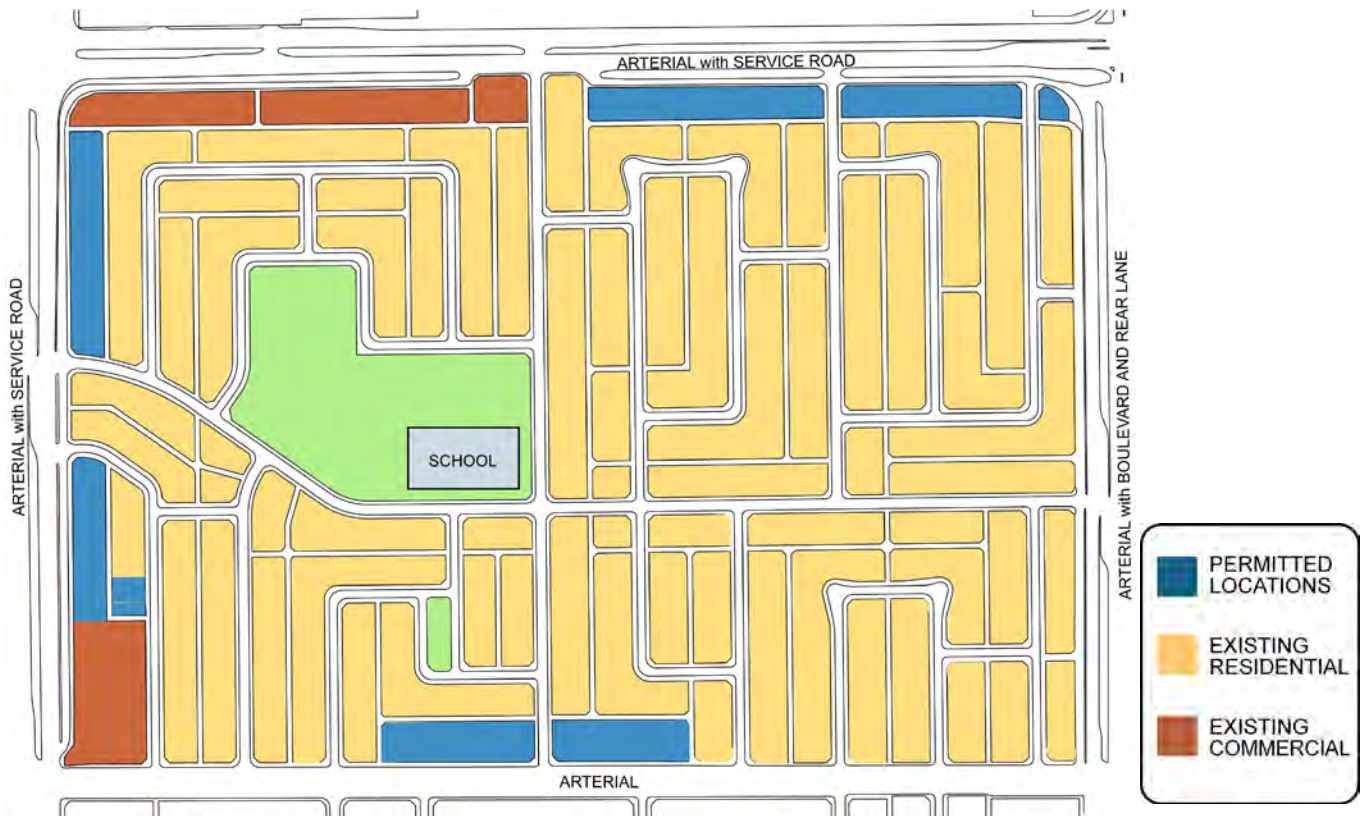

Location + Distribution

1. Fourplexes may be located in the following areas:
 - a. On the edge of a neighbourhood, where the block face fronts onto an arterial or service road;
 - b. On a lot between two existing Fourplexes;
 - c. On lots flanking commercial or apartment sites;
 - d. On any corner sites in neighbourhoods presently zoned RF3.
2. The building should have direct access to a lane or service road from which parking can be accessed.



Built Form + Design

1. To minimize visual impact on and maximize integration with the existing neighbourhood, Fourplexes should:
 - a. Either be designed with an asymmetric balance in the building form, proportion, and distribution of openings such that the units do not “mirror” each other; or,
 - b. Be designed so that each unit has significant architectural features (rooflines, front entrances, windows, and design details) that distinguish it from the other units; and,
 - c. Be constructed with durable, quality building materials that are similar or complimentary to those found within the neighbourhood;
 - d. Be in proportion with existing homes within the neighbourhood; and,
 - e. Incorporate fundamental design elements found within the neighbourhood.
2. Massing and placement of the building should be designed to avoid overlook and privacy concerns, and to optimize access to sunlight on adjacent properties.
3. The privacy of adjacent dwellings should be maintained through careful placement of windows, doors, decks, and patios.
4. Each unit should have an easily identifiable access to the fronting street.



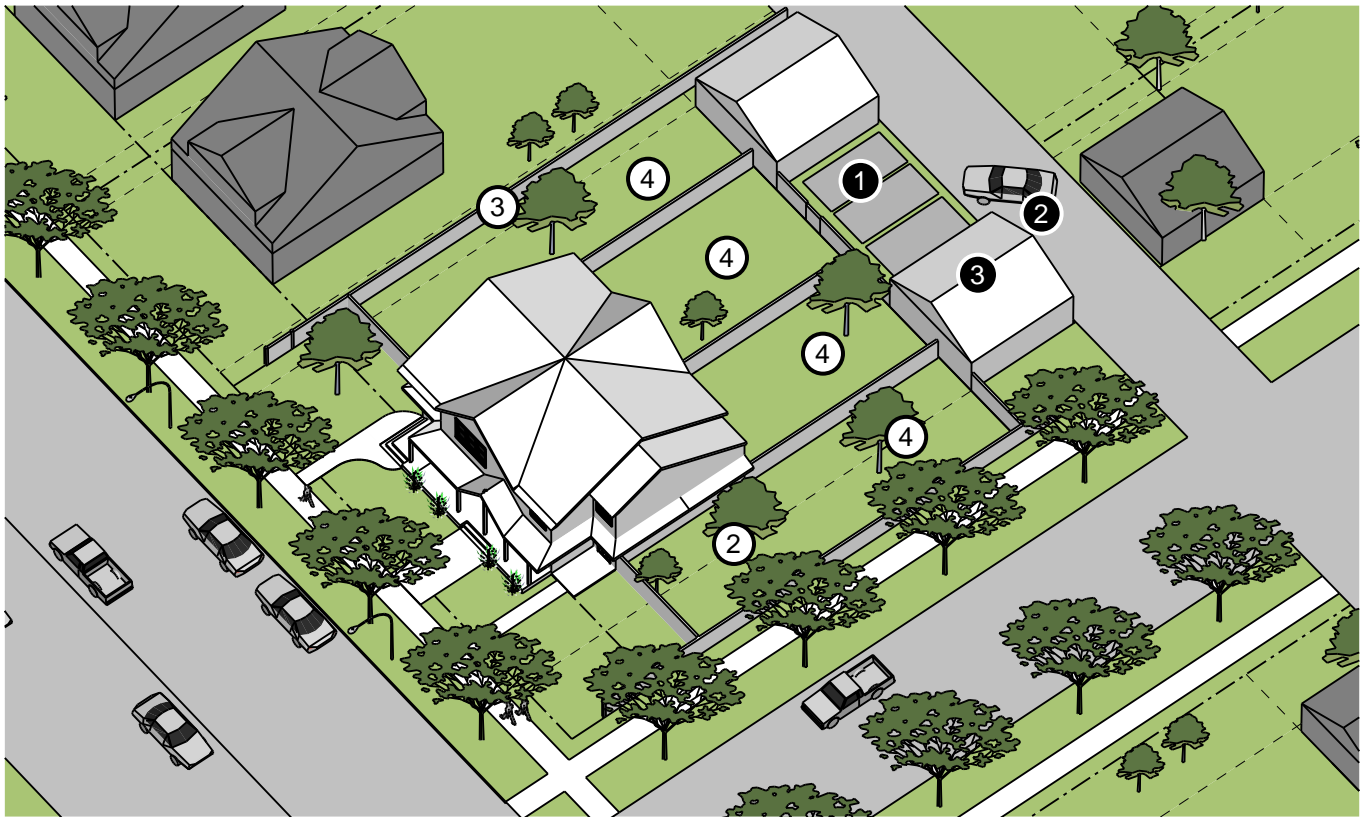

Site Design + Streetscape

- ①
1. The site should be landscaped in accordance with an approved Landscape Plan.
 2. The Landscape Plan should:
 - a. Include an assessment of mature trees on the site; and,
 - b. Provide for their retention to the greatest extent possible.
 3. The site design should maintain the privacy of adjacent homes through the use of fencing, screening, and landscaping.
 4. Each unit should have access to private onsite, outdoor amenity space.

Parking

- ①
1. Sufficient onsite parking should be provided as required by the Zoning Bylaw.
 2. Parking should be accessed from the adjacent lane.
 3. A parking garage should not exceed 8 metres in width.
 4. Parking garages should:
 - a. Be separated by a minimum of 1.5 metres; and,
 - b. Not adversely impact private, onsite amenity space.

FOR MORE INFORMATION

Smart Choices Program, Planning and Policy Services Branch
 Planning and Development Department
 6th Floor, 10250 - 101 Street N.W. Edmonton, AB T5J 3P4
 PHONE (780) 496-6238 FAX (780) 401-7066
 www <http://www.edmonton.ca/smartchoices>

Row Housing (UP TO 5)

Planning and Design Guidelines for Residential Infill in Mature Neighbourhoods

Notes on Using the Infill Guidelines

These Infill Guidelines are part of an overall set of Planning and Design Guidelines for Residential Infill in Mature Neighbourhoods. In reviewing these Guidelines for Small Scale Row Houses, the following sections of the overall “Infill Guidelines” should also be consulted:

1. Section B, Objectives for Residential Infill;
2. Section D, General Guidelines for Residential Infill in Edmonton’s Mature Neighbourhoods; and,
3. Section J, Implementation of the Residential Infill Guidelines.

In addition, other regulations established by the City of Edmonton may apply:

1. The City of Edmonton Zoning Bylaw, including the Mature Neighbourhood Overlay;
2. An Area Redevelopment Plan may be in place which establishes specific requirements.

These Residential Infill Guidelines, together with the other plans and regulations, will determine whether or not a Small Scale Row House development will be permitted and will establish any specific requirements that may need to be addressed before it can be approved.

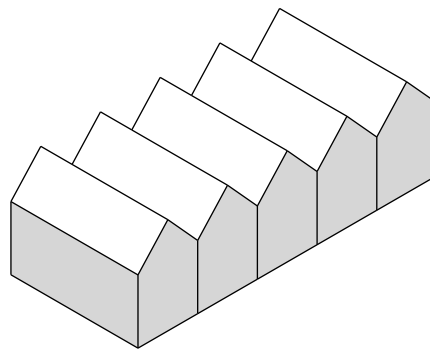

E8

Row Houses are buildings containing three or more dwellings joined at the side only by a party wall. They have a maximum height of 2 ½ storeys, and no dwellings are placed over another. Each dwelling has individual and direct access to the street and typically contains some private open space in front and back. Row Houses of up to and including five units are considered to be “Small Scale Residential Infill”.

Small Scale Row House developments, when well designed, are compatible with single detached housing. Row Houses also provide an adaptable, comparatively affordable form of housing that may be suitable for families with children, and which is more readily accepted as a form of residential infill by existing neighbourhoods.



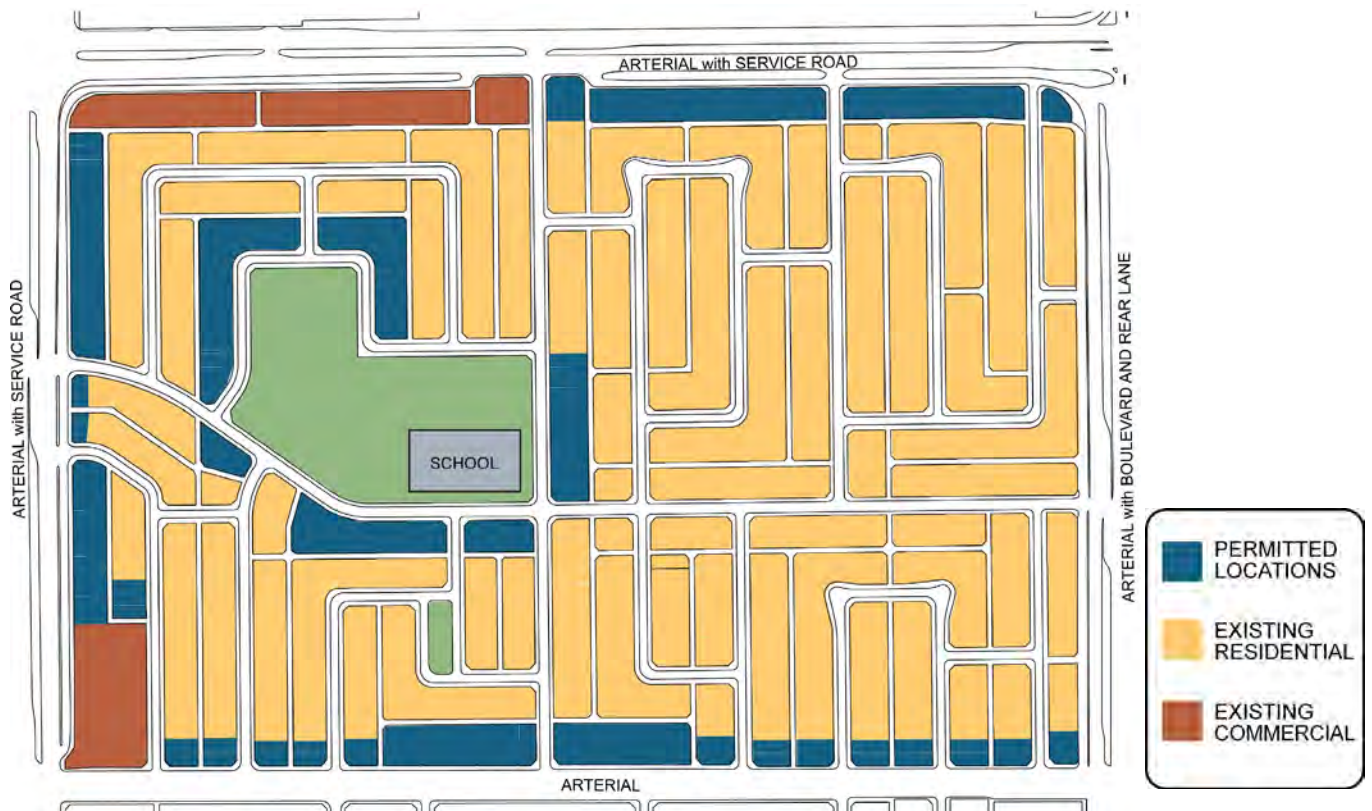

Location + Distribution

1. Small Scale Row Houses of five units or less may be located:
 - a. On the edges of the neighbourhood, where the block face fronts onto an arterial or service road;
 - b. On lots that flank onto an arterial or service road, providing that frontage on the primary local street does not exceed 30 metres.
 - c. Directly across from and fronting neighbourhood school or park sites, except in neighbourhoods where there is a large site within the interior of the neighbourhood that may be redeveloped to include row housing or where zoning for low rise apartments already extends one block or more beyond the
 - d. perimeter arterials into the interior of the neighbourhood;
 - e. On sites flanking commercial sites and apartments;
 - f. On corner sites in neighbourhoods that are zoned RF3;
 - g. On large sites within mature neighbourhoods for which comprehensive plans have been prepared.
2. All Row House units should have direct access to a lane or service road from which parking can be accessed.
3. Small Scale Row Houses should not front onto a flanking street, except where the flanking street is an arterial roadway or service road.





Built Form + Design

1. To minimize visual impact on and maximize integration with the existing neighbourhood Small Scale Row Houses should:
 - a. Incorporate fundamental design elements and proportions found within the neighbourhood; and,
 - b. Be constructed with durable, quality materials which are similar or complimentary to those found within the neighbourhood.
2. Building mass should be arranged to minimize shadowing and to optimize access to sunlight on adjacent properties.
3. Privacy of adjacent dwellings should be maintained through careful placement of windows, doors and patios.
4. Façades should be designed to articulate the individual units in keeping with surrounding single detached character. This may be accomplished by:
 - a. Using a three dimensional recess or projection that highlights the identity of the individual units at the point where dwelling units are separated internally; and,
 - b. Using entrance features, roofline features, or other architectural elements.
5. Total building length for a Small Scale Row House development should not exceed 48 metres.
6. Each unit should have individual front door access to the street.
7. Row Housing units that are developed on flanking lots should be designed to “address” both the flanking and fronting streets.



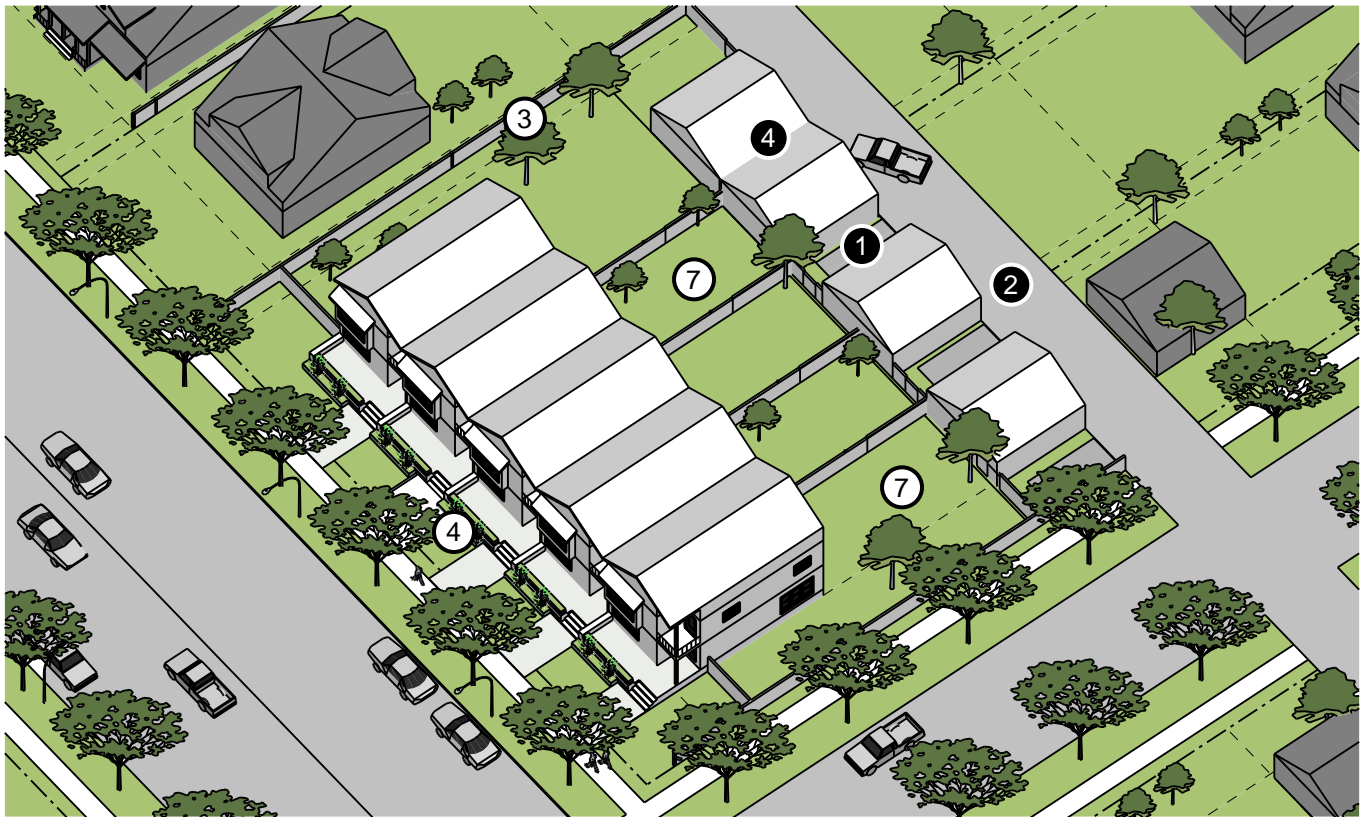

Site Design + Streetscape

0

1. The site should be landscaped in accordance with an approved Landscape Plan.
2. The Landscape Plan should:
 - a. Include an assessment of mature trees on the site; and,
 - b. Provide for their retention to the greatest extent possible.
3. The site design should contribute to the privacy of adjacent homes through the use of fencing, screening and landscaping.
4. All Small Scale Row Houses should be oriented toward the primary fronting street.
5. Where Row Housing is developed on flanking lots, the lot should have an adequate width (min. 20m) to provide each unit with a private outdoor amenity area, and to maintain privacy and sunlight on the adjacent property.
6. A generally similar unit form should not be repeated more than five times on a block front.
7. Private outdoor amenity space, preferably located at the rear of the unit, should be available to all units.
8. Minimum setbacks and yard requirements should not be relaxed next to arterials.

Parking

0

1. Sufficient onsite parking should be provided for all units as required by the Zoning Bylaw.
2. Parking should be accessed from the adjacent lane.
3. Parking should be provided at the rear of the building.
4. A parking garage should not exceed 12 metres in width.

FOR MORE INFORMATION

Smart Choices Program, Planning and Policy Services Branch
 Planning and Development Department
 6th Floor, 10250 - 101 Street N.W. Edmonton, AB T5J 3P4
 PHONE (780) 496-6238 FAX (780) 401-7066
 www <http://www.edmonton.ca/smartchoices>



Row Housing (6+)

Planning and Design Guidelines for Residential Infill in Mature Neighbourhoods

Using the Residential Infill Guidelines

These Guidelines are part of an overall set of Planning and Design Guidelines for Residential Infill in Mature Neighbourhoods. In reviewing these Guidelines for Medium Scale Row Houses, the following sections of the overall Infill Guidelines should also be consulted:

1. Section B, Objectives for Residential Infill;
2. Section D, General Guidelines for Residential Infill in Edmonton's Mature Neighbourhoods; and,
3. Section J, Implementation of the Residential Infill Guidelines.

In addition, other regulations established by the City of Edmonton may apply, including:

1. The City of Edmonton Zoning Bylaw, including the Mature Neighbourhood Overlay;
2. An Area Redevelopment Plan may be in place which establishes specific requirements.

These Residential Infill Guidelines, together with the other plans and regulations, will determine whether or not a Medium Scale Row House development will be permitted and will establish any specific requirements that may need to be addressed before it can be approved.

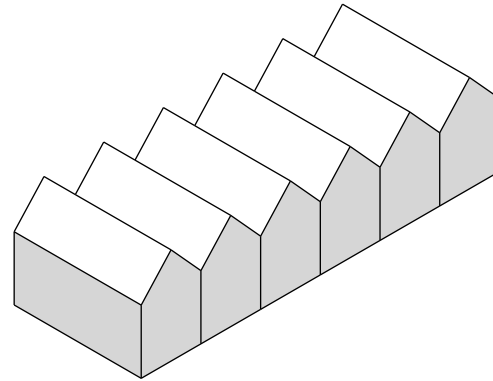

F1

Row Houses are buildings containing three or more dwellings joined at the side only by a party wall. Row Houses are generally 2 ½ storey buildings and no dwellings are placed over another. Each dwelling has individual and direct access to the street, is oriented to the street, and has some private open space in front and back. Row House developments of six or more units are considered to be “Medium Scale Residential Infill”.

Medium Scale Row House developments provide an adaptable, comparatively affordable form of housing that may be suitable for families with children and which is more readily accepted as a form of residential infill by existing neighbourhoods. Row Houses provide a good transition between Large Scale and Small Scale development

FOR MORE INFORMATION

Smart Choices Program,
Planning and Policy Services Branch
Planning and Development Department
6th Floor, 10250 - 101 Street N.W.
Edmonton, AB T5J 3P4
PHONE (780) 496-6238 FAX (780) 401-7066
www <http://www.edmonton.ca/smartchoices>



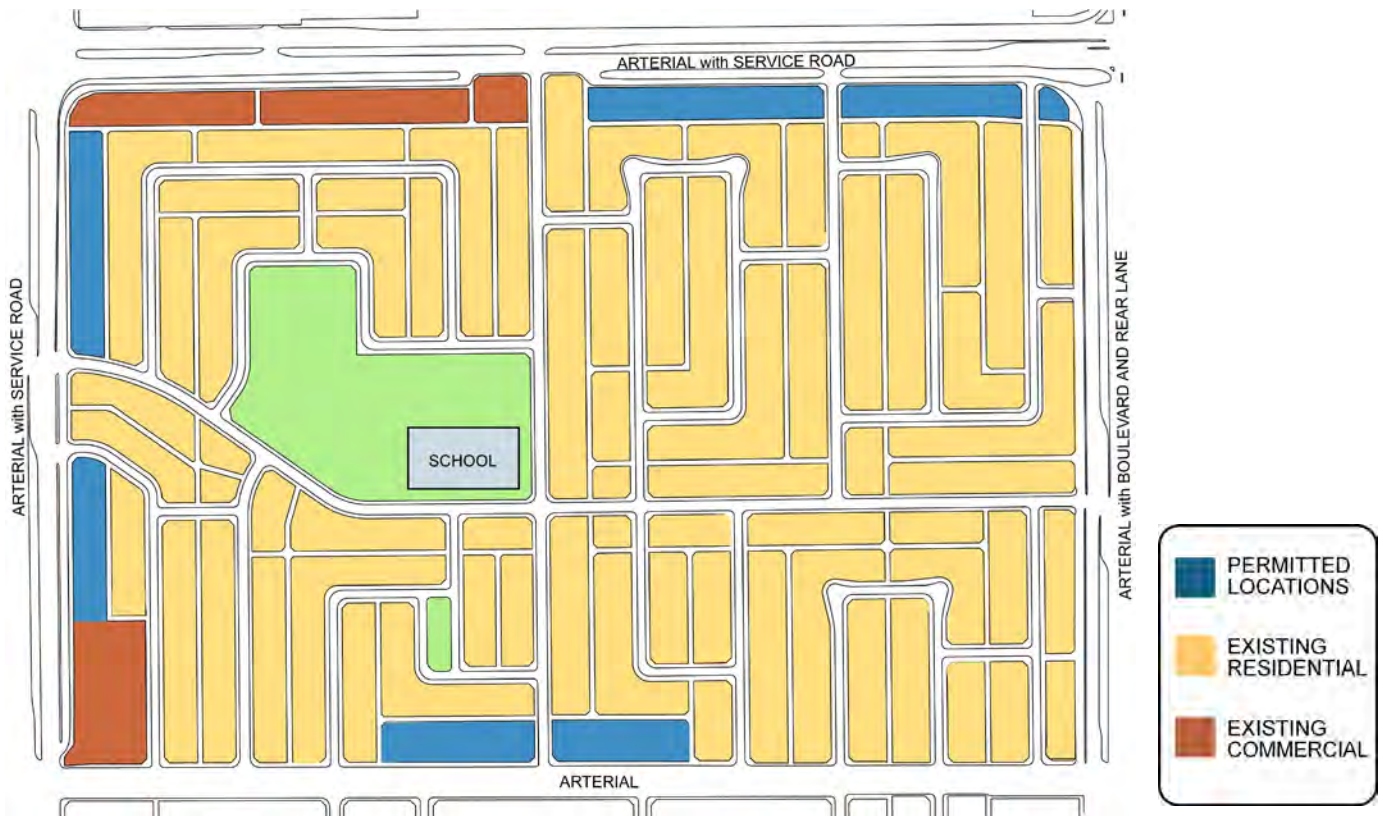

Location + Distribution

1. Medium Scale Row House developments of six or more units may be located in the following areas:
 - a. On the edge of the neighbourhood where the block face fronts onto an arterial or service road;
 - b. On existing regional or community level shopping centre sites;
 - c. On school sites within the neighbourhood that have been declared surplus;
 - d. On large sites within mature neighbourhoods for which comprehensive plans have been prepared.
 - e. On high frequency transit corridors as identified in the Transportation Master Plan.





Built Form + Design

1. Building mass should be arranged to minimize shadowing and to optimize access to sunlight for units on site and on adjacent properties.
2. To minimize visual impact on and maximize integration with the existing neighbourhood, Row Houses should:
 - a. Incorporate fundamental design elements, proportions, and character found within the neighbourhood; and,
 - b. Be constructed with durable, quality materials similar or complimentary to those found within the neighbourhood.
3. The maximum building length of Row Houses should be no more than 48 metres, permitting views through the site and limiting mass along the block face.
4. Façades should be designed to articulate the individual units in keeping with surrounding single detached character. This may be accomplished by:
 - a. Using a three dimensional recess or projection that highlights the identity of the individual units at the point where dwelling units are separated internally; and,
 - b. Using entrance features, roofline features, or other architectural elements.
5. The building should front onto a street.
6. Each unit should have individual front door access to the street.
7. All units should be designed to have easy access to outdoor, ground level amenity space.
8. The privacy of units on site and on adjacent properties should be maintained by minimizing overlook from the building through:
 - a. Setbacks and articulation of the building; and,
 - b. Careful placement of windows, doors and patios.



Site Design + Streetscape

0

1. The site should be landscaped in accordance with an approved Landscape Plan.
2. The Landscape Plan should:
 - a. Include an assessment of mature trees on site;
 - b. Provide for the retention of mature trees to the greatest extent possible; and,
 - c. Incorporate the design and planting of public sidewalk and boulevard areas adjacent to the site.
3. The site design should, in concert with the design of the building, contribute to the sense of privacy of adjacent homes through the use of fencing, screening and landscaping.
4. Upgrading of adjacent public sidewalks and boulevard areas may be a requirement of development approval.
5. Row House developments should maintain streetscapes that are compatible with existing development by:
 - a. Providing individual front entrances and landscaped yards; and,
 - b. Defining individual units through such features as the design of roof lines, entrances, and building materials.
6. Buildings should be developed with entry transitions (e.g. use of steps, fences, gates, hedges, low walls) and semi-private outdoor

spaces that create a comfortable relationship between the public realm of the street and the private space of the dwelling units.

7. A generally similar unit form and design should not be repeated more than six times on a block front.
8. Minimum setbacks and yard requirements should not be relaxed adjacent to arterials.

Parking

0

1. Sufficient onsite parking should be provided for all units as required by the Zoning Bylaw.
2. Parking should be provided at the rear of the buildings.
3. Parking should be accessed from the adjacent lane.
4. Parking garages should not exceed 12 metres in width.

Stacked Row Housing

Planning and Design Guidelines for Residential Infill in Mature Neighbourhoods

Using the Residential Infill Guidelines

These Guidelines are part of an overall set of Planning and Design Guidelines for Residential Infill in Mature Neighbourhoods. In reviewing these Guidelines for Stacked Row Housing, the following sections of the overall Infill Guidelines should also be consulted:

1. Section B, Objectives for Residential Infill;
2. Section D, General Guidelines for Residential Infill in Edmonton's Mature Neighbourhoods; and,
3. Section J, Implementation of the Residential Infill Guidelines.

In addition, other regulations established by the City of Edmonton may apply, including:

1. The City of Edmonton Zoning Bylaw, including the Medium Density Overlay;
2. An Area Redevelopment Plan may be in place which establishes specific requirements.

These Residential Infill Guidelines, together with the other plans and regulations, will determine whether or not a Stacked Row House development will be permitted and will establish any specific requirements that may need to be addressed before it can be approved.

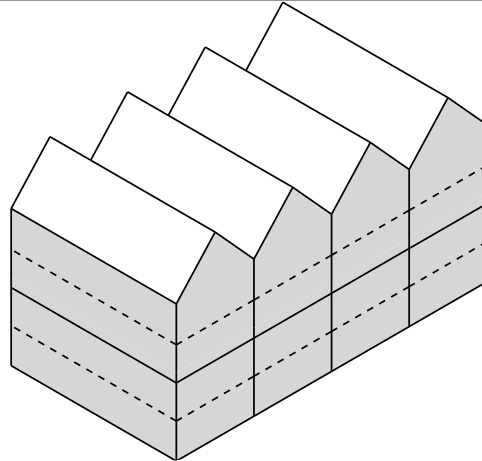

F2

Stacked Row Houses are a form of row housing where five or more dwellings are arranged two deep, either placed vertically with one over another or horizontally with one or more attached at the rear or at the side. Typically, each dwelling has individual and direct access to the street and access to private open space. Stacked Row Houses are considered to be “Medium Scale Residential”.

Stacked Row Houses can have the appearance of a Low Rise Apartment building, but the requirement for access to the street makes it a more suitable form of housing for families.

FOR MORE INFORMATION

Smart Choices Program,
Planning and Policy Services Branch
Planning and Development Department
6th Floor, 10250 - 101 Street N.W.
Edmonton, AB T5J 3P4
PHONE (780) 496-6238 FAX (780) 401-7066
www <http://www.edmonton.ca/smartchoices>



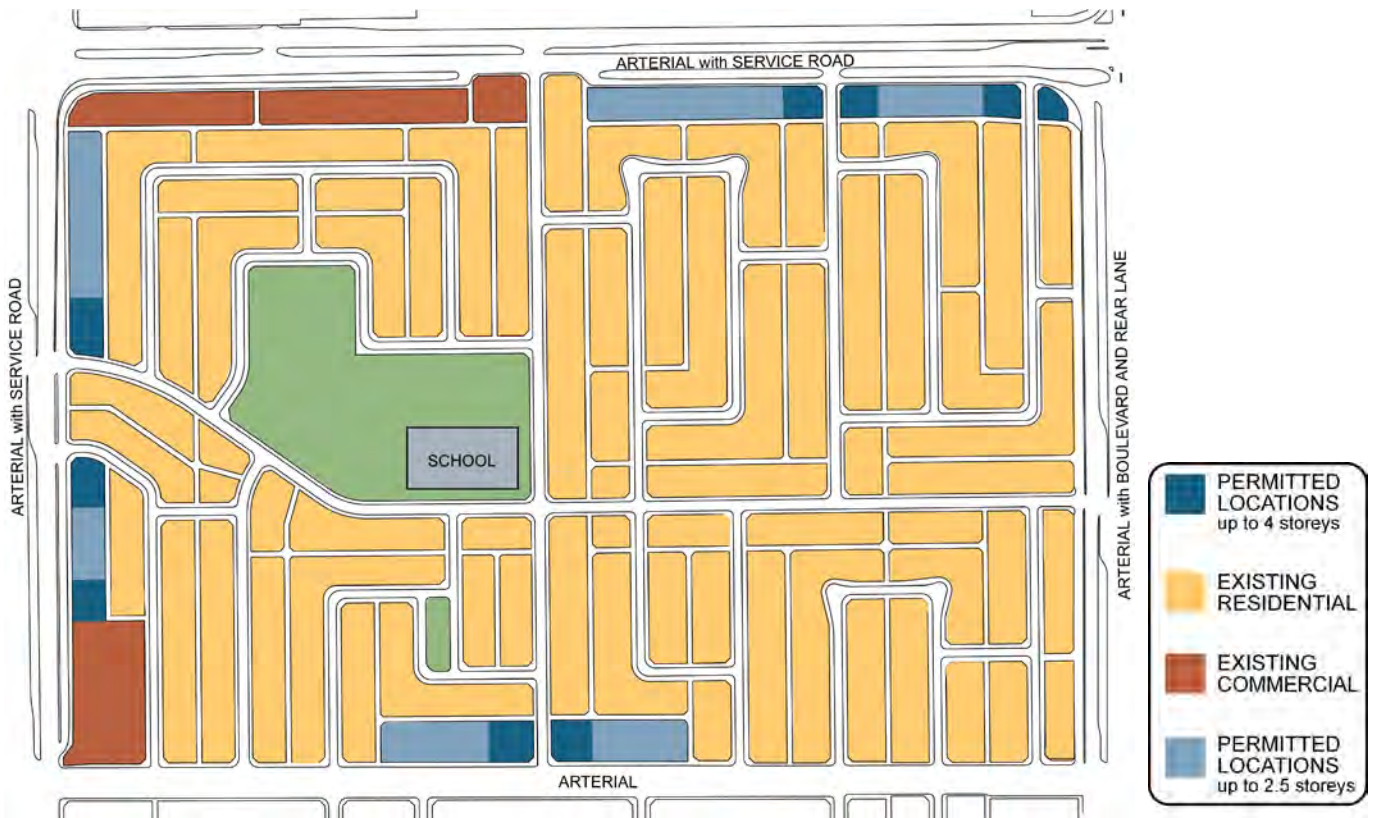

Location + Distribution

1. Stacked Row House developments may be located in the following areas:
 - a. On corner sites on the edge of the neighbourhood where the block face fronts onto an arterial or service road;
 - b. On existing regional or community level shopping centre sites;
 - c. On sites that are adjacent to community or neighbourhood commercial centres where the block face fronts onto an arterial or service road;
 - d. On large sites within mature neighbourhoods for which comprehensive plans have been prepared.
- e. On high frequency transit corridors as identified in the Transportation Master Plan.
- f. On the edge of the neighbourhood, where the block face fronts onto an arterial or service road, providing that the height does not exceed 2.5 storeys and the density and building envelope does not exceed the requirements of the RF5 (Row Housing) Zone.
2. The building should have direct access to a lane from which parking can be accessed.
3. The maximum lot frontage for a Stacked Row House development on a corner site or site adjacent to a community or neighbourhood commercial centre should be 46 metres.





Built Form + Design

1. The maximum height of Stacked Row Houses should be four storeys; habitable basement development and lofts each count as one storey.
2. On sites abutting a Single Detached, Semi Detached or Row Housing zone, the height of the building adjacent to the side yard should be stepped down to the maximum height permitted in the adjacent zone.
3. Building mass should be arranged to minimize shadowing and to permit access to sunlight on adjacent properties.
4. To minimize visual impact on and maximize integration with the existing neighbourhood, Stacked Row Houses should:
 - a. Incorporate fundamental design elements, proportions, and character found within the neighbourhood; and,
 - b. Be constructed with durable, quality materials similar or complimentary to those found within the neighbourhood.
5. The maximum building length of Stacked Row Houses should be no more than 48 metres, permitting views through the site and limiting building mass along the block face.
6. Façades should be designed to articulate the individual units in keeping with surrounding Single Detached character. This may be accomplished by:
 - a. Punctuating the façade at a maximum of each eight metres along the building frontage with an indentation no less than two metres wide and two metres deep; and,
 - b. Using entrance features, roofline features, or other architectural elements.
7. The building should front onto a street.
8. Each unit should have individual front door access to the street.
9. The privacy of units on site and on adjacent properties should be maintained by minimizing overlook from the building through:
 - a. Setbacks and articulation of the building; and,
 - b. Careful placement of windows, doors and patios.
10. All units should have access to outdoor, ground level amenity space.

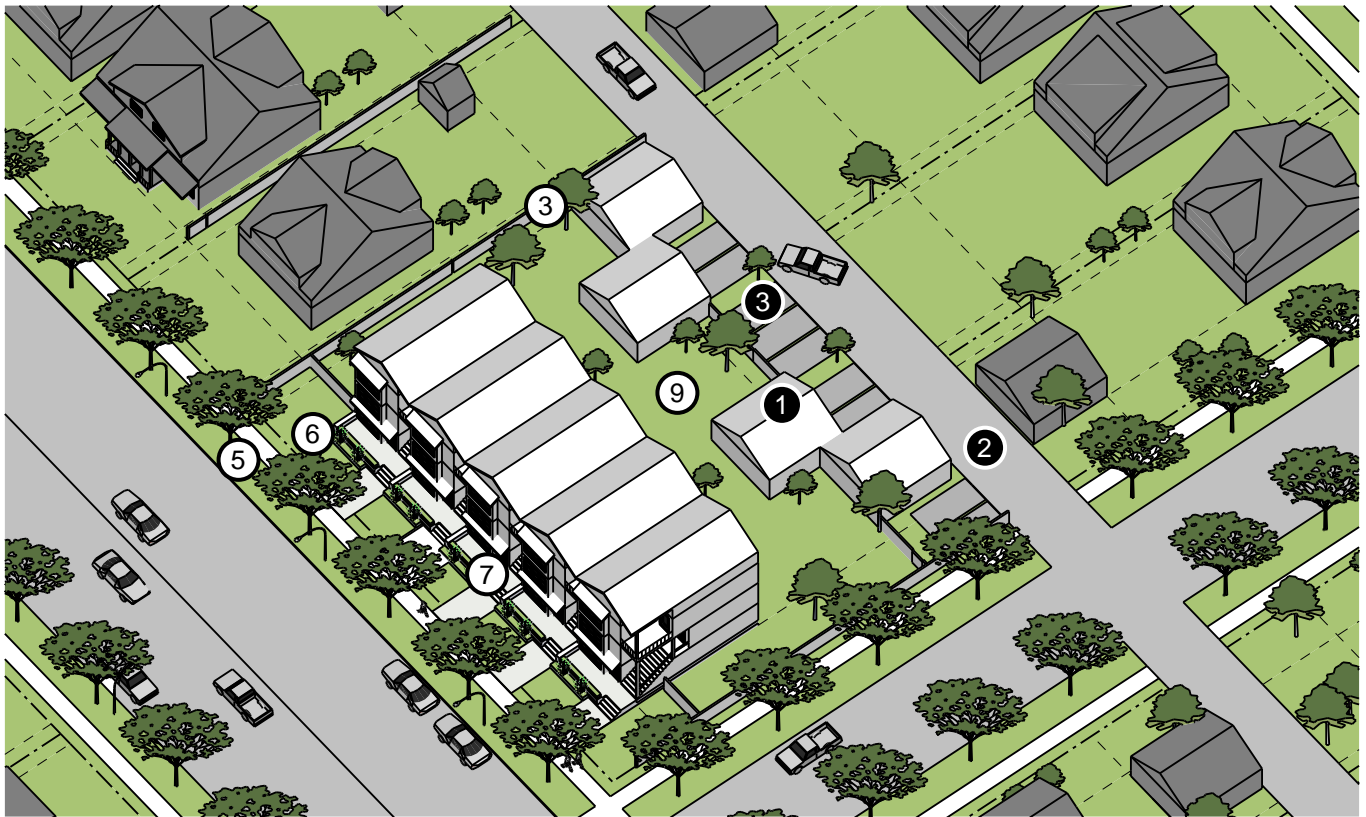

Site Design + Streetscape

- 0 The site should be landscaped in accordance with an approved Landscape Plan.
- 1 The Landscape Plan should:
 - a. Include an assessment of mature trees on site;
 - b. Provide for the retention of mature trees to the greatest extent possible; and,
 - c. Incorporate the design and planting of public sidewalk and boulevard areas adjacent to the site.
 - d. Illustrate the landscaping of yards and common outdoor amenity areas.
- 2 The site design should, in concert with the design of the building, maintain the privacy of adjacent homes through careful placement of outdoor amenity areas, and the use of fencing, screening and landscaping.
- 3 The site design should, in concert with the design of the building, optimize access to sunlight on adjacent properties.
- 4 Upgrading of the adjacent public sidewalks and boulevard areas may be a requirement of development approval.
- 5 Stacked Row House infill developments should maintain streetscapes that are compatible with existing development by:
 - a. Providing individual front entrances and landscaped yards; and,
 - b. Defining individual units through such features as the design of roof lines, entrances, and building materials.
- 6 The buildings should be developed with entry transitions (e.g. use of steps, fences, gates, hedges, low walls) and semi-private outdoor spaces that create a comfortable relationship between the public realm of the street and the private space of the dwelling units.
- 7 A generally similar unit form should not be repeated more than six times on a block front.
- 8 A common outdoor amenity area should be provided on site, and be designed to create a comfortable, attractive passive recreational area for residents.

Parking

- 0 All parking should be provided on site.
- 1 Parking should be accessed from the adjacent lane.
- 2 Parking may be provided as surface parking but all surface parking areas should:
 - a. Be broken into segments so that there is not one continuous hard surface area;
 - b. Be landscaped to provide aesthetic relief and shade; and,
 - c. Not preclude the development of a well designed outdoor amenity space.
- 3 Surface parking should be provided at the rear of the building.

Low Rise Apartments

Planning and Design Guidelines for Residential Infill in Mature Neighbourhoods

Using the Residential Infill Guidelines

These Guidelines are part of an overall set of Planning and Design Guidelines for Residential Infill in Mature Neighbourhoods. In reviewing these Guidelines for Low Rise Apartments, the following sections of the overall Infill Guidelines should also be consulted:

1. Section B, Objectives for Residential Infill;
2. Section D, General Guidelines for Residential Infill in Edmonton's Mature Neighbourhoods; and,
3. Section J, Implementation of the Residential Infill Guidelines.

In addition, other regulations established by the City of Edmonton may apply, including:

1. The City of Edmonton Zoning Bylaw, including the Medium Density Overlay;
2. An Area Redevelopment Plan may be in place which establishes specific requirements.

These Residential Infill Guidelines, together with the other plans and regulations, will determine whether or not a Low Rise Apartment development will be permitted and will establish any specific requirements that may need to be addressed before it can be approved.

FOR MORE INFORMATION

Smart Choices Program,
Planning and Policy Services Branch
Planning and Development Department
6th Floor, 10250 - 101 Street N.W.
Edmonton, AB T5J 3P4
PHONE (780) 496-6238 FAX (780) 401-7066
www <http://www.edmonton.ca/smartchoices>

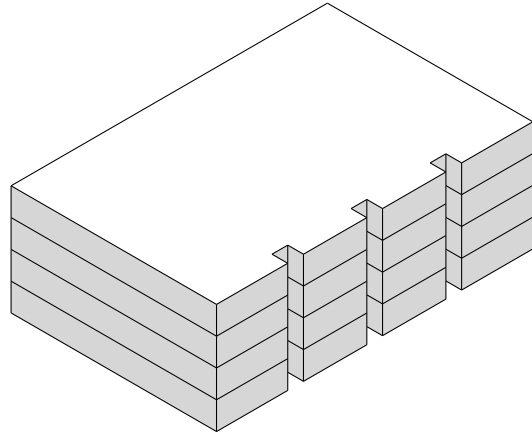

F3

Low Rise Apartments are three to four storey buildings that are designed in a variety of different configurations, depending upon the size and context of the site to be redeveloped. These buildings will normally contain many dwelling units that share a ground level entrance and share amenity space within the building or on the property.

Traditionally known in Edmonton as “Walk Up Apartments”, they are found in many mature neighbourhoods and were typically constructed as smaller buildings taking up only one or two lots and with no more than three storeys. More recent versions of Low Rise Apartments are often much larger and up to 5 ½ storeys high, which is not compatible with the smaller scale of development in mature neighbourhoods. Low Rise Apartments are an important form of housing in the City; the following infill Guidelines seek to encourage this form of housing while ensuring that it remains compatible with the neighbourhoods in which it is located.



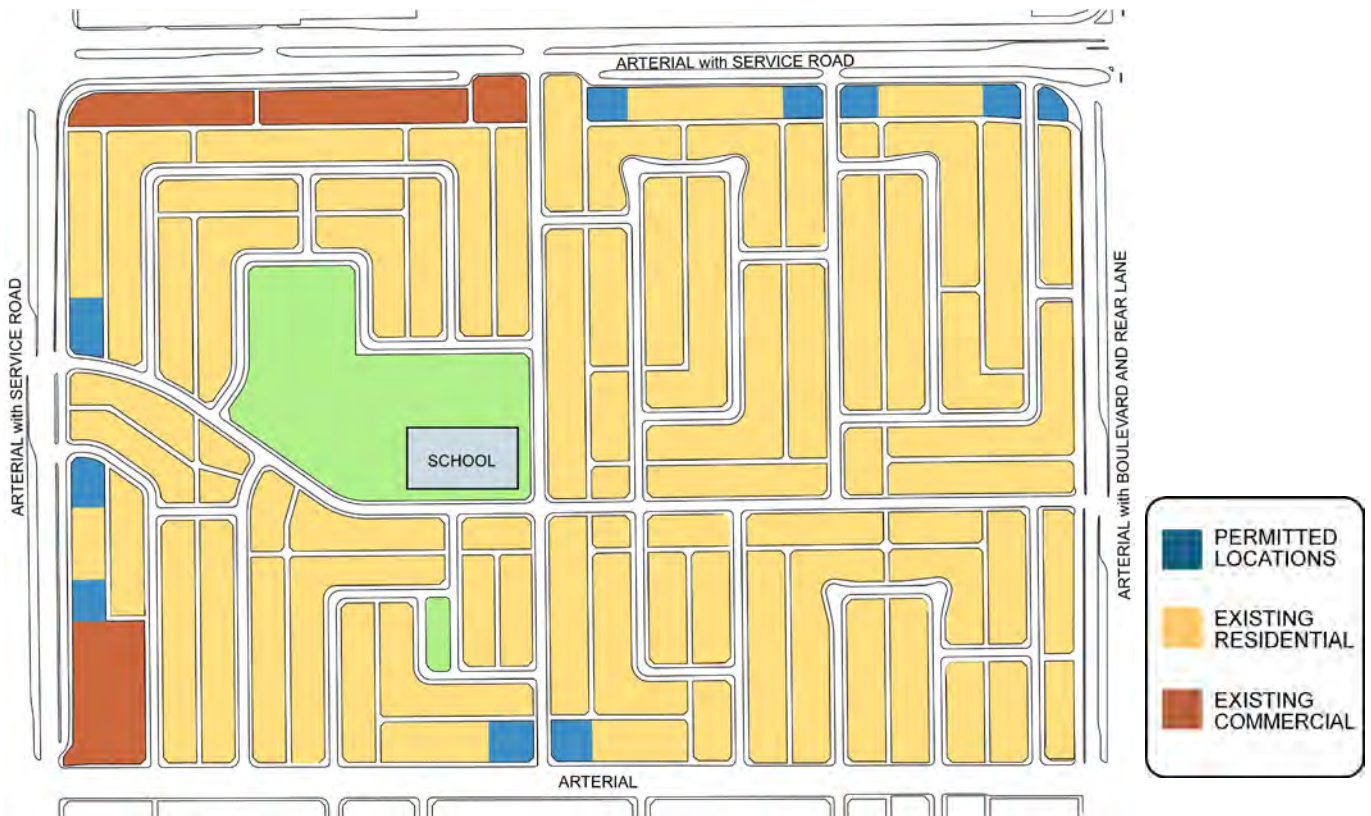

Location + Distribution

1. Low Rise Apartment infill developments may be located in the following areas:
 - a. On corner sites on the edge of the neighbourhood where the block face fronts onto an arterial or service road;
 - b. On existing regional or community level shopping centre sites;
 - c. On sites adjacent to neighbourhood commercial centres where the block face fronts onto an arterial or service road;
 - d. Along the full length of old commercial strips;
 - e. On Large Sites within mature neighbourhoods for which comprehensive plans have been prepared; or,
 - f. On high frequency transit corridors as identified in the Transportation Master Plan.
2. The maximum lot frontage for a Low Rise Apartment on a corner site or site adjacent to a commercial centre should be 46 metres.
3. The building should have direct access to a lane from which parking can be accessed.





Built Form + Design

1. The maximum height of a Low Rise Apartment should be four storeys; habitable basement development or lofts each count as one storey.
2. On sites abutting a Single Detached, Semi Detached or Row Housing zone, the height of the building adjacent to the side yard should be stepped down to the maximum height permitted in the adjacent zone.
3. To minimize visual impact on and maximize integration with the existing neighbourhood, Low Rise Apartments should:
 - a. Incorporate fundamental design elements, proportions, and character found within the neighbourhood; and,
 - b. Be constructed with durable, quality materials similar or complimentary to those found within the neighbourhood.
4. To optimize access to sunlight on adjacent properties, where a Low Rise Apartment building is proposed adjacent to a Single Detached Dwelling:
 - a. The building mass should be stepped back or articulated; or
 - b. The side yards should be increased.
5. The privacy of adjacent dwellings should be maintained by minimizing overlook from the building through:
 - a. Setbacks and articulation of the building; and,
 - b. Careful placement of windows, balconies, entrances and amenity areas.
6. The building should front onto a street.
7. The majority of ground level units with street frontage should have individual entrances that front onto a street. All other units should be accessed through a front entrance hall fronting onto a street.
8. Building facades should be modulated in plan and elevation and articulated to reduce the appearance of building bulk and to create visual interest. The building façade should be punctuated:
 - a. At a maximum of eight metres along the building frontage with an indentation no less than two metres wide and two metres deep; and,
 - b. At the primary street entrance to the building with an indentation of no less than two metres wide and two metres deep.
9. All units should have access to outdoor, ground level amenity space.
9. The maximum building length of Low Rise Apartments should be no more than 48 metres, permitting views through the site and limiting building mass along the block face.

Mid Rise Apartments

Planning and Design Guidelines for Residential Infill in Mature Neighbourhoods

Using the Residential Infill Guidelines

These Guidelines for Mid Rise Apartments are part of an overall set of Planning and Design Guidelines for Residential Infill in Mature Neighbourhoods. In reviewing these Guidelines, the following sections of the overall Residential Infill Guidelines should also be consulted:

1. Section B, Objectives for Residential Infill;
2. Section D, General Guidelines for Residential Infill in Edmonton's Mature Neighbourhoods; and,
3. Section H, Large Infill Site Guidelines; and,
4. Section J, Implementation of the Residential Infill Guidelines.

In addition, other regulations established by the City of Edmonton may apply, including:

1. The City of Edmonton Zoning Bylaw;
2. Any Area Redevelopment Plan that may be in place; and,
3. The Large Site Rezoning Process.

These Residential Infill Guidelines, together with the Large Site Infill Guidelines and other regulations, will determine whether or not a Mid Rise Apartment development will be permitted and will establish any specific requirements that may need to be addressed before it can be approved.

FOR MORE INFORMATION

Smart Choices Program,
 Planning and Policy Services Branch
 Planning and Development Department
 6th Floor, 10250 - 101 Street N.W.
 Edmonton, AB T5J 3P4
 PHONE (780) 496-6238 FAX (780) 401-7066
 www <http://www.edmonton.ca/smartchoices>

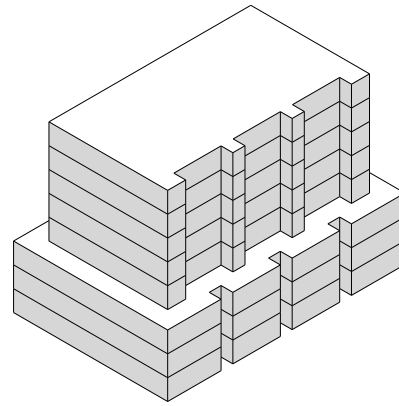

G1

Mid Rise Apartment buildings are five to eight storey buildings that are designed in a variety of different configurations, depending upon the size and context of the site to be redeveloped. These buildings contain many dwelling units that share a ground level entrance and share amenity space within the building or on the property. Given the large scale of Mid Rise Apartments, there is a need to deal with issues related to the context of the site, such as height, shadowing, urban design, traffic and parking, and these buildings should be constructed on sites where these issues can be readily addressed. Thus, the location and distribution of Mid Rise Apartment buildings will be governed primarily by the Large Infill Site Guidelines.

The location of Mid Rise residential buildings may be further restricted by other City policy, including the policy to direct high density development to the vicinity of LRT Stations and Transit Terminals (see the Large Infill Site guidelines, Section H). The height and density of residential infill on large sites that do not meet the transit oriented location criteria will be restricted unless the development of those sites provides specific City and neighbourhood benefits such as affordable housing, open space, recreational facilities, or other similar amenities.



Location + Distribution

1. Mid Rise Apartment buildings should locate in the City's key activity centres, including:
 - a. The central area of the city, including Downtown, the Station Lands and Downtown North Edge;
 - b. Areas adjacent to LRT Stations;
 - c. At existing regional or community level shopping centre sites.
2. Subject to the development being able to achieve the applicable Large Infill Site Guidelines, Mid Rise Apartment buildings may be located:
 - a. On Large Residential Infill Sites, which are defined generally as sites over one hectare in size;
 - b. On other sites where the specific context of the site warrants consideration of Mid Rise buildings such as on sites that have direct access to an arterial or collector road, and are isolated from small scale residential development by other land uses such as existing medium/large scale residential development, commercial development, a large park site or natural area.
3. The preferred locations for Mid Rise Apartment buildings may be further defined through an Area Redevelopment Plan, Transit Oriented Development (TOD) Plan, or Site Vision and Context Plan.
4. Mid Rise Apartment sites should have direct access to an arterial or collector road, or a road with the demonstrated capacity to accommodate the development without undue impact on adjacent areas.

Parking

1. Sufficient onsite parking for all units should be provided as required by the Zoning Bylaw.
2. All parking should be accessed from the adjacent lane.
3. Resident parking should be provided underground or in above ground parking structures.
4. Above ground parking structures should be fully screened with residential, commercial, or community uses to provide for active frontages.
5. Any surface visitor parking areas for Mid Rise Apartments should:
 - a. Be developed at the side or rear of the building;
 - b. Be separated from residential units by landscaped buffers;
 - c. Be accessed from the lane;
 - d. Cluster parking spaces and divide the clusters with landscaping; and,
 - e. Not impact the street or outdoor amenity areas.
6. The City should consider the relaxation of parking requirements for Mid Rise Apartments at TOD locations.





Built Form + Design

1. The maximum height of Mid Rise Apartment buildings should be determined using the Large Infill Site Guidelines.
2. To minimize visual impact on and maximize integration with the existing neighbourhood, Mid Rise Apartments should:
 - a. Incorporate fundamental design elements, proportions, and character found within the neighbourhood; and,
 - b. Be constructed with durable, quality materials similar or complimentary to those found within the neighbourhood.
3. The building mass should be arranged to minimize shadowing and optimize access to sunlight on adjacent properties as set out in the Large Infill Site Guidelines.
4. A sun/shadow analysis should be prepared, including analyses of shade impacts for the spring and fall Equinoxes and the winter Solstice.
5. The privacy of adjacent dwellings should be maintained by minimizing overlook through:
 - a. Setbacks and articulation of the building, and,
 - b. Careful placement of windows, doors, patios and balconies.
6. Building facades should be modulated in plan and elevation and articulated to reduce the appearance of building bulk and to create visual interest. The building façade should be punctuated:
 - a. At a maximum of eight metres along the building frontage with an indentation no less than two metres wide and two metres deep; and,
 - b. At the primary street entrance to the building with an indentation of no less than two metres wide and two metres deep.
7. The maximum building length of Mid Rise Apartments should be no more than 48 metres, permitting views through the site and limiting building mass along the block face.
8. All units should have access to common, outdoor, ground level amenity space.
9. All ground-oriented units should be provided with private outdoor open space.
10. The building should front onto a street.
11. All ground level units with street frontage should have an individual, private entrance that fronts onto a street; all other units should be accessed through a front entrance hall fronting onto a street.
12. Retail/commercial uses should be developed on the ground floor of buildings which:
 - a. Front onto a commercial/shopping street; or,
 - b. Provide for retail uses in the context of a comprehensively planned development.

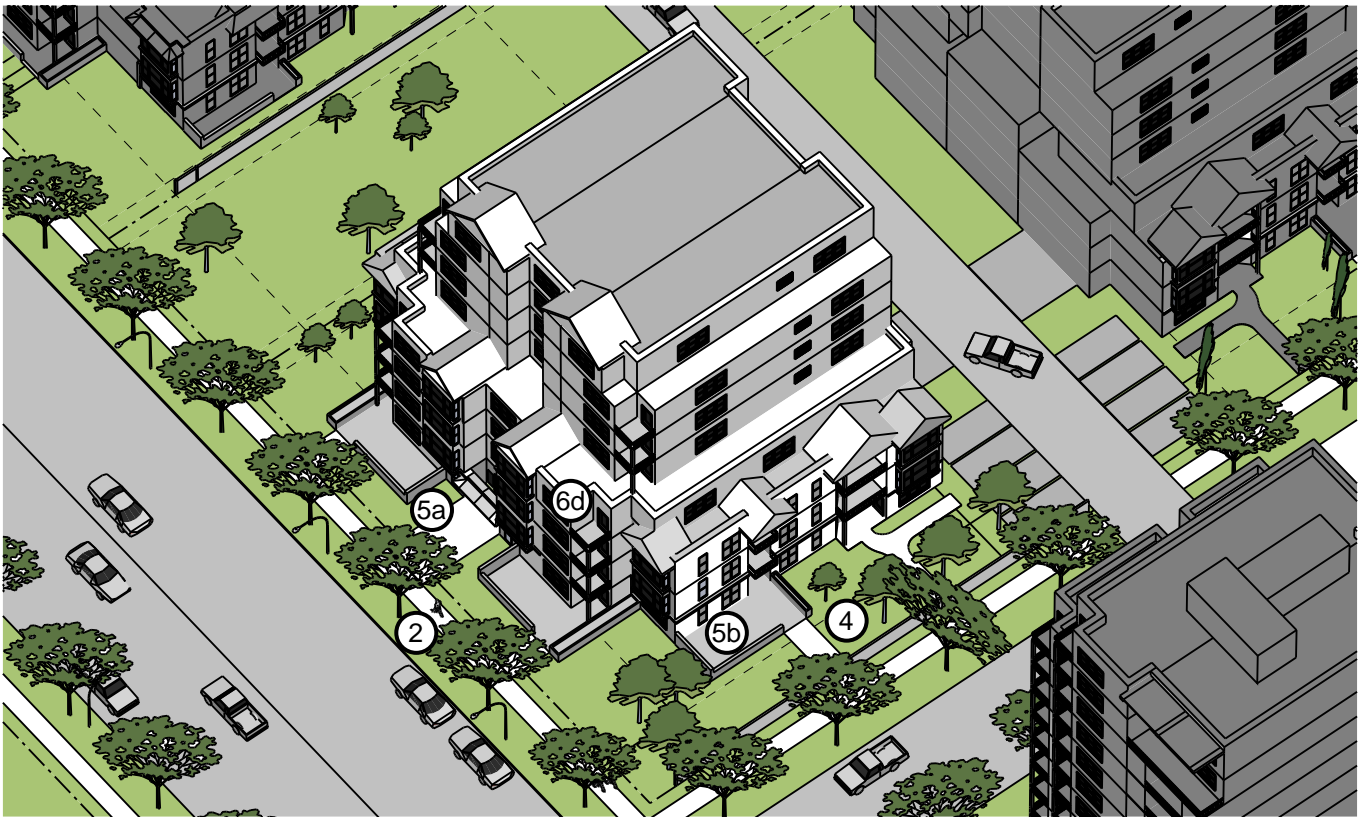

Site Design + Streetscape

1. The site should be landscaped in accordance with an approved Landscape Plan which provides for a high standard of landscaping on the site.
2. The Landscape Plan should:
 - a. Include an assessment of mature trees on site;
 - b. Provide for the retention of mature trees to the greatest extent possible; and,
 - c. Incorporate the design and planting of public sidewalk and boulevard areas adjacent to the site.
 - d. Illustrate the landscaping of yards and common outdoor amenity areas.
3. Upgrading of the adjacent public sidewalks and boulevard areas may be a requirement of development approval if warranted by the existing conditions.
4. The site design should, in concert with the design of the building:
 - a. Assist in optimizing access to sunlight on adjacent properties and on common outdoor amenity areas; and,
 - b. Maintain the privacy of adjacent homes through the use of fencing, screening and landscaping.
5. Common outdoor amenity space should be provided on site for residents which:
 - a. Accommodates the recreational and social needs of residents, including families with children where family units are proposed; and,
 - b. Is located where there is surveillance, sunlight and weather protection.
6. The streetscape design, including building features and landscape treatment along street frontages should integrate the new development into the existing neighbourhood by:
 - a. Providing entry transitions (e.g. use of steps, fences, gates, hedges, low walls) and semi-private outdoor spaces that create a comfortable relationship between the public realm of the street and the private space of the dwelling units;
 - b. Providing individual, private front entries and landscaped yards for ground floor units;
 - c. Providing a prominent front entrance to the building;
 - d. Using articulated building frontages, creating recessed balconies and roofline features; and,
 - e. By maintaining the existing development pattern along the street, including set backs, treed boulevards and no vehicular access from the street.

Mid rise apartment sites: Location + Distribution

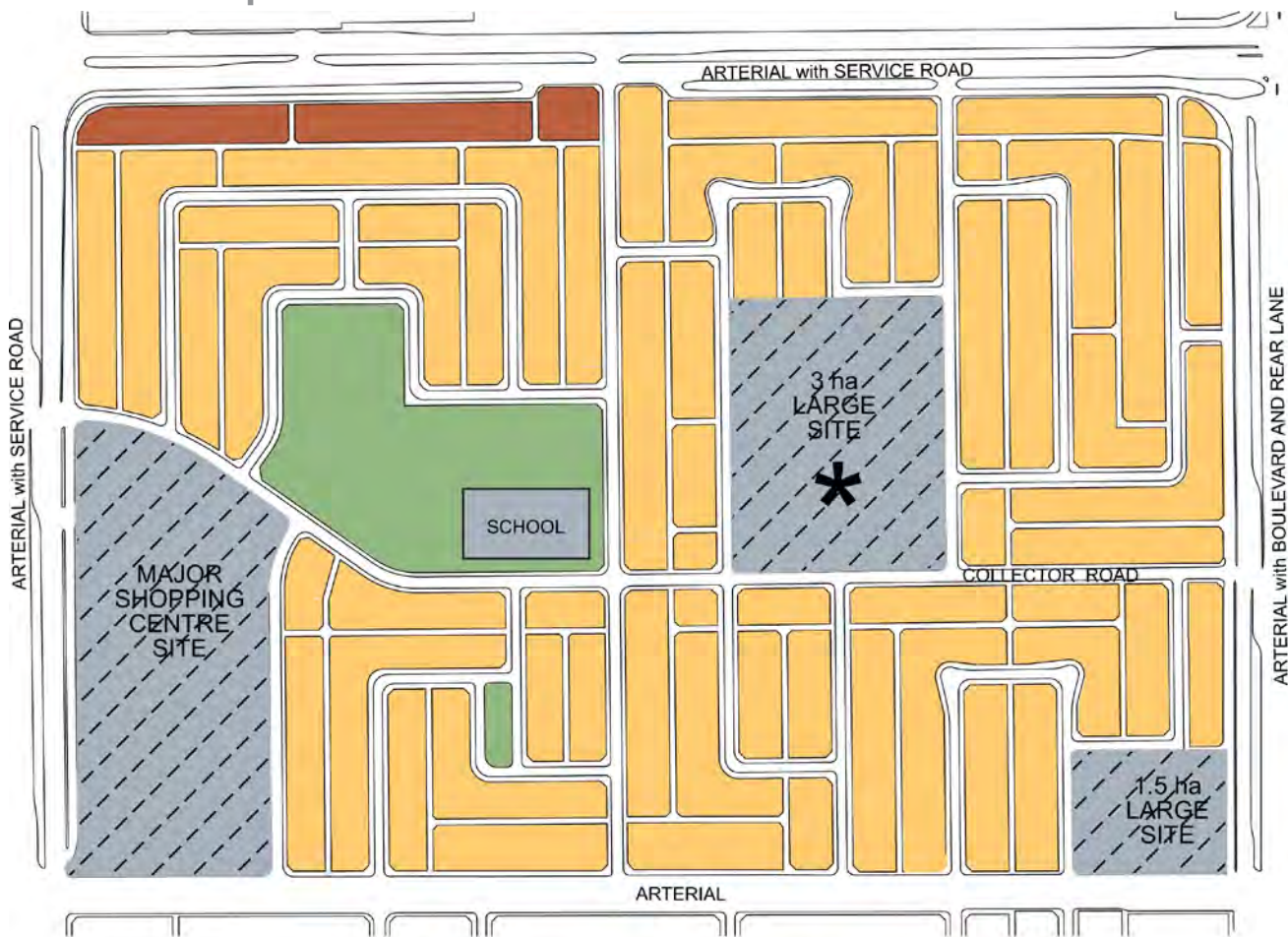

- Small Lot Development
- Mid Rise Apartments subject to large site guidelines
- Commercial
- * Mid Rise over 6 storeys subject to bonusing provisions

High Rise Apartments

Planning and Design Guidelines for Residential Infill in Mature Neighbourhoods

Using the Residential Infill Guidelines

These Guidelines for High Rise residential buildings are part of an overall set of Residential Infill Guidelines. In reviewing these Guidelines, the following sections of the complete Residential Infill Guidelines document should also be consulted:

1. Section B, Objectives for Residential Infill;
2. Section D, General Guidelines for Residential Infill in Edmonton's Mature Neighbourhoods; and,
3. Section H, Large Infill Site Guidelines; and,
4. Section J, Implementation of the Residential Infill Guidelines.

In addition, other regulations established by the City of Edmonton may apply, including:

1. The City of Edmonton Zoning Bylaw;
2. Any Area Redevelopment Plan that may be in place; and,
3. The Large Site Rezoning Process.

The Residential Infill Guidelines, together with the Large Site Infill Guidelines and other regulations, will determine whether or not a High Rise residential building will be permitted and will establish any specific requirements that may need to be addressed before it can be approved.

FOR MORE INFORMATION

Smart Choices Program,
 Planning and Policy Services Branch
 Planning and Development Department
 6th Floor, 10250 - 101 Street N.W.
 Edmonton, AB T5J 3P4
 PHONE (780) 496-6238 FAX (780) 401-7066
 www <http://www.edmonton.ca/smartchoices>

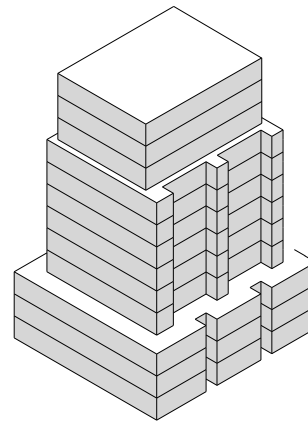

G2

High Rise residential buildings are tall buildings of nine storeys or higher. Given the need to deal with issues such as shadowing, urban design, traffic and parking, these buildings are generally constructed on large sites and in a context where these impacts can be mitigated. Thus, the location and distribution of High Rise residential buildings will be primarily governed by the Large Infill Site Guidelines.

The location of High Rise residential buildings may be further restricted by other City policy, including the policy to direct high density development to the vicinity of LRT Stations and Transit Terminals (see the Large Infill Site guidelines, Section H). The height and density of residential infill on large sites that do not meet the transit oriented location criteria will be restricted unless the development of those sites provides specific City and neighbourhood benefits such as affordable housing, open space, recreational facilities, or other similar amenities.



Location + Distribution

1. High Rise Residential Buildings should locate in the City's key activity centres, including:
 - a. The central area of the City, including Downtown, the Station Lands, and Downtown North Edge;
 - b. Areas adjacent to LRT Stations; and,
 - c. At existing regional or community level shopping centre sites.
2. High Rise Residential Infill buildings may also be located on other sites in mature neighbourhoods where they can meet the Large Site Infill Guidelines.
3. The preferred locations for High Rise Residential Buildings may be further defined through an Area Redevelopment Plan, Transit Oriented Development (TOD) Plan, or Site Vision and Context Plan.
4. High Rise apartments should have direct access to an arterial or collector road or a road with the demonstrated capacity to accommodate the development without undue impact on adjacent areas.

Parking

1. All parking should be accessed from the adjacent lane.
2. Resident parking should be provided on site in either underground or above ground parking structures.
3. Above ground parking structures should be fully screened with residential, commercial, or community uses to provide for active frontages.
4. Any surface visitor parking areas provided for High Rise buildings should:
 - a. Be developed at the side or rear of the building;
 - b. Be separated from residential units by landscaped buffers;
 - c. Be clustered into smaller parking lots and divided with landscaping (including trees); and,
 - d. Not impact the street or outdoor amenity areas.
5. The City should consider the relaxation of parking requirements for High Rise buildings at TOD locations.

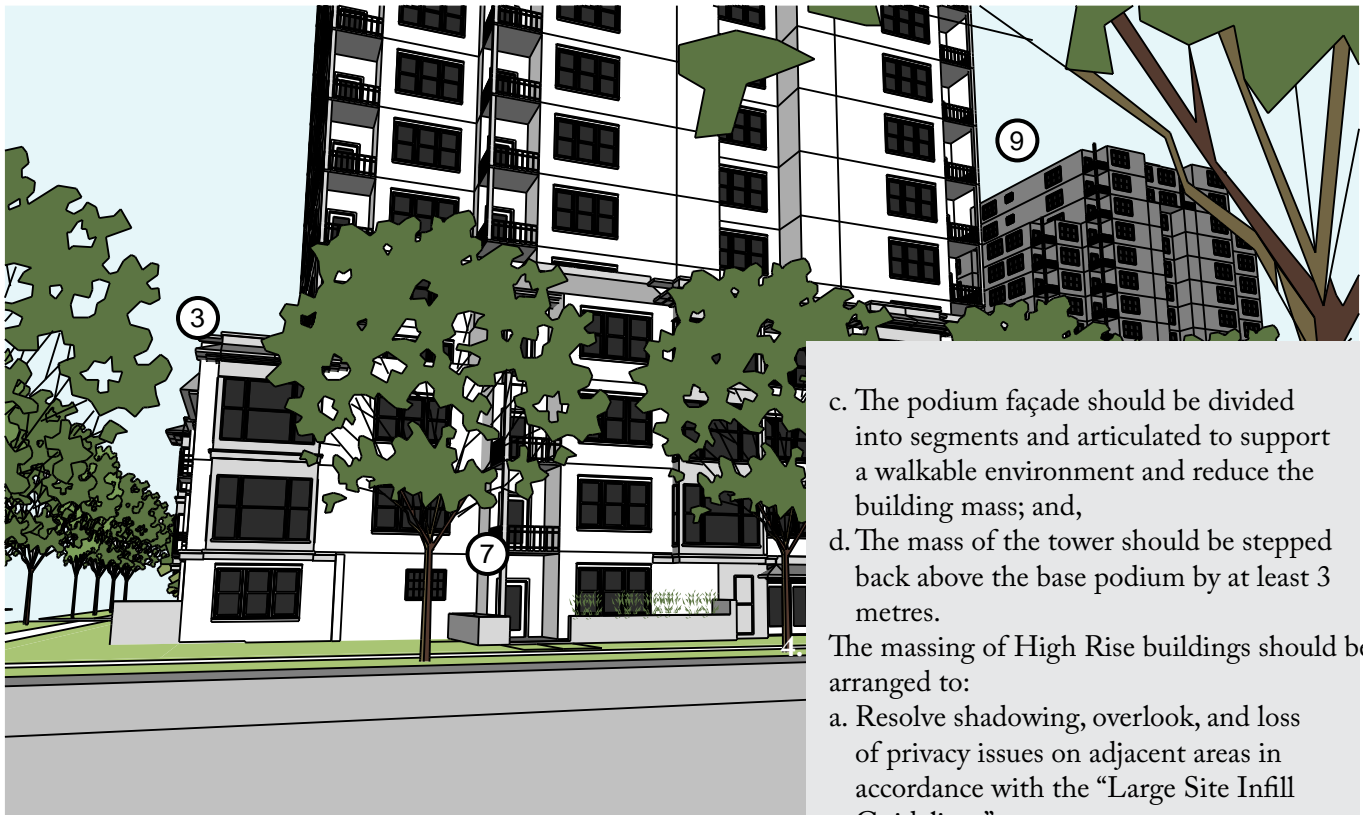

Built Form + Design

1. The maximum height of High Rise buildings on specific sites should be determined using the Large Site Infill Guidelines.
 2. High Rise residential towers should be designed:
 - a. As slender point towers with small floorplates to protect views and maximize access to sunlight for surrounding development;
 - b. With significant shaping to break down the scale of the tower;
 - c. With a distinctive expression of a base, middle, and top to better respond to the context of views to and from the tower; and
 - d. With floorplates generally no larger than 750 square metres gross.
 3. High Rise residential towers should be constructed on a podium base that creates a human scale street wall:
 - a. Typically, the podium should be a minimum height of 3 storeys, with a maximum height of 4 storeys; however, to accommodate specific site and design objectives, or specific housing forms in the podium, a blend of heights between 2 and 6 storeys could be considered.
 - b. Storeys above the 3rd floor should be stepped back and aesthetically be of a secondary character to the main base form;
 - c. The podium façade should be divided into segments and articulated to support a walkable environment and reduce the building mass; and,
 - d. The mass of the tower should be stepped back above the base podium by at least 3 metres.
- The massing of High Rise buildings should be arranged to:
- a. Resolve shadowing, overlook, and loss of privacy issues on adjacent areas in accordance with the “Large Site Infill Guidelines”;
 - b. Minimize shadowing of onsite or adjacent amenity space; and,
 - c. Provide for a transition between the building and adjacent residential areas in accordance with the “Large Site Infill Guidelines”.
5. A sun/shadow analysis should be prepared, including analyses of shade impacts for the spring and fall Equinoxes and the winter Solstice.
 6. The building should front a street.
 7. All ground level units with street frontage should have an individual entrance that fronts onto the street and private outdoor amenity space; all other units should be accessed through an entrance hall fronting onto a street.
 8. Retail/commercial uses should be developed on the ground floor of buildings which:
 - a. Front onto a commercial/shopping street; or,
 - b. Provide for retail uses in the context of a comprehensively planned development.
 9. High Rise residential towers should be separated from each other by:
 - a. A minimum of 30 metres if they are offset on the site such that one tower does not directly face the other; or,
 - b. A minimum of 35 metres if they face directly on to each other.
 10. The width of a High Rise residential tower should not exceed 36 metres.

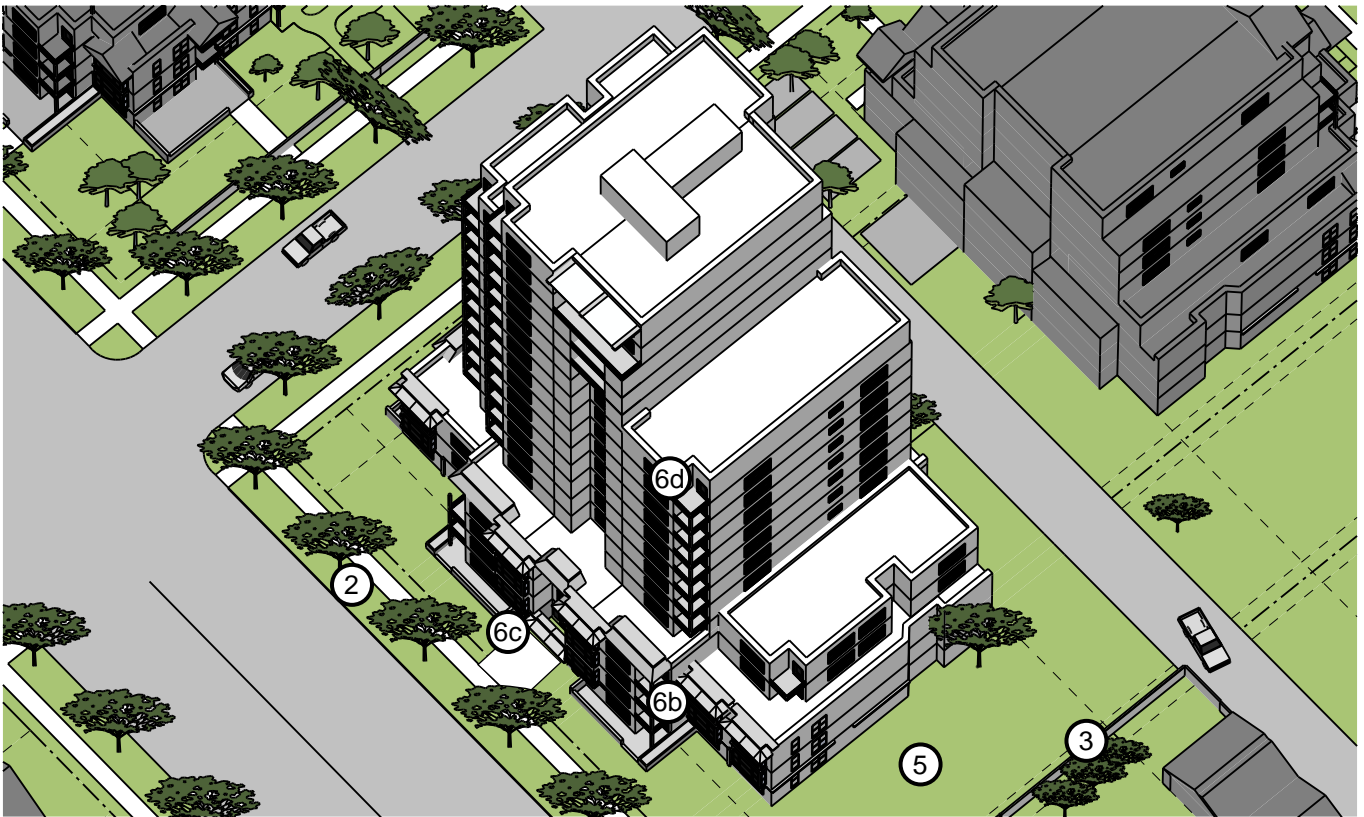

Site Design + Streetscape

0. The site should be landscaped in accordance with an approved Landscape Plan which provides for a high standard of landscaping on the site.
2. The Landscape Plan should:
 - a. Include an assessment of mature trees on site;
 - b. Provide for the retention of mature trees to the greatest extent possible; and,
 - c. Incorporate the design and planting of public sidewalk and boulevard areas adjacent to the site.
 - d. Illustrate the landscaping of yards and common outdoor amenity areas.
3. Upgrading of the adjacent public sidewalks and boulevard areas may be a requirement of development approval if warranted by the existing conditions.
4. The site design should, in concert with the design of the building:
 - a. Contribute to optimizing sunlight on adjacent properties and on common outdoor amenity areas; and,
 - b. Maintain the privacy of adjacent homes through the use of fencing, screening, and landscaping.
5. Common, outdoor amenity space should be provided on site:
 - a. To accommodate the recreational and social needs of residents, including families with children when family units are proposed; and,
 - b. At a location where there is surveillance, sunlight, and weather protection.
6. The streetscape design, including building features and landscape treatment along street frontages, should integrate the new development into the existing neighbourhood by:
 - a. Providing entry transitions (e.g. use of steps, fences, gates, hedges, low walls) and semi-private outdoor spaces that create a comfortable relationship between the public realm of the street and the private space of the dwelling units;
 - b. Providing individual, private front entries and landscaped yards for ground floor units;
 - c. Providing a prominent front entrance to the building;
 - d. Using articulated building facades and quality building materials, and creating recessed balconies and roofline features along street fronts; and,
 - e. By maintaining the existing development pattern along the street, including set backs, treed boulevards and no vehicular access from the street.

High rise apartment sites: Location + Distribution



Large Site Infill Guidelines

Planning and Design Guidelines for Residential Infill in Mature Neighbourhoods

Large sites represent an opportunity to achieve significant amounts of residential infill in mature neighbourhoods. If properly planned and managed, residential infill can occur on large sites with minimal impact on adjacent neighbourhoods and can bring positive benefits to both the City and the community.

To achieve City and neighbourhood objectives for residential infill and to create sustainable and livable neighbourhoods, the issues that create ongoing neighbourhood concerns and resistance to large site infill need to be dealt with sensitively.

The Large Site Infill Guidelines are planning and design guidelines that create a baseline against which DC2 rezoning applications on large sites in mature neighbourhoods can be prepared and evaluated. As City-wide guidelines they are necessarily general, and the sites used to illustrate the Guidelines are generic. Thus, it must be stressed that the Guidelines will need to be applied flexibly to specific sites. The Guidelines are not a substitute for site specific studies and creative planning and design solutions. At the same time, inherent in the Guidelines are the fundamental planning principles of transition between different scales of built form, the mitigation of negative impacts on adjacent properties and neighbourhoods, and the planning and design of livable, sustainable, communities.

The Guidelines are intended to improve the livability and community benefit of large infill projects, mitigate their potentially negative impacts and ensure that the benefits of the development are enjoyed by both new and existing residents.

The Guidelines, which follow include:

1. **The Definition of Large Sites** – which sites will be subject to the Guidelines;
2. **Large Infill Site Planning and Design Guidelines** – guidelines specific to planning large infill sites;
3. **A Site Planning and Design Template** – a template that illustrates the application of the guidelines in the neighbourhood context; and,
4. **Implementation Policies** – policies specific to the application of the Large Site Infill Guidelines during the planning and rezoning process.

H

Redeveloping Large Infill Sites – the Neighbourhood Context

Significant increases in density and the introduction of Large Scale buildings into existing neighbourhoods generates a number of issues which vary from site to site. In turn, the planning and design solutions are dependent upon the specific site and the neighbourhood context in which it is located. Thus, the challenge is to derive general planning and design guidelines that give guidance to resolving the issues and provide the flexibility to deal with the site context.

The primary issues that must be addressed in planning and designing a large site in the context of existing, mature neighbourhoods include:

1. **Integration with existing neighbourhoods** – integrating the new development into the fabric and street patterns of adjacent neighbourhoods.
2. **Planning a livable new neighbourhood** – planning for a high quality, well designed and livable neighbourhood that contributes to Edmonton as a community and is economically sustainable.
3. **Building a complete transportation and pedestrian system** – minimizing the impact of traffic and parking on adjacent neighbourhoods and creating a pedestrian oriented neighbourhood that contributes to environmentally sustainable transportation opportunities.
4. **Creating parks and amenity space** – ensuring that the recreation and open space needs of new and existing residents are met.
5. **Building community** – building a socially sustainable community.
6. **Landscape and street design** – creating comfortable pedestrian environments and attractive interface areas with adjoining neighbourhoods.
7. **Phasing of development** – sequencing the construction of large infill projects to reduce the impact on adjacent neighbourhoods.
8. **Transition between new and existing neighbourhoods** – creating the right interface between Large Infill Sites and existing small scale residential areas.

Defining Large Sites

The definition of large sites is derived from the application of the planning and design guidelines. A Site Planning and Design Template is provided which illustrates how the guidelines related to transition between existing neighbourhoods and infill sites can be achieved, and how building envelopes can be established. As can be determined through use of the template, applying the planning and design guidelines in the neighbourhood context creates opportunities for infill that are dependent upon site size and surrounding land uses.

Generally, application of the Large Site Infill Guidelines, as illustrated through the Site Planning and Design Template, results in the following:

- Mid Rise infill development generally becomes feasible on sites of 1 hectare or larger; and,
- High Rise infill development generally becomes feasible on sites of approximately:
 - 3 hectares on the periphery of a neighbourhood; and,
 - 5 hectares within an existing neighbourhood.

Thus, the Large Site Infill Guidelines apply to the evaluation of development proposals on all sites within or on the edge of Mature Neighbourhoods that are 1 hectare or larger.

The Large Site Infill Guidelines may also be used to evaluate development proposals on smaller sites in Mature Neighbourhoods where any of the following circumstances apply:

- Large Scale built forms, such as Mid Rise and High Rise buildings are proposed;
- Phasing of the project is proposed; or,
- Adjacent residential neighbourhoods may be impacted by such issues as:
 - shadowing;
 - traffic and parking; and,
 - loss of views.

Large Site Infill Planning and Design Guidelines

The following Guidelines apply to all large sites in mature neighbourhoods in Edmonton. The Guidelines are arranged to reflect the eight primary issues identified above.

Integration With Existing Neighbourhoods

1. Surrounding street patterns (roads and lanes) should be extended in and through any large site to break down the scale of the redevelopment site to planning units which reflect the typical City block of 1.5 hectares and to enhance connectivity between adjacent neighbourhoods.
2. The street network should divide large sites into smaller, connected blocks and form the basis of vehicular and pedestrian movement, including connections to open space, transit facilities and neighbourhood facilities.
3. Buildings should be sited and designed to have their major entries and as many individual dwelling unit entries as possible fronting onto the adjacent and internal streets, major pathways and major open spaces.

Planning a Livable, New Neighbourhood

1. Buildings should be organized to optimize sunlight to other buildings on the site and in the adjacent neighbourhood, and to public open spaces including streets.
2. Block arrangement and site design should respond to natural features, public open space and neighbourhood traffic patterns.
3. Buildings should be organized to ensure adequate spacing to maximize livability, ensure privacy and provide views through the site.
4. High Rise towers should be spaced to ensure privacy of residents and to provide outlook through the site.
5. High Rise towers should have a minimum separation distance of 30 metres if the tower faces are offset; towers which face directly onto each other should have a minimum separation distance of 35 metres.
6. Building siting and massing should be designed to prevent the creation of adverse wind conditions on streets and public open space.
7. Significant views should be identified and protected.

The Transportation System – Pedestrians, Vehicles and Parking

1. The pedestrian network should be an integral aspect of site design, and provide for:
 - a. Internal connections for residents to neighbourhood facilities, amenities and transit facilities;
 - b. External connections to facilities and amenities outside the infill site, including safe routes to school for children;
 - c. Public rights of way to enhance pedestrian circulation through the site, with particular attention to connecting parks and other public amenity sites;
 - d. Connections to the adjacent residential area, including access to public facilities on the site and routes through the site; and,
 - e. The security of common areas within individual development parcels.

The Transportation System – Pedestrians, Vehicles and Parking (CONT'D)

2. Where more than one large infill site is being developed in an area, or a second site is likely to develop in the near future, traffic studies should consider the cumulative impact of all potential sites on a neighbourhood.
3. Parking should be planned and provided as an integral part of Large Infill Site development and in accordance with the parking requirements of the Residential Infill Guidelines, including:
 - a. All required resident parking for Mid Rise and High Rise buildings should be provided underground or in above ground parking structures;
 - b. Parking structures at or above grade should be fully screened with residential, commercial or community uses to provide active frontages;
 - c. Surface parking provided for small scale residential development should be accessed from a rear lane, and be in the form of a parking pad or a detached or attached garage; and,
 - d. Access to all parking should be from a lane.
4. Parking structures, loading zones, and garbage collection and storage areas should not be located on streets or lanes which front onto existing residential areas.
5. Surface parking areas should:
 - a. Be developed at the side or rear of a building;
 - b. Not impact the street or outdoor amenity areas;
 - c. Be clustered into smaller parking lots and divided with landscaping;
 - d. Be separated from residential units by landscaped buffers; and,
 - e. Not front onto existing residential areas.
6. The provision for readily accessible public transit service should be integral to the design of the infill development:
 - a. The design of the transit service, including bus stops and routes through the neighbourhood should be completed early in the design process in consultation with Edmonton Transit;
 - b. Transit stops should be integrated with the pedestrian network and be within reasonable walking distance for all areas of the development and for people of all ages, including children and seniors; and,
 - c. Transit shelters should be provided at all bus stops, and shelters and passenger waiting areas should be integrated into the planning of boulevards and sidewalks.
7. Cycling routes through the area should be identified as part of the site planning process:
 - a. Cycling routes should be provided for in the design of the roads or in pathways or greenways through the site; and,
 - b. Connections to the multi-use trail system should be provided for.
8. Bicycle parking and storage facilities should be provided throughout the development

Creating Parks and Amenity Space

1. The location and shaping of public open space should be fundamental in organizing the block structure and locating development on large sites.
2. Onsite parks, open space and community amenities should be provided which:
 - a. Are sufficient to meet the needs of new residents;
 - b. Are appropriate for families with children;
 - c. Are integrated with and will complement existing community parks and amenities in the adjacent neighbourhood;
 - d. Are available for use by the adjacent community; and,
 - e. Are designed for a range of functions and seasons.
3. The specific amount of open space to be provided should be determined based on the size and population of the proposed development.
4. Parks and community amenities should be designed and constructed to a high standard and should be:
 - a. Integrated into the overall site design;
 - b. Located so that the space can be monitored by the residents; and,
 - c. Protected from negative impacts such as shadowing, traffic and noise.

Building Community

1. An assessment of local retail needs in a neighbourhood should be part of the planning of large sites.
2. Neighbourhood scale commercial uses, oriented to grade, that meet the daily and weekly needs of residents should either be provided onsite or met in the immediate vicinity of the site.
3. Site design should reflect the need to accommodate families with children, including:
 - a. Safe pedestrian routes to schools;
 - b. Common parks/activity areas and open space suitable for and readily accessible by children;
 - c. Outdoor play areas that reflect the needs of different age groups of children;
 - d. Accommodating supervision and oversight of play areas by parents/caregivers.
4. Semi-private and private outdoor spaces and indoor and outdoor amenities should be provided to meet the recreational and social needs of residents, including families with children.
5. Residential infill projects on large sites should include a variety of housing types to provide housing choices for households of different sizes, types (family, non-family), ages and incomes.
6. Non-market housing should be provided in accordance with the existing City wide policy for the provision of affordable housing.
7. To assist in long term community building, a minimum of 25 per cent of residential units should be designed to be suitable for families with young children, including the following features:
 - a. Ground-oriented (a direct access to the street);
 - b. Clearly defined private open space;
 - c. Access to adequate storage, including bulk storage and bicycle storage; and,
 - d. Adequate dwelling area for 2 or more bedrooms which are separate from living and kitchen/bathroom areas.

Landscape and Streetscape Design

1. A landscape plan prepared by a registered landscape architect, and providing for a high standard of landscaping, should accompany any development proposal for a Large Infill Site.
2. The Landscape Plan should include, as a minimum:
 - a. A design rationale;
 - b. A public open space plan;
 - c. A streetscape design, including tree planting, boulevard landscaping, street furniture, sidewalk treatment, location and treatment of transit stops;
 - d. Highlights of retained or altered natural landscape conditions;
 - e. Specific treatment of surfaces and plantings;
 - f. The type and quantity of landscape materials, including the use of drought tolerant plants and native species;
 - g. The treatment of streets fronting onto adjacent, existing residential areas; and,
 - h. Documentation of how water consumption has been minimized through features such as, but not limited to, the use of high efficiency irrigation systems and xeriscaping.
3. Street enhancements (such as double rows of street trees, boulevards, sidewalks, street furniture) should be designed to a high quality with a focus on the pedestrian and should be provided on new streets and on existing streets impacted by the development.
4. The site design and site layout should reflect existing site conditions and incorporate:
 - a. Existing trees on the site; and,
 - b. Natural water courses or any other significant natural feature, including the retention of these features where possible.
 - c. Daylighting of natural streams, where possible.

Phasing of Development

1. In order to reduce the impact of infill construction and to ensure a timely transition between existing and new development, phased development projects should:
 - a. Develop the edge of the site where it fronts existing residential use in the first phase of the project in order to prevent empty or underutilized lots facing the surrounding neighbourhoods; and,
 - b. Renovate or refurbish existing buildings that are retained in the first phase.

Transition Between Existing Neighbourhoods and Large Infill Sites

The following is a summary of the Guidelines related to establishing a transition between existing neighbourhoods and Large Infill Site developments. The Guidelines are illustrated in the following section, The Site Planning and Design Template. The Transition Guidelines for large sites do not cover all the possible circumstances and site contexts for a large site. (i.e. when the large site is adjacent to a ravine or large district park) There will be instances when the site context needs to be considered so that the intent of the guidelines can be reasonably applied.

1. Separation of the Site from Existing Development:
 - a. A road or lane should separate existing residential areas and the infill site.
 - b. In some circumstances, a developed public pathway protected by a Statutory Right of Way may be appropriate.
2. Minimizing Shadowing:
 - a. Adjacent properties should not be subject to undue over-shadowing between the spring and fall Equinoxes. This can be achieved by limiting the height of buildings on the infill site to below a 35 degree angle measured from the property line of adjacent residences (35 degrees is the angle of the sun at the Equinox in Edmonton).
 - b. Where direct sunlight is not a factor, such as for neighbourhoods on the south side of an infill project, adequate set back of tall buildings can be achieved by limiting the height of buildings on the infill site to below a 45 degree angle measured from the property line of adjacent low scale residences.
 - c. The requirements for limiting shadowing of adjacent properties should be refined though detailed shadowing studies specific to the site. These studies should include sun/shadow analyses for the spring and fall Equinoxes and the winter Solstice.
3. Building Form on the Edges of Infill Sites
 - a. The interface between an infill site and its neighbourhood should be designed as a transition with an active, two sided streetscape; there should be no large, uninhabited setbacks on the edge of the site.
 - b. Edges of infill sites facing low scale residentially zoned lands across a local residential street (including collector and local roads) should be developed at a maximum of 2 ½ storeys; or, if facing across an arterial, edges should be developed as a 2 to 4 storey street wall.
 - c. Edges of infill sites facing lands across the street that are zoned for Low Rise Apartment buildings or larger scale residential or commercial development may be developed as Mid Rise residential buildings, subject to height and setback requirements.

Transition Between Existing Neighbourhoods and Large Infill Sites (CONT'D)

4. Setback of Mid Rise and High Rise Buildings on the Infill Site:
 - a. When the edges of infill sites face areas zoned for low scale residential across a local street or arterial, buildings in the interior of the infill site should be located 12 metres back from the rear wall of the lower scale edge buildings in accordance with the Site Planning and Design Template that follows, and within the height and building envelope that falls within the angular planes described above; or,
 - b. When the edges of the infill site face existing areas zoned for apartment or commercial development, Mid Rise buildings up to 8 storeys may be developed as edge buildings. These edge buildings should:
 - i. Be set back on a 3 to 4 storey podium;
 - ii. Have floors above the podium set back a minimum of 2 metres in accordance with the Site Planning and Design Template;
 - iii. Have heights and building envelopes that fall within the angular planes described above; and;
 - iv. Be separated/set back from interior buildings by 25 metres.
5. Large Infill Sites and Large Scale Building Forms:
 - a. Mid Rise residential buildings, when the Guidelines are applied, are generally feasible on sites of 1 hectare or larger. If the context of a specific site less than 1 hectare merits consideration for Mid Rise development under a DC2 rezoning, it may be considered if it meets the applicable Large Site Infill Guidelines.
 - b. High Rise buildings are generally feasible on the periphery of neighbourhoods on sites of 3 hectares or more. If the context of a specific site less than 3 hectares merits consideration of a DC2 rezoning, it may be considered if it can meet the applicable Large Site Infill Guidelines.
 - c. High Rise buildings are generally feasible on large sites within neighbourhoods that are 5 hectares or more.
 - d. Single High Rise buildings should not be developed on isolated lots in the interior of mature neighbourhoods; they should only be built as part of a comprehensive development that includes other forms of residential infill.

The Site Planning and Design Template

– Establishing Building Height and Form, and the Transition Between New Infill and Existing Neighbourhoods

The Site Planning and Design Template illustrates the Transition Guidelines set out above. The Template provides direction on planning and designing for the transition between the existing neighbourhood and the infill site by determining building envelopes (heights, setbacks) and permitted building forms according to the context of the site.

The Template is based on the following principles:

1. Providing access to sunlight and minimizing shadowing on adjacent residential areas;
2. Setting Mid and High Rise buildings back from existing, low scale residential areas; and,
3. Buffering adjacent low scale residential areas by providing small and medium scale building forms on the edge of the infill site.

The Template assists in determining:

1. The **form and height** of buildings permitted on the **edges** of the infill site (“**edge buildings**”);
2. The **height** of buildings permitted in the **interior** of the site;
3. The **setbacks** required for large scale, Mid and High Rise buildings.

The Template is illustrated below in two ways:

1. First, the specific transition guidelines which determine the height of edge buildings and interior buildings, depending upon the neighbourhood context, are illustrated.
2. Second, the application of the guidelines collectively to large sites, which generally determines the minimum feasible site sizes for different forms of Large Scale development, are illustrated for three different sites of 1.5, 3, and 5 hectares.

It should be noted that in the context of this Template, the term ‘local street’ refers to both collector and local roads.

Applying the Specific Transition Guidelines

1. Large site surrounded by low scale residential and local streets

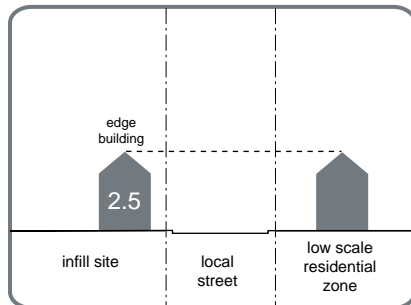
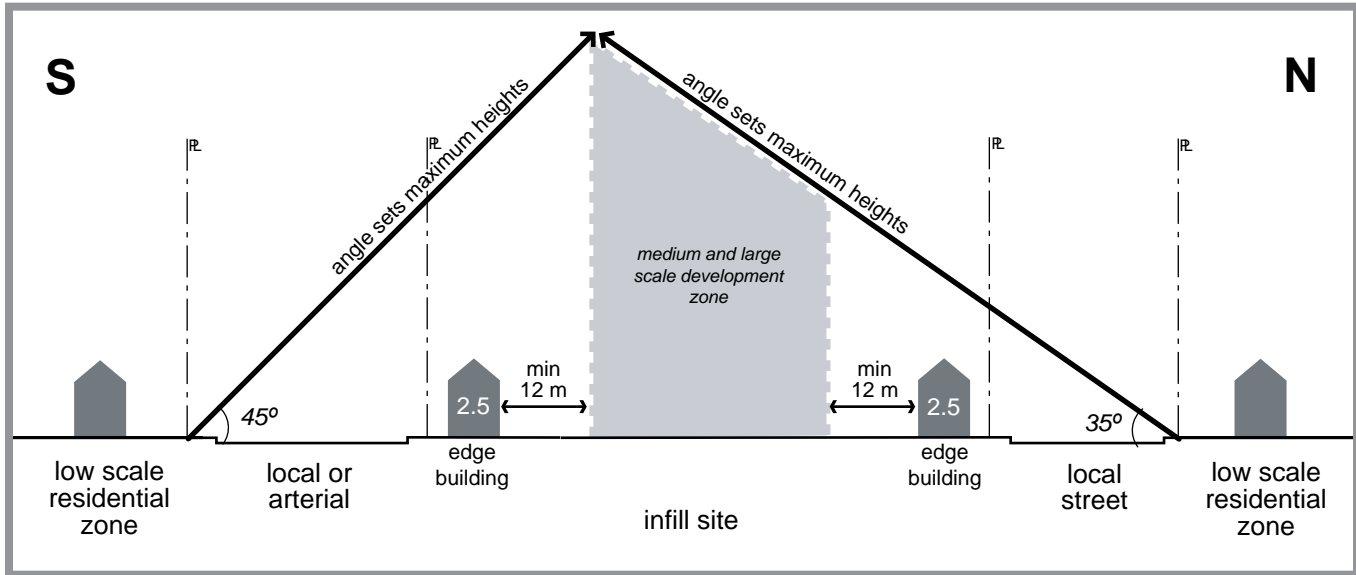

1. When **the edge** of the infill site **faces low scale residentially zoned lands across a local, residential street, lane, or equivalent right of way**:
 - a. residential buildings **on the edge** of the infill site **fronting the street or lane** should be a **maximum of 2 ½ storeys**;

1. Large site surrounded by low scale residential and local streets

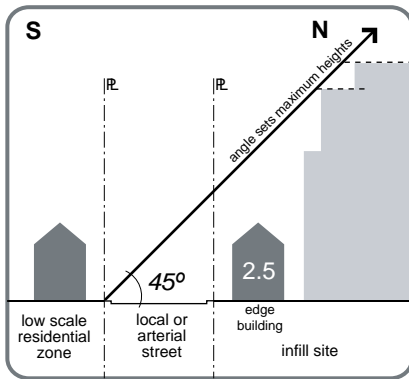

- b. the **maximum height** of **interior buildings** should be **limited** by the building **envelope** created by:
 - i. a **45 degree angle** taken from the property line of the residences across the street or lane from the **southern edge** of the infill site; and,

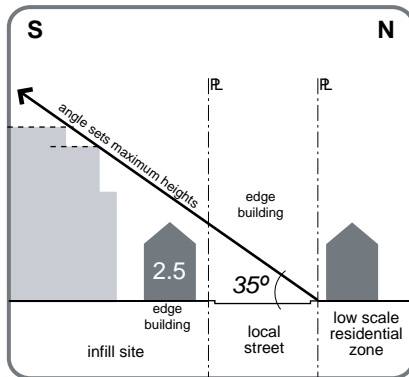

- ii. a **35 degree angle** taken from the property line of the residences across the street or lane from the **remaining three edges** of the site;

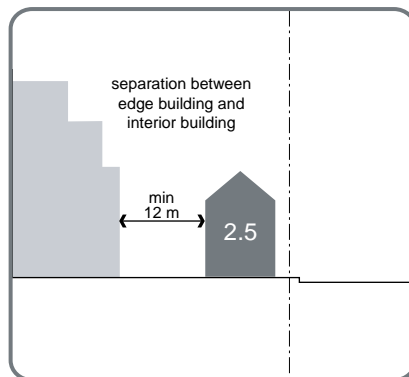

- c. **interior buildings** constructed behind the low scale edge within the building envelope established above should be set back from the rear of the edge buildings a minimum of 12 metres.

2. Large site surrounded by low scale residential adjacent to arterial

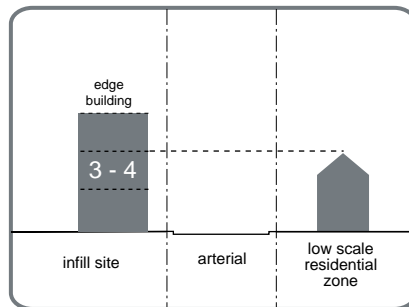
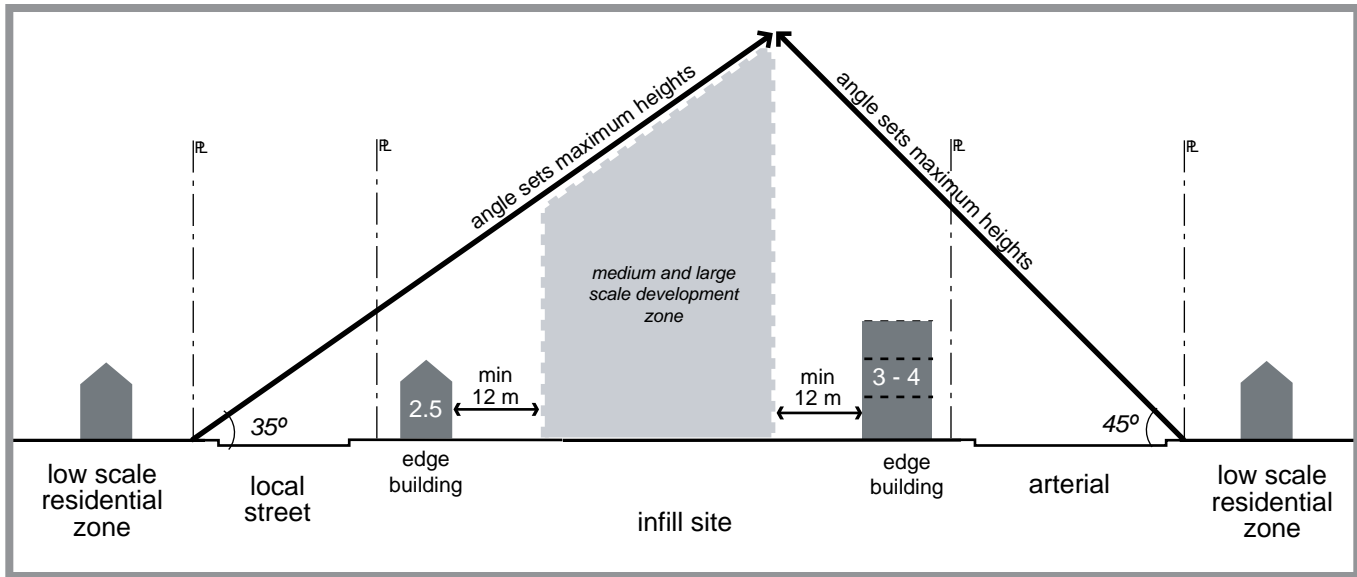

2. When **the edge** of the infill site **faces low scale residentially zoned lands across an arterial road**:
 - a. a street wall of **2 to 4 storey** Low Rise buildings should be developed **on the edge** of the infill site that fronts the **arterial**;

2. Large site surrounded by low scale residential adjacent to arterial

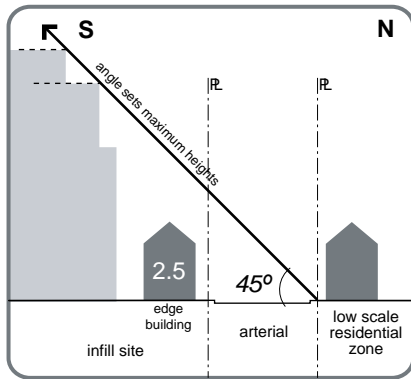

- b. the **maximum height** of **interior buildings** should be **limited by** the building **envelope** created by:
 - i. a **45 degree angle** taken from the property line of the residences **across the arterial**;

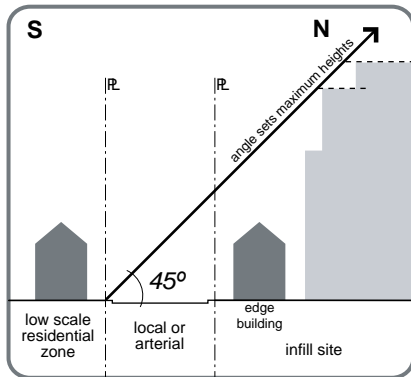

- ii. a **45 degree angle** taken from the property line of the residences across from the **southern edge** of the infill site; and,

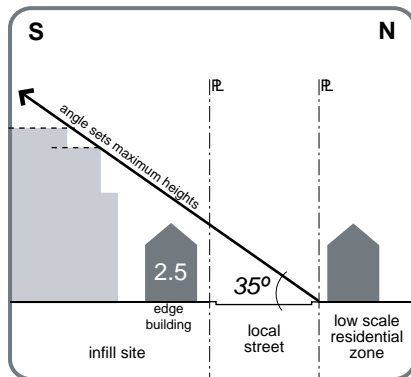

- iii. by a **35 degree angle** from the **remaining edges** of the infill site;

2. Large site surrounded by low scale residential adjacent to arterial

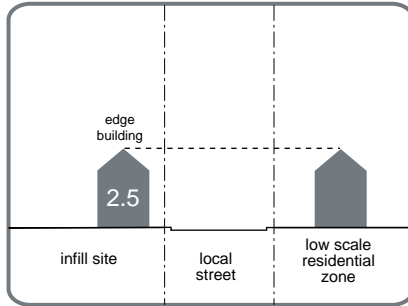

c. a **maximum of 2 ½ storey** residential buildings should front the street or lane on the **remaining edges** of the site that do not front on an arterial;

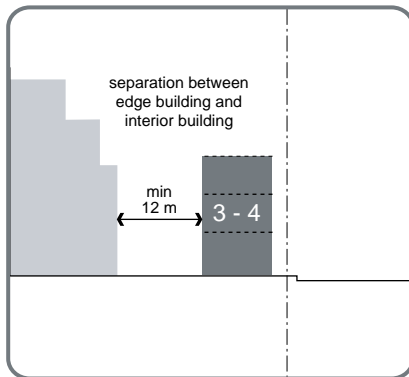

d. **interior buildings** constructed behind the street wall should be set back from the rear of the edge buildings a minimum of 12 metres.

3. Large site adjacent to commercial

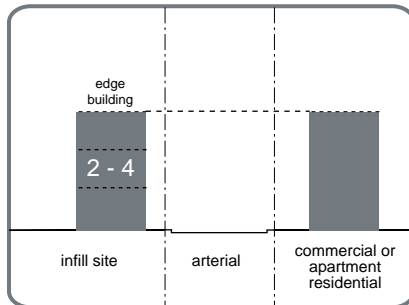
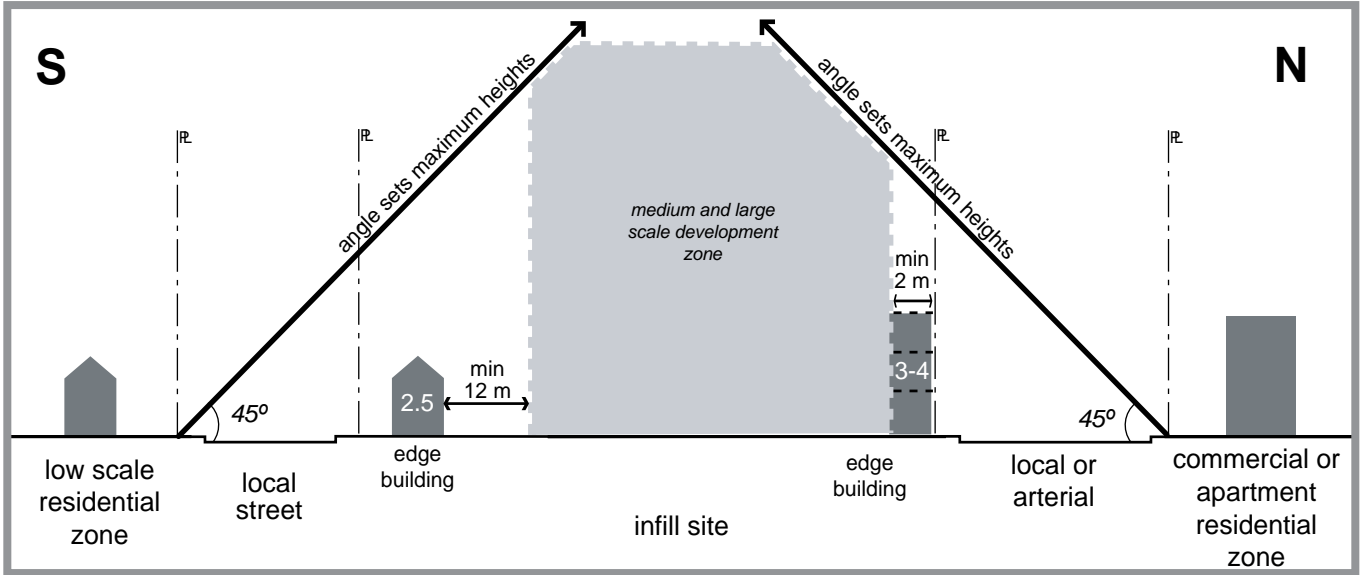

3. When **the edge** of the infill site **faces commercial, Low Rise apartment or higher density zoned lands** across a local street, arterial, or lane,
- a. a street wall of 2 to 4 storey residential buildings should be developed; **or**,

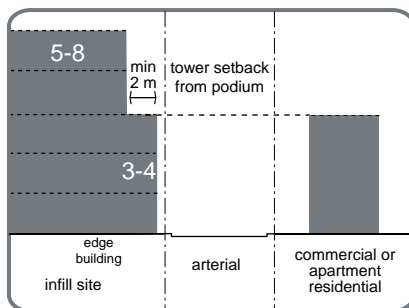

- b. **5 to 8 storey Mid Rise** residential buildings may be developed **on that edge: 3 to 4 storey podium** should be constructed, and floors above the podium should be set back a minimum of 2 metres;

3. Large site adjacent to commercial

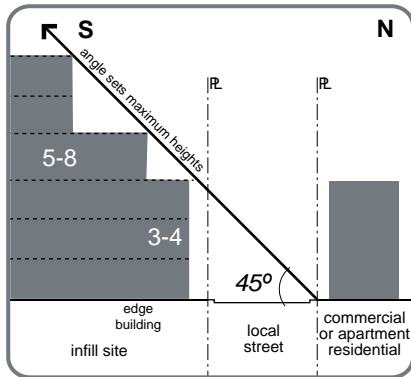

c. the **maximum height** of **Mid Rise edge buildings** should be **limited by** the building **envelope** created by a **45 degree angle** taken from the property line of the **commercial, low rise, or higher density residential** properties;

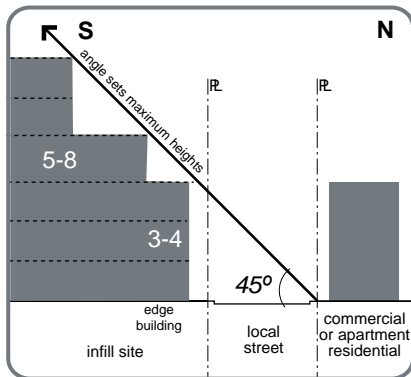

d. the **maximum height** of the **interior buildings** should be **limited by** the building **envelope** created by:

- i. a **45 degree angle** taken from the property line of the **commercial, low rise, or higher density residential properties**;

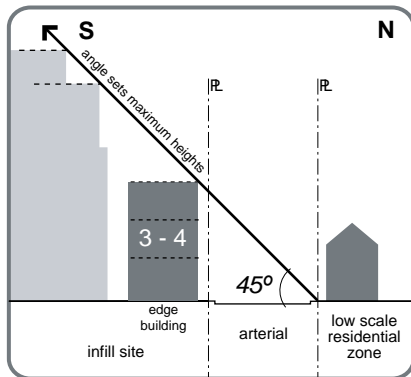

- ii. a **45 degree angle** taken from the property line of the residences **across an arterial**;

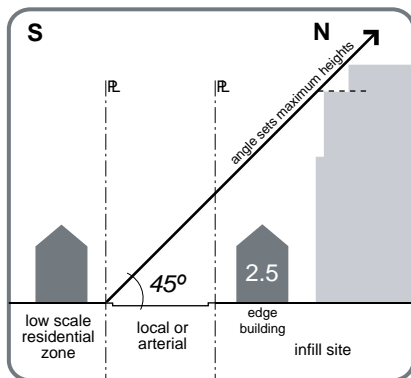

- iii. a **45 degree angle** taken from the property line of the residences across from the **southern edge** of the infill site; and,

3. Large site adjacent to commercial

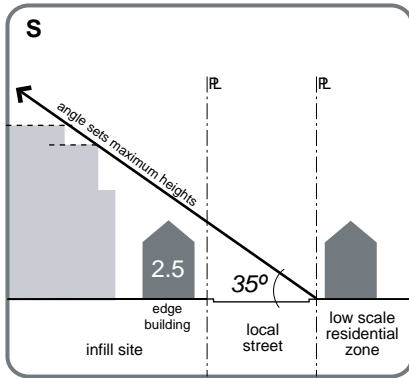

iv. by a **35 degree** angle from the **remaining edges** of the infill site;

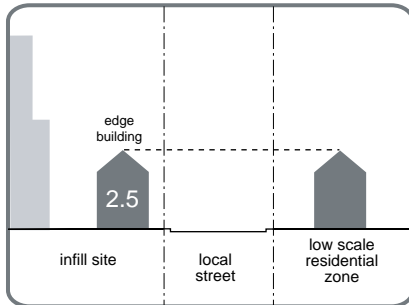

e. a **maximum of 2 ½ storey** residential buildings should front the street or lane on the **remaining edges** of the site that do not front on an arterial or on the commercial or higher density areas;

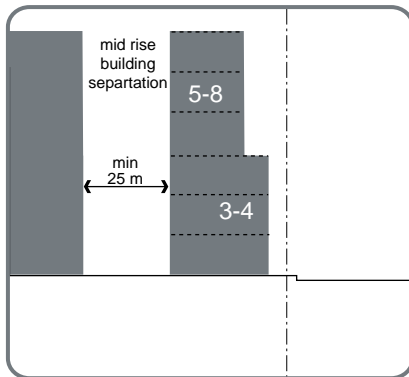

f. **interior buildings** constructed behind the Mid Rise edge buildings should be set back from the rear of the edge buildings by a minimum of 25 metres.

Applying the Site Planning and Design Template

1. One city block (approximately 1.5 hectares) surrounded by low scale residential will permit only Mid Rise infill.

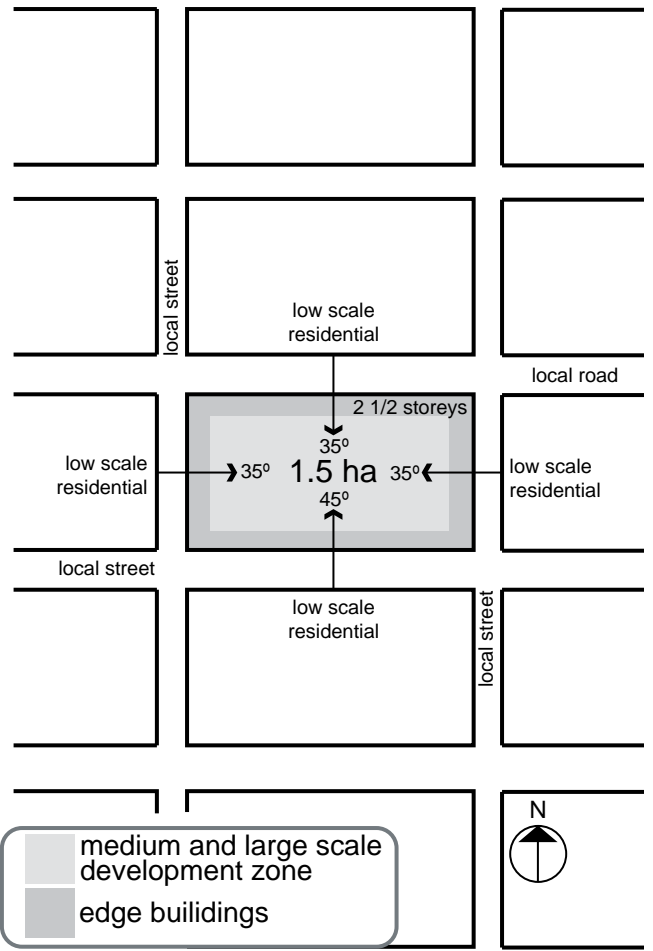

2.5 storey edge buildings

low rise interior buildings

lane extended through site
— limits medium and large scale development

35° plane

mid rise building

45° plane on South edge

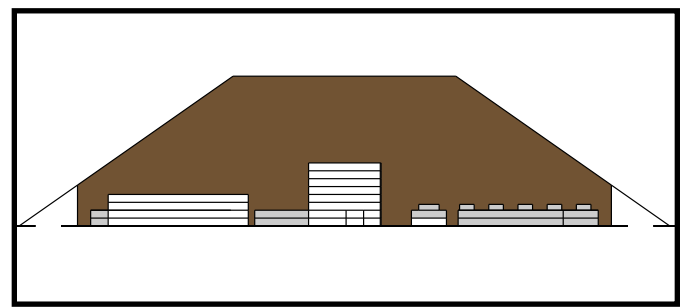
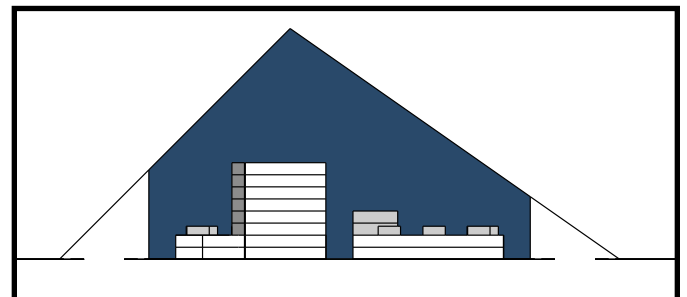
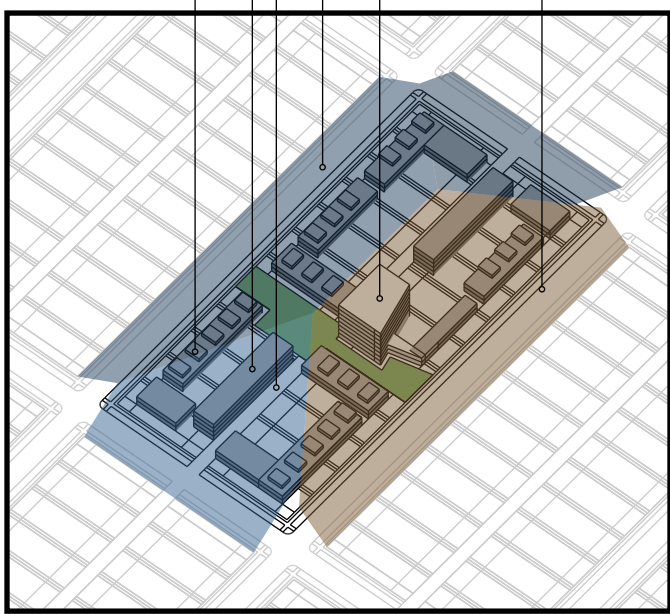

2. Generally, a 3.0 hectare site, or two city blocks must be on the edge of a neighbourhood in order to develop towers above eight storeys.

- 2.5 storey edge buildings
- maximum 750m² floorplates
- low rise interior buildings
- street and lanes extended through site – limits medium and large scale development location
- all large scale development requires 35m spacing, maximum building width is 36m
- mid rise edge building
- 45° plane on commercial edge
- 45° plane on South edge

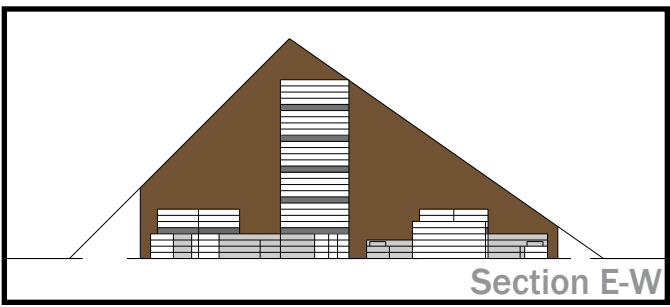
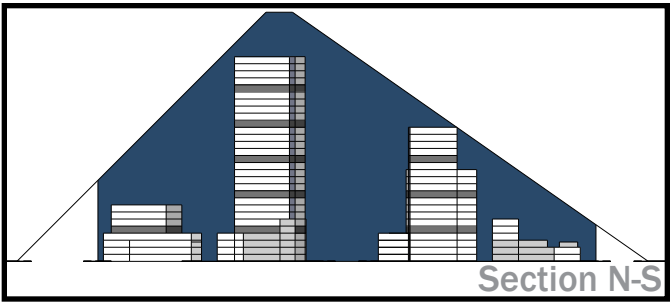
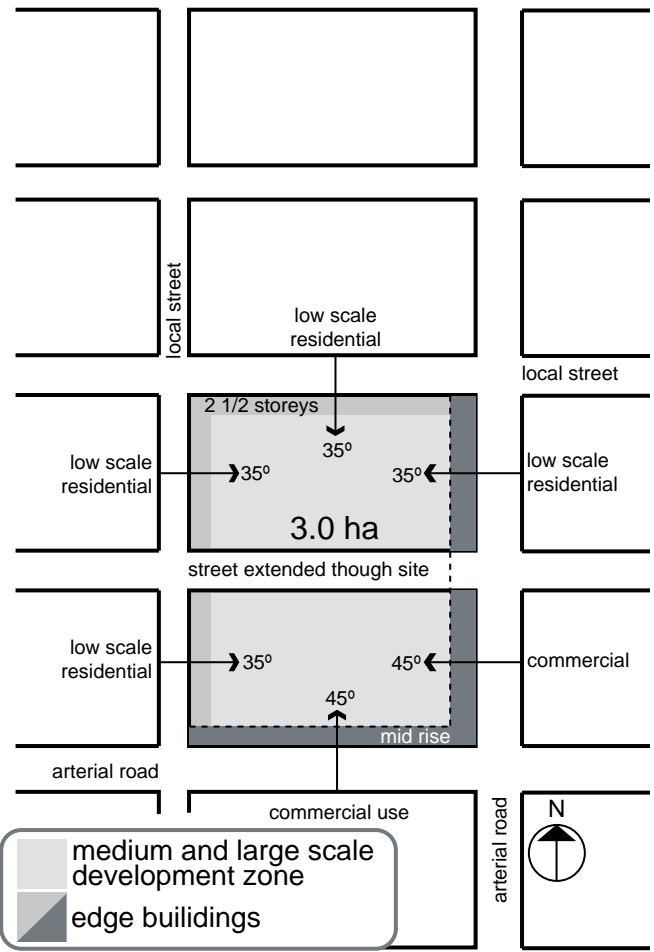
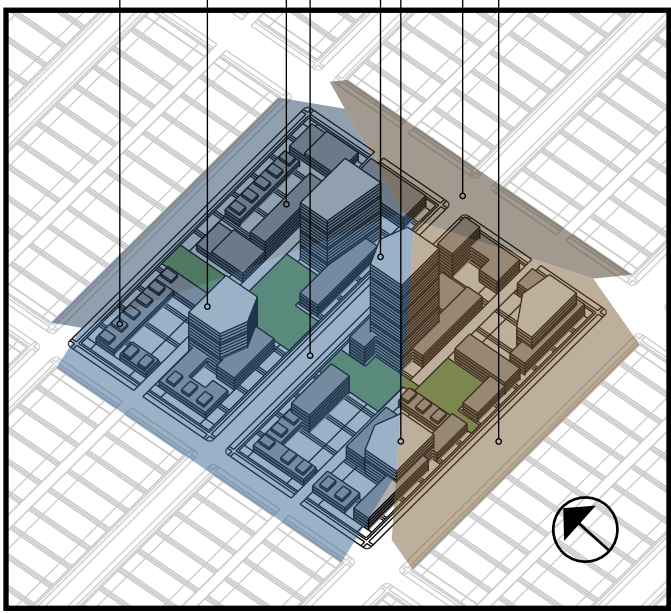

3. A 5.0 hectare site, or approximately three city blocks, is required for high rise development in the centre of a mature residential neighbourhood.

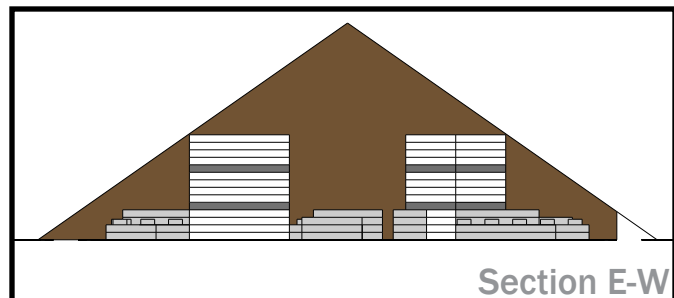
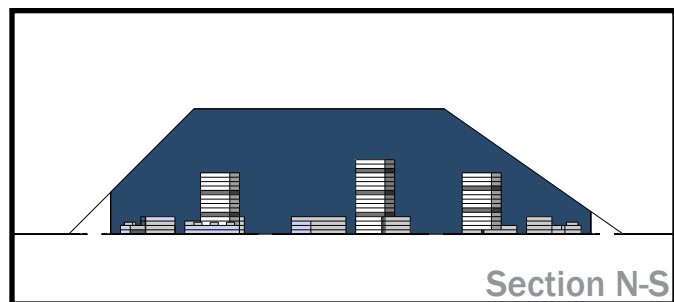
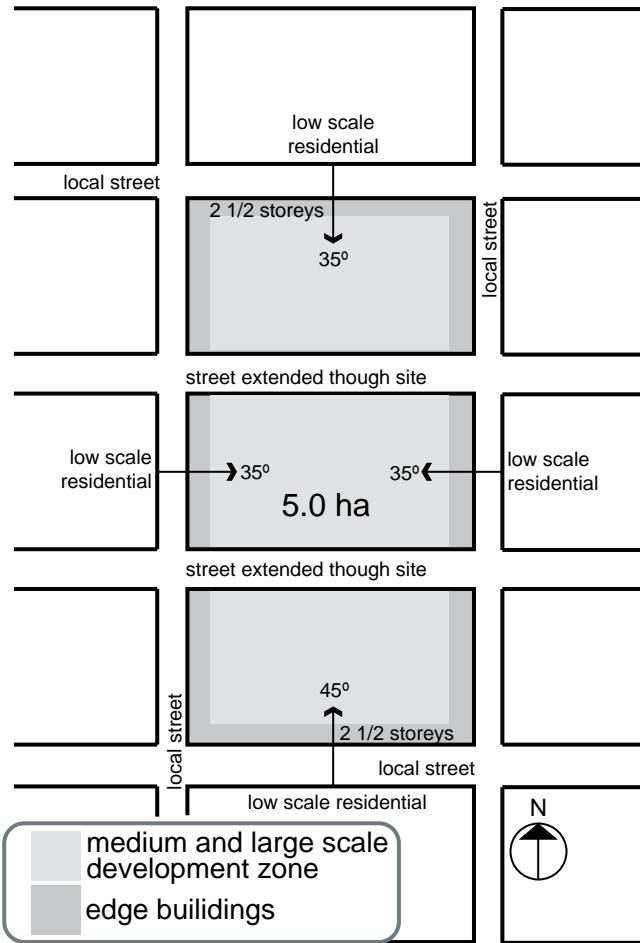
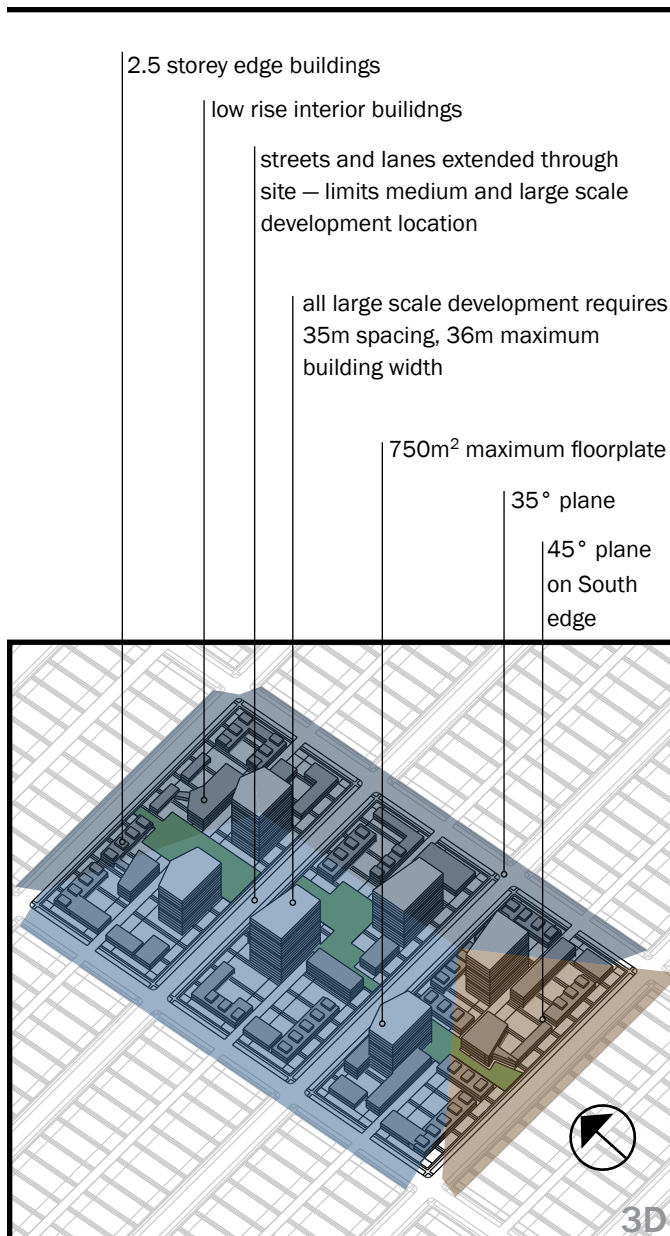

Implementation of the Large Site Infill Guidelines

1. The planning and design of all large sites should be governed by the Large Site Infill Guidelines.
2. The Large Site Infill Guidelines provide a planning and design framework for the integration of new infill development into mature neighbourhoods. At the same time, each site will have its own challenges and anomalies and specific solutions to design issues will need to be developed while ensuring that the spirit and intent of the guidelines are achieved and specific requirements are met. As noted below, where a specific site merits consideration for infill but significantly challenges the intent of the Guidelines, the City may require the preparation of a Site Vision and Context Plan in advance of considering a rezoning application.
3. Regulation of the redevelopment of Large Infill Sites in mature neighbourhoods will require the use of the City's direct control zoning (DC2).
4. The City's Large Site Rezoning Process should apply to all DC2 rezoning applications on Large Infill Sites. In some instances, the Large Site Rezoning Process may require that a Site Vision and Context Plan be prepared in advance of considering a rezoning application. The Site Vision and Context Plan provides, among other things, for an opportunity for the City's Planning and Development Department to refine the application of the Guidelines to specific sites in consultation with the applicant and the community.
5. The built form and design of residential infill and streetscape design on Large Infill Sites should also be governed by the applicable "Residential Infill Guidelines", including:
 - a. Section D, General Guidelines for Residential Infill
 - b. Section E, Small Scale Infill Guidelines;
 - c. Section F, Medium Scale Infill Guidelines;
 - d. Section G, Large Scale Infill Guidelines;
 - e. Section I, Implementation of the Residential Infill Guidelines.
6. The height and density of development permitted on Large Infill Sites will be further governed by the City's policy to direct high density development to the vicinity of LRT stations and Transit Terminals that have been identified in the Municipal Development Plan and Transportation Master Plan. Consideration of rezoning applications for Large Scale, high density development on Large Infill Sites in mature neighbourhoods will be subject to the following:
 - a. On Large Infill Sites that are not associated with an LRT Station or Transit Terminal as identified in the Municipal Development Plan, rezoning should be considered to a maximum height of 6 floors and a maximum density of 125 units per hectare (the current RA7 zone), provided the Large Site Infill Guidelines are achieved; and,

- b. Consideration should be given to bonusing for increased density on non-transit oriented development sites up to 225 units per hectare (the current RA8 zone) and to increasing the height provided that:
 - i. one or more significant benefits are gained by the City and the neighbourhood through the rezoning, including:
 - affordable housing;
 - additional open space;
 - recreational facilities; or,
 - other community amenities; and,
 - ii. the design of the development, including the height of the buildings, is in accordance with the Large Site Infill Guidelines.
7. A design rationale should be provided outlining the project goals and design guidelines in the context of the Large Site Infill Guidelines.
8. The Large Site Infill Guidelines apply to large sites located in mature neighbourhoods that are being proposed for rezoning. It is intended that the principles of transition, the requirements for edge buildings and setbacks of Large Scale buildings will be dealt with during the rezoning process. Thus, it should be clarified that in some neighbourhoods where the zoning is in place for Large Scale buildings, and existing plans are being implemented, that these guidelines may not be applicable. Similarly, the Guidelines related to location and distribution of Mid Rise and High Rise buildings may not be applicable, although the Guidelines relevant to Built Form and Design, Site Design and Streetscape, and Parking should generally apply.

Glossary of Terms

Planning and Design Guidelines for Residential Infill in Mature Neighbourhoods

Affordable Housing – refers to housing that requires no on-going operating subsidies and that is targeted for occupancy by households who are income challenged (earn less than the median income for their household size and pay more than 30% of that income for housing) and require no in-situ support services.

Community and Regional Level Shopping Centres - refers to any shopping centres having a site area of 2.0 or more hectares.

Current DC2 Rezoning Process – refers to the existing direct control rezoning process used in the City of Edmonton, as provided for in the current Edmonton Zoning Bylaw.

Family-oriented Housing - refers to housing that is suitable for families with young children. This form of housing includes the following features: ground-orientation (direct access to the street); clearly defined private open space; access to adequate storage, including bulk storage and bicycle storage; and adequate dwelling area for 2 or more bedrooms which are separate from living and kitchen/bathroom areas.

Large Residential Infill Site – means those sites in mature neighbourhoods that are generally over one hectare in size and are proposed for residential infill development and, therefore, must be considered under the Large Site Rezoning Process. The definition of Large Residential Infill Sites and the Planning and Design Guidelines governing their development are set out in the Residential Infill Guidelines.

Large Scale Buildings – refers to Mid Rise residential buildings of 5 to 8 storeys, and High Rise residential buildings which are 9 storeys or taller.

Large Site Infill Guidelines – refers to residential infill guidelines which apply only to Large Residential Infill Sites; these sites are generally defined as being 1.0 hectares in area or larger. In some circumstances these guidelines may be applied to smaller sites if they are complex sites which involve Large Scale Buildings.

Large Site Rezoning Process – means the “Planning and Consultation Process for Rezoning Large Residential Infill Sites in Mature Neighbourhoods”; also referred to as the “New Planning Model for the Redevelopment of Large Sites in Mature Neighbourhoods”. This process applies only to Large Residential Infill Sites.

LEED (Leadership in Energy and Environmental Design) – refers to a rating system that promotes and certifies the design, construction and operation of green/sustainable buildings and communities (LEED-ND).

Mature Neighbourhood Overlay - refers to a section of the Edmonton Zoning Bylaw that regulates residential development in Edmonton’s mature neighbourhoods to ensure that it follows the traditional character and design of the surrounding area.

Medium Scale Infill - refers to Row Housing of 6 or more units, Stacked Row Houses, and Low Rise Apartment buildings of 3-4 storeys.

Non-Market Housing – refers to housing that receives direct capital and/or operating subsidies from any order of government to enable short or long-term occupancy by a range of lower-income individuals and households.

Preliminary DC2 Rezoning Application – means the preliminary rezoning application which is to be submitted to the City prior to an applicant proceeding to develop a final rezoning application; the submission requirements for the Preliminary Application are set out in the Large Site Rezoning Process.

Residential Infill Guidelines – means the “Planning and Design Guidelines for Residential Infill in Edmonton’s Mature Neighbourhoods”. These Guidelines relate to all forms of residential infill on all sites in mature neighbourhoods and also include planning and design guidelines specific to Large Residential Infill Sites in mature neighbourhoods.

Site Vision and Context Plan – refers to a Plan to be prepared in certain circumstances prior to the City considering a DC2 rezoning application. The terms of reference for the Plan, and how it fits within the DC2 rezoning process, are defined in the City of Edmonton’s Large Site Rezoning Process.

Small Scale Infill - refers to Secondary Suites, Garage Suites, Garden Suites, Duplexes (Up/Down), Semi Detached Dwellings (Side/Side Duplexes), Fourplexes, and Row Housing of up to and including 5 units.

Socially Sustainable Neighbourhood - refers to an inclusive community in which a broad spectrum of individuals and families of varied means have access to appropriate housing, services and amenities. It is a neighbourhood in which residents enjoy an enhanced quality of life and are actively engaged in planning and community development activities.

Implementation

Planning and Design Guidelines for Residential Infill in Mature Neighbourhoods

Among the key City objectives in developing the Residential Infill Guidelines are those related to gaining community support for infill developments and reducing delays and conflicts in the review of planning applications.

The achievement of these objectives will require that the Guidelines be implemented as consistently as possible. In particular, the applicability of the Guidelines needs to be clear, and staff need to be able to consistently interpret and apply the Guidelines in concert with the community and the development industry.

At the same time, as City wide guidelines, they are necessarily general. **Thus, it must be stressed that flexibility must be exercised in adapting the Guidelines to specific sites.**

At the same time, if a rezoning proposal significantly challenges the ability of the City to accomplish the intent of the Guidelines, additional planning related to the site may be required to identify and address site planning and design issues before a rezoning application is considered.

Where the Guidelines Will Apply

The complete set of Residential Infill Guidelines will apply to the consideration of rezoning applications for residential infill in all mature neighbourhoods (see Map 1, Edmonton's Mature Neighbourhoods)

In addition, the Large Site Infill Guidelines in Section H of the Residential Infill Guidelines Manual, apply to large sites located in mature neighbourhoods that are being proposed for rezoning. It is intended that the guidelines related to transition between different zoning districts, the requirements for edge buildings, and setbacks of Large Scale buildings will be dealt with during the rezoning process. Thus, it should be clarified that in some neighbourhoods where the zoning is already in place for Large Scale buildings, and existing plans are being implemented, that these Guidelines may not be applicable.

Similarly, the Residential Infill Guidelines related to the location and distribution of Mid Rise and High Rise buildings may not apply to existing sites with high density zoning, although the Guidelines relevant to Built Form and Design, Site Design and Streetscape, and Parking should be generally applicable.

How the Guidelines Are Used in the Preparation and Review of Rezoning Applications

1. Developers use the Guidelines to prepare all rezoning applications for residential infill in Mature Neighbourhoods unless a specific, conventional zoning district has been amended by the City to include the Residential Infill Guidelines, and that zone accommodates the proposed development.
2. Developers use the Guidelines to prepare DC2 rezoning

J

applications for all development on Large Infill Sites. DC2 zoning is used to deal with the complexities of Large Infill Site redevelopment.

3. City planning staff use the Residential Infill Guidelines to evaluate all rezoning applications for residential infill in mature neighbourhoods, and in addition, use the Large Site Infill Guidelines to evaluate DC2 rezoning applications for all Mid and High rise development and all development on Large Infill Sites.
4. City planning staff use the Guidelines to guide the preparation of Site Vision and Context Plans which may be required under the Large Site Rezoning Process.
5. City planning staff use the Guidelines as a basis for community consultation with respect to the evaluation of the merits of a rezoning application for residential infill.
6. City planning staff, subject to other regulatory requirements being met, will support rezoning applications to allow residential infill development that meets the Location and Distribution Guidelines and all other applicable Infill Guidelines.
7. City planning staff use the Guidelines to initiate amendments to the Zoning Bylaw to accommodate residential infill through conventional zones.

Relationship of the Infill Guidelines to Neighbourhood Planning

City planning staff use the Residential Infill Guidelines on an ongoing basis:

1. To evaluate applications to amend existing Area Redevelopment Plans (ARP's), noting that the Guidelines do not replace the existing ARP's.
2. To guide the preparation of new neighbourhood or Area Redevelopment Plans, TOD Plans and Site Vision and Context Plans which may be required under the Large Site Rezoning Process.

Interpretation of the Guidelines

The Residential Infill Guidelines have been drafted to apply to all mature neighbourhoods. This does raise the question about how they can be interpreted to apply in different neighbourhoods and on sites which are not in the same context. This issue is particularly true of the Built Form and Design section of the Guidelines which outline, for example, that residential infill projects should:

1. Incorporate fundamental design elements, proportions, and character found within the neighbourhood; and,
2. Be constructed with durable, quality materials consistent with the surrounding neighbourhood.

As noted above, Planning and Development staff will need to exercise some flexibility in the interpretation of the Guidelines, and in particular, will assist in the interpretation of the Guidelines. One approach to this lies with the requirement noted below that a “**Design Rationale**” be provided with each application, which can be the basis for discussion about whether or not the Guidelines have been achieved.

The Design Rational should address how the design reflects other buildings in the neighbourhood with respect to such matters as:

1. Do the rooflines reflect those found in the adjacent homes fronting on the same street?
2. Does the massing and form of the building reflect that found in the immediate area?
3. Do the building materials (such as the roofing material and siding) reflect those used in the immediate area?
4. Do the windows reflect the design found in the area?
5. Do the entries reflect those found in the neighbourhood - are there porches or verandas? wood railings or metal railings?
6. Does the streetscape and landscape design reflect what is found in the neighbourhood?

Where the architecture of the proposed development is not typical for the neighbourhood, the Development Officer will evaluate the application based on a combination of how well it meets the Infill Guidelines and the merits of the individual application.

Ongoing Implementation Process for Applicants

The following implementation steps are provided as a general guide to the key steps that applicants should follow in considering an application for a residential infill development in a mature neighbourhood.

All Applicants

As part of any rezoning or development permit application, all applicants are required to include a statement with their submission which outlines how the proposed infill development meets the Residential Infill Guidelines, and includes a design rationale which addresses the requirements related to the Built Form and Design and the Site Design and Streetscape. Information is available from the City on the required content of the submission, noting that a comprehensive statement is required for applications for Large Scale buildings and Large Site Infill.

Applicants for Small Scale Residential Infill Projects

1. Determine whether the proposed development is within an existing ARP, and complies with the policies of the ARP.
2. Determine whether the proposed location and design of the development meets the criteria outlined in the Residential Infill Guidelines.
3. Ensure that the property is of adequate size and frontage to allow the development (refer to the Zoning Bylaw and Residential Infill Guidelines); it may be necessary to consider the consolidation or subdivision of the lands.
4. Apply for rezoning of the site if necessary; if a conventional zoning district has been amended to incorporate the Guidelines, a rezoning should not be necessary in most cases.
5. Apply for a development permit that meets all the requirements of the Zoning Bylaw, including the Mature Neighbourhoods Overlay.

Applicants for Medium Scale Residential Infill Projects

1. Determine whether the proposed development is within an existing ARP and complies with the policies of the ARP.
2. Determine whether the proposed location and design of the development meet the criteria outlined in the Residential Infill Guidelines.
3. Ensure that the property is of adequate size and frontage to allow the development (refer to Zoning Bylaw and Infill Guidelines).
4. Apply for rezoning of the site; a DC2 rezoning may be required, or a rezoning to RA7 or RF6 may be appropriate if the Medium Density Overlay applies.
5. Apply for a development permit that meets all the requirements of the Zoning Bylaw (including the Medium Density Overlay).

Applicants for Large Scale Residential Infill Projects

1. Determine whether the proposed development is within an existing ARP, and is complies with the policies of the ARP.
2. Determine whether the proposed location and design of the development meets the criteria outlined in the Residential Infill Guidelines.
3. Determine whether the proposed development meets the Guidelines for the development of Large Infill Sites.
4. Ensure that the property is of adequate size and frontage to allow the development (refer to Zoning Bylaw and the Residential Infill Guidelines and Large Site Infill Guidelines).
5. Consult with the City planning staff to determine whether or not the Large Site Rezoning Process will apply, noting that the City may decide that a Site Vision and Context Plan is required prior to consideration of a rezoning application.
6. Apply for Direct Control Zoning that fulfills the requirements of the Infill Guidelines.
7. Apply for a development permit that meets all the requirements of the DC2 zoning.

In all cases, applicants or community members who require assistance in interpreting the Residential Infill Guidelines or other related regulations and bylaws, or who require clarification of the related application and review processes, should contact the City Planning and Development Department for assistance.