

THE CITY OF EDMONTON

PROJECT AGREEMENT
VALLEY LINE LRT – STAGE 1

Schedule 5 – D&C Performance Requirements

Part 5: Facilities

VALLEY LINE PROJECT
SCHEDULE 5
D&C PERFORMANCE REQUIREMENTS
PART 5: FACILITIES
TABLE OF CONTENTS

SECTION 5-1 – GENERAL REQUIREMENTS	5-1
5-1.1 APPLICABLE CODES, STANDARDS AND REGULATIONS	5-1
5-1.2 REFERENCE SECTIONS	5-1
5-1.3 MATERIALS AND COMPONENTS	5-1
5-1.3.1 Pressure Equalized Rain Screen Insulated Structure Technique	5-1
5-1.3.2 Glazed Aluminum Curtain Walls and Glazing Systems.....	5-2
5-1.3.3 Roofs – General.....	5-2
5-1.3.4 Standing Seam Metal Roofing.....	5-2
5-1.3.5 Doors	5-3
5-1.3.6 Slip Resistance of Flooring.....	5-3
5-1.3.7 Bird Control Devices.....	5-3
SECTION 5-2 – STOPS AND STATIONS	5-4
5-2.1 INTRODUCTION	5-4
5-2.1.1 General	5-4
5-2.1.2 Performance Requirements.....	5-4
5-2.1.3 Key Information for Stops and Davies Station.....	5-4
5-2.2 APPLICABLE CODES, STANDARDS AND REGULATIONS	5-7
5-2.3 STOP AND STATION EGRESS	5-7
5-2.4 STOP DESIGN VARIABLES	5-7
5-2.5 SIGNAGE	5-8
5-2.5.1 General	5-8
5-2.5.2 Wayfinding	5-8
5-2.5.2.1 Stop/Station Identification Sign.....	5-8
5-2.5.2.2 Directional Wayfinding Sign.....	5-8
5-2.5.3 Regulatory.....	5-9
5-2.5.3.1 No Smoking Signs	5-9
5-2.5.3.2 Security Camera Signs	5-9
5-2.5.4 Information.....	5-10
5-2.5.4.1 Washroom Access Control Signs	5-10
5-2.5.4.2 Elevator Service Information Board	5-10

5-2.5.4.3	Room Identification Signs	5-10
5-2.5.4.4	Transit Watch Information Sign.....	5-10
5-2.5.5	Accessibility	5-10
5-2.5.5.1	Automatic Door Signs	5-10
5-2.5.6	Safety.....	5-10
5-2.5.6.1	Emergency Phone Sign	5-10
5-2.5.6.2	Security Camera Identification Sign.....	5-11
5-2.5.6.3	Escalator Safety Sign.....	5-11
5-2.5.6.4	In Case of Fire – Do Not Use Elevator sign.....	5-11
5-2.5.7	Schedule Boards	5-11
5-2.6	SURGE AND QUEUING SPACES	5-12
5-2.7	SLIP RESISTANCE OF FLOORING	5-12
5-2.8	PLATFORMS AND PLATFORM AMENITIES.....	5-12
5-2.8.1	Side-Loading Platforms	5-12
5-2.8.2	Centre-Loading Platforms.....	5-12
5-2.8.3	General Platform Requirements	5-12
5-2.8.3.1	General	5-12
5-2.8.3.2	Platform Length.....	5-13
5-2.8.3.3	Platform Height	5-13
5-2.8.3.4	Platform Cross-Fall	5-13
5-2.8.3.5	Platform Horizontal Clearance to LRV.....	5-13
5-2.8.3.6	Platform Edge Tactile Attention Indicator	5-13
5-2.8.3.7	Platform Configuration and Functional Zones	5-13
5-2.8.4	On-Platform Poles	5-16
5-2.8.5	Access to Existing Buildings	5-16
5-2.8.6	Canopies.....	5-16
5-2.8.7	Shelters.....	5-16
5-2.8.8	Seating.....	5-17
5-2.8.9	Leaning Rails	5-17
5-2.8.10	Waste and Recycling Receptacles	5-17
5-2.8.11	Passenger Interface Equipment	5-17
5-2.8.11.1	General	5-17
5-2.8.11.2	Ticket Vending Machines.....	5-18
5-2.8.11.3	Validators	5-18
5-2.8.11.4	Variable Message Signs	5-19
5-2.8.11.5	Information Panels	5-19
5-2.8.11.6	Global Wayfinding Maps	5-20
5-2.8.11.7	ETS TV screens.....	5-21

5-2.8.11.8 Corporate Advertising Screens	5-21
5-2.8.12 Clock Tower	5-22
5-2.8.13 Baseplates	5-23
5-2.8.14 Non-Trackside Platform Edges.....	5-23
5-2.9 ACCESSIBILITY	5-24
5-2.9.1 Accessibility to Platforms	5-24
5-2.9.2 Vertical Circulation.....	5-24
5-2.10STORM AND MELT WATER DRAINAGE	5-24
5-2.10.1 Canopies and Roofs	5-24
5-2.10.2 Platforms.....	5-24
5-2.11MATERIAL AND COMPONENT REQUIREMENTS	5-25
5-2.11.1 Structural Glass	5-25
5-2.11.2 Heavy Timber Construction	5-25
5-2.11.3 Steel Doors and Frames.....	5-26
5-2.11.4 Overhead Coiling Grilles.....	5-26
5-2.11.5 Leaning Rails	5-26
5-2.11.6 Floor and Wall Tile.....	5-28
5-2.11.7 Floor Grilles.....	5-28
5-2.11.8 Stairs and Ramps	5-28
5-2.11.9 Passenger Elevators.....	5-29
5-2.11.10 Escalators.....	5-30
5-2.12STOP/STATION-SPECIFIC DESIGN REQUIREMENTS	5-30
5-2.12.1 Introduction	5-30
5-2.12.2 102 Street Stop.....	5-30
5-2.12.3 Churchill Stop	5-31
5-2.12.4 Quarters Stop	5-31
5-2.12.5 Muttart Stop	5-32
5-2.12.6 Davies Station.....	5-32
5-2.12.6.1 Program Requirements.....	5-32
5-2.12.6.2 Passenger Circulation Requirements	5-35
5-2.12.6.3 General Station Requirements.....	5-36
5-2.13CHURCHILL CONNECTOR	5-36
5-2.13.1 Introduction	5-36
5-2.13.2 Functional Program	5-38
5-2.13.3 Pedestrian Circulation Requirements	5-38
5-2.13.4 General Demolition and Construction Requirements	5-39
5-2.13.5 At-Grade Demolition and Construction Requirements	5-40

5-2.13.6	Donor Plaza	5-41
5-2.13.7	Below-Grade Passenger Flow Improvements	5-42
5-2.13.8	Material Requirements	5-42
SECTION 5-3 GERRY WRIGHT OPERATIONS AND MAINTENANCE FACILITY		5-48
5-3.1	INTRODUCTION	5-48
5-3.2	FUNCTION	5-48
5-3.3	DESIGN AND CONSTRUCTION REQUIREMENTS.....	5-48
5-3.3.1	General Requirements.....	5-48
5-3.3.2	Sustainability and LEED®.....	5-49
5-3.3.3	Design and Construction Capacity	5-49
5-3.3.4	Expansion Design Capacity Requirements	5-49
5-3.4	OPERATIONS CONTROL CENTRE	5-50
5-3.5	CITY OFFICE	5-50
5-3.6	MAIN DATA CENTRE.....	5-51
5-3.7	SITE CONSTRAINTS.....	5-51

Table and Figures

TABLE 5-2.1.3 – KEY INFORMATION FOR STOPS AND STATIONS.....	5-5
TABLE 5-2.4 – STOP DESIGN VARIABLES	5-7
FIGURE 5-2.8.3: STOP PLATFORM FUNCTIONAL LAY-OUT.....	5-15
FIGURE 5-2.8.12: CLOCK TOWER.....	5-23
TABLE 5-2.12.6 – DAVIES STATION ROOM PROGRAM	5-33
TABLE 5-2.13.1 – CHURCHILL CONNECTOR ROOM PROGRAM	5-37
FIGURE 5-2.13A: CHURCHILL CONNECTOR FUNCTIONAL RELATIONSHIP – AT-GRADE	5-44
FIGURE 5-2.13B: CHURCHILL CONNECTOR FUNCTIONAL RELATIONSHIP – BELOW- GRADE	5-45
FIGURE 5-2.13C: SIR WINSTON CHURCHILL SQUARE – EXISTING CONDITION.....	5-46
FIGURE 5-2.13D: CHURCHILL CONNECTOR CONSTRUCTION – BELOW-GRADE	5-47
FIGURE 5-3.7: GERRY WRIGHT OMF SITE.....	5-52

PART 5: FACILITIES

SECTION 5-1 – GENERAL REQUIREMENTS

5-1.1 APPLICABLE CODES, STANDARDS AND REGULATIONS

- A. Without limiting Section 1-1.7 [*Reference Documents*] of this Schedule and except as otherwise specified herein, the Design and Construction of all Building Structures and all associated equipment, components, materials, systems, and sub-systems shall comply with:
1. ABC, unless otherwise specified in this Schedule; and
 2. CSA S478 "*Guideline on Durability in Buildings*".

5-1.2 REFERENCE SECTIONS

- A. The Design and Construction of Building Structures shall comply with the following:
1. architectural: according to this Part 5 - [*Facilities*] of this Schedule;
 2. structural: according to Part 4 - [*Transportation and Building Structures*] of this Schedule; and
 3. mechanical and electrical: according to Part 6 - [*Systems*] of this Schedule.

5-1.3 MATERIALS AND COMPONENTS

5-1.3.1 Pressure Equalized Rain Screen Insulated Structure Technique

- A. Design and construct non-glazed exterior walls of Davies Station, the Churchill Connector, and all administrative areas, LRV maintenance shop(s), the OCC, and the main Data Centre of the Gerry Wright OMF using the pressure equalized rain screen insulated structure technique (PERSIST).
- B. PERSIST wall assemblies shall consist of the following, from exterior to interior:
1. exterior cladding;
 2. air space;
 3. thermal insulation; and
 4. air/vapour barrier system in direct contact with thermal insulation.
- C. Size PERSIST wall cavities to provide minimum 25 mm clearance between insulation and the back of the exterior cladding.
- D. Provide openings in the cladding of PERSIST walls to permit drainage and pressure equalization of the air space.
- E. Compartmentalize air space in the PERSIST wall cavity to restrict air flow around corners and not more than 4 m in any direction within the cavity. Detail and show the location of control joints and compartmentalization baffles in cladding on the applicable Final Designs.

5-1.3.2 Glazed Aluminum Curtain Walls and Glazing Systems

- A. Glazed curtain wall systems (storefronts and entrances) shall comply with the requirements of the American Architectural Manufacturers Association (AAMA) *Aluminum Curtain Wall Design Guide Manual* and the AAMA *Installation of Aluminum Curtain Walls and Aluminum Storefront and Entrance Manual*.
- B. Select glazed curtain wall system components based on systems that capture glass materials using pressure plate securement and having finished cap, or structural silicone glazing profiles.
- C. Select entrance system components compatible with storefront framing, using medium stile profiles that provide extra strength for high traffic door frames and as follows:
 - 1. use door framing components and glazing materials of compatible construction with respect to wall type, envelope continuity and integrity, drainage, and thermal performance as provided for the storefront assembly; install tempered glass in entrances meeting requirements of CAN/CGSB 12.1;
 - 2. equip one set of swing doors at each entrance location with low energy swing operator activated by accessible push button;
 - 3. provide entrance manufacturer's heavy duty door closers, exit hardware, thresholds and architectural push/pulls; and
 - 4. equip lockable hardware with interchangeable cores set in mortise lock bodies.
- D. Solar gain and energy emissivity characteristics for glazing systems provided at Davies Station, the Churchill Connector, and the Gerry Wright OMF shall be optimized with the surrounding building envelope assemblies, building mechanical systems, and inherent thermal capacitance and the respective underlying structural mass so as to prevent:
 - 1. frost and condensation accumulation on interior window assembly surfaces in winter to a minimum ambient outdoor air (dry bulb) temperature of -20°C; and
 - 2. excess internal passive solar gain in summer to a maximum allowable interior mean radiant temperature of +30°C.

5-1.3.3 Roofs – General

- A. Roofs, including eaves troughs and downspouts, shall be designed to prevent snow and ice falling onto areas below, which are accessible to persons or vehicles. Snow guard systems, where used, shall form part of a complete solution of the functional roofing assembly, with all components supplied by one manufacturer.
- B. Roofs shall be designed to include fully integrated and wholly compatible fall protection roof assemblies meeting the requirements set out by the Alberta Occupational Health & Safety Code and forming a permanent part of the roof structure.
- C. Roof drainage slopes shall be formed within the structure only.
- D. Soffits of roofs with exposed structures shall be no lower than the supporting structure.

5-1.3.4 Standing Seam Metal Roofing

- A. Standing seam metal roofing shall comply with the requirements of the:

1. Canadian Sheet Steel Building Institute (CSSBI), CSSBI 20M, *Sheet Steel Cladding for Architectural, Industrial and Commercial Building Applications*; and
 2. Alberta Roofing Contractors Association (ARCA), *Roofing Practices Manual, Architectural Metal Roofing*.
- B. Install standing seam metal roofing flashings, expansion control joints, and other detailing in accordance with Sheet Metal and Air Conditioning Contractors' National Association (SMACNA), *Architectural Sheet Metal Manual*.
- C. The maximum deflection of standing seam metal roofing shall not exceed 1/180 of the span under system weight, snow load, and wind and suction loads acting normal to the plane in accordance with ABC.
- D. Sheet metal roofing system components including metal roof panels, cleats, clips, anchors and fasteners, sheet metal flashing integral with sheet metal roofing, fascia panels, trim, underlayment, and accessories are required to perform without failure and remain water and weather tight for the Design Service Life of the building.

5-1.3.5 Doors

- A. Doors accessible to the public shall have a clear width of at least 910 mm.

5-1.3.6 Slip Resistance of Flooring

- A. Flooring, including Platforms and all sidewalks and SUPs of the Project, shall be slip resistant with the following minimum dynamic coefficients of friction for dry or wet conditions, whichever is more restrictive:
1. publically accessible surfaces with slopes less than or equal to 2.5%: 0.6;
 2. publically accessible surfaces with slopes greater than 2.5%: 0.8;
 3. stairs: 0.8; and
 4. non-publically accessible surfaces: 0.5.
- B. The slip resistance of floors shall be determined in accordance with ANSI A137.1 when tested using the BOT-3000 Digital Tribometer 0.45 dry or wet in accordance with DIN 51130 with R9 Class Slip Resistance for wet or sloping surface.

5-1.3.7 Bird Control Devices

- A. Canopies, abutment seats and other potential bird roosting areas shall be designed to discourage bird roosting and be integrated into the overall design of the element and the surroundings.
- B. Bird control devices, where provided, shall permit removal and reinstallation without damage to the installation surface, bird control device or mounting system.
- C. Mounting hardware, including clips and brackets, of bird control devices shall be concealed from view, when viewed from any public spaces.

SECTION 5-2– STOPS AND STATIONS

5-2.1 INTRODUCTION

5-2.1.1 General

- A. This Section 5-2 [*Stops and Stations*] sets out the general architectural requirements for the Design and Construction of all Stops and Stations.
- B. Wherever the term “Stops and Stations” is used in this Section 5-2 [*Stops and Stations*] of this Schedule, it includes all eleven (11) Stops, Davies Station and the Churchill Connector, unless noted otherwise.

5-2.1.2 Performance Requirements

- A. Stops and Stations shall be designed and constructed to:
 - 1. be fully accessible to provide unimpeded and natural flow for Passengers and pedestrians;
 - 2. be welcoming and comfortable spaces;
 - 3. provide a safe environment; and
 - 4. integrate fully into their urban context.

5-2.1.3 Key Information for Stops and Davies Station

- A. The following key information for the Stops and the Davies Station is specified in Table 5-2.1.3 [*Key Information for Stops and Stations*] of this Schedule.
 - 1. Stop/Station name;
 - 2. type: at-grade or elevated;
 - 3. configuration: side-loading Platform, split side-loading Platform, or centre-loading Platform as defined in Sections 5-2.8.1 [*Side-Loading Platforms*] and 5-2.8.2 [*Centre-Loading Platforms*] of this Schedule;
 - 4. Canopy type: Urban, Neighbourhood, or special case as set out in Section 2-10.2.3 [*Canopies*] of this Schedule;
 - 5. entraining peak load as defined in NFPA 130; and
 - 6. any required special conditions.

Table 5-2.1.3 – Key Information for Stops and Stations

Stop/Station Name	Type	Configuration	Canopy Type	Entraining Peak Load (PPHPD)		Special Conditions
				South-Eastbound	North-Westbound	
102 Street Stop	At-Grade	Side-Loading or Centre-Loading	Urban	2,000 AM 3,000 PM	2,000 AM 3,000 PM	North Platform integrated with sidewalk for side-loading configuration; Terminus Stop
Churchill Stop	At-Grade	Side-Loading	Urban	2,000 AM 3,000 PM	2,000 AM 3,000 PM	North Platform integrated with sidewalk; Connection below-grade to the Existing Churchill Station via the Churchill Connector
Quarters Stop	At-Grade	Side-Loading	Urban	200 AM 300 PM	400 AM 400 PM	South Platform integrated with sidewalk
Muttart Stop	At-Grade	Side-Loading	Neighbourhood	200 AM 1,000 PM	200 AM 1,000 PM	Stair from grade to north access of west Platform; PM peak load refers to a Special Event
Strathearn Stop	At-Grade	Side-Loading	Neighbourhood	200 AM 100 PM	700 AM 200 PM	N/A
Holyrood Stop	At-Grade	Split Side-Loading	Neighbourhood	100 AM 100 PM	400 AM 200 PM	N/A
Bonnie Doon Stop	At-Grade	Side-Loading	Neighbourhood	300 AM 500 PM	1,000 AM 400 PM	N/A

Stop/Station Name	Type	Configuration	Canopy Type	Entraining Peak Load (PPHPD)		Special Conditions
				South-Eastbound	North-Westbound	
Avonmore Stop	At-Grade	Split Side-Loading	Neighbourhood	100 AM 100 PM	200 AM 200 PM	N/A
Davies Station	Elevated	Side-Loading or Centre-Loading	Special Case	200 AM 400 PM	1500 AM 500 PM	Integrated with Davies Transit Centre and Davies Park'n'Ride
Millbourne/Woodvale Stop	At-Grade	Side-Loading	Neighbourhood	200 AM 100 PM	600 AM 200 PM	N/A
Grey Nuns Stop	At-Grade	Side-Loading	Neighbourhood	100 AM 100 PM	400 AM 500 PM	N/A
Mill Woods Stop	At-Grade	Centre-Loading	Neighbourhood	500 AM 500 PM	3000 AM 1000 PM	Terminus Stop

5-2.2 APPLICABLE CODES, STANDARDS AND REGULATIONS

- A. Without limiting Section 1-1.7 [Reference Documents] of this Schedule and except as otherwise specified herein, Stops and Stations and all associated equipment, components, materials, systems and sub-systems shall comply with the following codes, standards and regulations:
 - 1. ABC;
 - 2. CSA B651-12: Accessible Design for the Built Environment;
 - 3. NFPA 130: Standard for Fixed Guideway Transit and Passenger Rail Systems;
 - 4. NFPA 101: Life Safety Code; and
 - 5. Barrier-Free Design Guide, Alberta Safety Codes Council.

5-2.3 STOP AND STATION EGRESS

- A. Egress at all Stops and at Davies Station shall comply with NFPA 130, based on the entraining loads specified in Table 5-2.1.3 [Key Information for Stops and Stations] of this Schedule and a link load/detraining load of the greater of 4,850 PPHPD and the maximum LRV Passenger load.
- B. Provided that the egress capacity of the Existing Churchill Station is not adversely impacted, Project Co shall not be responsible to ensure that the egress capacity of the Existing Churchill Station complies with NFPA 130.

5-2.4 STOP DESIGN VARIABLES

- A. In accordance with Part 2 [SUI] of this Schedule, only the design elements listed in Table 5-2.4 [Stop Design Variables] may vary from Stop to Stop. Stop elements that are not listed in Table 5-2.4 [Stop Design Variables] shall be consistent across all Stops.

Table 5-2.4 – Stop Design Variables

Design Variable
Canopies (as specified in Table 5-2.1.3 [Key Information for Stops and Stations])
Seating/benches
Leaning Rails
Waste and recycling receptacles
Floor/Platform finish
Track slab finish
Handrails
Treatment of glazing (fritting or etching)
Location of Passenger Interface Equipment, signage and CCTV cameras

5-2.5 SIGNAGE

5-2.5.1 General

- A. This Section 5-2.5 [*Signage*] of this Schedule sets out general parameters and requirements for signage at all Stops and Stations. Signage and wayfinding shall contribute to a positive customer service experience for all persons in addition to notifying persons of regulations.
- B. The general design, content, size, colour, typography and mounting height for each type of sign described in this Section 5-2.5 [*Signage*] of this Schedule shall comply with the *Light Rail Transit – Graphic Standards Manual* included in the Disclosed Data.
- C. The use of single purpose free standing poles for the purpose of mounted signage is not permitted unless specified otherwise in Section 5-1 [*General Requirements*] of this Schedule.

5-2.5.2 Wayfinding

- A. Sufficient and clear wayfinding signage shall be provided at all Stops, Davies Station and the Churchill Connector.

5-2.5.2.1 Stop/Station Identification Sign

- A. The purpose of a Stop/Station identification sign is to notify Passengers on the LRV which Stop or Station they are arriving at; therefore, they must be visible from approaching LRVs as they enter the Stop/Station.
- B. Immediately below each Stop/Station identification sign shall be a single line “Route Map” which identifies all of the Stops and Stations along the Valley Line and highlights the Stop/Station on which it is placed.
- C. Notwithstanding the information in Appendix 1 of the *Light Rail Transit – Graphic Standards Manual*, the “No Smoking” and “No Trespassing” pictograms shall not be integrated with the Stop/Station identification sign. “No Smoking” and “No Trespassing” pictograms shall be placed separately within 2 m of each Stop/Station identification sign.
- D. A minimum of three (3) Stop/Station identification signs shall be provided on each Platform:
 - 1. Stop/Station identification signs shall be spaced such that the minimum space between them is not less than 20 m and the distance between the last Stop/Station identification sign and the end of the Platform shall not exceed 30 m;
 - 2. Stop/Station identification signs shall be parallel to the direction of LRV travel; and
 - 3. Stop/Station identification signs shall be double-sided.

5-2.5.2.2 Directional Wayfinding Sign

- A. The purpose of the directional wayfinding sign is to direct alighting Passengers to the end of the Platform in the direction they intend to go.
- B. The primary information included on a directional wayfinding sign shall include:
 - 1. a directional arrow;
 - 2. the closest street, road or avenue and public building or landmark, such as Sir Winston Churchill Square, City Hall or Art Gallery of Alberta;

3. where applicable, the nearest Transit Centre or transfer point, such as the Churchill Connector, or the Davies Transit Centre; and
 4. where required by the ABC, the location of an “Exit”, which shall be identified alongside the general destination.
- C. Provide a minimum of four (4) directional wayfinding signs on each side-loading Platform and a minimum of eight (8) on each centre-loading Platform such that:
1. directional wayfinding signs shall be spaced such that the space between them is not less than 20 m and the distance between the last directional wayfinding sign and the end of the Platform shall not exceed 15 m; and
 2. directional wayfinding signs shall be perpendicular to the direction of LRV travel.
- D. All directional wayfinding signs shall be double sided.
- E. Other information on directional wayfinding signs shall include accessibility information, such as the location of an elevator, or general information, such as the location of a washroom, bus stop or parking.
- F. The first directional wayfinding sign facing Persons entering the Platform at either end of a Stop shall contain at least one (1) “To Trains” pictogram as well as the following text:
1. “Proof of Payment Required Upon Entering Trains”; and
 2. “Purchase or Validate Tickets Using Machines on Platform”.
- G. At Davies Station provide a minimum of one (1) directional wayfinding sign at the bottom of all stairs and escalators on the L1 Ground level indicating the location of elevators accessing the Platform(s).
- H. At Davies Station provide at the bottom of all stairs and escalators on the L2 Mezzanine level and above all elevator doors at the L1 Ground and L2 Mezzanine levels a sign with text: “Entering Proof of Payment Area”.
- I. For side-loading Platforms at Davies Station provide directional wayfinding signs at L2 Mezzanine at stairs, escalators, and elevators indicating north- and southbound Platforms.
- J. Provide a directional wayfinding sign above the doors that separate the Churchill Connector and the Edmonton Pedway system. Directional wayfinding signs shall be mounted immediately above the doors.

5-2.5.3 Regulatory

5-2.5.3.1 No Smoking Signs

- A. The purpose of the “No Smoking” sign is to aid in the enforcement of the City of Edmonton Bylaw 14614 – Public Places Bylaw.
- B. In addition to the pictograms required elsewhere in this section a minimum of one (1) “No Smoking” sign shall be provided at every at-grade entrance to the Davies Station and the Churchill Connector.

5-2.5.3.2 Security Camera Signs

- A. The purpose of the security camera sign is to notify the public that CCTV cameras may be operating along the LRT Corridor, including at the Stops and Stations.

- B. Provide one (1) security camera sign at every Platform Access Point for all Stops and at every entrance to Davies Station and to the Churchill Connector.

5-2.5.4 Information

5-2.5.4.1 Washroom Access Control Signs

- A. The purpose of the washroom access control sign is to provide the necessary instructions to the public on how to get access to the washrooms.
- B. For every public washroom, provide one (1) washroom access control sign.
- C. Washroom access control signs shall be displayed not more than 0.5 meters away from the door to the washroom and shall be next to the washroom access phone specified in Section 6-1.14 [Telephones] of this Schedule.

5-2.5.4.2 Elevator Service Information Board

- A. The purpose of the elevator service information board is to provide the necessary information to the public in case of an interruption in elevator service.
- B. Provide one (1) elevator service information board for every elevator door installed as part of the Project.
- C. The elevator service information board shall be located not more than 0.5 metres from the elevator doors.

5-2.5.4.3 Room Identification Signs

- A. The purpose of the room identification sign is to provide information about the room's functions.
- B. Provide each door to a room within Davies Station and the Churchill Connector with a room identification sign identifying the contents and/or function of the room.

5-2.5.4.4 Transit Watch Information Sign

- A. The purpose of the transit watch information sign is to provide a phone number that can be used to reach the transit help desk for the purpose of aiding in the safety and security of transit users.
- B. Provide one (1) transit watch information sign at every Platform Access Point for all Stops and at every entrance to the Davies Station and to the Churchill Connector.

5-2.5.5 Accessibility

5-2.5.5.1 Automatic Door Signs

- A. The purpose of the automatic door sign is to identify to the public which doors are automatic.
- B. Provide at least one (1) automatic door sign at every automatic door indicating that it is an automatic door.

5-2.5.6 Safety

5-2.5.6.1 Emergency Phone Sign

- A. The purpose of the emergency phone sign is to identify the location of an emergency phone to facilitate locating it for persons in distress.

- B. Provide emergency phone signs indicating the location of each emergency telephone ("blue light phone").
- C. The number and placement of the emergency phone signs shall ensure that at least one (1) sign is visible from all points on the applicable Platform.

5-2.5.6.2 Security Camera Identification Sign

- A. The purpose of the security camera identification sign is to allow security and persons in danger to identify their exact location at a Stop, within Davies Station or within the Churchill Connector.
- B. Provide one (1) security camera identification sign for every CCTV camera installed as part of the Project, displaying the identification reference of the applicable camera, pursuant to Section 6-1.12.2.B.1 [*System Requirements*] of this Schedule.
- C. The security camera identification sign shall be supported from above and be legible from both sides.
- D. The security camera identification sign shall be located not more than 250mm from the camera.

5-2.5.6.3 Escalator Safety Sign

- A. The purpose of the escalator safety sign is to increase the public's escalator safety awareness.
- B. Provide a minimum of one (1) escalator safety sign at the top and bottom of every escalator.
- C. Escalator safety signs shall be mounted:
 - 1. to the interior rail of the escalator; or
 - 2. at a distance not greater than 1.0m from the bottom of the escalator at a nominal height of 1.5m above ground.

5-2.5.6.4 In Case of Fire – Do Not Use Elevator sign

- A. The purpose of "In Case of Fire – Do Not Use Elevator" sign is to advise persons not to use the elevator in case of a fire.
- B. Provide a minimum of one (1) "In Case of Fire – Do Not Use Elevator" sign for each elevator, mounted at a distance not greater than 0.5m from the elevator door at nominally 1.5m above ground.

5-2.5.7 Schedule Boards

- A. Provide wall space:
 - 1. within the heated waiting area at the ground level of Davies Station for a minimum of five (5) schedule boards; and
 - 2. in the at-grade sub-vestibule of the Churchill Connector for a minimum of one (1) schedule board.
- B. Schedule boards shall be placed in such a way that:
 - 1. queuing does not negatively impact pedestrian flow; and
 - 2. they are easily accessed by persons.
- C. Schedule boards shall not be placed on any transparent or translucent surfaces.

- D. Each schedule board shall be 690mm tall by 890mm wide.
- E. Schedule boards will be provided by ETS and shall be installed by Project Co.
- F. Access to the schedule boards shall be provided to ETS for the regular replacement of the bus routes and schedule signage.

5-2.6 SURGE AND QUEUING SPACES

- A. Provide the amount of surge and queuing areas required to meet the peak loads from Table 5-2.1.3 *[Key Information for Stops and Stations]* of this Schedule at each Stop and Station and as follows:
 - 1. surge area provided at the top and bottom of escalators shall be a minimum of 4m long multiplied by the width of the escalator;
 - 2. surge area provided at the top and bottom of public stairs shall be a minimum of 4m long multiplied by the width of the stair;
 - 3. surge area in front of an elevator shall conform to the British Columbia Safety Authority Directive D-L4 090722 2, with a minimum length of at least 3.5m, and shall not impede Passenger and pedestrian flow for non-elevator users; and
 - 4. queuing area provided at Ticket Vending Machines (TVM) shall be a minimum of 3m long in any direction and 1.5m wide and shall not impede Passenger and pedestrian flow for non-TVM users.

5-2.7 SLIP RESISTANCE OF FLOORING

- A. Flooring and Platforms shall be slip resistant according to Section 5-1.3.6 *[Slip Resistance of Flooring]* of this Schedule.

5-2.8 PLATFORMS AND PLATFORM AMENITIES

5-2.8.1 Side-Loading Platforms

- A. A side-loading Platform provides access to a single Track; two side-loading Platforms facing each other are referred to as “Side-Loading” in the “Configuration” column in Table 5-2.1.3 *[Key Information for Stops and Stations]*; two side-loading Platforms that are split across an intersection are referred to as “Split Side-Loading” in the “Configuration” column in Table 5-2.1.3 *[Key Information for Stops and Stations]* of this Schedule.
- B. A side-loading Platform shall have a minimum width of 4.0m from the trackside Platform edge to the outside curb/barrier Platform edge, or to the transition to a sidewalk or a building face.

5-2.8.2 Centre-Loading Platforms

- A. A centre-loading Platform is located between two Tracks and provides access to both Tracks.
- B. The minimum width of a centre-loading Platform is 9.0m from edge of Platform to edge of Platform.

5-2.8.3 General Platform Requirements

5-2.8.3.1 General

- A. Where a Platform is integrated with a sidewalk, as per Section 5-2.12.2B.1 *[102 Street Stop]*, Section 5-2.12.3B *[Churchill Stop]* and Section 5-2.12.4B *[Quarters Stop]* of this Schedule, the entire width of the Platform/sidewalk shall be considered to be the Platform.

5-2.8.3.2 Platform Length

- A. Platform lengths shall be sufficiently long to accommodate the longest Train required to operate at the Maximum Service Level, and shall not be less than 90m.

5-2.8.3.3 Platform Height

- A. The Platform height as measured from top of closest Track rail shall not exceed 360mm.

5-2.8.3.4 Platform Cross-Fall

- A. The cross-fall of the Platform shall slope down and away from, and be perpendicular to, the trackside Platform edge.
- B. The Platform cross-fall shall be between 1.25% and 2.50%.
- C. Water from Platforms shall not:
 - 1. ingress into buildings that are adjacent to the Platform; or
 - 2. pond on the Platform.

5-2.8.3.5 Platform Horizontal Clearance to LRV

- A. Refer to Section 7-1.6.3 [*Platform/LRV Interface*] of this Schedule for the horizontal clearance requirements between the Platform and the LRV.

5-2.8.3.6 Platform Edge Tactile Attention Indicator

- A. Trackside Platform edges shall be provided with a tactile attention indicator in compliance with CSA B651.

5-2.8.3.7 Platform Configuration and Functional Zones

- A. Provide a Pedestrian Clear Width on every Platform, such that the Pedestrian Clear Width:
 - 1. is the width on a Platform into which no elements must intrude unless they are outside a clearance height of 3.0m measured from top of Platform to the underside of the element;
 - 2. shall be at least 2.1m wide, as shown in Figure 5-2.8.3 [*Stop Platform Functional Layout*] of this Schedule; and
 - 3. shall be at least 3.0m wide in areas:
 - a. where the length of an obstruction extending within 3.0m of the trackside Platform edges exceeds 6.0m measured along the Platform; or
 - b. where the clear space between adjacent obstructions extending within 3.0m of the trackside Platform edges is smaller than 3.5m.
- B. The underside of all hanging elements shall be built to a constant datum along the entire length of a Platform.
- C. Configuration of Stop Platform elements shall be symmetrically arranged and mirrored across the short centerline of the Platform.
- D. Canopies, Shelters, Protection Railings and handrails shall be placed as shown in Figure 5-2.8.3 [*Stop Platform Functional Layout*] of this Schedule.

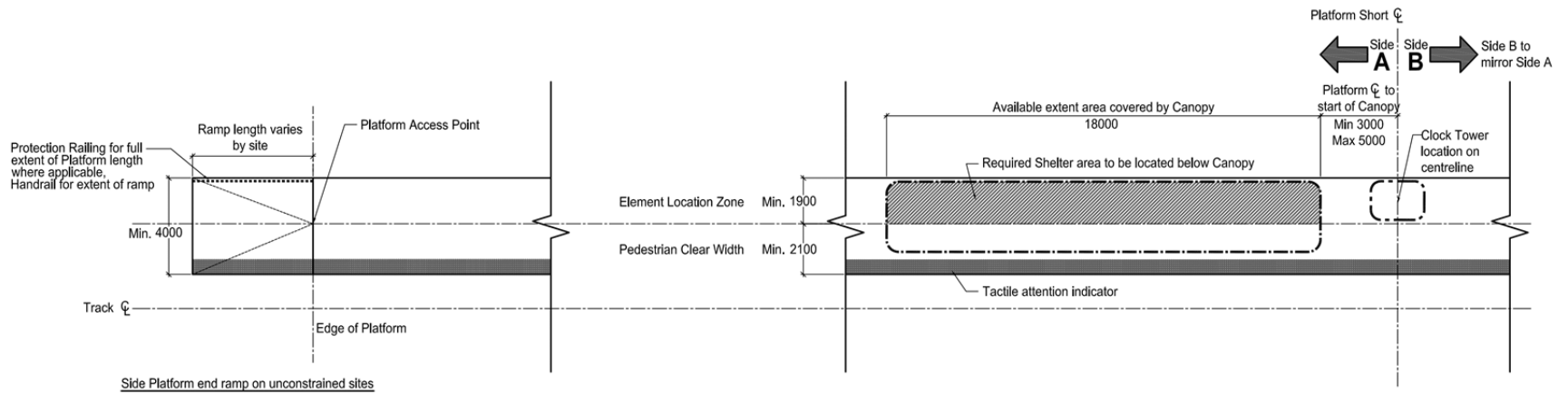
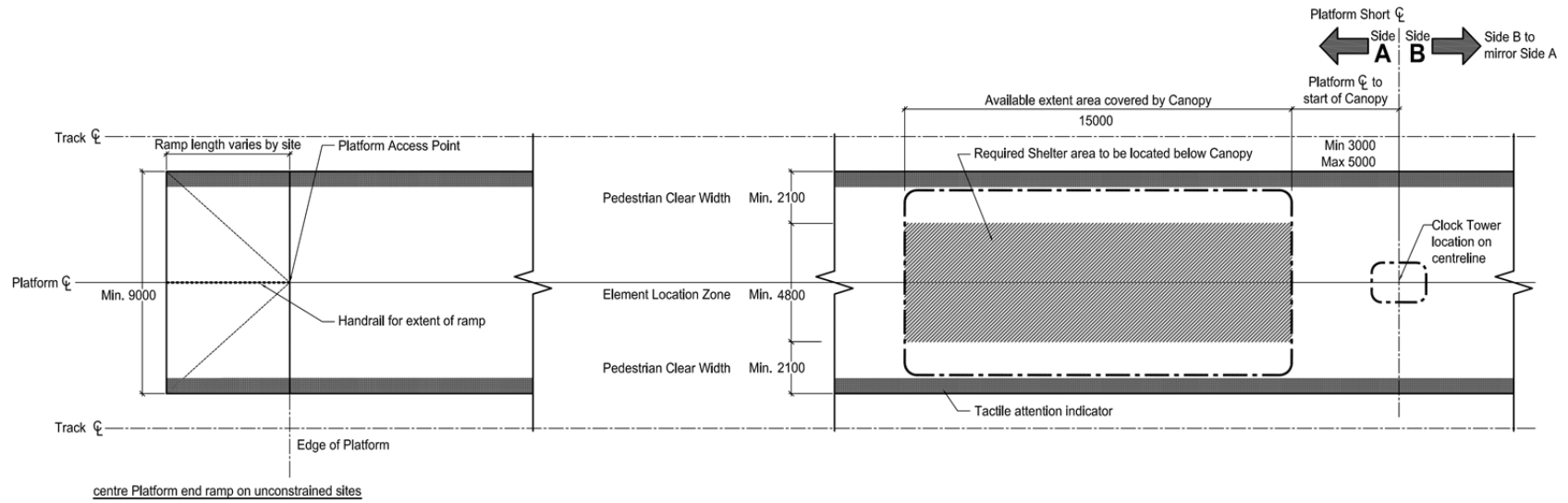

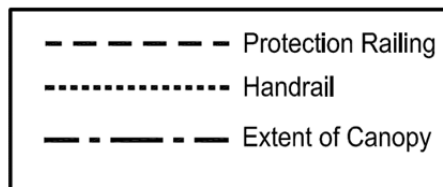
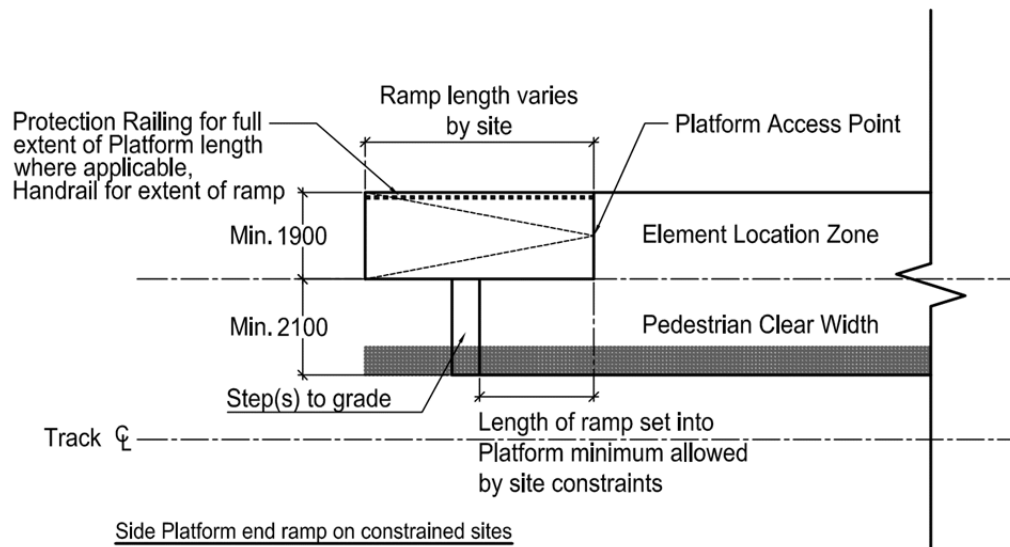

Figure 5-2.8.3: Stop Platform Functional Lay-Out

5-2.8.4 On-Platform Poles

- A. No poles exceeding 4.5m in height, measured from top of Platform to the top of the pole, shall be permitted on Platforms.

5-2.8.5 Access to Existing Buildings

- A. Where a Platform abuts an existing building, all existing building access points shall remain open and unobstructed at all times, except that they may be temporarily closed during Construction subject to Section 4 [*Land Matters*] of the Agreement.
 - 1. Existing barrier free access points shall be maintained, except that they may be temporarily closed during Construction subject to Section 4 [*Land Matters*] of the Agreement.

5-2.8.6 Canopies

- A. A Canopy is a refuge space located on a Platform, having a roof cover, but being open on all four vertical sides; Canopies do not include roofs over TVM's and Information Panels.
- B. Provide Canopies at each Stop and Davies Station; refer to Table 5-2.1.3 [*Key Information for Stops and Stations*] of this Schedule for Canopy type ("Urban", "Neighbourhood" or "special case") and to Section 2-10.2.3 [*Canopies*] of this Schedule for the requirements for each type.
- C. Each side-loading Platform shall have a minimum of 125m² of floor area covered by Canopies.
- D. Each centre-loading Platform shall have a minimum of 170m² of floor area covered by Canopies.
- E. Canopies shall be rectangular in plan.
- F. All Canopies on Stop Platforms shall:
 - 1. be located within the extents shown in Figure 5-2.8.3 [*Stop Platform Functional Layout*] of this Schedule;
 - 2. have a maximum height of 3.8m from top of Platform to the underside of structure; and
 - 3. cover the entire Platform width to at least within 300mm of the trackside Platform edge.

5-2.8.7 Shelters

- A. A Shelter is a fully enclosed refuge space on a Stop Platform, including roof cover, located under a Canopy.
- B. Provide at least four (4) Shelters on each side-loading Platform and at least six (6) Shelters on centre-loading Platforms.
- C. The Shelter enclosure shall be glass.
- D. Each Shelter shall have a minimum useable floor area of 6.5m².
- E. Shelters shall be rectangular in plan, with a short interior dimension of at least 1.6m.
- F. Each Shelter shall be complete with an automatic sliding door, which:
 - 1. shall meet the accessibility requirements of CSA B651;
 - 2. shall face the Track that it serves;

3. shall be activated through push buttons;
 4. shall automatically open in case of a door malfunction; and
 5. may be open at all times at ambient temperatures above 20°C.
- G. On centre-loading Platforms the Shelter doors shall alternate such that there are an equal number facing each Track.
- H. Each Shelter shall provide seating for at least three (3) persons and space for at least one Reference Wheelchair.

5-2.8.8 Seating

- A. Provide seating for at least twenty-four (24) persons on each side-loading Platform and for at least thirty-six (36) persons for each centre-loading Platform, including the seating in the Shelters, meeting the requirements of Section 2-10.2.5 [*Seating*] of this Schedule.
- B. Benches shall include seat, back, end arms and arms between each seat, except that seating in Shelters need not have backs.

5-2.8.9 Leaning Rails

- A. Provide leaning rails within each Shelter enclosure on the side opposite of the automatic doors, except for areas occupied by seating.
- B. In addition to the leaning rails in the Shelters provide at least:
 1. six (6) leaning rails, each having a minimum length of 1.5m, along the non-trackside Platform edge of each side-loading Platform; and
 2. eight (8) leaning rails, each having a minimum length of 1.5m, in the centre of each centre-loading Platform; orientation of the leaning rails shall alternate such that there are an equal number facing each Track.
- C. Leaning rails shall comply with the requirements set out in Section 2-10.2.6 [*Leaning Rails*] and Section 5-2.11.5 [*Leaning Rails*] of this Schedule.

5-2.8.10 Waste and Recycling Receptacles

- A. Provide at least two (2) sets of waste and recycling receptacles on each Platform, meeting the requirements of Section 2-10.2.7 [*Waste and Recycling Receptacles*] of this Schedule.
- B. Receptacles shall:
 1. accommodate at least two throughput streams: “waste” and “recyclables”; and
 2. incorporate removable covers over openings.

5-2.8.11 Passenger Interface Equipment

5-2.8.11.1 General

- A. Passenger Interface Equipment shall be located on the Platforms in such a way that:
 1. a Person standing at the Platform Access Point, to which the Passenger Interface Equipment is closest, has an unobstructed view to the face of the Passenger Interface Equipment; and

2. it does not impede Passenger flow on the Platform.
- B. Locate TVMs, Validators, Information Panels, ETS TV screens, and corporate advertising such that they are accessible for maintenance by authorized City Persons without disrupting Operations.
 - C. TVMs, Validators, Information Panels, and corporate advertising shall be placed so that water draining on the Platform does not degrade their bases.

5-2.8.11.2 Ticket Vending Machines

- A. Provide TVM infrastructure in accordance with Section 6-1.18 [*Ticket Vending Machine Infrastructure*] of this Schedule.
- B. Locate two (2) TVMs back to back and perpendicular to the Track in the longitudinal centre of each Platform, except:
 1. on Platforms integrated with a sidewalk, TVMs may be located side by side and parallel to the Track;
 2. at the Churchill Stop north Platform, locate four (4) TVMs conveniently placed for Passenger flow;
 3. at Davies Station, locate a total of eight (8) TVMs conveniently placed for Passengers in the heated waiting areas at the ground and L2 Mezzanine levels with a minimum of two (2) at the L2 Mezzanine level; no TVMs need to be located on the Platforms;
 4. at the Churchill Connector, locate two (2) TVMs at the below-grade landing area;
 5. at Mill Woods Stop, locate two (2) sets of two (2), for a total of four (4), TVMs in the transverse centre of the Platform; one (1) set within 20m of the east Platform Access Point and one (1) set within 20m of the west Platform Access Point; and
 6. at 102 Street Stop for a centre-loading Platform, locate two (2) sets of two (2), for a total of four (4), TVMs in the transverse centre of the Platform; one (1) set within 20m of the east Platform Access Point and one (1) set within 20m of the west Platform Access Point.
- C. Provide a roof with a plan area that extends 450mm from the front face of each TVM and glass screen walls on two sides extending from ground to the roof along the entire roof length.

5-2.8.11.3 Validators

- A. Provide Validator infrastructure in accordance with Section 6-1.18 [*Ticket Vending Machine Infrastructure*] of this Schedule.
- B. Locate two (2) Validators on each Platform within 10m of each Platform Access Point, spaced at a minimum of 3m, except:
 1. at 102 Street Stop for side-loading Platforms and at Churchill Stop, locate two (2) additional Validators within 5m of a TVM at each Platform;
 2. at 102 Street Stop for centre-loading Platform, locate four (4) Validators within 5m of each set of TVMs, for a total of eight (8) Validators;
 3. at Davies Station, locate a total of ten (10) Validators conveniently placed for Passengers in the heated waiting areas at the ground and L2 Mezzanine levels and on the Platforms; and
 4. at Mill Woods Stop, locate four (4) Validators within 5m of each set of TVMs, for a total of eight (8) Validators.

5-2.8.11.4 Variable Message Signs

- A. Provide VMS in accordance with Section 6-1.21.2 [*Variable Message Signs*] of this Schedule.
- B. Provide a minimum of two (2) VMS's on each Platform for each Track that a Platform serves, placed such that:
 - 1. it is clear as to which Track each VMS serves;
 - 2. the minimum spacing between VMSs is not less than 30m;
 - 3. each VMS is supported from above, perpendicular to the Tracks; and
 - 4. at least one VMS is legible from anywhere on the Platform.
- C. In addition to the requirements of Section 5-2.8.11.4B [*Variable Message Signs*], at Davies Station provide:
 - 1. one (1) VMS at each decision point where a common path of travel divides between the two Platform destinations; the VMS shall indicate the destination of the next Train for each travel path available;
 - 2. a minimum of one (1) VMS above every elevator door at the L1 Ground level and L2 Mezzanine level that indicates the destination of the next Train stopping at the Platform serviced by the elevator; and
 - 3. a minimum of one (1) VMS, centrally located at the bottom of each stair/escalator at the L2 Mezzanine level that indicates the destination of the next Train stopping at the Platform serviced by that stair/escalator.

5-2.8.11.5 Information Panels

- A. Provide two (2) Information Panels per Platform in accordance with Section 6-1.19.4 [*Information Panels*] of this Schedule.
- B. Information panels shall comply with Figure 10.9 of the *City of Edmonton LRT Design Guidelines, 2011*, except that they shall be one-sided only for all side-loading Platforms, i.e., the "rear elevation" in Figure 10.9 of the *City of Edmonton LRT Design Guidelines, 2011* shall be located immediately next to the "front elevation".
- C. Information Panels on Stop Platforms shall be protected by a roof having the same architectural language, form and material as the Canopies at the applicable Stop and a minimum plan area of 4.2m².
- D. All electrical equipment on Platforms shall be located in no more than four (4) cabinets, which shall be fully integrated with the Information Panels, with a maximum of one (1) cabinet per Information Panel, except for centre-loading Platforms, where a maximum of two (2) cabinets per Information Panel are permitted.
- E. Information shown on the Information Panels will be provided by the City. Provide access to the Information Panels for the regular replacement of the information by the City.
- F. Information Panels shall be located within 20m of each Platform Access Point for all Stops and within 20m of each Davies Station Platform Entrance.

5-2.8.11.6 Global Wayfinding Maps

- A. Global Wayfinding Maps will be provided by the City and shall be installed by Project Co.
- B. Global Wayfinding Maps will be nominally 0.6m (wide) x 2.4m (high) x 0.15m (thick) and will be without openings from ground to their nominal height as shown in Figure 5-2.8.11.6 [*Global Wayfinding Map*].

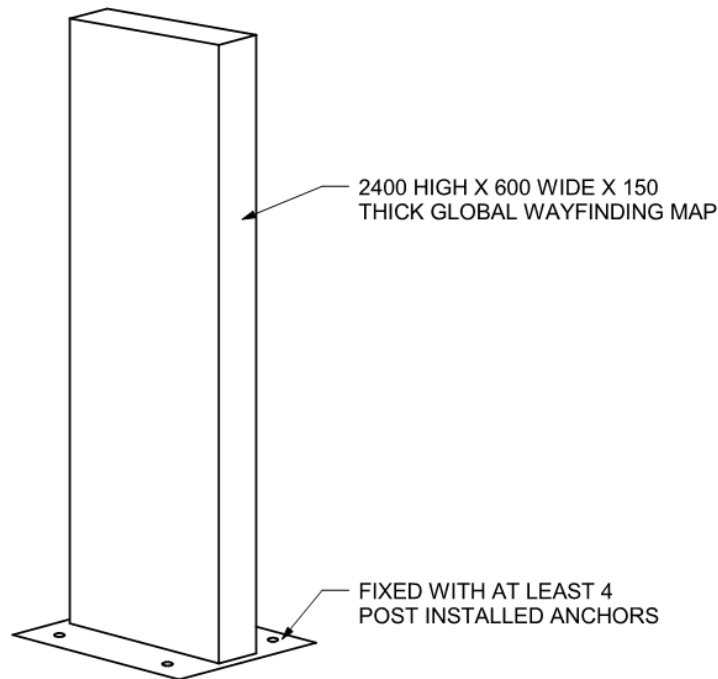

Figure 5-2.8.11.6 - Global Wayfinding Map

- C. Global Wayfinding Maps will be free standing and fixed at the bottom with at least four (4) post-installed anchors.
 - 1. Project Co shall determine anchor requirements, including type, size, number, and embedment of anchors, and shall coordinate attachment points with the City.
 - 2. Global Wayfinding Maps shall be placed so that they are viewable from both sides.
- D. Locate one (1) Global Wayfinding Map not more than 10m from:
 - 1. each Platform Access Point on every Stop Platform; and
 - 2. every at-grade entrance/exit outside of Davies Station and the Churchill Connector.
- E. Replacement and updating of information displayed on the Global Wayfinding Maps will be performed by Other Contractors.
- F. Provide systems infrastructure to each Global Wayfinding Map in accordance with Section 6-1.19.3 [*Global Wayfinding*] of this Schedule.

5-2.8.11.7 ETS TV screens

- A. ETS TV screens, will be supplied and installed by the City.
- B. Provide systems infrastructure to each ETS TV screen in accordance with Section 6-1.19.1 [*ETS TV Screens*] of this Schedule.
- C. Locate systems infrastructure for:
 - 1. two (2) sets of back to back ETS TV screens, for a total of four (4) ETS TV screens on each side-loading Platform; and
 - 2. two (2) sets of two (2) pairs of back to back ETS TV screens, for a total of eight (8) ETS TV screens on each centre-loading Platform, and such that each set shall have a pair of back to back ETS TV screens at the same location along the length of the Platform with one pair for each Track that the Platform serves.
- D. Sets of ETS TV screens shall be:
 - 1. spaced at no less than 30m and no more than 45m;
 - 2. suspended from the Canopy; and
 - 3. perpendicular to the Tracks.
- E. The Canopy structure shall be designed and constructed to support all loads from the ETS TV screens, including wind loads on the screens, assuming the following for each set of ETS TV screens:
 - 1. dimensions of 1390mm (width) x 990mm (height) x 250mm (depth); and
 - 2. weight of 200kg, including mounting devices.

5-2.8.11.8 Corporate Advertising Screens

- A. Corporate advertising screens will be supplied and installed by the City.
- B. Provide systems infrastructure in accordance with Section 6-1.19.2 [*Corporate Advertising*] of this Schedule.
- C. Locate systems infrastructure for two (2) corporate advertising screens on each Platform.
- D. Corporate advertising screens shall be:
 - 1. spaced at no less than 45m;
 - 2. located:
 - a. adjacent to the non-trackside Platform edge for side-loading Platforms; and
 - b. in the transverse centre of the Platform for centre-loading Platforms; and
 - 3. parallel to the Tracks.
- E. The corporate advertising screens may be free standing and will be 1800mm (height) x 1200mm (width) x 600mm (depth) with the bottom of the screen nominally 600mm above top of Platform.

5-2.8.12 Clock Tower

- A. Provide one (1) Clock Tower per Stop, except for split side-loading Platforms, where each Platform shall be provided with a Clock Tower.
- B. Clock Towers shall be located:
 - 1. centrally along the length of the Platform at all Stops with its long dimension perpendicular to the length of the Platform;
 - 2. centrally along the width of the Platform at centre-loading Stops; and
 - 3. on the roadside Platform for Stops with non-split side-loading Platforms and where the Trackway is adjacent to the Roadway on one side only.
- C. Clock Towers shall be as shown in Figure 5-2.8.12 *Figure [Clock Tower]* of this Schedule and shall include:
 - 1. ETS brand with the official ETS logo;
 - 2. Stop name;
 - 3. digital alternating time and temperature display, with time accurate to within ± 10 seconds and temperature accurate to within $\pm 1^\circ\text{C}$; using automatic and periodic updates via a received radio signal; and
 - 4. the line name, i.e. "Valley Line", in green – pantone 355.
- D. The structural elements of the Clock Tower shall have the same surface finish and use the same type of steel cross-section as the Canopy on the same Platform.
- E. Clock Tower shall be energized from the nearest "Normal" electrical load centre via embedded conduit.

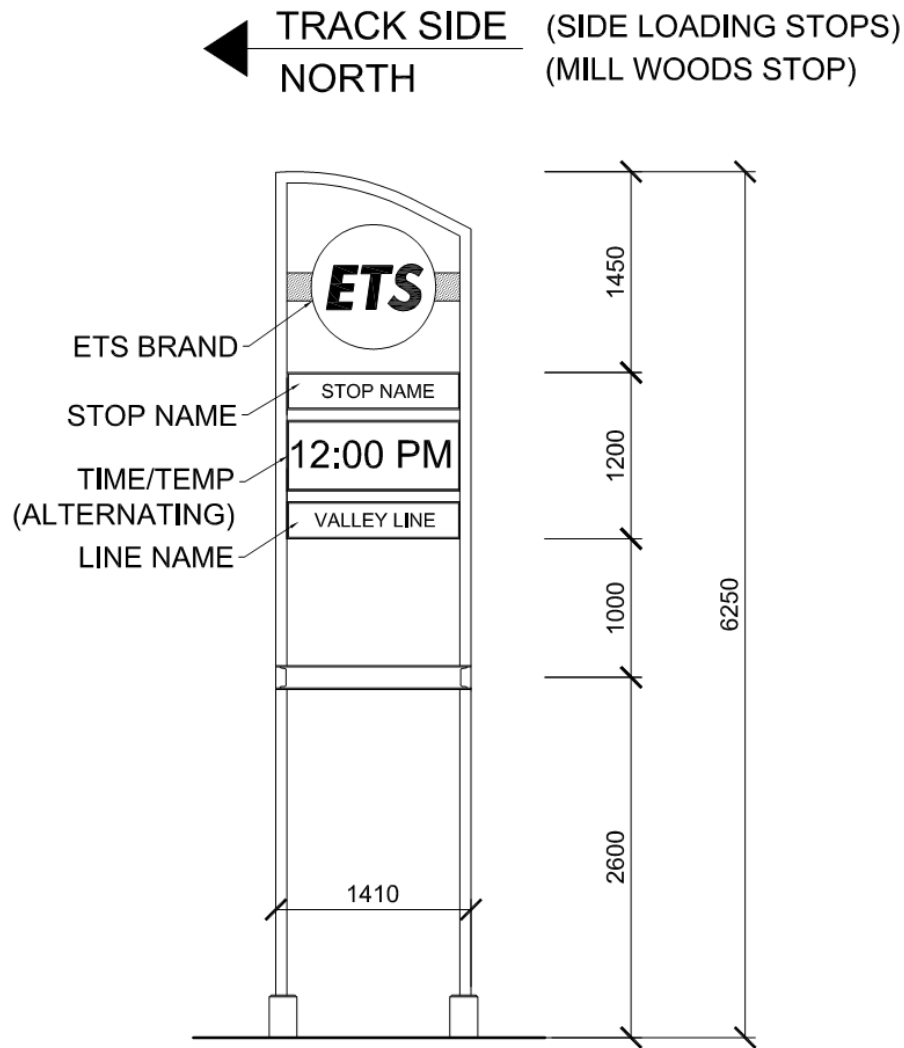

Figure 5-2.8.12: Clock Tower

5-2.8.13 Baseplates

- A. All baseplates and anchors on Platforms shall:
 - 1. be minimized; and
 - 2. not present a tripping hazard.
- B. Exposed anchors with a diameter greater than 16mm are not permitted on Platforms.

5-2.8.14 Non-Trackside Platform Edges

- A. Where the non-trackside Platform edge is adjacent to a sidewalk, an SUP or a landscaped area, no step between the top of Platform and the top of sidewalk, SUP and the landscaped area, respectively, shall be permitted.

5-2.9 ACCESSIBILITY

5-2.9.1 Accessibility to Platforms

- A. Provide a minimum of two (2) Platform Access Points complying with CSA B651 at all Stop Platforms, with at least one (1) at each end of the Platform.
- B. Provide handrails:
 - 1. at the non-trackside Platform edge for side-loading Platforms; and
 - 2. at the centre of centre-loading Platforms,

along the walkway from adjacent grade to the Platform Access Points.

- C. Platform Access Points shall be full width of the Platform and located fully outside the Platform length specified in Section 5-2.8.3.2 [*Platform Length*] of this Schedule.
- D. Where it is not possible to comply with the length requirements in Section 5-2.9.1C [*Accessibility to Platforms*]:
 - 1. Platform Access Points may be inset, longitudinally, but only to the extent necessary and only on the side opposite the trackside edge of the Platform and so as not to encroach on the Pedestrian Clear Width, as illustrated in Figure 5-2.8.3 [*Stop Platform Functional Layout*] of this Schedule;
 - 2. steps with a rise between 120mm and 180mm and a run of at least 250mm shall be provided at the Platform end on the trackside edge; and
 - 3. the tactile attention indicator shall continue down the steps into the refuge area, consistent with Section 2-4.3 [*Crossing Treatments*] of this Schedule.
- E. Walkways leading up to Platform Access Points shall have a slope not exceeding 5%.

5-2.9.2 Vertical Circulation

- A. Provide up-escalators wherever the vertical distance between floor levels exceeds 3.7m and down-escalators wherever the vertical distance between floor levels exceeds 7.3m.
- B. Provide elevators where the vertical distance between floor levels exceeds 1.5m; platform lifts as defined in CSA B651 may be used where the vertical distance between floor levels is between 1.5m and 2.5m.

5-2.10 STORM AND MELT WATER DRAINAGE

5-2.10.1 Canopies and Roofs

- A. Canopies and roofs over Information Panels and TVMs shall shed water away from the trackside Platform edge.
- B. Up to the 1:5 year design event, water runoff from Canopies and roofs shall be collected and discharged into the Stormwater Management System. Dripping of water over Canopy and roof edges is not permitted.

5-2.10.2 Platforms

- A. Up to the 1:5 year design event, water runoff on side-loading Platforms shall be collected at the non-trackside Platform edge and discharged into the Stormwater Management System.

- B. Up to the 1:5 year design event, water runoff on centre-loading Platforms shall be collected at the centre between the two Platform edges and discharged into the Stormwater Management System.
- C. Standing water on Platforms is not permitted up to a 1:100 year design event.

5-2.11 MATERIAL AND COMPONENT REQUIREMENTS

5-2.11.1 Structural Glass

- A. All structural glass at Stops, for the shelters at the Davies Transit Centre and for the glazing walls at the Churchill Connector and Davies Station shall be glass:
 - 1. with a visible transmittance of at least 80% at a wavelength of 550nm;
 - 2. that, when broken, does not cause a Hazard, including no exposed sharp edges; and
 - 3. with vertical elements in Passenger and pedestrian flow areas having visibility fritting to alert persons to the presence of glass.

5-2.11.2 Heavy Timber Construction

- A. This Section 5-2.11.2 [*Heavy Timber Construction*] of this Schedule sets out the requirements for heavy timber framing and decking materials, which includes the following materials, in combination or as individual elements:
 - 1. timber framing or decking materials:
 - a. having a measurement of 115mm or greater in the least dimension or being tongue and groove wood decking measuring 38mm or greater in thickness; and
 - b. using softwood materials such as Douglas Fir-Larch or Hemlock in accordance with National Lumber Grading Association (NLGA), Select Structural Grade or Grade No. 1 appearance selected for architectural finish;
 - 2. engineered timber framing or panels, including shop fabricated glued laminated structural wood and cross laminated timber structural panels fabricated in accordance with CAN/CSA O122 Structural Glued-Laminated Timber and manufactured in accordance with CAN/CSA O177 Qualification Code for Manufacturers of Structural Glued-Laminated Timber.
- B. Fabricate timber connectors from structural stainless or carbon steel meeting the requirements of Section 2-11.2.3 [*Architecturally Exposed Structural Steel*] of this Schedule, using concealed fasteners, and as follows:
 - 1. build up connections from steel plates with square corners; use separate plates with welds ground smooth for off 90° angles. Bent plates are not permitted;
 - 2. grind off surface defects, weld spatter, burrs and sheared edges to a smooth surface appearance, for improved paint bond on all exterior and visually exposed steel work; and
 - 3. use only flush countersunk stainless steel screws or bolts when exposed screw type mechanical fastenings are required.
- C. Finish heavy timber framing to prevent water penetration and atmospheric staining of exposed wood components in accordance with the *Master Painters Institute* requirements for *Premium Grade High Performance Coating System* applied to exterior glue laminated beams and columns as follows:

1. apply semi-transparent stain to balance colour differences of separate components and finish with two (2) clear polyurethane intermediate coats, and single (1) clear polyurethane finish coat; finish coat can be applied after completion of assembly.

5-2.11.3 Steel Doors and Frames

- A. All opaque doors at the Churchill Connector and the Davies Station shall be hollow steel doors with steel frames.
- B. Hollow steel doors and frames shall be manufactured in accordance with *Canadian Steel Door Manufacturers Association (CSDMA)* dimensional standards and installation requirements and shall comply with *CAN/CGSB 82.5 Insulated Steel Doors*.
- C. Fabricate hollow steel doors and frames from galvanized steel of a thickness to resist vandalism.
- D. All fire doors shall comply with the testing requirements of NFPA 80 *Standard for Fire Doors and Other Opening Protectives* and NFPA 252 *Standard Methods of Fire Tests of Door Assemblies* and shall be labelled in accordance with the *CSDMA Fire Labelling Guide*.
- E. Door hardware shall consist of institutional grade ball bearing butts, weather-stripping, thresholds; rim mounted panic devices, door closers, lever handled door knobs, locks and other access controls.

5-2.11.4 Overhead Coiling Grilles

- A. Coiling grilles shall be:
 1. overhead (vertical);
 2. self-opening;
 3. equipped to be remotely monitored and activated from the OCC; and
 4. fabricated from stainless steel having #4 directional satin finish applied to interconnecting rods, links and other exposed components.

5-2.11.5 Leaning Rails

- A. This Section 5-2.11.5 [*Leaning Rails*] of this Schedule sets out the requirements for leaning rails.
- B. Leaning rails shall be:
 1. custom fabricated, using pressure treated FSC (Forest Stewardship Council) sustainably sourced pine wood as the leaning surface;
 2. suitable for use as temporary rest stops for public transit applications in waiting and queue management areas, acting like perched seats with the leaning surface at a nominal height of 900 mm; and
 3. capable of resisting design forces required by ABC.
- C. Fabricate steel support members, posts and supports for all leaning rails from galvanized or stainless steel, with:
 1. galvanizing using a U/V and wear resistant, shop applied powder coat finish in a colour that matches the adjacent Canopy AESS finished components; and

2. details smoothed and dressed in accordance with requirements for AESS.

5-2.11.6 Floor and Wall Tile

- A. All floor and wall tile shall comply with ANSI/CTI A108.1 and A137, ISO 10545 and 13006, and DIN 51130 and shall be installed in accordance with the installation requirements of the *Tile Installation Manual* published by the *Terrazzo, Tile and Marble Association of Canada*.
- B. Provide pre-manufactured trims and profiles to finish edge of floor and wall tile installations.

5-2.11.7 Floor Grilles

- A. Floor grilles in public spaces shall:
 - 1. be stainless steel;
 - 2. be recessed so that grille wearing surface is set flush to adjacent finished floor surfaces;
 - 3. be designed to withstand all applicable loading conditions, without permanent deformation;
 - 4. have gap spacing that prevents capture of parts of footwear, such as stiletto heels;
 - 5. include a drained recessed catchment basin under floor grilles to trap grit, water, snow and other debris; and
 - 6. include heat-tracing for snow and ice melt in all unheated locations.

5-2.11.8 Stairs and Ramps

- A. This Section 5-2.11.8 [*Stairs and Ramps*] of this Schedule sets out the requirements for stairs and ramps in public areas.
- B. Stairs and ramps shall be architectural concrete in accordance with Section 2-11.2.1 [*Concrete Finish*] of this Schedule and shall include:
 - 1. tactile warning strips at all landings, sized and located in accordance with CAN/CSA B651; and
 - 2. treads, risers, ramp slopes and landings sized in accordance with ABC and CAN/CSA B651, with the following minimum clear width between the handrails at the stair edges:
 - a. Churchill Connector stairs from at grade to the below grade landing area: 2.50m;
 - b. Davies Station stairs:
 - i. from heated waiting area L1 Ground to L2 Mezzanine: 3.30m for at least one set of stairs; and
 - ii. from L2 Mezzanine to L3 Platforms: 2.20m for at least one set of stairs to each Platform.

Where handrails, in addition to the handrails at the stair edges, are required by ABC, such handrails are not deemed to reduce the clear width.

- C. Stairs shall have closed risers.

- D. Where stairs are located adjacent to escalators they shall be parallel to the angle of inclination of the escalator and sized to have landings at a common elevation.
- E. Exterior stairway landings shall incorporate floor grilles as set out in Section 5-2.11.7 [*Floor Grilles*] of this Schedule.

5-2.11.9 Passenger Elevators

A. Passenger elevators shall:

- 1. have a minimum:
 - a. capacity of:
 - i. twelve (12) persons; and
 - ii. 1,130kg,
per elevator cabin;
 - b. travel speed of 45 metres per minute; and
 - c. clear width of 2,380mm and clear depth of 1,600mm;
- 2. have side slide doors;
- 3. be manufactured from corrosion and weather resistant materials;
- 4. operate at, or below, 60dBA sound level, measured in the cabin and 1500mm from the elevator at any location with the elevator operating normally, free running or under load at the travelling speed meeting the capacity requirements set out in Section 5-2.11.9A.1 [*Passenger Elevators*]; and
- 5. be accessible from within weather protected areas.

B. Manufacture passenger elevator components from non-combustible materials; use materials having limited flame spread for cab finish materials meeting requirements of CAN/ULC S102 *Standard Method of Test for Surface Burning Characteristics of Building Materials and Assemblies*, and as follows:

- 1. Provide:
 - a. a minimum of 50% of the total elevator cab and hoist-way vertical enclosure surface area in glass;
 - b. vertical applied plastic laminate wall panels applied to baked enamel cab walls for non-glass walls;
 - c. stainless steel full width wrap around cab front with digital signals and audible floor call system;
 - d. suspended down light halogen ceiling panel having a plastic laminate finish;
 - e. 38mm Ø cylindrical handrails on three (3) sides; and
 - f. porcelain tile or other durable, non-absorbent floor finish.

2. Finish entranceways using stainless steel frames and door skins with vandal resistant call buttons, directional lanterns on frames with audible floor announcement; main floor shall have digital floor directory indicating which floor elevator cab is on and direction of travel.

5-2.11.10 Escalators

A. Escalators shall:

1. accommodate at least two (2) people standing or moving side by side;
2. be capable of transporting at least 110 persons per minute at a speed of at least 27 metres per minute;
3. be manufactured from corrosion and weather resistant materials;
4. be manufactured from components meeting design requirements for *Heavy Duty Transportation System Escalator Design Guidelines*, published by the American Public Transportation Association; and
5. operate at, or below, 60dBA sound level, measured 1000mm from the escalator at any location with the escalator operating normally, free running or under load at the travelling speed meeting the capacity requirements set out in Section 5-2.11.10A.2 [Escalators] above.

- B. Provide a minimum of two (2) flat steps at upper and lower landings where vertical rise of an escalator is 6.1m or less and a minimum of three (3) steps at upper and lower landings where vertical rise of an escalator exceeds 6.1m.

5-2.12 STOP/STATION-SPECIFIC DESIGN REQUIREMENTS

5-2.12.1 Introduction

- A. This Section 5-2.12 [Stop/Station Specific Design Requirements] sets out additional Design and Construction requirements applicable to specific Stops and Stations. Each of the Stops and Stations in this Section shall also comply with Sections 5-2.1 [Introduction] to 5-2.11 [Material and Component Requirements] of this Schedule inclusive, except to the extent that these requirements are in conflict, in which case the requirements in this Section shall prevail.

5-2.12.2 102 Street Stop

- A. This Section 5-2.12.2 [102 Street Stop] set outs additional Design and Construction requirements applicable to the 102 Street Stop.
- B. If side-loading Platforms are provided for the 102 Street Stop:
1. the north Platform of the 102 Street Stop shall be integrated with the sidewalk, with no step, rail, or other form of barrier between the trackside Platform edge and the existing building face;
 2. the configuration of the north Platform elements may be non-symmetrical;
 3. the Canopies on the north Platform shall be at least 32m in length, measured in the long dimension of the north Platform, and shall cover at least 100m² of the north Platform:
 - a. the Canopies shall be distributed in at least two (2) discrete areas, at least one (1) of which shall be located on the east side of the Platform centreline, and at least one (1) of which shall be located on the west side of the Platform centreline; and

- b. at least 40%, but not more than 60% of the total coverage shall be provided on the west side of Platform centreline;
- 4. Shelters are not permitted on the north Platform;
- 5. maximize the Pedestrian Clear Width on the north Platform;
- 6. poles exceeding 4.5m in height, measured from top of Platform to the top of the pole, may be placed on:
 - a. the north Platform, provided they are placed as close as practicable to the existing building face; and
 - b. the south Platform, provided they are placed as close as practicable to the non-trackside Platform edge; and
- 7. the cross-fall of the Platforms may slope towards the trackside Platform edge.
- C. If a centre-loading Platform is provided for the 102 Street Stop, the Platform width shall be no less than 6.5m, with the Element Location Zone being no less than 2.3m.

5-2.12.3 Churchill Stop

- A. This Section 5-2.12.3 [*Churchill Stop*] set outs additional Design and Construction requirements applicable to the Churchill Stop.
- B. The north Platform of the Churchill Stop shall be integrated with the sidewalk, with no step, rail, or other form of barrier between the trackside Platform and the existing building face.
- C. Configuration of the north Platform elements may be non-symmetrical.
- D. The Canopy on the north Platform shall be contiguous with the South Pavilion and shall cover at least an area of 15m x 2.2m;
 - 1. Canopy may be fixed to the existing building, subject to Section 4 [*Land Matters*] of the Agreement.
- E. Provide two (2) Shelters, each with a floor area of at least 8m², under the Canopy on the north Platform.
- F. Maximize the Pedestrian Clear Width on the north Platform.
- G. Poles exceeding 4.5m in height, measured from top of Platform to the top of the pole, may be placed on:
 - 1. the north Platform, provided they are placed as close as practicable to the existing building face of the South Pavilion; and
 - 2. the south Platform, provided they are placed as close as practicable to the non-trackside Platform edge.
- H. The cross-fall of the Platforms may slope towards the trackside Platform edge.

5-2.12.4 Quarters Stop

- A. This Section 5-2.12.4 [*Quarters Stop*] set outs additional Design and Construction requirements applicable to the Quarters Stop.

- B. The south Platform of the Quarters Stop shall be integrated with the sidewalk, with no step, rail, or other form of barrier between the trackside Platform edge and the existing building face.
- C. The width of the south Platform of the Quarters Stop:
 - 1. shall be maximized, while complying with the minimum widths for the north sidewalk, the westbound lane and the shy-way between the westbound lane and the north Platform as set out in Section 3-2 *[Roadways, Sidewalks, and Shared Use Paths]* of Schedule 5 *[D&C Performance Requirements]* and the minimum Platform width for the north Platform as set out in Section 5-2.8.1B *[Side-Loading Platforms]* of Schedule 5 *[D&C Performance Requirements]*; and
 - 2. may be less than 4.0m.
- D. Configuration of south Platform elements may be non-symmetrical.
- E. At least 90m² of the south Platform shall be covered by Canopies.
- F. Maximize the Pedestrian Clear Width on the south Platform.
- G. Poles exceeding 4.5m in height, measured from top of Platform to the top of the pole, may be placed on:
 - 1. the north Platform, provided they are placed as close as practicable to the non-trackside edge of the Platform; and
 - 2. the south Platform, provided they are placed as close as practicable to the existing building face.
- H. The cross-fall of the Platforms may slope towards the trackside Platform edge.
- I. Shelters are not required on the south Platform.

5-2.12.5 Muttart Stop

- A. Provide stairs from grade to the north Platform Access Point of the west Platform of the Muttart Stop.

5-2.12.6 Davies Station

- A. This Section 5-2.12.6 *[Davies Station]* set outs additional Design and Construction requirements applicable to the Davies Station.

5-2.12.6.1 Program Requirements

- A. Davies Station shall as a minimum comprise of the rooms and spaces identified in Table 5-2.12.6 *[Davies Station Room Program]*.
- B. Davies Station shall have three (3) levels:
 - 1. a ground floor level integrated with the Davies Transit Centre (L1 Ground);
 - 2. an intermediate mezzanine level (L2 Mezzanine); and
 - 3. a Platform level, with a centre-loading or two (2) side loading Platforms (L3 Platform).

Table 5-2.12.6 – Davies Station Room Program

Description	Minimum Area (m ²)	Minimum Requirements
Heated Waiting Area L1 Ground	360	Seating for at least fifteen (15) persons with armrests between each individual seat
Mezzanine Crossover L2 Mezzanine	340	At least 230 m ² shall be a heated waiting area Seating for at least eight (8) persons with armrests between each individual seat shall be provided within the heated waiting area
Exterior Unheated Waiting Area in Shelters L1 Ground	Refer to Section 2-12 [Davies Transit Centre] of this Schedule	Refer to Section 2-12 [Davies Transit Centre] of this Schedule
Female Operator's Washroom L1 Ground	10	Two (2) toilets, one (1) sink Entrance from the heated waiting area Vandal-resistant fibre reinforced plastic paneling Lighting controlled by motion sensor and timer
Male Operator's Washroom L1 Ground	10	Two (2) urinals, two (2) toilets, one (1) sink Entrance from the heated waiting area Vandal-resistant fibre reinforced plastic paneling Lighting controlled by motion sensor and timer
Retail Kiosk L1 Ground	20	In accordance with the ETS Transit Centre Design Guidelines (May 15, 2012), Section 5.2 Fire rated wall and ceiling materials Retail kiosk shall accommodate kitchen equipment to cook, bake, grill and fry; Project Co to provide rough-ins for all associated ABC requirements for mechanical and electrical systems, including space for associated air handling units and other mechanical and electrical equipment; kitchen equipment will be supplied and installed by the City
Electrical / Communications Room L1 Ground or L2 Mezzanine	10	Secure entrance from the heated waiting area
Janitorial Room L1 Ground or L2 Mezzanine	3	Secure entrance from the heated waiting area

Description	Minimum Area (m ²)	Minimum Requirements
Mechanical Room L1 Ground or L2 Mezzanine	10	Secure entrance from the heated waiting area
Female Public Washroom L1 Ground	10	One (1) toilet, one (1) sink Vandal-resistant fibre reinforced plastic paneling Change table Lighting controlled by motion sensor and timer Full accessibility Powered door operated by ETS Transit Security
Male Public Washroom L1 Ground	10	One (1) toilet, one (1) urinal, one (1) sink Vandal-resistant fibre reinforced plastic paneling Change table Lighting controlled by motion sensor and timer Full accessibility Powered door operated by ETS Transit Security
Security Office L1 Ground	17	Reflective windows to allow for outside viewing from the inside, but no view from outside under any light condition User controlled heating, air conditioning and ventilation Electronic security roller blind Peep-hole door Shelf to accommodate a microwave oven (supplied by the City) at nominally 1 m above finished floor One (1) sink CAT6 network connection to the nearest City Cabinet Vault
Elevator Machine Room L1 Ground or L2 Mezzanine	10	Secure entrance from the heated waiting area
Heated Waiting Area L3 Platform	20 for each side-loading Platform 30 for a centre-loading Platform	If heated waiting area is adjacent to the surge space of a stair, escalator or elevator, a separation between the heated waiting area and the stair/escalator/elevator surge space shall be provided

- C. The ground floor (L1 Ground) shall provide vertical access from the heated waiting area to the mezzanine level (L2 Mezzanine).

- D. Elevator(s) shall provide direct access from L1 Ground to each Platform (L3 Platform), including loading/unloading capabilities for each elevator at L2 Mezzanine.
- E. The building services and each of the following spaces shall be located within a central core on L1 Ground:
 - 1. public and operator washrooms;
 - 2. security office with a vault; the vault shall be as follows:
 - a. nominally 2.45m wide by 1.85m deep;
 - b. reinforced block walls on all sides;
 - c. non-accessible from top;
 - d. security door with dual custody locks, centred on long dimension; and
 - e. a light adequate to permanently illuminate the vault to allow for monitoring the vault with CCTV cameras; and
 - 3. a retail kiosk.
- F. Access to the retail kiosk and the public washrooms shall be in full view of the adjacent waiting and public circulation areas.
- G. No Shelters are required on the Platforms.

5-2.12.6.2 Passenger Circulation Requirements

- A. Access to L2 Mezzanine from the heated waiting area on L1 Ground shall be provided by escalator(s), stairs and elevator(s) in conditioned vertical circulation element.
- B. Access from L2 Mezzanine to L3 Platform shall be provided by stairs, escalator(s) and elevator(s) located in unconditioned, vertical circulation elements.
 - 1. If side-loading Platforms are provided, the vertical circulation elements shall be placed outboard of the Platforms and cantilevered over the Davies Transit Centre.
- C. All vertical circulation elements shall be fully integrated into the overall architecture of Davies Station, and shall be accessible to Passengers during Operating Hours.
- D. Provide connection points suitable for attachment by Other Contractors or a design using piers on the Davies Transit Centre island to accommodate two (2) future enclosed pedestrian bridges, one (1) on each side of the Davies Elevated Guideway, spanning over the Davies Transit Centre loops to future Transit Oriented Development and connecting at the L2 Mezzanine level with direct access off the pedestrian bridges into Davies Station:
 - 1. with the Final Design, provide a detailed design of the piers, including foundations, or of connection points, as applicable; the design shall show how the pedestrian bridges are supported by the piers or attached to the connection points;
 - 2. if the pedestrian bridges are supported on piers, the piers shall be integrated into the overall architecture of Davies Station and not adversely affect pedestrian flows;
 - 3. assume the future pedestrian bridges have an interior clearance box 4.0m wide and 3.0m high;

4. the pedestrian bridges shall be located, such that pedestrians can use the future pedway system to pass from one pedestrian bridge to the other in a direct path at any time, including when the Davies Station is closed;
 5. notwithstanding Section 4-1.9.3 [*Vertical Clearance*] of this Schedule, the minimum vertical clearance between the bus loop and the underside of the pedestrian bridges shall be 4.8m; and
 6. the connection points and structure of Davies Station or the piers shall be designed to accommodate a future factored load per pedestrian bridge of 3000kN.
- E. If side-loading Platforms are provided at Davies Station, design and construct the L3 Platform level such that two (2) fully accessible crossings of the Tracks at each end of the Platforms, each with a minimum width of 1.8m, are provided or can be accommodated in the future.

5-2.12.6.3 General Station Requirements

- A. Davies Station shall be an “Open Station” as defined in NFPA 130.
- B. The full extent of the L3 Platform level in the direction of the Davies Elevated Guideway shall be covered by a Canopy and glazed sidewalls.
 1. A gap between the sidewalls and the Canopy is permitted, provided that such gap does not expose Passengers to the effects of wind, rain, or snow.
- C. Runoff from the Davies Station, up to the 1:100 year design event, shall be:
 1. managed to prevent any impacts on persons on all three levels of Davies Station and on traffic in the Davies Transit Centre; and
 2. collected in eaves trough/downspout systems.
- D. Water ingress into the conditioned spaces on L1 Ground, L2 Mezzanine, and the vertical circulation spaces of Davies Station shall not be permitted under any design event.
- E. Subject to Section 2-14.8.2.3.E [*Area Specific Requirements*] of this Schedule, downspouts from the Davies Station may discharge into the on-site storm system, without resulting in any ponding, ice build-up or other impacts on pedestrians, buses and other users of the Davies Site.

5-2.13 CHURCHILL CONNECTOR

5-2.13.1 Introduction

- A. This Section 5-2.13 [*Churchill Connector*] of this Schedule sets out additional Design and Construction requirements applicable to the Churchill Connector. The Design and Construction of the Churchill Connector shall also comply with Sections 5-2.1 [*Introduction*] to 5-2.11 [*Material and Component Requirements*] of this Schedule inclusive, except to the extent that these requirements are in conflict, in which case the requirements in this Section shall prevail.
- B. The Churchill Connector is an enclosed and heated vertical circulation link between the Churchill Stop and the Existing Churchill Station. The Churchill Connector shall provide direct access from the Churchill Stop to the south and Sir Winston Churchill Square to the north to the Existing Churchill Station. In addition, an unimpeded path of travel must be provided through a sub-vestibule to allow a direct pedestrian path through the building connecting the Churchill Stop and Sir Winston Churchill Square. The sub-vestibule entry also provides access to the Churchill Connector pavilion which contains vertical circulation to the Existing Churchill Station mezzanine level and Pedway system.

- C. The Churchill Connector shall as a minimum comprise of the room and spaces identified in Table 5-2.13.1 [Churchill Connector Room Program].

Table 5-2.13.1 – Churchill Connector Room Program

Description	Minimum Area (m ²)	Minimum Requirements
Churchill Connector Pavilion (At-Grade)	85	Vertical circulation access to the Existing Churchill Station Direct connection and passenger flow to sub-vestibule Open to and interconnected with the two (2) levels of the Churchill Connector Unimpeded visual connections to the Churchill Stop, Sir Winston Churchill Square and 99 Street
Churchill Connector Sub-vestibule (At-Grade)	30	Direct pedestrian flow to and from Sir Winston Churchill Square and the Churchill Stop that does not impede movements to the Churchill Connector pavilion Direct connection and passenger flow to the Churchill Connector pavilion
Landing Area (Below-Grade)	180	Vertical circulation access to the Churchill Connector pavilion Direct connection and passenger flow to the Existing Churchill Station's mezzanine level and the Pedway system Ticket purchasing and validation area Secure entrance to Churchill Connector Utility Complex
Elevator Machine Room (Below-Grade)	4	Secure entrance from below-grade landing area, Pedway, or Churchill Connector Utility Complex corridor
Mechanical and Electrical Room (Below-Grade)	40	Secure entrance from below-grade landing area, Pedway, or Churchill Connector Utility Complex corridor
Utility Complex Corridor (Below-Grade)	65	Provide access to and from Churchill Connector Utility Complex and below-grade landing area
TPSS (if required) (Below-Grade)	N/A	Secure entrance from Churchill Connector Utility Complex corridor
Signals Room (Below-Grade)	9	Secure entrance from Churchill Connector Utility Complex corridor
Electrical Room (Below-Grade)	10	Secure entrance from Churchill Connector Utility Complex corridor
Communications Room (Below-Grade)	12	Secure entrance from Churchill Connector Utility Complex corridor

5-2.13.2 Functional Program

- A. The Churchill Connector shall be designed and constructed in accordance with the functional programs as set out in Figure 5-2.13A [*Churchill Connector Functional Relationship – At-Grade*] and Figure 5-2.13B [*Churchill Connector Functional Relationship – Below-Grade*] and as follows:
1. the Churchill Connector shall be a fully accessible transfer point between the Churchill Stop, the Existing Churchill Station, and the adjoining Pedway system;
 2. at-grade, the Churchill Connector shall be contiguous with the Churchill Stop and Sir Winston Churchill Square;
 3. below-grade, the Churchill Connector shall be contiguous with, and connect directly to, the mezzanine level of the Existing Churchill Station and the below-grade Pedway system; and
 4. the primary functional elements of the Churchill Connector shall be as follows:
 - a. an at-grade, fully enclosed floor level that shall be:
 - i. located directly east of, and abut, the existing South Pavilion; and
 - ii. contain the Churchill Connector pavilion, including surge space for the required vertical circulation between the at- and below-grade levels of the Churchill Connector, and sub-vestibule; and
 - b. a below-grade complex of public and non-public spaces that shall include:
 - i. a landing area containing surge space for the required vertical circulation between the at- and below-grade levels of the Churchill Connector;
 - ii. building services, including storage, janitorial, and mechanical, electrical and vertical conveyance equipment rooms, adjoined to, and accessed through, the below-grade vestibule;
 - iii. internal (non-public) circulation linking the building services spaces; and
 - iv. a Utility Complex (the “Churchill Connector Utility Complex”) located contiguous with the building services spaces and accessible through the building services spaces.

5-2.13.3 Pedestrian Circulation Requirements

- A. Provide public vertical and horizontal access and egress facilities for the Churchill Connector, that:
1. provide clear unimpeded paths of travel for pedestrian movements within the physical constraints of the facility;
 2. accommodate a link load of 320 persons per Headway of the Valley Line for the vertical circulation system between the at-grade and below-grade spaces of the Churchill Connector;
 3. are operable independently from the adjoining Pedway and Existing Churchill Station mezzanine circulation, access and egress systems; and
 4. do not decrease the existing level of life safety, building performance or egress capacity of the Existing Churchill Station, including the mezzanine, and the Pedway system.
- B. Provide an environmental separation between the below-grade landing area, including the existing Pedway, and the Existing Churchill Station mezzanine. The separation shall:

1. be able to be secured; and
 2. shall at a minimum perform to the same standards as the existing environmental, security, and fire separation between the existing Pedway and the Existing Churchill Station mezzanine.
- C. At a minimum, provide:
1. two (2) at-grade entrances to the Churchill Connector, one (1) each at the north and south sides of the Churchill Connector sub-vestibule.
 - a. Doors shall:
 - i. be automatic sliding doors;
 - ii. have a clear opening width of at least 1850 mm; and
 - iii. automatically open in case of a door malfunction;
 2. a below-grade connection, between the below-grade landing area and the Pedway system; and
 3. a below-grade connection between the below-grade landing area and the Existing Churchill Station mezzanine.
- D. The underground connections shall provide:
1. unimpeded, fully accessible pedestrian movements to, from, and between each of the above elements; and
 2. a common and coplanar floor level between each of the above elements using the elevation of the Existing Churchill Station mezzanine floor level as the shared baseline.
- E. Design and construct the Churchill Connector pedestrian circulation spaces in a manner that provides:
1. a non-fare paid zone outside the Existing Churchill Station fare paid zone; and
 2. interior queuing space of at least 20 m² at the top of the stairs and escalators connecting the at- and below-grade spaces.
- F. All stairs and escalators shall fall adjacent to, parallel with, and matching the inclination angle of any adjacent stair or escalator with landings at a common level.

5-2.13.4 General Demolition and Construction Requirements

- A. Construct the Churchill Connector without impeding the normal operation of, safe access to, or egress from, any adjoining occupancy or facility.
- B. Construct the Churchill Connector in such a manner that all demolition and construction materials enter and leave the Site only through areas that are hoarded for Construction purposes.
- C. Construction fencing and hoarding at-grade shall be opaque and enhanced with imagery, patterns, and other features complimentary to the overall site context; incorporate South Pavilion tenant name, entrance wayfinding, and "OPEN FOR BUSINESS" onto fencing and hoarding at the north side of the South Pavilion.
- D. Provide access at all times with a minimum functional width of 3.3m from the west to the South Pavilion north entrance.

- E. Maintain a minimum functional width of 3.5m in the existing Pedway connecting into the Existing Churchill Station mezzanine at all times during Construction of the Churchill Connector. After completion of the Churchill Connector, the Pedway width shall be at least 5.5m.
- F. All Infrastructure on Sir Winston Churchill Square that is accessible by vehicle shall be designed for the traffic load specified in Part 4 [*Transportation and Building Structures*] of this Schedule.
- G. Ventilation for the Churchill Connector Utility Complex shall be integrated into landscape features without adding any additional obstruction in Sir Winston Churchill Square.

5-2.13.5 At-Grade Demolition and Construction Requirements

- A. Except as otherwise specified in Sections 5-2.13.5C to 5-2.13.5F below, any existing elements on Sir Winston Churchill Square that are removed during Construction of the Churchill Connector shall be reinstalled in their existing location and condition.
- B. Existing walls of the South Pavilion affected by Construction shall be restored to fulfill their functions, including complying to ABC, water proofing and thermal and sound insulation, as applicable, and to blend in with the surrounding walls of either the South Pavilion or the Churchill Connector.
- C. The following existing elements identified in Figure 5-2.13C [*Sir Winston Churchill Square – Existing Condition*] shall be removed and disposed of:
 - 1. six (6) skylights south and south-west of the South Pavilion:
 - a. infill and any other work required to close the openings of the skylights shall be waterproof and match adjacent construction assemblies;
 - 2. outdoor Enbridge canopy, patio, patio seating and fire place;
 - 3. trees south of the South Pavilion; and
 - 4. any Utilities, such as hydrants, manholes, and cabinets impeding pedestrian flow on the Churchill Stop north Platform or obstructing construction of the Churchill Connector; Utilities shall be relocated as required to keep the respective system operational and in accordance with Section 3-5 [*Utilities*] of this Schedule.
- D. Remove planters in the Pedway under the existing skylights to the ground level of the existing Pedway and install new flooring and wall covering where planters are removed, utilizing flooring and wall covering materials matching the thickness, module size, slip resistance, durability, reflectivity, and finish quality of the existing flooring and wall covering materials in the Pedway adjacent to the planters.
 - 1. Plants and soil will be removed by the City; notify the City sixty (60) days before start of work affecting the planters.
- E. The existing story pole #1 shall be removed and disposed of; the three (3) existing plaques shall be salvaged and mounted to the South Pavilion south face under the Churchill Stop Canopy; all Utility connections within the story pole shall be relocated to the north-west corner of the Churchill Connector pavilion and in accordance with Section 3-5 [*Utilities*] of this Schedule.
- F. Remove the existing condenser unit, including enclosure, serving the South Pavilion and located south of the South Pavilion and:
 - 1. provide a condenser unit on the roof of the Churchill Connector sub-vestibule and screen it from view; the existing unit may be reused;

2. removal and installation of condenser unit shall not adversely impact operation to South Pavilion tenant;
 3. reinstate wall assembly of South Pavilion to match adjacent walls and to fulfill its function, including water proofing and thermal and sound insulation; and
 4. refer to the Disclosed Data for photos of the existing condenser unit.
- G. With the exception of the new donor plaza described in Section 5-2.13.6 [*Donor Plaza*] of this Schedule, all surfaces of Sir Winston Churchill Square shall be reinstated to the same condition as prior to Construction of the Churchill Connector; in particular:
1. horizontal grates are not permitted;
 2. access hatches and openings to spaces below-grade shall be covered with paving materials, colours, textures, and joint patterns to match with the original and to create a continuous and coplanar transition to and joint between adjacent and existing pavement surfaces; and
 3. surface materials, sub-structures and sub-grade preparation shall be consistent with the existing Churchill Square drawings included in the Disclosed Data.

5-2.13.6 Donor Plaza

- A. Provide a new donor plaza northwest of story pole #2 in accordance with the requirements stated in this Section 5-2.13.6 [*Donor Plaza*] of this Schedule.
1. The area of the new donor plaza shall be at least 95m², but no more than 105m².
 2. The new donor plaza shall be defined by a change in surface material, colour, texture, pattern or any combination thereof with respect to the existing plaza surface at Sir Winston Churchill Square, provided that:
 - a. changes in surface texture shall not result in a reduction of the coefficient of friction from the existing plaza surface;
 - b. changes in surface material shall not result in a reduction in durability as compared to the existing plaza surface; and
 - c. changes in surface colour shall be permitted to the extent that the new material colour complements the existing plaza surface colour and other infrastructure found elsewhere at Sir Winston Churchill Square including the South Pavilion, existing story poles, existing ATCO canopy and the Churchill Connector.
 3. The new plaza shall be located to the north of the South Pavilion such that its southernmost boundary line is not less than 7m from any portion of the South Pavilion.
 4. The north limit of the new plaza shall be the south edge of the retaining wall which defines a landscaped area north of the proposed Churchill Connector.
 5. The new plaza shall not have a dimension less than 5m or greater than 20m in either its width or its length.
 6. Above grade infrastructure creating a barrier or a tripping hazard shall not be permitted.
 7. Steps and significant grade or elevation changes shall not be permitted.

8. The design of the new donor plaza must provide for the replacement of the existing placard that is currently mounted to the east wall of the South Pavilion. Horizontal placement of the placard shall not be permitted.
9. The design of the new donor plaza must provide for the placement of lettering which shall read "ENBRIDGE PATIO" and as follows:
 - a. letters shall be all upper case letters;
 - b. letters shall not be less than 250mm in height;
 - c. letters shall be of a typeface and colour that promote legibility;
 - d. lettering shall be placed in a conspicuous location; and
 - e. acceptable lettering formats include pin mounted stainless steel or aluminum letters, or letters etched into hard surfaces.

5-2.13.7 Below-Grade Passenger Flow Improvements

- A. Remove all existing floor-mounted guard railings encircling the fare processing area located at the mezzanine-level landing of the stairway and escalator linking the mezzanine and platform levels of the Existing Churchill Station, as shown in Figure 5-2.13D [*Churchill Connector Construction – Below-Grade*].
- B. Remove all walls, partitions, glazing and door assemblies between the existing Pedway system and the existing mezzanine elevator core in the Existing Churchill Station, as shown in Figure 5-2.13D [*Churchill Connector Construction – Below-Grade*].
- C. Relocate all other amenities, including waste and recycling receptacles, TVMs, Validators, Information Panel, emergency phone, and pedestals with the plaques and statue, in the area between the existing stairway referred to in Section 5-2.13.7A [*Below-Grade Passenger Flow Improvements*] and the partitions referred to in Section 5-2.13.7B [*Below-Grade Passenger Flow Improvements*] to within a radius of 25 m of the existing location of the applicable amenity.
 1. The new location of these amenities shall not adversely affect pedestrian flow and shall be conveniently placed for Passengers.
 2. TVMs, Validators and Information Panel will be removed and reinstalled by the City subject to the provisions of Section 6-1.18 [*Ticket Vending Machine Infrastructure*] and Section 6-1.19.4 [*Information Panels*] of this Schedule.
- D. Install new flooring where required by the Project Work specified in Sections 5-2.13.7A to 5-2.13.7C [*Below-Grade Passenger Flow Improvements*] utilizing flooring materials matching the thickness, module size, slip resistance, durability, reflectivity, and finish quality of the existing flooring materials.
- E. Install new ceilings where required by the Project Work specified in Sections 5-2.13.7A to 5-2.13.7C [*Below-Grade Passenger Flow Improvements*] matching the existing ceiling.

5-2.13.8 Material Requirements

- A. Opaque wall assemblies shall match adjacent and similar existing wall assemblies of the South Pavilion in terms of overall form, colour, and texture but shall be of an overall material, component, and assembly quality, and durability, and incorporate other physical properties, as needed, to match the particular demands of that assembly's service environment.

- B. The following materials and assemblies shall not be permitted to form any part of the Churchill Connector exterior:
1. concrete masonry units of any type or design;
 2. manufactured or “cultured” stone;
 3. “Exterior Insulation and Finishing Systems” (EIFS);
 4. stucco or any other applied cementitious coating or parging;
 5. phenolic resin panels;
 6. faux masonry or stone panels formed from cast-in-place or precast concrete; and
 7. prefinished, preformed or site rolled steel or aluminum sheet, panels, planks, or pans
- C. Sloped roofs serving the main volume of the Churchill Connector shall include gutter and fascia assemblies that match the colour and material quality of, and have a similar assembly type, slope and overall geometry, as those of the existing South Pavilion.
- D. Low slope roof assemblies over the Churchill Connector sub-vestibule shall use parapet flashing, fascia, gutter and exterior downspout assemblies that match the quality and are compatible in every respect with those of the adjoining Churchill Connector main roof.

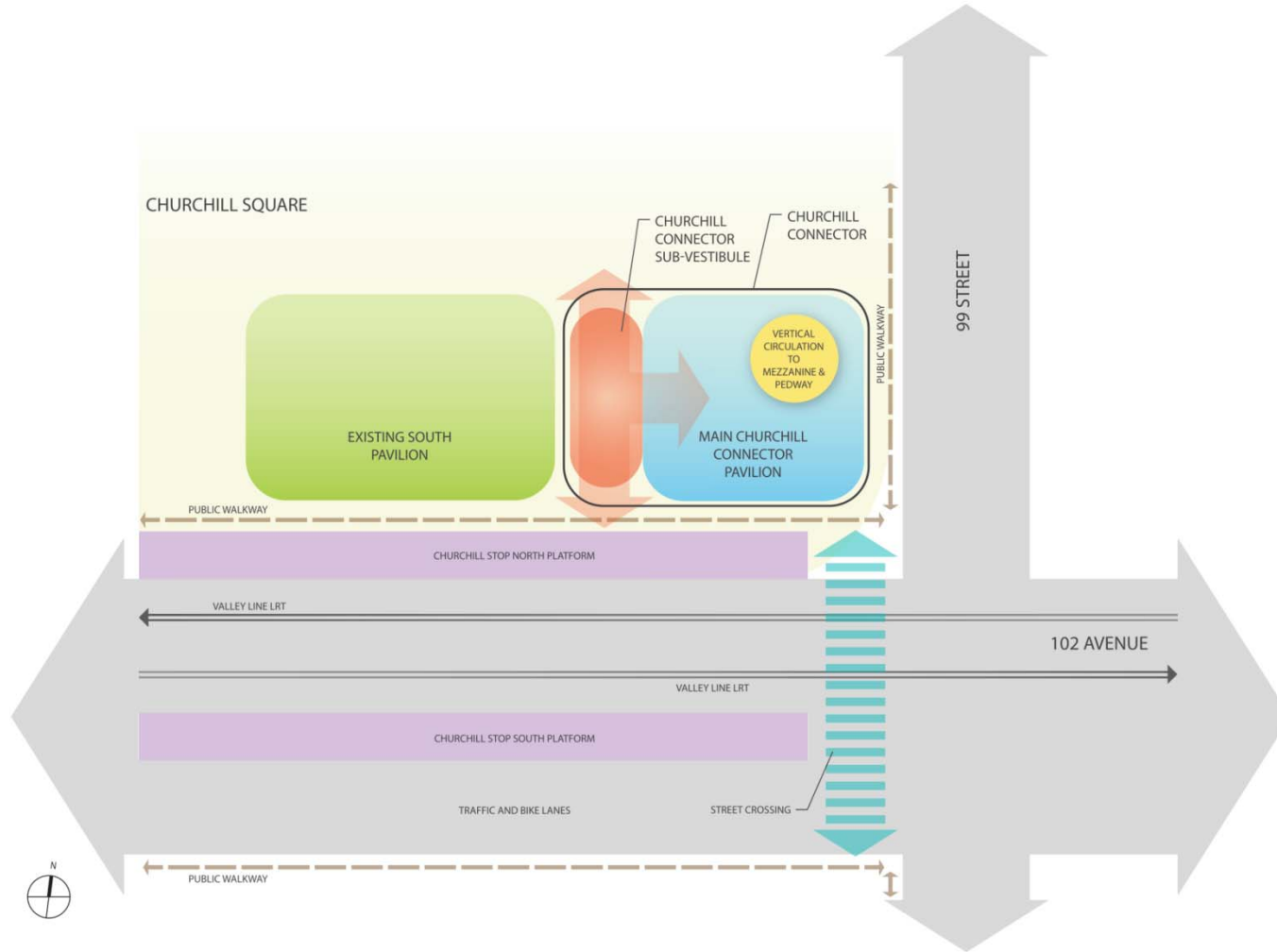

Figure 5-2.13A: Churchill Connector Functional Relationship – At-Grade

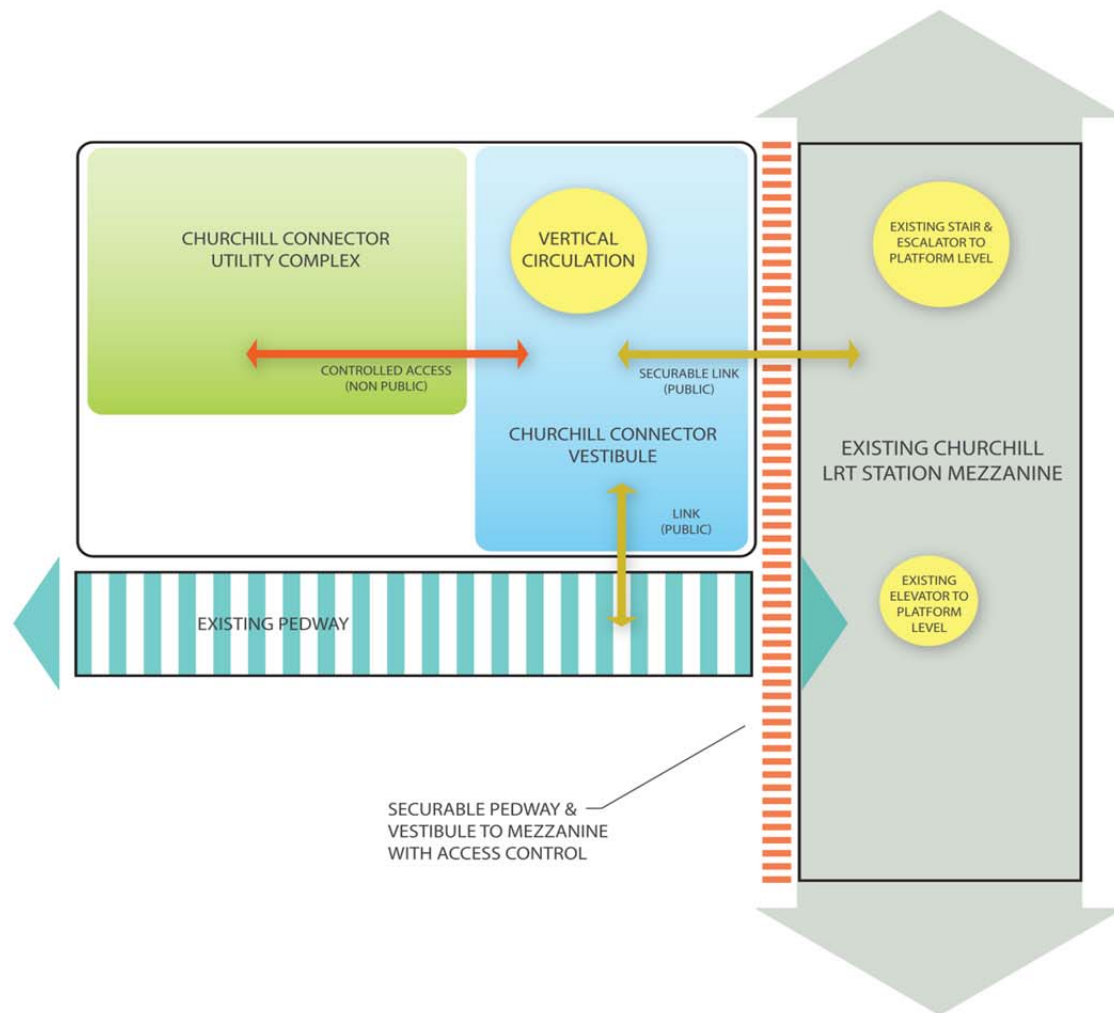

Figure 5-2.13B: Churchill Connector Functional Relationship – Below-Grade

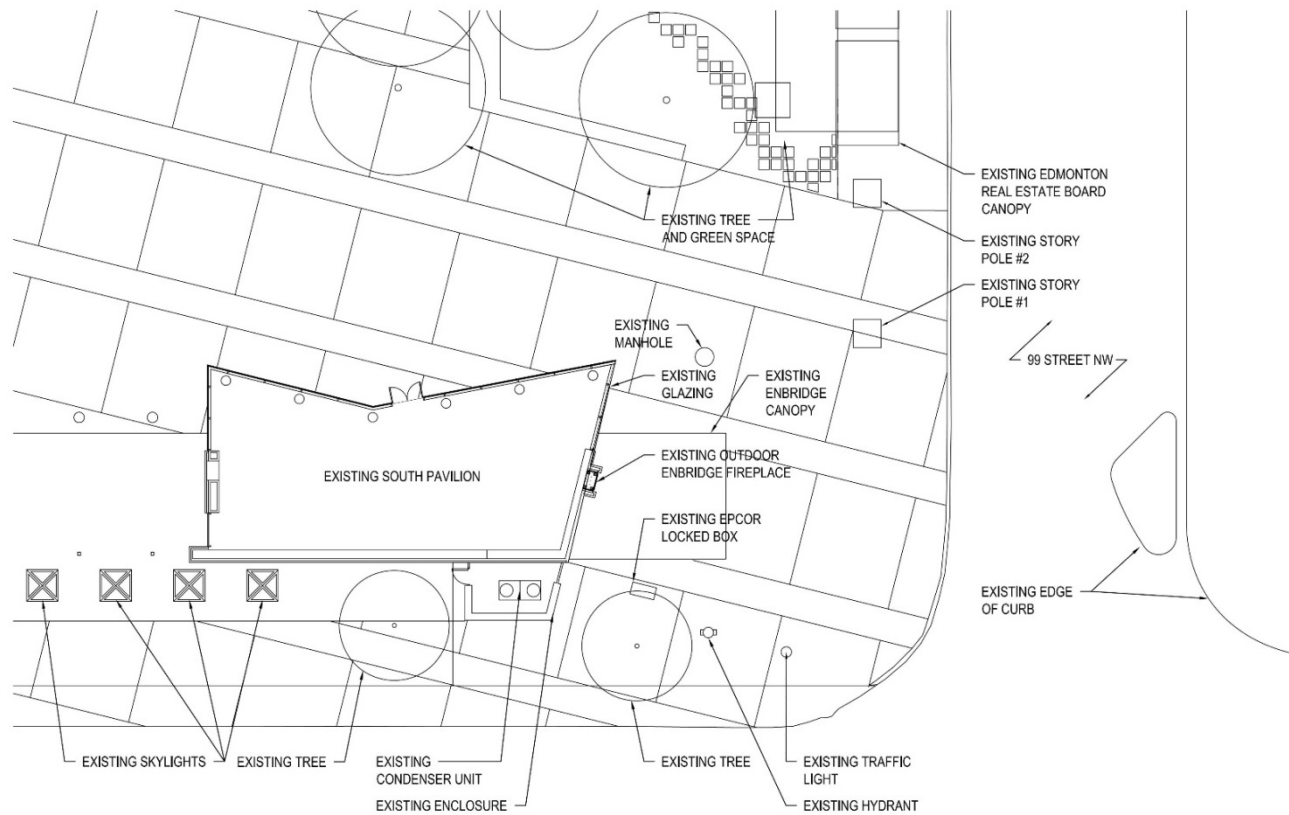

Figure 5-2.13C: Sir Winston Churchill Square – Existing Condition

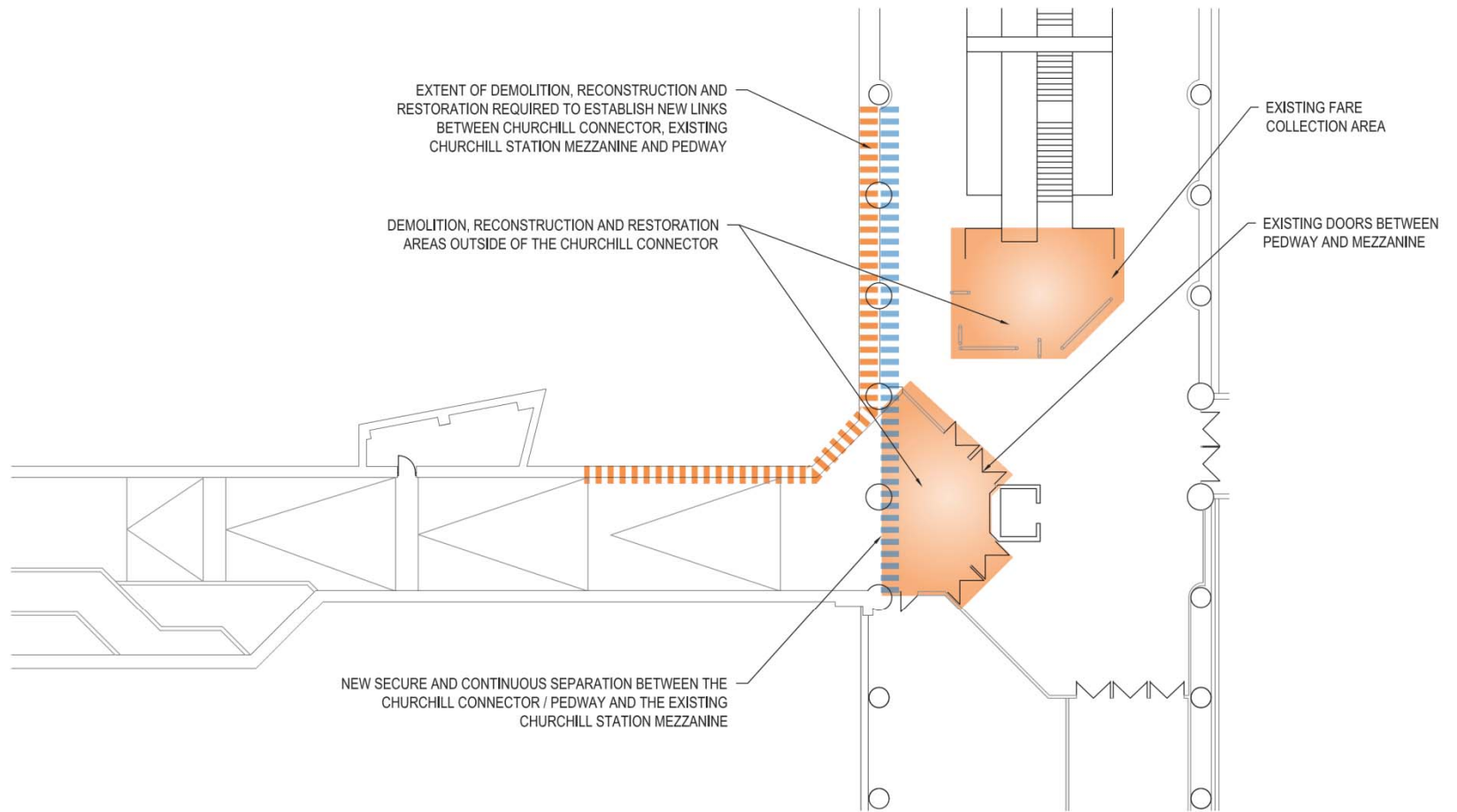

Figure 5-2.13D: Churchill Connector Construction – Below-Grade

SECTION 5-3 GERRY WRIGHT OPERATIONS AND MAINTENANCE FACILITY

5-3.1 INTRODUCTION

- A. This Section 5-3 [*Gerry Wright Operations and Maintenance Facility*] sets out the requirements for the Gerry Wright OMF.
- B. The Gerry Wright OMF is a fully functional operations and maintenance campus comprised of all facilities and equipment required for performance of the functions described in Section 5-3.2 [*Function*] of this Schedule.
- C. Provide access for City Persons to the Gerry Wright OMF Site at all times.

5-3.2 FUNCTION

- A. Design the Gerry Wright OMF for performance of the following functions:
 - 1. all scheduling, monitoring and management of Operations and Maintenance activities;
 - 2. routine maintenance of LRVs;
 - 3. delivery and offloading of LRVs and other On-track Vehicles;
 - 4. staging and marshalling of all LRVs and other On-track Vehicles; and
 - 5. any other functions specified to be located at, or performed from, the Gerry Wright OMF.

5-3.3 DESIGN AND CONSTRUCTION REQUIREMENTS

5-3.3.1 General Requirements

- A. Except as otherwise specified in this Section 5-3 [*Gerry Wright Operations and Maintenance Facility*] of this Schedule, all equipment, components, materials, systems, and sub-systems forming part of the Gerry Wright OMF shall comply with the applicable requirements specified elsewhere in this Schedule, including:
 - 1. Roadways;
 - 2. vehicle parking;
 - 3. site contouring and drainage;
 - 4. retaining walls;
 - 5. Utility relocations; and
 - 6. Structures.
- B. The Gerry Wright OMF shall be designed as a singular campus.
- C. All administrative spaces within the Gerry Wright OMF shall be designed and constructed to a standard commensurate with normal North American standards for office facilities.
- D. The Gerry Wright OMF, including all Shop Track and Yard Track, shall be designed to accommodate a minimum static vehicle width of 2.65m.
- E. All Structures and any OCS within the Gerry Wright OMF Site shall be designed to accommodate On-track Vehicle heights up to 4.0m, as measured with the pantograph in the lowest operating position.

5-3.3.2 Sustainability and LEED®

- A. All maintenance shop(s) and all administrative areas, including the City Office, the OCC and the main Data Centre, at the Gerry Wright OMF, shall obtain LEED Silver Certification in accordance with Section 4.5 [*LEED Silver Certification*] of Schedule 4 [*Design and Construction Protocols*].

5-3.3.3 Design and Construction Capacity

- A. The Gerry Wright OMF shall be arranged such that all On-track Vehicles, including 100% of the LRVs, required for Operation at the Maximum Service Level can be concurrently staged, marshalled and stored within that portion of the Gerry Wright OMF Site identified as Parcel "A" in Figure 5-3.7 [*Gerry Wright OMF Site*] of this Schedule.
- B. The Gerry Wright OMF, including:
1. all systems for distribution of Traction Power in accordance with Section 6-2.5 [*Shop TPSS and Yard TPSS*] of this Schedule;
 2. all Yard Track and Shop Track;
 3. all storage, marshalling and staging areas for On-track Vehicles and other vehicles required for Operations and Maintenance;
 4. all administrative areas, including the OCC, City Office, the main Data Centre;
 5. all LRV maintenance shop(s);
 6. all areas required for application of advertising, including vinyl wraps, in and on LRVs in accordance with Section 7.6 [*External Advertising on LRVs*] of Schedule 7 [*O&M Performance Requirements*]. Application of advertising will be by Other Contractors;
 7. all storage areas for Critical Spares and other spare parts, tools and equipment;
 8. three (3) assigned parking stalls, within 30m of the main entrance to the administration area, for exclusive use by City Persons; and
 9. any other facilities, equipment, systems, and sub-systems,

as required for Operation and Maintenance at the Maximum Service Level, shall be constructed within that portion of the Gerry Wright OMF Site identified as Parcel "A" in Figure 5-3.7 [*Gerry Wright OMF Site*].

- C. Stormwater Management Facilities required for the Gerry Wright OMF Site may be constructed within that portion of the Gerry Wright OMF Site identified as Parcel "C" in Figure 5-3.7 [*Gerry Wright OMF Site*]. Connections for Stormwater Management from Parcel "A" may be constructed through Parcel "B" subject to compliance with Schedule 28 [*Approvals, Permits and Authorizations*].

5-3.3.4 Expansion Design Capacity Requirements

- A. Concurrently with submission of the Final Design package for the Gerry Wright OMF, provide:
1. a design consistent with the "design development phase", as outlined in the document entitled "Schedule of Designated Services for Recommended Conditions of Engagement and Schedule of Suggested Professional Fees for Building Projects", published by the Alberta Association of Architects;
 2. a detailed design of all expansion interfaces; and

3. a detailed construction sequencing plan,

demonstrating how Project Co would expand the Gerry Wright OMF, including any maintenance shops, administrative areas, OCC, Data Centre(s), staging, marshalling and storage facilities, Traction Power distribution, and other facilities and infrastructure on the Gerry Wright OMF Site, required to support operation and maintenance of an expanded Valley Line system without any adverse impact on the Operation and Maintenance of the System (collectively, the “**Expansion Design**”). For the purpose of this Section 5-3.3.4 [*Expansion Design Capacity Requirements*], the Expansion Design shall be based on:

4. a continuous double-track extension of the corridor of approximately 14.0 km from the 102 Street Stop west to Lewis Farms, with an additional fourteen (14) Stops and two (2) Stations; and
 5. concurrent marshalling, staging and storage of a number of LRVs equal to 200% of the LRVs required to Operate the System at the Maximum Service Level.
- B. The Expansion Design shall use only those portions of the Gerry Wright OMF Site identified as Parcel “A” and Parcel “B” in Figure 5-3.7 [*Gerry Wright OMF Site*] and shall maintain the singular campus design.

5-3.4 OPERATIONS CONTROL CENTRE

- A. The OCC is a self-contained operations control facility located within the Gerry Wright OMF, that includes all interfaces, equipment, systems and sub-systems required for the performance of the activities defined in Section 7.4 [*Operations Control Centre*] of Schedule 7 [*O&M Performance Requirements*], or otherwise specified to be included in the OCC.
- B. Without limiting Section 5-3.4A [*Operations Control Centre*], the OCC shall include:
1. sufficient operational space, desks, seating, workstations, and communication consoles for the OCC operators, supervisors and support staff required to Operate and Maintain the System;
 2. reliable cellular phone coverage such that commercial 3G mobile services from at least one (1) service provider are dependably available from all operational spaces and desks within the OCC;
 3. minimum twelve (12) CAT-6 cable communication outlets cabled to the main Data Centre; and
 4. wall, ceiling and floor finishes commensurate with adjacent office areas.

5-3.5 CITY OFFICE

- A. Provide one (1) office within the administrative area of the Gerry Wright OMF for the exclusive use of the City (the “**City Office**”). The office shall be commensurate with normal North American standards for offices and shall have:
1. a minimum useable floor area of 25m², with no walls shorter than 4m in length, and be functionally capable of use by three (3) City Persons concurrently working at workstations;
 2. a finished ceiling with a minimum clear height to obstructions of 2.4m;
 3. a composite Sound Transmission Class (STC_C) of 40 or greater for all walls, floors and ceilings;
 4. a solid door and secure frame with no glazing or side-lites;
 5. heavy duty door hardware with deadbolts. Provide all keys to the City;

6. card access security in accordance with Section 6-1.16 [*Security and Alarm*] of this Schedule., The City Office shall not be accessible to Project Co Persons.
 - a. if restricted card access is provided to enter the Gerry Wright OMF Site, provide one hundred (100) access cards to the City programmed to allow 24/7 entry by City personnel;
7. thermostatic control to maintain all office spaces within a range of 19°C to 22°C at all times;
8. adjustable humidity control to electronically maintain all office spaces between 30% RH and 50% RH at all times;
9. adjustable room lighting (between 0 – 500 lux);
10. six (6) Cat-6 communications outlets cabled to the City-FDF rack in the main Data Centre;
11. reliable cellular phone coverage such that commercial 3G mobile services from at least one (1) service provider are dependably available from all work spaces within the office;
12. space for three (3) workstations (workstations to be supplied by Other Contractors), each with one (1) x 4plex 120V outlet, one (1) of which shall be energized from the building UPS; and
13. wall, ceiling and floor finishes commensurate with adjacent office areas.

5-3.6 MAIN DATA CENTRE

Provide one (1) office Data Centre within the administrative area of the Gerry Wright OMF meeting the requirements set out in Section 6-1.9 [*Data Centres*] of this Schedule.

5-3.7 SITE CONSTRAINTS

- A. The Gerry Wright OMF Site is as illustrated in Figure 5-3.7 [*Gerry Wright OMF Site*].
- B. Provide road vehicle access from 51st Avenue only.



Figure 5-3.7: Gerry Wright OMF Site